

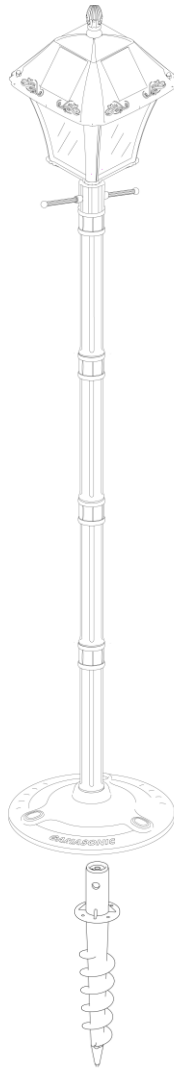

BAYTOWN II
SOLAR LAMP POST
US Patent # 7172307
Patent Pending DIY Installation
For Solar Lamp Post

Instruction Manual

Model: GS-105SG



Visit our website or download the latest version of your instruction manual:
www.gamasonic.com or www.gamasonic.com/user-guides

Introduction

Thank you for your purchase. **GAMA SONIC®** solar charged accent lighting eliminates the problems associated with most solar lighting available today. **GAMA SONIC®** solar charged lights are brighter and last all night with a typical solar charge. Unique design, superior light output and numerous installation options confirm the outstanding value of our product.

GAMA SONIC® has been recognized as a worldwide leader in the lighting industry for over 20 years. The company also offers unique multi-purpose rechargeable products that range from party lights to emergency lighting products.

For technical assistance and more information call our Toll Free number: 800-835-4113 (only within the US) or visit our website at: www.gamasonic.com.

Please read the instruction manual carefully to obtain the best results from your purchase.

1. Solar Lamp Post Location

For optimum light duration throughout the night, it is very important to place your solar lamp in a spot where it will receive the maximum amount of direct sunlight throughout the day.

NOTE: For best results, the solar lamp post must be charged for two sunny days on the “ON” position,

2. Assembly Instructions:

1. Attach the body(B) to the stem(D) with the four supplied screws, as shown.

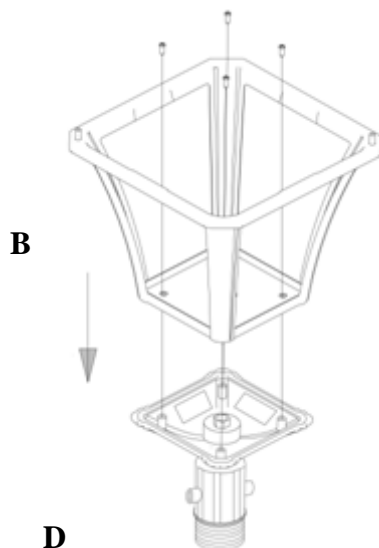

2. Place the lens and cone(C) in the body(B).

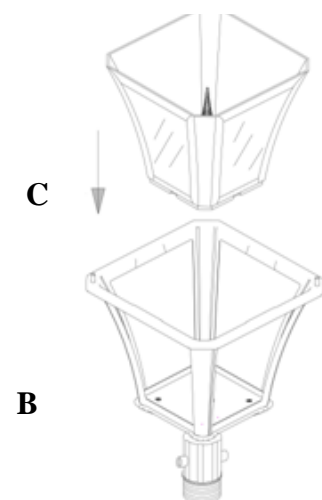

3. Turn on switch to desired setting.

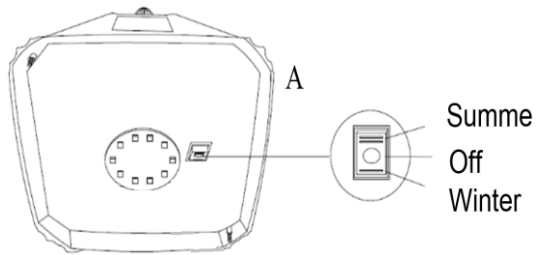

4. Attach top(A) to the body(B) with the two supplied screw caps.

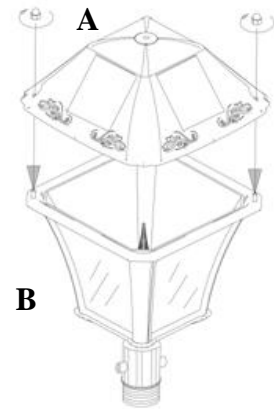

5. Attach Side handles provided.

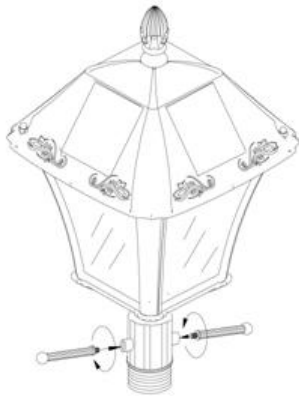

6. Screw on top Ornament.

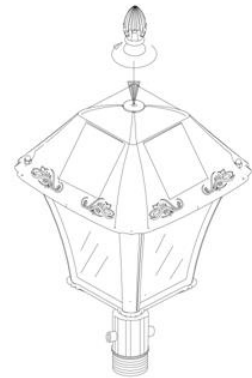

7. Assemble pole by screwing the four pieces together.

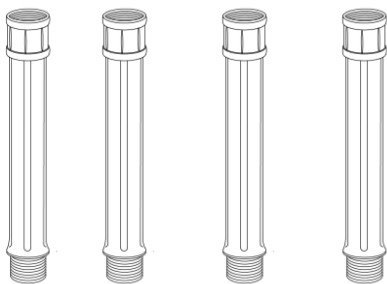

**Two easy ways for installation:
 Flat mount (8.1 - 8.2)
 EZ Anchor (9.1 - 9.7)**

Flat installation (Installing the lamp post without anchor):

8.1 Mark three holes with the base plate as a template. With an electric drill, drill the holes into concrete. Assemble with the hardware provided.

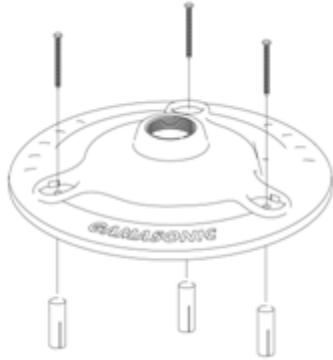

8.2 After assembling attach the three decorative caps provided and screw the fixture to the base.

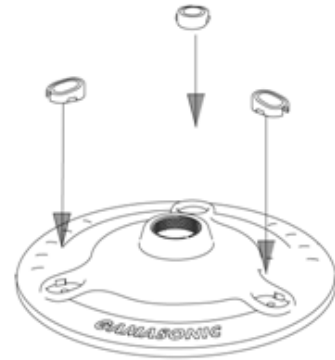

EZ Anchor Installation Instructions:

9.1 Attach Part (E) to Part (F) Using the four small screws from, as shown.

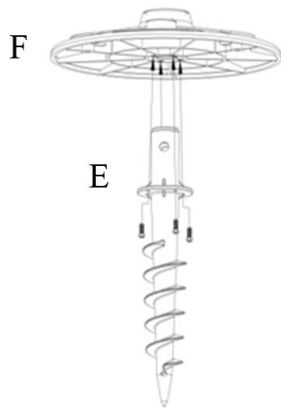

9.2 Insert the Turning bar (G) in the hole through the anchor stake (H) as shown.

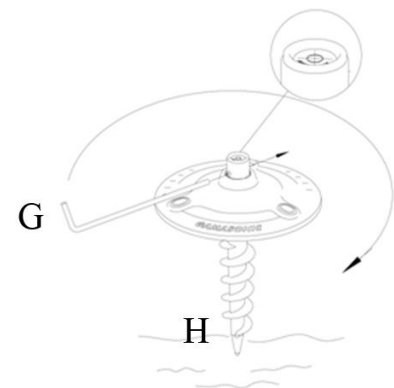

9.3 Place anchor in desired location and apply downward pressure while turning the Turning bar clock wise.

9.4 Occasionally check the anchor Level Tool to ensure your digging is straight.

9.5 Stop turning once Part (I) is flat with ground level.

9.6 Remove the Turning Bar(G).

9.7 Screw the fixture to the Anchor.

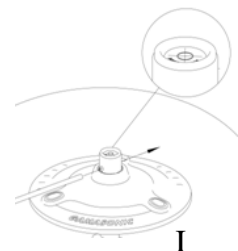

3. Operation Instructions

1. Remove the top (A) by unscrewing the 2 screw caps. Turn the operation switch to “summer” (for greater brightness) or “winter” (for longer duration) position. The Solar Lamp will automatically operate at dusk.
2. Reattach top (A) and secure with the 2 screw caps.

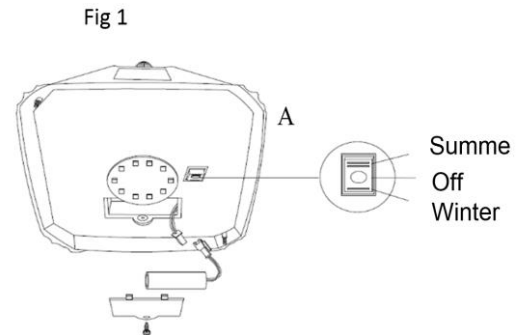

4. Batteries

Read carefully the next section. Here you will learn how to add a secondary battery (optional), and how to replace your existing battery once it exceeds its life span.

a. Secondary Battery (Optional)

Our **GS-105** model features two (2) battery compartments (**Fig.2**). This light comes with one (1) pre-installed battery (included), and you have the **OPTION** to add a second battery. This is a unique feature designed to give you more choices to prolong the duration of your solar light.

Use this option if your light is exposed to the sun for more than 4 hours a day. Shorter exposure will **NOT** charge the second battery and therefore it is not necessary.



Fig.2

b. Adding Secondary Battery

(This solar light allows you to add a secondary battery. Follow the below instructions to install it.)

1. Unscrew the two screw caps and detach the top **(B)**. Make sure the ON/OFF switch is in the OFF **(O)** position.
2. Unscrew the battery compartments screws located on the silver reflector and remove the compartment's door to locate the empty compartment **(Fig.2)**.
3. Make sure the battery is a [Gama Sonic - 3.2V/1,500mAh](#), Li-ion Rechargeable Battery with a connector.
4. Clip on the new additional battery and install it into the battery compartment. Screw back battery compartment screw. Reattach the top and secure it with the two screw caps.



c. Replacing the Battery

(After several years of use, the battery may need replacing.)

1. Unscrew the two screw caps and detach the top **(A)**. Make sure the ON/OFF switch is in the OFF **(O)** position.
2. Unscrew the battery compartment **(Fig.2)** screw located on the silver reflector and remove the compartment door.
3. Unclip the connector and remove the old battery **(Fig.4)**. Make sure the new battery is a Gama Sonic - 3.2V/1,500mAh, Li-ion Rechargeable Battery with a connector.
4. Clip on the new battery and install it into the battery compartment. Screw back battery compartment screw.
5. Reattach the top and secure it with the two screw caps.

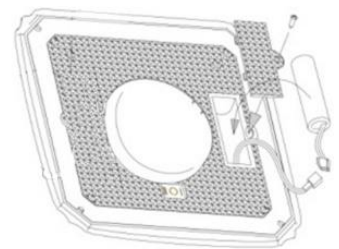

**** Batteries are available at www.gamasonic.com**

You can purchase it directly at: <https://gamasonic.com/product-category/parts-and-accessories/> . Make sure the new battery is a [Gama Sonic - 3.2V/1,500mAh](#), Li-ion Rechargeable Battery with a connector.

WARNING: Do not dispose of Li-Ion battery in the regular trash, municipal waste stream or by fire as batteries may leak or explode. Do not open, short circuit, or mutilate batteries as injury may occur. Preserve our environment by recycling Li-Ion batteries or disposing of them in accordance with local, State and federal regulations. Do not mix old and new batteries.

MAINTENANCE: Clean the solar panels regularly with a damp towel to guarantee optimum performance. Do not use any type of solvent for cleaning and be careful not to put too much pressure on the solar panels while cleaning.

TROUBLE SHOOTING: If your solar charged light does not come on at dusk despite observance of all the instructions, please try the following steps:

1. Make sure that the solar lamp is not being affected by any other light source.
2. Ensure the solar lamp is not positioned in the shade during the day.
3. Make sure the switch on the lamp head is in either the Low or High position.
4. Check that the batteries are installed correctly.

NOTE: The performance of the solar lamp will vary with the time of year. It will deliver more light when it has had a full day in the sun rather than a day in overcast weather.

WINTERTIME TIPS: For optimal performance, be sure to remove any snow or debris accumulation from solar panel(s). A solar panel free of debris will charge the batteries much more efficiently.

WARNING: Please keep out of reach of children.

