

INSTALLATION INSTRUCTIONS FOR ONE-WAY / DOUBLE TRAVERSE ROD (Drop In)

- PARTS LIST**
- | | | | |
|-------------------|---------------------------|-------------------|-------------------|
| 1. Pulley Housing | 3. Inside Section of Rod | 5. Center Support | 7. Slide |
| 2. End Bracket | 4. Outside Section of Rod | 6. Cord | 8. Master Carrier |

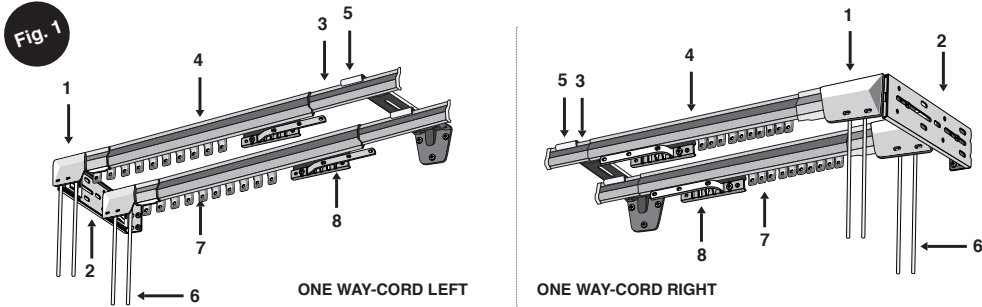

1 MOUNTING INSTRUCTIONS: Wall mount option- Mount the one end bracket and one support to the wall at desired location. No center support is needed for installations less than 50" long. Ceiling mount option- If rod is to be installed to the ceiling, attach pulley housing (without brackets) and stirrup

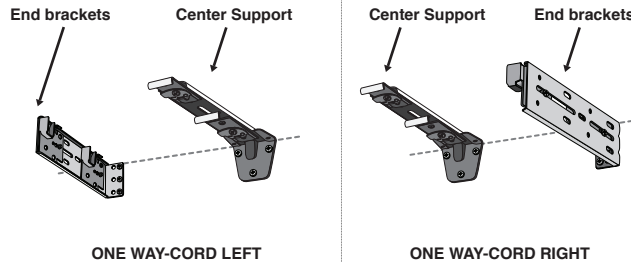

2 FOR RODS FULLY EXTENDED TO 50" OR MORE, INSTALL CENTER SUPPORT.

3 INSTALL ROD INTO END BRACKET : drop end of rod into the u-shaped clip of the end bracket. To remove rod from bracket simply lift the rod out of the u-shaped clip. Attach Rod into center support by turning silver color bracket wheel.

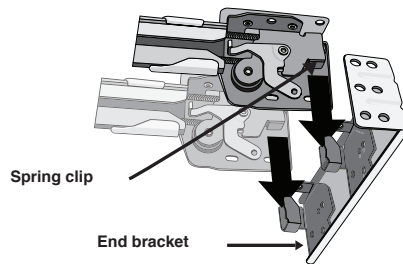

4 ATTACH ROD INTO CENTER SUPPORT BY TURNING SILVER COLOR BRACKETS WHEEL

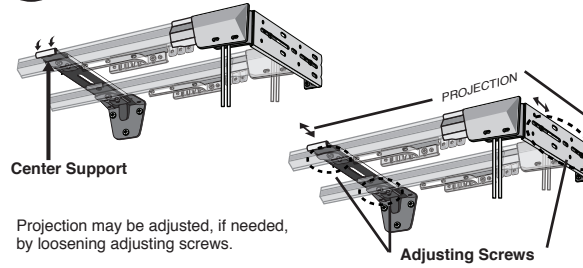

Projection may be adjusted, if needed, by loosening adjusting screws.

ATTACH SUPPORT TO THE ROD

The support arm goes over the top of the rod with the silver cam lock toward the floor. The rod fits into the arm hook and locks in by turning the cam lock with a flat bladed screwdriver. Do not turn the Philips screw.

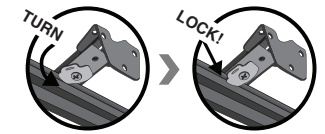

5 REMOVAL OF UNUSED CARRIER SLIDES - PUSH UP THE END GATE TO REMOVE CARRIER SLIDES.

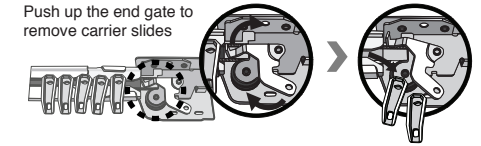

6 CHILD SAFETY CORD GUIDE: RODS WILL NOT WORK PROPERLY WITHOUT GUIDE INSTALLED

Guide is pre-attached to the cord. Mount the guide to the wall at the desired height using the included screw. Tighten the screw until the cord slides through the device freely. (See Fig. 1) Remove excess slack on the cord by grasping and pulling down on the knot that is on the back side of the master carrier. Pull the knot out until the cord is taught in the guide. Tie a new knot into the cord as close as possible to the master carrier and cut off the excess cord. (See Fig. 2)

CHILD SAFETY CORD GUIDE REMOVAL: Pry open the three clips on the back of the device. (See Fig.3) Split the guide open and remove the cord guide.

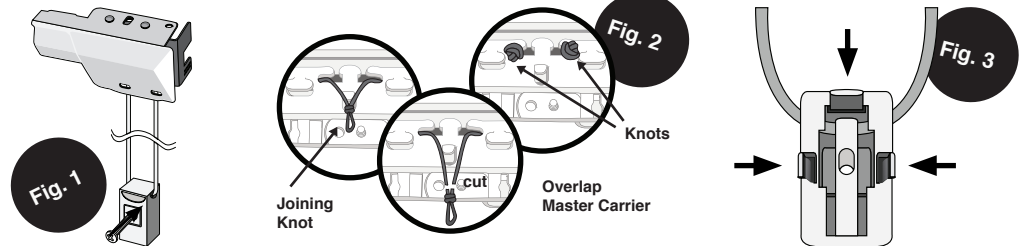

7 HANG DRAPERIES

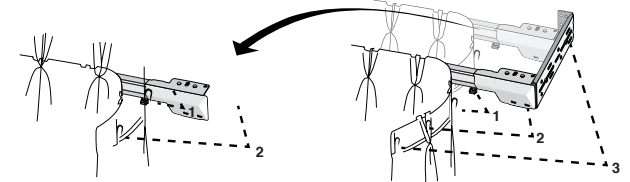

SPECIAL INSTRUCTION

1. TENSION PULLEY OPTION : can be mounted to the wall or floor. After securing Tension Pulley to desired location, loop cord onto pulley wheel. Grasp cord joining knot behind Master Carrier and pull out enough cord to take up slack between the rod and the cord tension pulley. (Fig. 2) Retie knot as close to the Master Carrier as possible then cut off excess cord beyond knot. Rotate pulley head until cords are in proper alignment and release into pulley base.

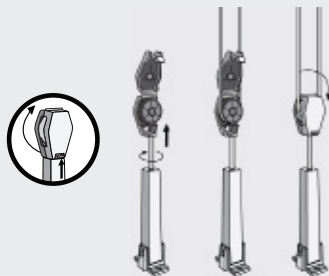

2. CEILING INSTALLATION. If rod is to be installed to ceiling, attach pulley housings (without brackets) and stirrup portion of center support directly to ceiling.

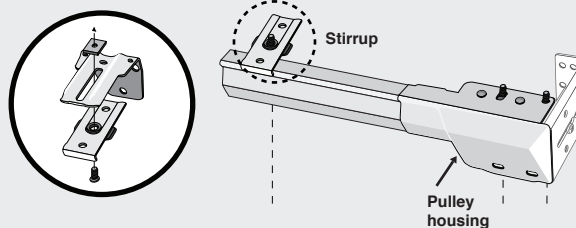

WARNING
TO AVOID POSSIBLE STRANGULATION, KEEP CORDS OUT OF REACH OF CHILDREN. USE THESE DEVICES:

