



- Environmentally friendly material
- Good thermal insulation
- Wide service temperature range
- Bright and long-life colors
- Enables curved roofing (cold bending)
- Rust free
- Lightweight and easy to install
- Impact and UV resistant

Features and Benefits:

SUNTOP is a unique Palram product based on an in-house technological breakthrough that yields a foamed, low-density polycarbonate sheet. SUNTOP combines rigidity, impact resistance and lightweight, with a service temperature range beyond any environmental yearly temperature range.

The Ultimate in Performance and Durability.

SUNTOP
Corrugated Foamed Polycarbonate Sheet

Available in Three Opaque Colors



• Rain Forest Green
No Light Transmission



• Castle Gray
No Light Transmission



• Sedona Brick
No Light Transmission

2 Standard Sizes

• 26" W x 8' L • 26" W x 12' L

Note: 26" panel covers 24" with 1 corrugation overlap.

WoodTite 1" or 2" for installation with wood framing
MetalTite 1" or 2" for metal framing



Special EPDM Washered Fasteners

Foam - 3'L
Wood - 2'L *
Plastic - 2'L
Closure Strip
Horizontal
SUNTOP

SUNTOP
Side Ridge
4'2"L x 7"W



SUNTOP
Ridge Cap
4'2"L x 12"W



SUNTOP
Wall Connector
4'2"L x 8"W



SUNTOP
Vertical
Closure Strip
Wood - 2'L *
Plastic - 2'L

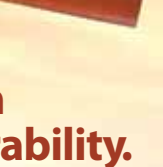

SUNTOP
Horizontal
Closure Strip
Plastic - 2'L *
Wood - 2'L

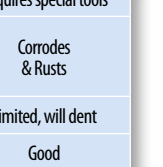

Accessories to Complete Your Project

SUNTOP

The Ultimate in Performance and Durability.

Feature	SUNTOP	METAL
Thermal Insulation	Good	Poor
Weight	Light	Heavy
Handling & Installation	Easy Requires ordinary tools	Difficult Requires special tools
Long Term Corrosion/ Rust Resistance	Will Not Corrode, Rust, Peel or Tear	Corrodes & Rusts
Impact Resistance	Good	Limited, will dent
Hail/Wind Resistance	Good	Good
Warranty	10-Year	Limited

Typical Uses Around The Home & On The Farm

- Car ports
- Deck covers
- Patio covers
- Shade canopies
- Boat deck canopies
- Awnings
- Fences
- Tool sheds
- Horse arenas
- Firewood storage covers
- Camping canopies
- Out buildings
- Garbage enclosures
- Mobile home roofovers
- Stables
- Cabanas

Just a few ideas of what you can do with SUNTOP Corrugated Panels!



SUNTOP
CORRUGATED FOAMED POLYCARBONATE SHEET

10 Year Warranty

SUNTOP Foamed Polycarbonate Panels are warranted against fading for a period of 10 years from the purchase date, not to lose more than 5% of their original color (when tested in accordance with ASTM E-308). The above warranties shall apply only if the panels are installed, used and maintained in accordance with Palram recommendations and specifications. See complete warranty, available from Palram Americas, for details.

Distributed by:

SUNTOP

Corrugated Foamed Polycarbonate Sheet



9735 Commerce Circle • Kutztown, PA 19530
www.PalramAmericas.com

Before You Begin

Make sure the color of all panels match. Be sure Panel and Horizontal Closure Support Strip fit together... SUNTOP Polycarbonate Panels are round. Snow, wind and weather loads should be considered when designing the slope degree of your structure (Min. 1½" in 12"). Before installation, check local building codes for relevant specifications and recommendations. Follow local codes at all times.

TRANSPORTATION, handling and storage: For outdoor storage, cover securely with a white opaque polyethylene sheet to avoid solar heat gain between the panels. Penetration of water between the sheets in storage will accentuate this heat gain. Therefore it is recommended to store the panels indoors. Panels will withstand heat when properly installed and ventilated. Store the panels stacked evenly on a horizontal flat surface with longer lengths on the bottom. Do not stack other items on top of panels. If panels are not stacked directly on floor, be sure to support evenly.

LOAD SUPPORT TABLE	Pounds per Sq. Ft.	25 psf	30 psf	40 psf
Suntuf Purlin Spacing		24"	16"	12"

FLEXIBLE ENOUGH FOR CURVED STRUCTURES: SUNTOP panels may be used in curved applications, as long as the radius of the curve is not less than 20 feet.

SUNTOP ACCESSORIES

- SUNTOP Ridge Cap Flashing 4' 2" L x 12" W
- SUNTOP Side Ridge Flashing 4' 2" L x 7" W
- SUNTOP Wall Connector Flashing 4' 2" L x 8" W
- SUNTOP Vertical Closure Strip Plastic - 7/8" H x 1-3/16" W x 24" L
Wood - 7/8" H x 1-3/16" W x 24" L*
- SUNTOP Horizontal Closure Strip Plastic - 3/4" H x 7/8" W x 24" L
Foam - 3/4" H x 7/8" W x 36" L
Wood - 3/4" H x 7/8" W x 24" L*
- Special EPDM Washered Fasteners

*Available in select markets only.

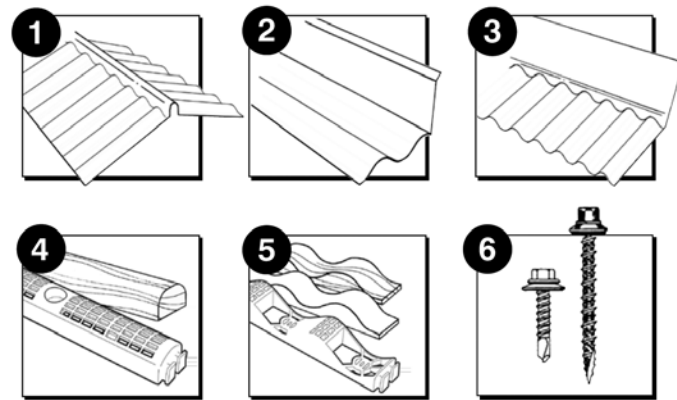

See information below

BE SURE TO CAREFULLY READ ALL INSTRUCTIONS

Installation details for a typical canopy structure

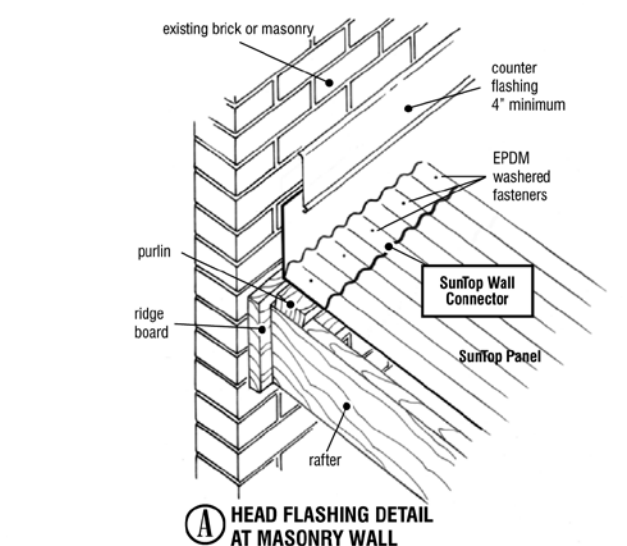

A HEAD FLASHING DETAIL AT MASONRY WALL

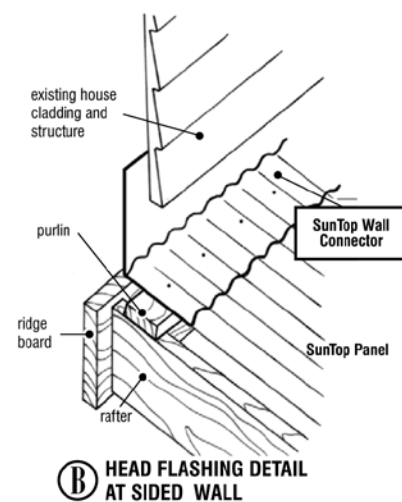

B HEAD FLASHING DETAIL AT SIDED WALL

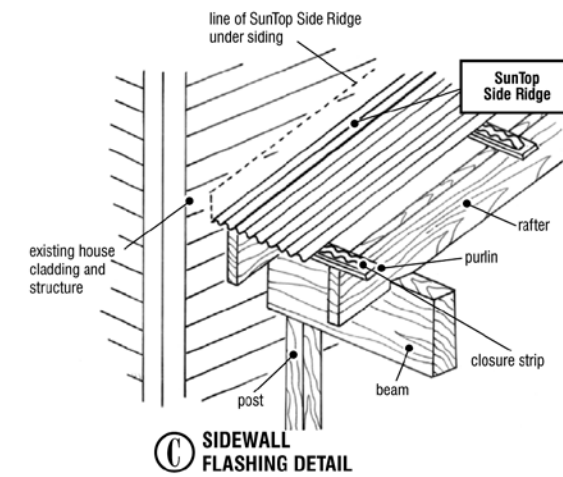

C SIDEWALL FLASHING DETAIL

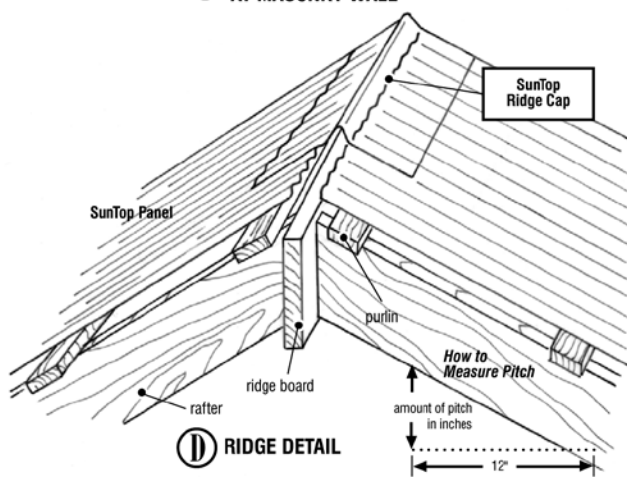

D RIDGE DETAIL

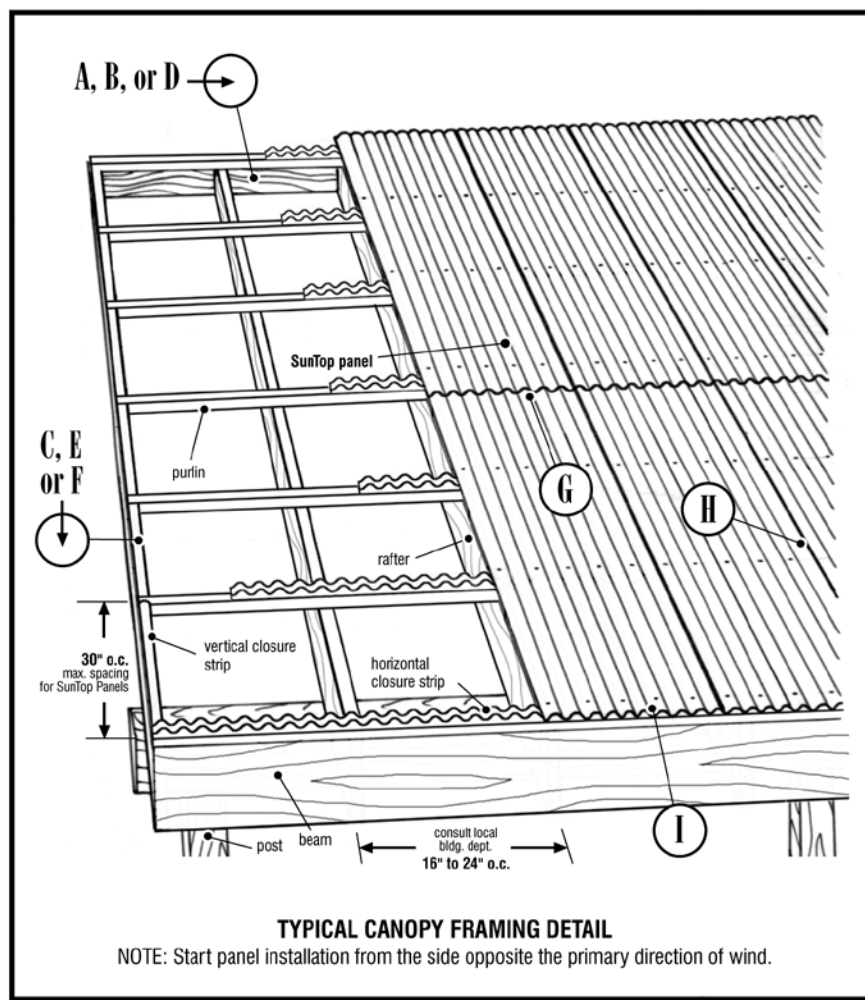

TYPICAL CANOPY FRAMING DETAIL

NOTE: Start panel installation from the side opposite the primary direction of wind.

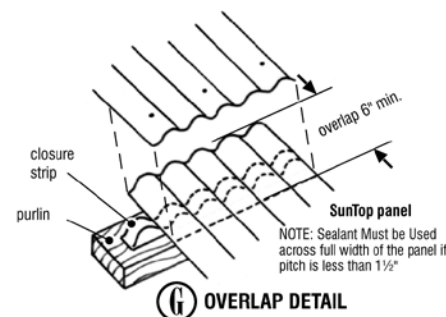

G OVERLAP DETAIL

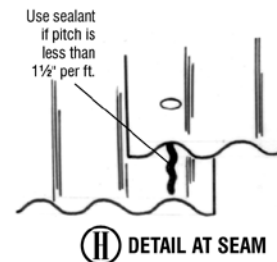

H DETAIL AT SEAM

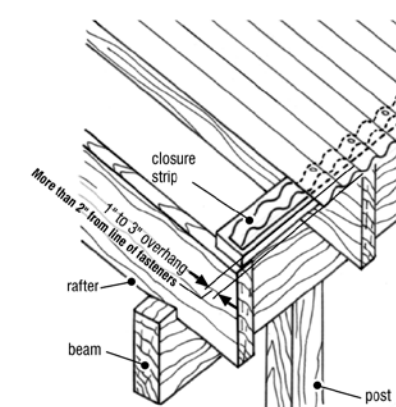

I BOTTOM CLOSURE DETAIL

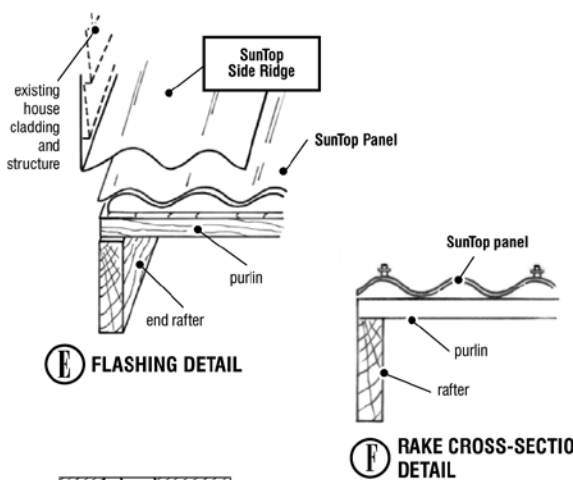

E FLASHING DETAIL

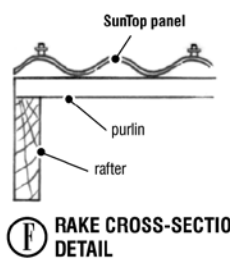

F RAKE CROSS-SECTION DETAIL

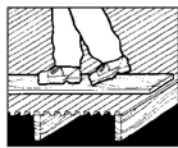

SAFETY
Never walk on sheets, use a board placed across at least 3 rafters to spread the load.

INSTALLATION NOTES:

Install panels with the label side facing toward the sky (sheet corrugations at each end will face down).

To Cut Panels: Use either a circular saw with a plywood blade reversed. Support the sheets to avoid vibration and cut at slow speed. Up to five panels can be cut with a circular saw.

Pitch: This is the amount of height in inches the rafter rises over a 12" run. Minimum slope is 1½" in 12" (see figure D). Never install panels on flat roofs.

Purlins/Cross Supports: Cross supports (purlins) must be no more than 30" apart. Cross Supports should be at least 2" x 2" lumber.

Closure Strips: Made from either plastic, wood or foam, corrugated horizontal closure strips are required. They are used horizontally under the panels as fastener supports. Wood or plastic corrugated horizontal Closure Strips are recommended. Wood or plastic vertical Closure Strips are recommended for finishing the outside edges.

Fasteners: Use Palram Special EPDM Washered fasteners only. NEVER use nails. Pre-drill all fastener holes with a 3/16" drill bit to accommodate for the thermal movement of the panel. Failure to accommodate thermal movement will cause buckling of the sheet. Attach fasteners on the crown of every other rib in the horizontal direction. In high wind areas, fasten on the crown of every rib. Use 2" fasteners for all roof applications. DO NOT Overtighten Fasteners causing the rubber washer to compress.

TIP: Tighten all fasteners until they are "snug". If the black EPDM washer becomes deformed, the fastener is too tight!

Sealants: For Suntuf sheets, it is recommended you use any sealant adhesive that is recommended for polycarbonate materials (see figure H).

Care And Maintenance: Avoid contact with chemicals, paints, adhesives or other synthetic materials that are incompatible with polycarbonate. Never use glass cleaners with ammonia, or ammonia based products. Clean with lukewarm soapy solution using a soft cloth or sponge. Do not use abrasive brushes as these will mark the surface, as these will mark the surface.

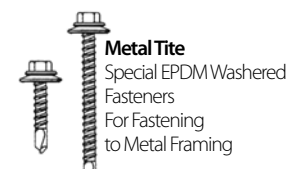

Metal Tite
Special EPDM Washered Fasteners
For Fastening to Metal Framing



Wood Tite
Special EPDM Washered Fasteners
For Fastening to Wood Framing

Inasmuch as Palram Americas has no control over the use (and/or Installation method) to which others may put this material, it does not guarantee that the same results as those described herein will be obtained. Each user of the material should make their own test to determine the suitability of the material for their own particular use. In the event of a warranty claim for product failure, Palram Americas reserves the right to inspect any or all of the sheets involved and the installation site itself while the sheets are still in their original position and have not been removed or moved or altered in any way. For a complete copy of the SUNTOP Polycarbonate Warranty, contact Palram at 1-800-999-9459 or visit us on line at www.PalramAmericas.com.

©2008 Palram Americas. All Rights Reserved.

Installation Overview