

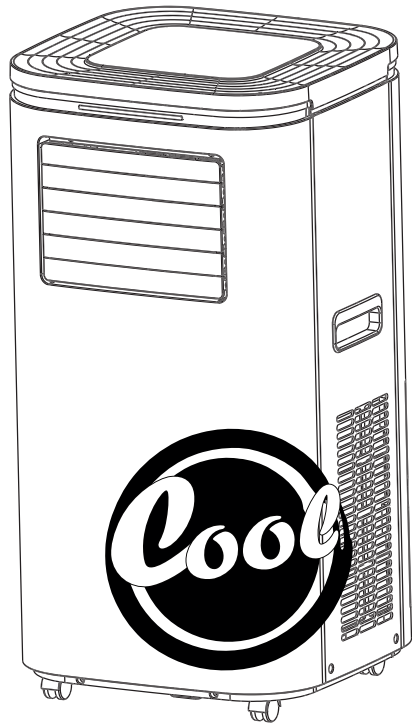

ROLLICOOL[®]

Portable Air Conditioner

COOL 100H-20



USER MANUAL

SAVE THIS MANUAL FOR FUTURE REFERENCE

14,000 BTU
COOLING

COOL100H-20

In order to continue serving our customers and providing the best products, our product information including our user manuals may receive updates from time to time. Please check our website for the latest user manuals and product materials. Ver 4.0 6/01/20



www.rollibot.com

Customer Service: 1-844-585-6295

Dear Rollibot RolliCool Owner,

Welcome to the new age of cool!

The RolliCool 100H-20 is an air conditioner that uses the latest technology to improve your quality of life. We've designed this unit to be fully portable and easy to use in your home. It features multiple modes to keep you comfortable no matter what the weather's like!

The RolliCool 100H-20 is designed for indoor use and can be used in differently sized spaces. Casters make it easy to move the unit from room to room so you can stay comfortable anywhere.

All of the unit's features are available through the RolliCool app. After pairing your unit with your smartphone, you'll be able to stay comfortable however you like!

Thank you for being a part of the Rollibot family!

— The RolliBot Team

Contents

- Section 1. Information & Safety Warnings 5**
 - 1.1 – Introduction 5
 - 1.2 – Safety Warnings 5
 - 1.3 – FCC Information 6
 - 1.4 – Disposal at End-of-Life 6
- Section 2. RolliCool Parts 7**
 - 2.1 – Box Contents 7
 - 2.2 – Components Overview 7
 - 2.3 – Control Panel 8
- Section 3. Setting Up the Unit 10**
- Section 4. Wireless Setup 13**
 - 4.1 App Installation 13
 - 4.2 App Pairing 13
 - 4.3 Amazon Alexa Setup 14
- Section 5. How to Use the RolliCool 14**
 - 5.1 – Timer 14
 - 5.2 – Fan Mode 15
 - 5.3 – Cool Mode 15
 - 5.4 – Dehumidify Mode 15
- Section 6. Maintenance 16**
 - 6.1 – How to Clean the Filters 16
 - 6.2 – How to Drain the Unit 16
- Section 7. Storage 17**
- Section 8. Troubleshooting 18**
- Section 9. Warranty 19**
 - 9.1 – Violation 19
 - 9.2 – Information 19

Section 1. Information & Safety Warnings

1.1 – Introduction

This user manual will guide you through the functions and usage of your RolliCool 100H-20 Portable AC unit. It is important that you follow all instructions and pay attention to all notes that appear throughout this manual. Consult this manual before you attempt to use your RolliCool. If you have questions not answered by this manual or are in need of repair or non-routine service, contact customer service at 1-844-585-6295. Before contacting customer service, please have your purchase information ready as this may be needed during the call. This information may be recorded below.

Date of Purchase: _____

Place of Purchase: _____

1.2 – Safety Warnings

When reading this manual, note these icons:



• Notes with this icon **MUST** be read, understood, and obeyed to prevent injury or damage etc.



• Notes with this icon include relevant information.



Overall Usage

- Do not insert objects into the product.
- The product is not a toy. Do not leave children unsupervised around the product.
- The product is designed for indoor use only.
- Keep the product upright at all times.
- Do not use the product near any of the following places:
 - Near anything flammable
 - Direct sunlight
 - Damp areas
 - Dusty areas
- Do not use wax, thinner, or solvents when cleaning the air conditioner.
- Clean your filters once or more every couple of weeks.
- Do not place any obstacles in front of the any air inlet or outlet.
- Do not pull on the power cords or cables.
- In the event that the product is malfunctioning, shut the power off immediately.
- Switch off the product before cleaning.
- Only use parts you have received from RolliBot® or that have been included in the original packaging.
- Do not use the product for any purpose other than described in this user manual.

Installation Warnings



- Do not install the product in a sloped setting.
- Do not install the product in direct sunlight.
- Do not install the product in places with open flames or flammable gas.
- Do not use extension cords etc. Only plug the product into a grounded wall outlet.

- *Avoid installing the product in damp areas.*
- *Make sure to drain the product with the included drainage pipe.*

1.3 – FCC Information

DECLARATION OF CONFORMITY:

This device complies with Part 15 of the FCC Rules.

Operation is subject to the following two conditions: (1) This device may not cause harmful interference, and (2) this device must accept any interference received, including interference that may cause undesired operation.

FCC RELATED INFORMATION:

This equipment has been tested and found to comply with the limits for a Class B digital device, pursuant to Part 15 of the FCC Rules. These limits are designed to provide reasonable protection against harmful interference in a residential installation. This equipment generates, uses, and can radiate radio frequency energy and, if not installed and used in accordance with the instructions, may cause harmful interference to radio communications. However, there is no guarantee that interference will not occur in a particular installation. If this equipment does cause harmful interference to radio or television reception, which can be determined by turning the equipment off and on, the user is encouraged to try to correct the interference by one or more of the following measures:

- Reorient or relocate the receiving antenna.
- Increase the separation between the equipment and receiver.
- Connect the equipment into an outlet on a circuit different from that to which the receiver is connected.
- Consult the dealer or an experienced radio/TV technician for help.

The manufacturer is not responsible for any radio or TV interference caused by unauthorized modifications to this equipment. Such modifications could void the user's authority to operate the equipment.

1.4 – Disposal at End-of-Life

This product must not be disposed of by incineration, landfilling, or mixing with household trash. Improper disposal of this product may cause serious injury. The refrigerants contained inside the RolliCool present chemical risks to the environment. The recommended disposal for any RolliCool 100H-20 Portable AC unit at its end-of-life is to dispose of the entire unit by contacting your local recycling company. Local regulations and laws pertaining to the recycling and disposal of any RolliCool unit and/or products containing them will vary according to your country, state, and local governments. You must check laws and regulations corresponding to where you live in order to dispose of your RolliCool unit properly. It is the user's responsibility to dispose of their equipment properly in accordance with local regulations and laws.

For additional information about where you should drop off your RolliCool unit, please contact your local or regional waste management office, your household waste disposal service, or your point-of-sale.

Section 2. RolliCool Parts

2.1 – Box Contents

- 1 x RolliCool 100H-20 Portable A/C Unit
- 1 x Drainage Pipe
- 1 x Air Filters (pre-installed)
- 1 x Exhaust Pipe
- 1 x Exhaust Pipe Outer Connector
- 1 x Exhaust Pipe Inner Connector
- 1 x Window Kits
- 2 x Screw Fastener (Screw Base x 2, Screw Head x 2, Washers x 2)

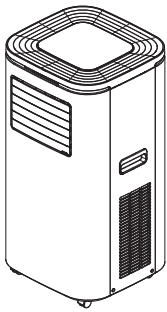
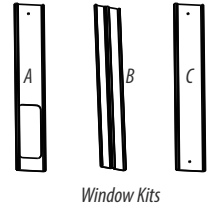

RolliCool 100H-20 Portable A/C Unit

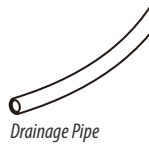

Exhaust Pipe Outer Connector



Exhaust Pipe Inner Connector



Exhaust Pipe

2.2 – Components Overview

- 1 Control Panel
- 2 Louvers
- 3 Front Housing
- 4 Casters

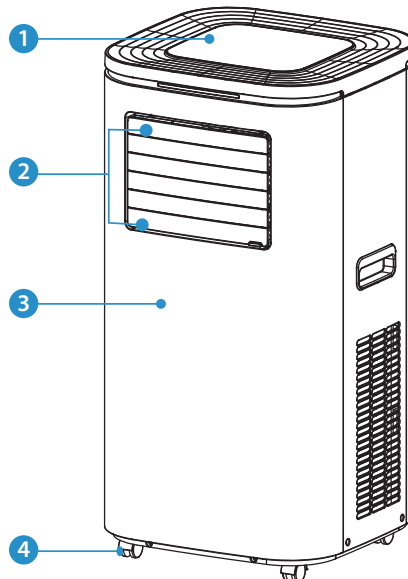

5 Rear Filter

6 Upper Drainage Opening

7 Lower Drainage Opening

8 Side Filter

9 Handle

10 Air Vent

11 Power Cord

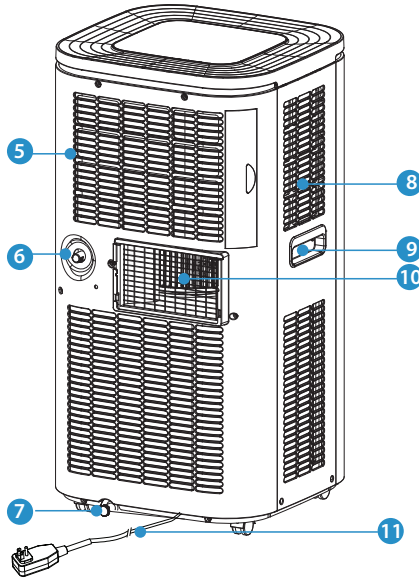

2.3 – Control Panel

The 100H-20 features an LED control panel which turns on when the unit turns on and includes on-screen buttons.

Buttons & Parts

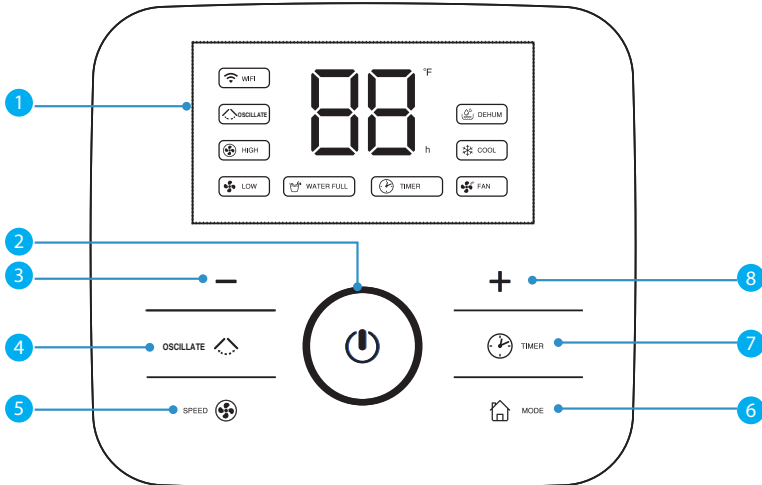

1 **Display:** This section will light up to show temperature and other information.

2 **Power Button:** Press to turn the unit on or off.

3 **Down Button:** Press to lower temperature or adjust timer duration.

4 **OSCILLATE Button:** Press to turn on or off oscillate function.

- 5 **Speed:** Press to cycle through 2 fan speeds (High or Low).
- 6 **Mode Button:** Press to cycle between cool, dehumidify, and fan modes.
- 7 **Timer Button:** Press to turn timer mode on or off.
- 8 **Up Button:** Press to raise temperature or adjust timer duration.

Display Icons

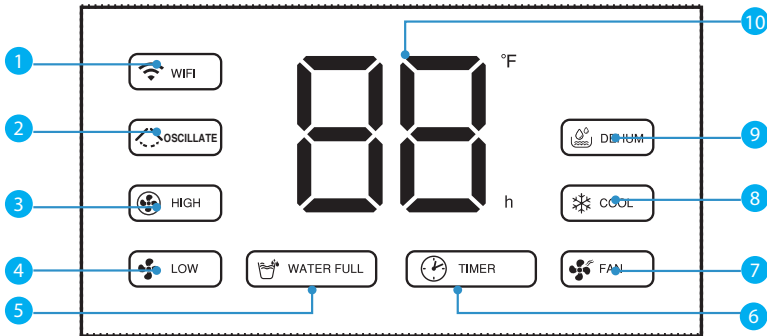

WIFI: This icon will light up when the unit connecting the cell phone via Wi-Fi or Bluetooth.



Oscillate: This icon will light up when the unit is in Oscillate mode.



High: This icon will light up when the speed is high.



Low: This icon will light up when the speed is low.



Water Full: This icon will light up when the unit is full of water.



Timer Mode: This icon will light up when the timer has been programmed.



Fan Mode: This icon will light up when the unit is in fan mode.



Cool Mode: This icon will light up when the unit is in cool mode.



Dehumidify Mode: This icon will light up when the unit is in dehumidify mode.



- Scheduling can be done and/or adjusted via the control panel or the app. See Section 4 for information about the app.
- The control panel displays Fahrenheit temperature as default, and it can't be changed.

Section 3. Setting Up the Unit

- ! Before using the unit, keep it upright for at least two hours.
- Do not use extension cords etc. Only plug the unit into a grounded wall outlet.
- Do not use the unit in bathrooms or other excessively humid environments.
- After installation, keep the unit at least 11.8 in. from the walls at all times.

Window Kit Parts

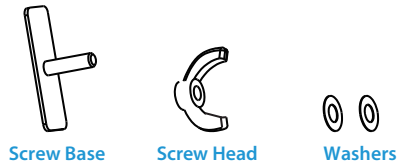
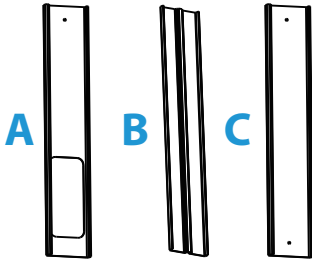

Sections

These sections thread into one another and should be placed within a window gap.

Screw Fastener

These parts are used to secure the sections together and can be loosened or tightened when adjusting the sections according to window height.

Installation

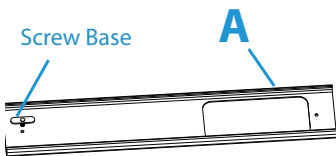

Step 1. Take out one screw base to insert it into one end of section A.

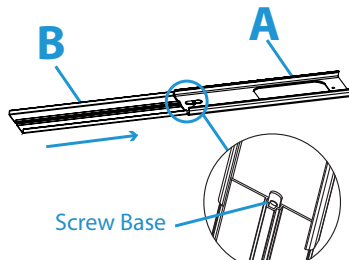

Step 2. Thread section B onto the end of section A and make sure the screw base is also inserted into the screw hole of section B.

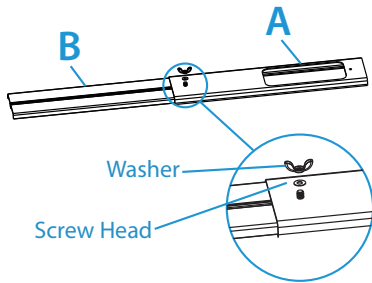

Step 3. Flip over sections A & B to the other side, and place the washer, screw head, then tighten sections A & B together.

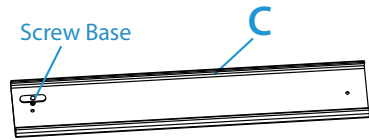

Step 4. Take out the other screw base and insert it into the screw hole of section C.

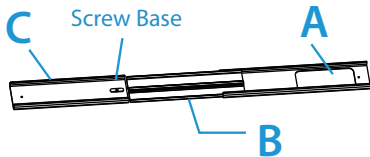

Step 5. Thread section C onto the end of section B. Make sure the screw base is also inserted into the other screw hole of section B.

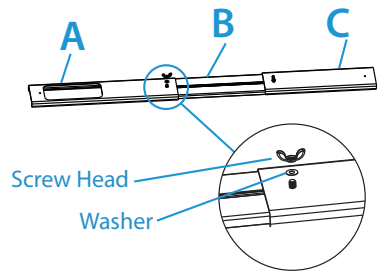

Step 6. Flip over sections A, B & C to the other side, and place the left washer, screw head, then tighten the sections B & C together.

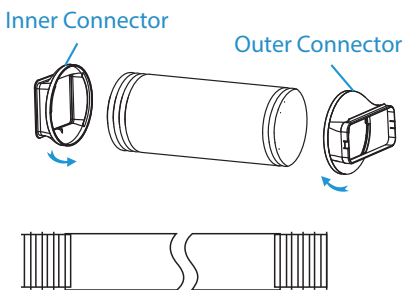

Step 7. Insert the connectors into both sides of the exhaust pipe and rotate them to secure them. When rotating the connectors, both the inner connector and outer connector rotate clockwise to secure them onto the pipe. Unfurl the pipe to the necessary length.

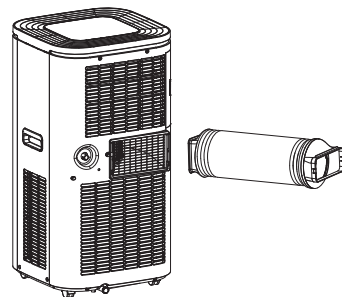

Step 8. Install the exhaust pipe onto the back side of unit. Slide it from right to left to fit the air vent.

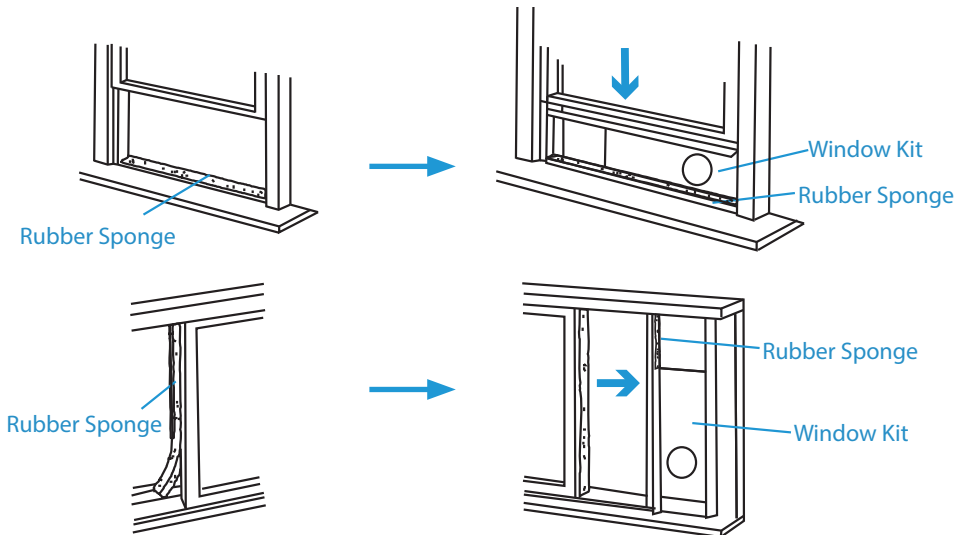

Step 9. Cut the sponge according to the size of the window and stick it on the window frame. Then install the assembled window kit into a gap between the window and the frame, then frame. Push the window nearly closed to secure it. Turn the screw head to tighten or loosen the screw fastener and adjust the sections as needed.

! Using the sponge with the window kit is preferable, as it will create a better window seal; however, it may leave behind residue that could be difficult to clean.

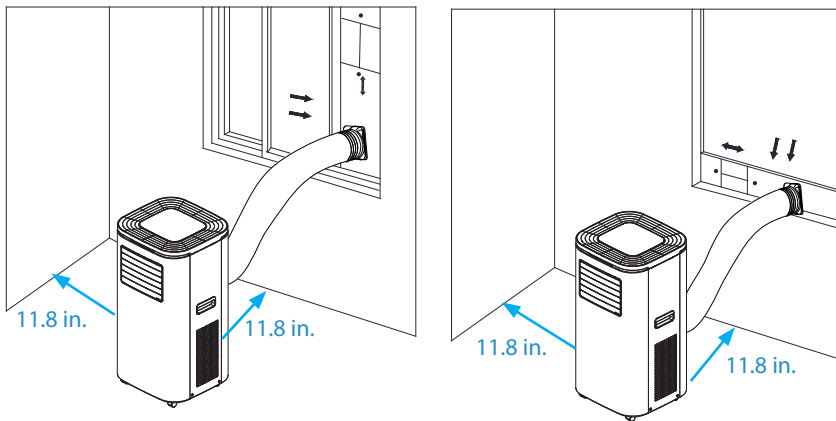

Step 10. Align the outer connector with the window kit's outlet, then affix the exhaust pipe onto the window kit.

- Make sure the exhaust pipe is not bent or kinked as this may inhibit air flow and/or damage the unit.
- Make sure that the machine is placed in a flat position and the air outlet is not blocked
- Make sure the machine is placed at least 11.8 in. (30 cm) away from the wall.

Section 4. Wireless Setup

For your convenience, there is an app for this AC unit. The app is compatible with most Android and iOS smartphones. Additionally, the unit can also be paired with Alexa and other products from the Amazon Echo Family.

 You must have the RolliCool app on your smartphone to use Alexa with the RolliCool.

4.1 App Installation

Step 1. Use your smartphone to search the Play or App Store for the “RolliCool” application.

Step 2. Download and install the app according to your operating system.

4.2 App Pairing

-  Bluetooth® will become enabled and stay enabled as long as the RolliCool is turned on.
- For instructions on how to turn on Bluetooth®, consult materials for your smartphone.
- As with most Bluetooth® devices, it is recommended to keep the connected devices at least 32 ft. within each other. The connection may be terminated or fail to work properly if the connected devices are too far apart.

Step 1. Turn on the AC unit then use your phone to turn on Bluetooth® and open the app.

Step 2. Register for an account and return to the app (fig. 1).

Step 3. After logging in, select the desired device type and tap the  icon.

Step 4. Select the access mode and enter wi-fi and Bluetooth® info as needed (fig. 2). The unit may beep and the “WIFI” light should start blinking; after which, the app should begin pairing.

Step 5. After connecting successfully, the app can be used to set cooling schedules, change cooling modes and more (fig. 3).

 Your device may had a different model name by default. To change the device name, tap “More” in the upper corner then select “Rename device” to enter a new name for your COOL100H-20. **Do not use “AC”, “A/C”, “A-C”, or similar iterations, as this will interfere with some Alexa features.**

 After powered down for an extended time, the RolliCool app may not automatically sync with your RolliCool once you turn the unit back on. Wait a few minutes, then restart the AC unit. Follow the pairing steps to pair your smartphone with the unit again.

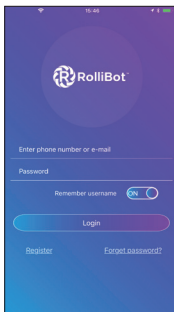

Fig. 1

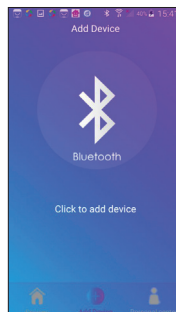

Fig. 2

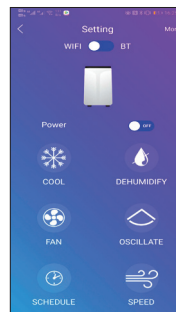

Fig. 3

4.3 Amazon Alexa Setup

Step 1. Search “RolliCool” in the Amazon Alexa app home screen (fig. 4).

Step 2. Select the RolliCool app and tap “ENABLE” (fig. 5).

Step 3. Login your RolliCool account and tap “Link Now”. Follow any additional in-app instructions as needed (fig. 6).

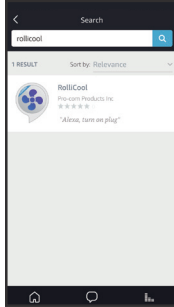

Fig. 4

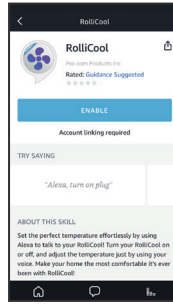

Fig. 5

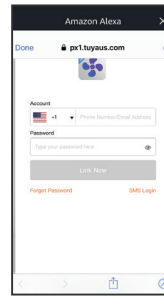



Fig. 6

! *Change the name of your RolliCool 100H-20 before pairing with Alexa; otherwise, Alexa won't be able to identify the default name (RolliCool-smart-12517). Do not use “AC”, “A/C”, “A-C”, or similar iterations, as this will interfere with some Alexa features. List of Alexa commands, Most features can be used by pressing the buttons on the unit's control panel, through Alexa voice commands, or via the RolliCool app.*

1. “Turn on <device name>”: Powers on the RolliCool 100H-20.
2. “Turn off <device name>”: Powers off the RolliCool 100H-20.
3. “Set temperature to <degree>”: Sets RolliCool temperature to specified number.
4. “Turn on AC”: Turns on COOL mode.
5. “Turn off AC”: Switches to FAN mode.

-  • Make sure Amazon Alexa app and RolliCool are connected to the same wi-fi; otherwise, Alexa may not be able to discover your AC unit.
- Make sure you're connecting to a stable wi-fi network. If your wi-fi is unstable, Alexa may disconnect and/or work correctly with your RolliCool.
- You must have the RolliCool app on your smartphone to use Alexa with the RolliCool.

Section 5. How to Use the RolliCool

The COOL100H-20 features a number of ways to keep comfortable. Most features can be used by pressing the buttons on the unit's control panel, the remote, or via the app.

-  • In most cases, the app can be used as a substitute.
- It's recommended to attach the hose to the upper opening when using cool or dehumidify modes. To keep the COOL100H-20 from filling up with water too quickly when certain modes are used, it may be best to attach the drainage hose. See Section 6.2 for information.

5.1 – Timer

With this mode, the unit will automatically turn on or off and regulate temperature according to the selected times.



- Turning on the timer mode when the unit is OFF will set the number of hours before the unit will turn on (see below).
- Turning on the timer mode when the unit is ON will set the number of hours the unit will turn off (see below).
- After setting the timer, the AC unit will enter timer mode. While in this mode, the unit will operate according to the selected timer duration. Pressing the timer button again will turn timer mode off and cancel any duration setting.

To Set a Turn On Time

1. When the unit is OFF, press the timer button on the control panel.
2. Use the up and down buttons to select the time the AC unit will turn on. For example, selecting "03" will prompt the unit to turn on in 3 hours.
3. After the selection is complete, the display's Timing light will turn on.



When a schedule is active, the unit will not turn on if the chosen temperature is higher than the indoor temperature.

To Set a Shut off Time

1. When the unit is ON, press the timer button on the control panel.
2. Use the up and down buttons to select the time the AC unit will turn off. For example, selecting "03" will prompt the unit to turn off in 3 hours.
3. After the selection is complete, the display will show the current indoor temperature and the display's TIMER light will turn on.

5.2 – Fan Mode

With this mode, the unit will turn on and begin using the fan to promote air circulation.

1. Press the power button on the control panel.
2. Press the mode button on the control panel until the display's FAN light turns on.
3. Use the speed button to switch between fan speeds.

5.3 – Cool Mode

With this mode, the unit will turn on and regulate temperature as selected.

1. Press the power button on the control panel.
2. Press the mode button on the control panel until the display's COOL light turns on.
3. Use the up and down buttons to set the desired temperature 62~86°F (16~30°C).
4. Use the speed button to switch between fan speeds.



In cool mode, the unit will not turn on if the chosen temperature is higher than the indoor temperature.

5.4 – Dehumidify Mode

With this mode, the unit will turn on and begin removing moisture from the air.

1. Connect the drainage hose to the upper drainage opening. Set a container near the unit to collect the water (if needed). Then place the end of the drainage pipe in the container.
2. Press the power button on the control panel.
3. Press the mode button on the control panel until the display's DEHUM light turns on.



In dehumidify mode, the fan speed is automatically set to low and cannot be adjusted.

Section 6. Maintenance

Proper maintenance will help improve your RolliCool's performance. Periodically, the RolliCool will need its filters cleaned. For optimal performance, the filters should be cleaned at least twice a month.

- ! • If any type of non-routine maintenance is needed, such as any maintenance not described in Section 6 of this manual, please contact customer service or a certified HVAC professional as the unit contains refrigerant.
- Wipe the exterior clean with non-abrasive cloth. If needed, cloth can be dampened with water.
- Do not use harsh chemicals to clean as these may damage the unit.

6.1 – How to Clean the Filters

- ! • Please make sure your AC unit is completely powered off before performing any type of maintenance.
- Do not scrape the air filters as they may sustain damage.
- A hand vacuum may be used to clean the filters.
- Replace the filters after cleaning. Do not use the RolliCool without the filter.
- If water has been used to clean any filter, ensure it is completely dried before reinstalling. Do NOT dry any filters in direct sunlight.

Cleaning the Filters

1. Reach under the notches and remove the side filter first (1), then remove the rear filter (2). Soak both filters in lukewarm water or use a vacuum to clean the filters. Mild detergents may be used.
2. After the filters have completely dried, reinstall the rear filter (2) first, then the side filter (1).

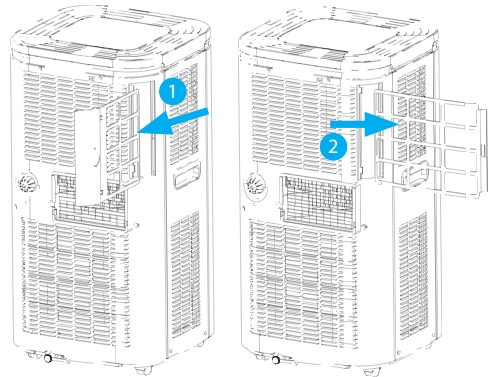

6.2 – How to Drain the Unit

In most cases, the AC unit will not require draining. In the event that draining is necessary, the unit will sound an alarm and the display's "water full" light will turn on to indicate the water reservoir inside is full.

- 🌀 • Please make sure your AC unit is completely powered off before performing any type of maintenance.
- If relocating the unit before draining, move it carefully so as not to spill the water inside the reservoir.
- Make sure the drainage pipe has adequate space underneath for draining. If using the lower drainage opening, ensure there is a suitable area for water runoff. If using the upper drainage opening, fetch a container for water runoff before connecting the pipe.
- Keep the drainage cover and the water plug on at all times when not draining the unit.
- When draining the unit, do not allow the power cord to come in contact with water.
- During drainage, the unit may be tilted slight backwards to promote faster drainage.
- Keep in mind the unit may hold more water than expected. Do not use a small container to drain. Or drain the RolliCool 100H-20 outdoors.

Using the Upper & Lower Drainage Openings

1. Turn off and unplug the unit, then move it to a suitable location for drainage. Set a container near the unit for water runoff if needed, then place the end of the drainage pipe in the container.
2. Remove the cap from the opening and connect the drainage pipe to the unit via the opening.

 *If the drainage pipe is too stiff and/or cannot be attached, try soaking the end in hot water to soften it first.*

3. Allow the water to drain.

 *After draining is complete, it is recommended to turn the unit on and run it in Fan Mode at the lowest speed for at least two hours in order to ensure the Drainage Pipe dries inside.*

4. Detach the pipe and reinstall the cap.

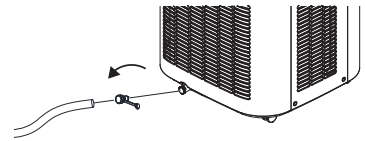
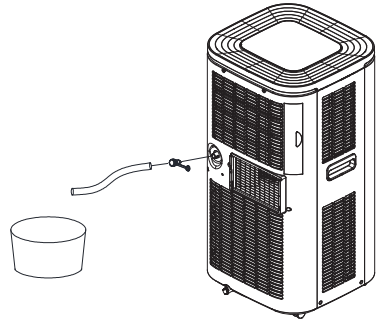

Section 7. Storage

Store your RolliCool 100H-20 in a dry, indoor environment. Properly storing your RolliCool will help improve performance and life expectancy.

Step 1. Turn the AC unit off.

Step 2. Remove the exhaust pipe and window kit as needed for storage with the unit.

Step 3. Drain the unit of any water and ensure all parts are completely dry.

Step 4. Turn the unit on and run it in fan mode at the lowest speed for at least two hours in order to ensure the inner reservoir is dried inside.

Step 5. Turn off the unit and install the power cord's plug into its fixture on the back of the unit.

-  *Always turn the unit off before transporting or storing.*
- Cover the unit to protect it from dust. Do not store in a dusty environment. As with all electronic devices, dust may cause damage over time.*
- Store the unit indoors at a dry and stable temperature. Do not store in an unheated garage, shed, or other locations with extreme temperature fluctuations.*

Section 8. Troubleshooting

Problems	Possible Causes	Solution(s)
The unit does not work.	There is no electricity.	Turn it on after connecting it to a socket with electricity.
	The overflow indicator is on.	Drain the water inside.
	The system is protected	Wait 3 minutes until the temperature is lowered then restart the unit.
The cooling effect is weak.	There is direct sunlight.	Cover any direct sunlight coming through the windows.
	Doors or windows are open; there are a lot of people; or there are other sources of .	Close doors and windows.
	The filter is dirty.	Clean or replace the filter.
Excessive noise	The air inlet or outlet is blocked.	Clear obstructions.
	The unit is not placed on a flat surface.	Place the unit on a flat and stable surface.
Leaking while moving	Water reservoir is full.	Drain the water reservoir before moving
	The drainage plug may be cracked.	Check the drain stop plug for cracks
Display not on	Power plug and socket contact bad or power cord disconnect, no power.	Check the power plug, power cord or socket and connect it again.
There is unusual sound	It is normal to have a slightly stronger vibration sound in the first few minutes before power-up.	Will disappear after few minutes.
Water beads on the surface	In areas of relatively high humidity, air outlet, control panel, and other parts may produce condensation.	It is a normal phenomenon.
	Long-term cooling operation in open spaces with windows open.	Closing windows, doors, etc. may resolve excessive condensation.
	Low fan speed may also lead to increased condensation.	Increase the fan speed.
	The opening angle of the louvers (adjustable vents) is too small.	Increase the angle of the louvers (adjustable vents) or set it to Oscillate mode.

When the RolliCool encounters errors, the display may show certain error codes. Refer to the table below.

Code	Possible Cause	Solution(s)
E1	Humidity sensor failure.	Contact customer service for troubleshooting.
E2	Defrosting temp. sensor failure	Contact customer service for troubleshooting.
E4	Environment temp. sensor failure	Contact customer service for troubleshooting.
E7	Full water alarm	Drain the water reservoir.

If none of the above information resolves your issue, please visit our website at www.rollibot.com or contact customer service at 1-844-585-6295.

Section 9. Warranty

9.1 – Violation

The RolliCool 100H-20 Portable AC Unit cannot be repaired or serviced within its warranty period if any of the following has occurred:



The warranty has expired

Damage occurred during or in relation to non-routine and/or unauthorized disassembly

Failure to provide a valid proof of purchase when requesting service or repair

Damage occurred as a result of natural disaster etc.

Damage occurred due to unexpected factors or man-made reasons (including mis-operation, fluid found in any openings, improper insertion or pulling, hauling, bumping, improper voltage input and others).

9.2 – Information

One-Year Limited Hardware Warranty

Your RolliCool 100H-20 Portable AC Unit (“Product”) includes a One-Year Limited Hardware Warranty (“Warranty”). The Warranty covers product defects in materials and workmanship under normal use. This Warranty is limited to residents of the United States and Canada only and is available only to original purchasers. This Warranty gives you specific legal rights, and you may also have other rights which vary from state to state.

This Warranty starts on the date of your purchase and lasts for one year (the “Warranty Period”). The Warranty Period is not extended if the Product is repaired or replaced. We may change the availability of this limited warranty at our discretion, but any changes will not be retroactive.

Warranty services are provided by Rollibot Warranty Pro (“WP”). If a hardware defect arises and a valid claim is received within the Warranty Period, at its option and to the extent permitted by law, WP will: (1) repair the hardware defect by using new or refurbished parts that are equivalent to new in performance and reliability; or (2) exchange the Product with a product that is new or refurbished which is substantially equivalent to the original product. This Warranty is for one replacement only of like-items and does not cover items out of production if the product is no longer made or stocked. This Warranty is not assignable or transferable. The original purchaser may call WP’s toll-free number at 1-844-585-6295 for a service request.

When a product or part is exchanged, any replacement item becomes your property, and the replaced item becomes WP’s property. This warranty only covers technical hardware defectiveness during the warranty period and under normal use conditions. WP does not warrant uninterrupted or error-free operation of this Product.

This Warranty does not cover any damage due to: (a) transportation; (b) storage; (c) improper use; (d) failure to follow the product instructions or to perform any preventive maintenance; (e) modifications; (f) unauthorized repair; (g) normal wear and tear; or (h) external causes such as accidents, abuse, or other actions or events beyond our reasonable control.

Important: Do not disassemble the Product. Disassembling the Product will void this Warranty. Only WP or a party expressly authorized by WP should perform service on this Product.

DISCLAIMER OF WARRANTY: THE REMEDIES DESCRIBED ABOVE ARE YOUR SOLE AND EXCLUSIVE REMEDIES AND OUR ENTIRE LIABILITY FOR ANY BREACH OF THIS LIMITED WARRANTY. OUR LIABILITY SHALL UNDER NO CIRCUMSTANCES EXCEED THE ACTUAL AMOUNT PAID BY YOU FOR THE DEFECTIVE PRODUCT, NOR SHALL WE UNDER ANY CIRCUMSTANCES BE LIABLE FOR ANY CONSEQUENTIAL, INCIDENTAL, SPECIAL OR PUNITIVE DAMAGES OR LOSSES, WHETHER DIRECT OR INDIRECT.

SOME STATES DO NOT ALLOW THE EXCLUSION OR LIMITATION OF INCIDENTAL OR CONSEQUENTIAL DAMAGES, SO THE ABOVE LIMITATION OR EXCLUSION MAY NOT APPLY TO YOU.

THE DURATION AND REMEDIES OF ALL IMPLIED WARRANTIES, INCLUDING WITHOUT LIMITATION THE WARRANTIES OF MERCHANTABILITY AND FITNESS FOR A PARTICULAR PURPOSE ARE LIMITED TO THE DURATION OF THIS EXPRESS LIMITED WARRANTY



Copyright © 2020. Rollibot, LLC. All Rights Reserved