



High-Pressure Washer

Model No.:BCMh



CAUTION : Do not use this device before reading the instructions.

1. Safety Instructions

- The appliance has been designed solely for private use outdoors and not for commercial use. Keep this appliance away from heat, direct sunlight, moisture and rain, ice and sharp edges.
- Do not allow anybody that has not been trained to use a pressure washer to operate the machine without first reading the instruction manual.
- **WARNING:** High-pressure washers must not be used by children or untrained persons.
- Before starting your machine, carefully check for defects. If you find any, do not start your machine and contact your local distributor.
- In particular, ensure that the electric cable insulation is in perfect condition and free of cracks. If the electric cable is damaged, an approved local service centre must replace it.
- **WARNING:** High pressure jets can be dangerous if they are used incorrectly. The jet

must not be directed towards persons, electrical equipment connected to the mains or the appliance itself.



- **WARNING:** Do not use the appliance close to other people unless they are wearing protective clothing.
- **CAUTION:** Do not direct the jet towards yourself or other persons to clean clothing or shoes.
- Hold the lance firmly in your hands.
- The operator and persons within close proximity to the cleaning area must take necessary measures to protect themselves from dislodged debris when in use.
- Wear protective gloves and clothing during use.
- **WARNING:** The appliance has been designed for use with pressure washer

detergent. Using other cleaning products or chemical products may affect the safety of the appliance.

- **WARNING:** Disconnect the appliance from the power supply before carrying out any maintenance.
- **CAUTION:** To ensure the safety of the appliance, only use spare parts supplied or approved by the manufacturer.
- Do not use the appliance if the power cable or important parts of the appliance are damaged, for example, the safety device, high pressure hose and handgun.
- Do not use the appliance with wet hands. If the appliance is damp or wet, unplug it immediately. Do not place it in water.
- The tyres and valves on the tyres can be damaged by the high pressure jet and could burst.
- Never use the machine in an environment where there is a danger of explosion.
- It is forbidden to clean surfaces containing asbestos at high pressure.
- This high-pressure washer must not be used in temperatures below 0 ° C.
- **CAUTION** - The hoses, accessories and high pressure couplings are important for the safety of the machine. Only use hoses, accessories and couplings recommended by the manufacturer.
- **WARNING:** Inadequate extension cables may be dangerous. Cables and spools must always be completely unwound to avoid letting the cable overheat.
- If an extension cable is used, the plug and socket must be waterproof and conform to the requirements below regarding the length and dimensions of the cable.
 - 1,0 mm² max. 12,5 m
 - 1,5mm²max.20 m
- If the power cable is damaged, it must be replaced by the

manufacturer, their service agent or a qualified professional in order to avoid any danger.

- **WARNING:** This machine is not designed to be used by persons (including children) with reduced physical, sensory or mental capacities or whose lack experience or knowledge.
- **WARNING:** It is advisable that you supervise children to ensure that they do not play with the appliance.
- **CAUTION** – Risk of explosion – do not spray flammable liquids, do not direct the jet towards flammable liquids.
- **WARNING:** Water that has circulated in the anti-backflow system is not considered drinkable.
- **WARNING:** Do not use the appliance if the power cable or important parts of the appliance are damaged, for example, the safety devices, high pressure hoses and handgun.

- **WARNING:** If you have an extension cable, it must be waterproof.
- **WARNING:** When you switch on the machine, a recoil movement is produced due to the force of the water jet. Use two hands to control the lance. Wear safety gloves when using the appliance. Wear suitable protective clothing.
- In case of accidental contact with detergent, wash with water. If the liquid comes into contact with the eyes, also seek medical assistance (the detergent can cause irritations or burns).
- In the event that the appliance breaks down, do not attempt to repair it yourself but contact a professional technician to avoid any danger.

Main power connection

The following must be observed when connecting the high pressure washer to the power supply:

- Connecting the electrical connection should be done by a qualified electrician conforming to 60364-1 CEI
- It is recommended that the electrical supply to this machine should comprise a residual current device which interrupts the current if the leakage current exceeds 30 mA for 30ms.

WARNING:

Always connect the system separator to the water supply and never directly to the device!

**CONNECTING TO THE WATER NETWORK
WARNING**



According  current guidelines, the unit must never be operated without a system separator on the potable water system. Use a EN 12729 type BA system separator. Water that passes through a system separator is classified as non-potable.

Thank you for choosing the
 BCMH High-Pressure Washer

Contents

Chapter	Page
1. Safety Instructions	2
2. Getting Started	7
3. Operating your pressure washer	7
4. End of operation instructions	9
5. Environmental protection	9
6. Maintenance, cleaning and repairing.	9
7. Breakdown service	11
8. WEEE - Waste of Electric and Electronic Equipment	12

Technical data

Motor	Brush
Max. pressure	2300PSI
Max flow	1.75GPM
Current	14.50A
Voltage	120V- /60Hz
Water temperature	40°C

The Circuitry

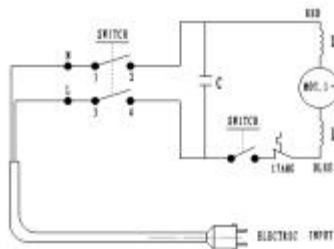

Contents

1. Pressure gun
2. Pressure hose
3. Inlet connector
4. Switch
5. Machine body
6. Cable
7. Plug
8. Inlet water hose
9. Water tap
10. Build-in Detergent bottle
11. Water-out connector
12. Wheels

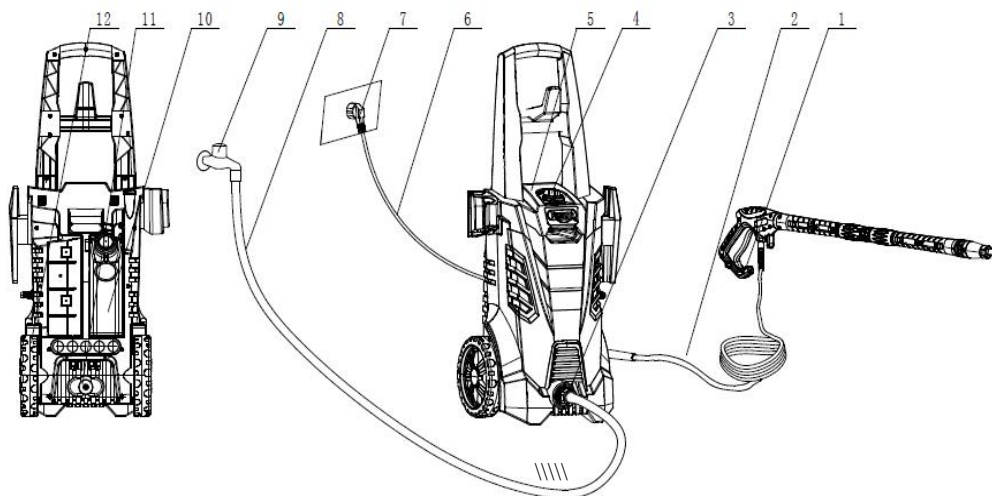

2. First time instructions

This section will explain in details how to make high pressure washer ready for use.

SAFETY DEVICES

- The unloader valve can reduce pressure if it exceeds pre-set values.
- Locking device on trigger gun (see illustration at the beginning of this manual): The trigger gun features a locking device. When the knob is activated, the trigger gun cannot be operated.



THERMAL SENSOR

A thermal sensor protects the motor against overloading. The machine will restart after a few minutes when the thermal sensor has cooled.

3. Operation instructions

3.1 Connection of garden hose

Screw the water inlet coupling (8) tight on to the water inlet Note: The inlet filter (A) must always be fitted in the water inlet pipe to filter out sand, lime stone and other impurities as these will damage the pump valves.

Caution: Failure to fit the filter will invalidate the guarantee.

Connect the garden hose with a standard quick coupling

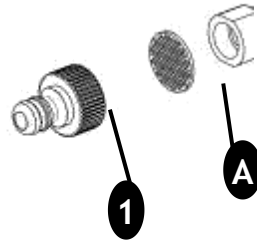

3.2 Mounting of high pressure hose

Attach the high pressure hose to the trigger gun and machine.

Detach the high pressure hose by pressing the pawl (A) or button (B)

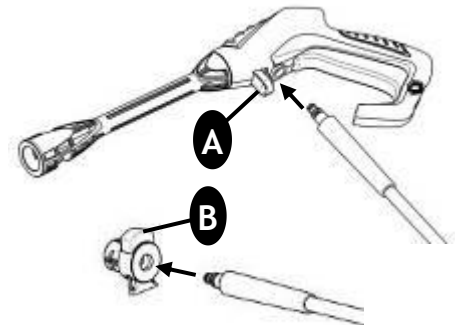

3.3 Mounting of lance and nozzle

Push the lance into the trigger gun
When inserted turn it. Caution: Make sure the lance is properly fixed to the gun
Attach the nozzles. Caution: When attaching the nozzle the button (A) on the nozzle should come out again. Check before activating the trigger that the nozzle is properly fixed.

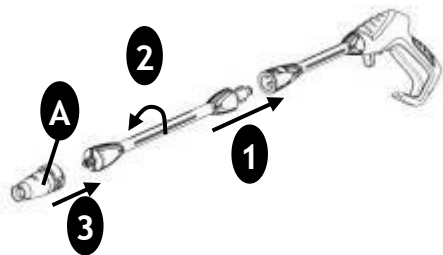

Attention: All accessories nozzle can be installed as above instruction.

3.4 Water connection

Connecting the water supply pipe

Follow your water supplier's instructions .

For connection information, see the data plate/technical specifications

Use a reinforced hose (not supplied) with a standard connection (ext. diameter:

16mm/int. 12mm, maximum length: 25m).

IMPORTANT! Only use water without any impurities. If there is a risk of sand particles in the inlet water (i.e. from your own well), an additional filter should be mounted.

Let the water run through the water hose before connecting it to the machine to prevent sand and dirt from penetrating the machine. Note: Check that the filter is fitted in the water inlet pipe and that it is not clogged up.

Connect the water hose to the water supply by means of the quick connector (inlet water, max. pressure: 10 bar, max. temperature: 40°C).

Turn on the water.

3.5 Start/stop of the machine

The trigger gun (1) and lance is affected by a thrust during operation - therefore always hold it firmly with both hands.

IMPORTANT: Point the nozzle at the ground.

Check that the machine is in upright position. **NOTE:** Do not place the machine in high grass!

Release the trigger lock .

Activate the trigger of the trigger gun (1) and let the water run until all air has escaped from the water hose.

Press the Start/stop switch (4).

Activate the trigger of the trigger gun (1). Always adjust the distance and thus the pressure of the nozzle to the surface, which is to be cleaned.

Do not cover the machine during operation or use it in a room without adequate ventilation!

NOTE: If the machine is left or not used for 5 minutes, it must be switched off on the start/stop switch (4) "O":

Press the start/stop switch (4) "O".

Disconnect the electrical plug (10) from the socket.

Shut off the water supply and activate the trigger of the trigger gun (1) to relieve the machine of pressure.

Lock the trigger gun (1)

When releasing the trigger of the trigger gun (1), the machine automatically stops.

The machine will start again when you re-activate the trigger gun (1)

3.6 Mufti Nozzle

The pressure can for the mufti nozzle be adjusted by tuning it. **WARNING:** Do not do this under operation to avoid that the hand hits the jet.

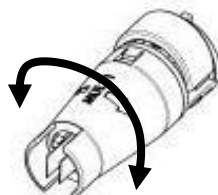

3.7 Use of built-in detergent bottle

Open the lid in the back side of the pressure washer, add detergent to the bottle, replace the nozzle of the spray gun to the detergent nozzle as below, turn the pressure washer on, then spray detergent by pulling the gun trigger.

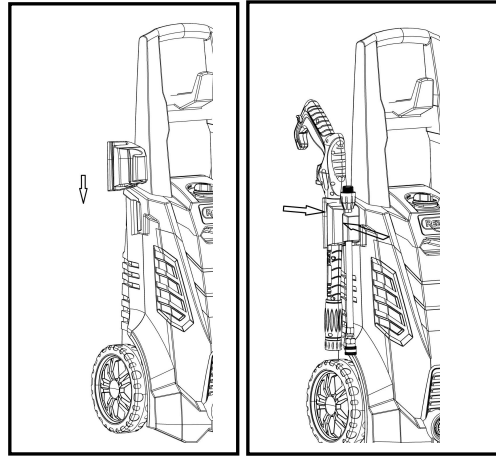

3.8 Mounting of Patio Cleaner

1. Insert the extension lance into to the housing
 2. Fix the extension lance with the two screws to the housing
 3. Insert the rotor arm into the extension lance
 4. Insert the U-pin to fix the rotor arm.
- NOTE: Make sure the rotor arm is properly fixed to the extension lance with the U-pin

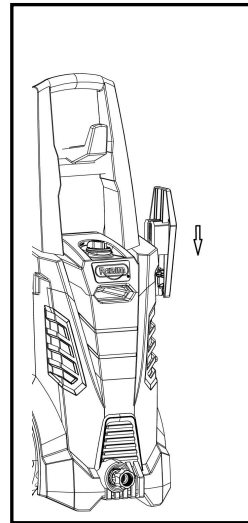
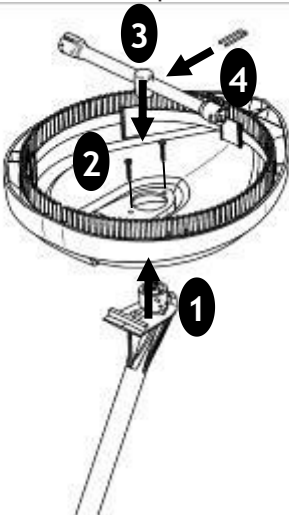

4. After use instructions

The machine should be stored in a frost-free room!

Pump, hose and accessories should always be emptied of water prior to storing as follows:

Stop the machine (press the start/stop switch “O” and detach water hose, high pressure hose and nozzle

Restart the machine and activate the trigger of the trigger gun Let the machine run until no more water runs through the trigger gun Stop the machine, unplug and wind up hose and cable.

Place trigger gun, lance, nozzles and other accessories in the holders of the machine.

The hook can be used for storage of the hose and cord All accessories can be stored in the washer after using.

WARNING: Never start up a frozen machine. Frost damages are not covered by the guarantee!

5. Environmental protection

Old appliances contain valuable materials that can be recycled. Please arrange for the proper recycling of old appliances. Please dispose your old appliances using appropriate collection systems.

6. Maintenance, cleaner and repair

WARNING! Always disconnect the electrical plug from the socket prior to maintenance or cleaning.

To ensure a long and problem free working life, please take the following advice:

Wash out water hose, high pressure hose, spray lance and accessories before mounting.

Clean the connectors of dust and sand.

Rinse the detergent spraying attachment after use.

Clean the nozzles.

Any repair should always be made in an authorized workshop with original spare parts.

6.1 Cleaning of inlet filter

Clean the water inlet filter regularly once a month or more frequently according to use. Carefully loosen the filter with a screwdriver and clean it . Check that it is intact before re-mounting it.

The inlet filter must always be fitted inside the water inlet pipe to filter out sand, limestone and other impurities, as they will damage the pump valves.

CAUTION: Failure to fit the filter will invalidate the warranty

6.2 Cleaning of air vents

The machine should be kept clean so as to let cooling air pass freely through the machine vents.

6.3 Greasing of couplings

To ensure an easy connection and that o-rings do not dry up; the couplings should be greased regularly.

7. Breakdown service

Symptom	Cause	Recommended action
The machine will not start	The machine is not plugged-in	Plug the machine in
	Faulty receptacle	Try another receptacle
	The fuse has blown	Replace the fuse Unplug other appliances
	Faulty extension cable	Try without the extension cable
Fluctuating pressure	The pump is drawing in air	Check that hoses and connections are airtight.
	Valves dirty, worn or sticking	Contact your service centre
	The water supply is not sufficient	Increase water pressure, check for blockages and / or change the large pipe.
	Pump seals worn	Contact your nearest service centre
The machine stops	The fuse has blown	Replace the fuse
	Incorrect mains voltage	Unplug other appliances Check that the mains voltage corresponds to the specifications on the nameplate
	Thermal sensor activated	Leave the machine to cool for 5 min
	Partially blocked jet	Clean the jet with a needle and by spraying water rearwardly through the jet
Fuse blown	Fuse too small	Replace it with a fuse with higher amp consumption than the washer.
	Increase in the amperage	Try without the extension cable
Pulsing machine	Air in inlet hose / pump	Allow machine to run with open trigger until regular working pressure resumes.
	Inadequate supply of water generated	Increase water pressure, check for blockages and / or change the large pipe.
	Partially blocked jet	Clean the jet with a needle and by spraying water rearwardly through the jet
	Water filter blocked	Clean the filter
	Folded pipe	Unfold the pipe
The machine turns on and off by itself	Pump fuse and/or trigger out of order	Contact your nearest service centre
	No water supply	Connect the inflow water.
The machine is on but no water comes out	Water filter blocked	Clean the filter
	Blocked jet	Clean the jet with a needle and by spraying water rearwardly through the jet



WEEE - Waste of Electric and Electronic Equipment



The symbol on the product or on its packing indicates that this product may not be treated as household waste. Instead it shall be handed over to the applicable collection point for the recycling of electrical and electronic equipment. By ensuring this product is disposed of correctly, you will help prevent potential negative consequences for the environment and human health, which could otherwise be caused by inappropriate waste handling of this product. For more detailed information about recycling of this product, please contact your local city office, your household waste disposal service or the shop where you purchased the product.

USA Office:
101 wales avenue, Avon, MA 02322, United States
Service Hotline: 888-899-1688
Email: realminfo@yahoo.com