

# OWNER'S MANUAL

ITEM NO.: WFP38L

READ BEFORE USE!

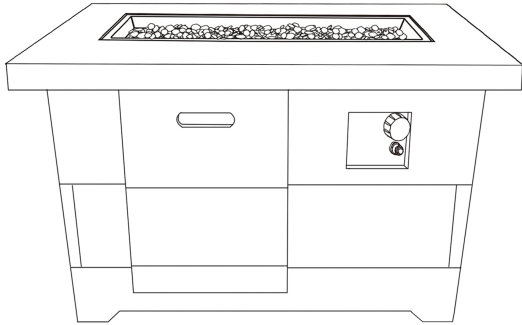

**⚠ WARNING**

**USE PROPANE GAS ONLY!**

- Do not store or use gasoline or other flammable vapors in the vicinity of this or any other appliance.
- Service must be performed by a qualified installer, service agency or the gas supplier.

**⚠ WARNING**

For use with cylinders marked PROPANE only. **DO NOT connect to a remote gas supply.**

If the firebowl is stored indoors, detach and leave propane cylinder outdoors.



Design complies with ANSI Z21.97-2014 • CSA 2.41-(2014) Outdoor Decorative Gas Fireplaces .

**⚠ WARNING**

**For Outdoor Use Only! Use Propane Gas Only !**

**Propane cylinders sold separately.**

**⚠ WARNING**

Improper installation, adjustment, alteration, service or maintenance can cause injury or property damage. Read the owner's manual thoroughly before installing or servicing this equipment. If the information in this manual is not followed exactly, a fire or explosion may result causing property damage, personal injury or loss of life.

**⚠ WARNING**

The propane cylinder must be disconnected when this firebowl is not use.

**⚠ DANGER**

If you smell gas:

1. Shut off gas to the appliance.
2. Extinguish any open flame.
3. If odor continues, keep away from the appliance and immediately call your gas supplier or fire department.

**⚠ WARNING**

This firebowl must be attended at all times!

**⚠ WARNING**

An LP-cylinder not connected for use shall not be stored in the vicinity of this or any other appliance.

**⚠ DANGER**



**CARBON MONOXIDE HAZARD**

This appliance can produce carbon monoxide which has no odor.

Using it in an enclosed space can kill you.

Never use this appliance in an enclosed space such as a camper, tent, car or home.

## SAFETY INFORMATION

Please read and understand this entire manual before attempting to assemble, operate or install the product. Failure to follow the dangers, warnings and cautions contained in this owners manual may result in a fire or explosion causing damage to property, serious bodily injury or death.

### WARNING

- The installation of this product must conform with local codes or, in the absence of local codes, with either the National Fuel Gas Code, ANSI Z223.1/NFPA 54, OR CAN/CGA-B149.1, National Gas and Propane Installation Code.
- FOR OUTDOOR USE ONLY! This appliance shall be used only outdoors in a well-ventilated space and shall not be used in a building, garage, or any other enclosed area.
- USE PROPANE GAS ONLY!
- Use only with a propane gas tank (sold separately). Do not attach to a remote gas supply.
- Propane gas is not natural gas. Only use propane gas for this firebowl.
- The conversion or attempted use of natural gas in a propane unit or propane gas in a natural gas unit is dangerous and not recommended. Doing so will void your warranty.
- Never use charcoal or any other solid fuel in the firebowl.
- During ignition procedure, you should never get your face close to the burner as an unnoticed flame may light up and cause injury.
- LP GAS WARNING: Do not exceed 1/4 in. depth of lava rocks directly above burner holes. Applying too much media may result in unburned gas pooling in firebowl. Ventilation is required to allow fresh air into enclosure and for any residual gas to escape.
- If you see, smell or hear the hiss of escaping gas from the propane gas tank: 1. Disconnect propane gas tank. 2. Do not attempt to correct the problem yourself. 3. Get to your gas supplier and/or the fire department for help.
- Do not operate the firebowl if there is a gas leak present.
- Never use a flame to check for gas leaks.
- The max. inlet supply pressure: max. gas supply 11 inch w.c. (2.74kPa).
- The gas pressure regulator provided with the firebowl must be used.
- Use LP propane gas tanks only with these required measurements: 12 in. (diameter) x 18 in. (tall) with 20 lb. capacity maximum.
- Propane tank used must include a collar to protect the propane gas tank valve.
- Never fill the propane gas tank beyond 80% full.
- Propane gas tank supply system must be arranged for vapor withdrawal.
- Do not use a propane gas tank with a damaged valve and any other worn out parts. A dented or rusty propane gas tank may be hazardous and should be checked by your gas supplier prior to use.
- Do not burn any other materials than are supplied with and intended for use in this firebowl.
- Lava rocks could hit somebody's face or eyes during initial start of this unit, so please keep away from the firebowl for the first 20 minutes after it has been ignited.
- Do not operate firebowl unless it is completely assembled and all parts are in place.
- Pay attention when operating the firebowl. It is hot when in use and should never be left unattended. Do not move it while in operation.
- Do not use this firebowl for cooking.
- Do not put any other fireplace cover or anything flammable on, beneath or around the firebowl.
- Users should be alerted to the hazards of high surface temperatures and keep a safe distance to avoid burning or clothing ignition.
- Do not sit on the firebowl. Do not rest feet or hands on the firebowl.
- Never lean over the open firebowl or place hands or fingers on the upper portion of an operational unit.
- Keep any electrical supply cords and the fuel supply hose away from any heated surfaces.
- Combustible materials should never be within 72 inches of the top, 48 inches of the back or sides of the firebowl.
- This firebowl must be attended at all times!
- Should the fire go out while burning, turn the gas valve off. Follow the instructions and wait five minutes before attempting to relight.
- Do not use this firebowl if any part has been under water.
- Do not pour water into firebowl.
- Immediately call a qualified service technician to inspect the appliance and to replace any part of the control system and any gas control which has been under water.
- Do not light or use gas unit if lava rocks are wet. Ensure lava rocks are completely dry before igniting as intense heat could cause the rocks to crack or pop.
- Do not attempt to disconnect the gas regulator or any gas fittings while your firebowl is in operation.
- Do not handle firebowl until it is shut off and completely cooled.
- The propane gas tank must be disconnected when firebowl is not in use.
- Do not store a spare or disconnected propane gas tank under or near this firebowl, or in the vicinity of any other appliance.
- If the firebowl is stored indoors, detach and leave propane gas tank outdoors.
- Remove the battery when not using the firebowl for an extended length of time.
- Clean the battery contacts and also those of the device prior to battery installation.
- Do not enlarge valve orifices or burner ports when cleaning the valve or burner.

- Do not use this firebowl on vehicles or boats. Always operate the appliance on flat ground outdoors.
- Remove the PVC cover from the firebowl before operating the appliance.
- Do not lay the PVC cover over the firebowl until it is turned off and completely cooled down.
- After a period of storage and/or non-use, the propane firebowl should be checked for gas leaks and burner obstructions before use.
- The propane firebowl should never be used by children. Children must be supervised when they are anywhere near the appliance.
- Please keep gas tank a minimum of 5 feet away from firebowl when lit.
- The maximum gas supply pressure is 250psi.
- Clothing or other flammable materials should not be hung from the appliance, or placed on or near the appliance.
- Any guard or other protective device removed for servicing the appliance must be replaced prior to operating the appliance.
- All installation and repair should be done by a qualified service person. This appliance should be inspected annually. More frequent cleaning may be required as necessary. It is imperative that the control compartment, burners and circulating air passageways of the appliance be kept clean.
- Inspect the burner before each use of this firebowl. If there is evidence of damage, the burner must be replaced prior to use of this firebowl.
- Inspect the hose before each use of this firebowl. If the hose shows signs of cracks, abrasion, cuts or damage, do not use this firebowl. Fix the hose as required before using appliance.
- Remove the hose out of pathways where it may be tripped over or subject to accidental damage.
- Children and adults should be alerted to the hazards of high surface temperatures and should stay away to avoid burns or clothing ignition.
- Young children should be carefully supervised when they are in the area of this appliance.
- The LP gas supply tank must be constructed and marked in accordance with the specifications for LP gas tanks of the U.S. Department of Transportation (DOT) or the National Standard of Canada CAN/CSA-B339, LP gas tanks, spheres and tubes for the Transportation of Dangerous Goods; and Commission.
- The LP gas tank must have a listed overfilling prevention device (OPD) and a QCCI or Type I, (CGA810) LP gas tank connection.

Inspect the hose before each use of the appliance. If the hose shows signs of cracks, abrasions, cuts or damage of any kind, do not operate the appliance. Fix or replace the hose as required before using the appliance. Use only replacement parts from the manufacturer.

## **WARNING !**

- ▶ Do not light or use gas unit if lava rocks are wet. Ensure lava rocks are completely dry before igniting as intense heat could cause the rocks to crack.
- ▶ Lava rocks could hit someone's face or eyes during initial start of this unit, so please keep away from the firebowl for the first 20 minutes after it has been ignited.
- ▶ LP GAS WARNING: Do not exceed 1/4" depth of fire glass or small lava rocks directly above burner holes. Applying too many lava rocks/fire glass may result in unburned gas pooling in firebowl. Ventilation is required to allow fresh air into enclosure and any residual gas to escape.
- ▶ This heating item should not be used on plastic composite or artificial wood decks.

## **Warranty and Installation Information:**

We warranty will be voided by and we disclaims any responsibility for the following actions:

- ▶ Modification of the firebowl and/or components including the gas valve assembly.
- ▶ Use of any component part not manufactured approved.
- ▶ Use and installation other than as instructed in this manual.

ITEM	DESCRIPTION	QTY
A	Lava rocks	1 BOX
B	Body	1PC
C	Door	1PC
D	PVC cover	1PC

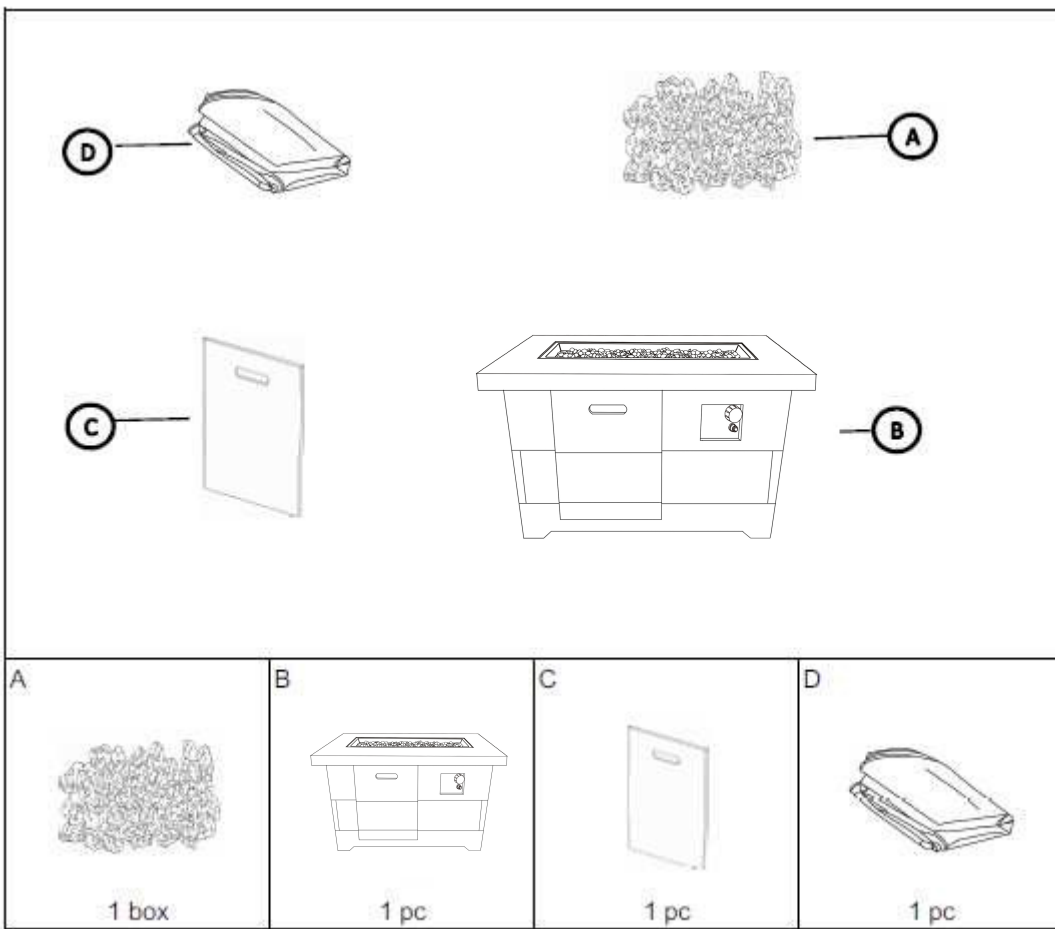

ITEM	SPECIFICATION	QTY	ITEM	SPECIFICATION	QTY
1	Body	1	8	Injector	1
2	Door	1	9	Gas valve	1
3	Burner	1	10	Control knob	1
4	Firebowl pan	1	11	Pulse ignition	1
5	Ignition pin	1	12	Regulator	1
6	Thermocouple	1	13	Ignition Screen	1
7	Corrugated pipe	1	14	Grounding wire	1

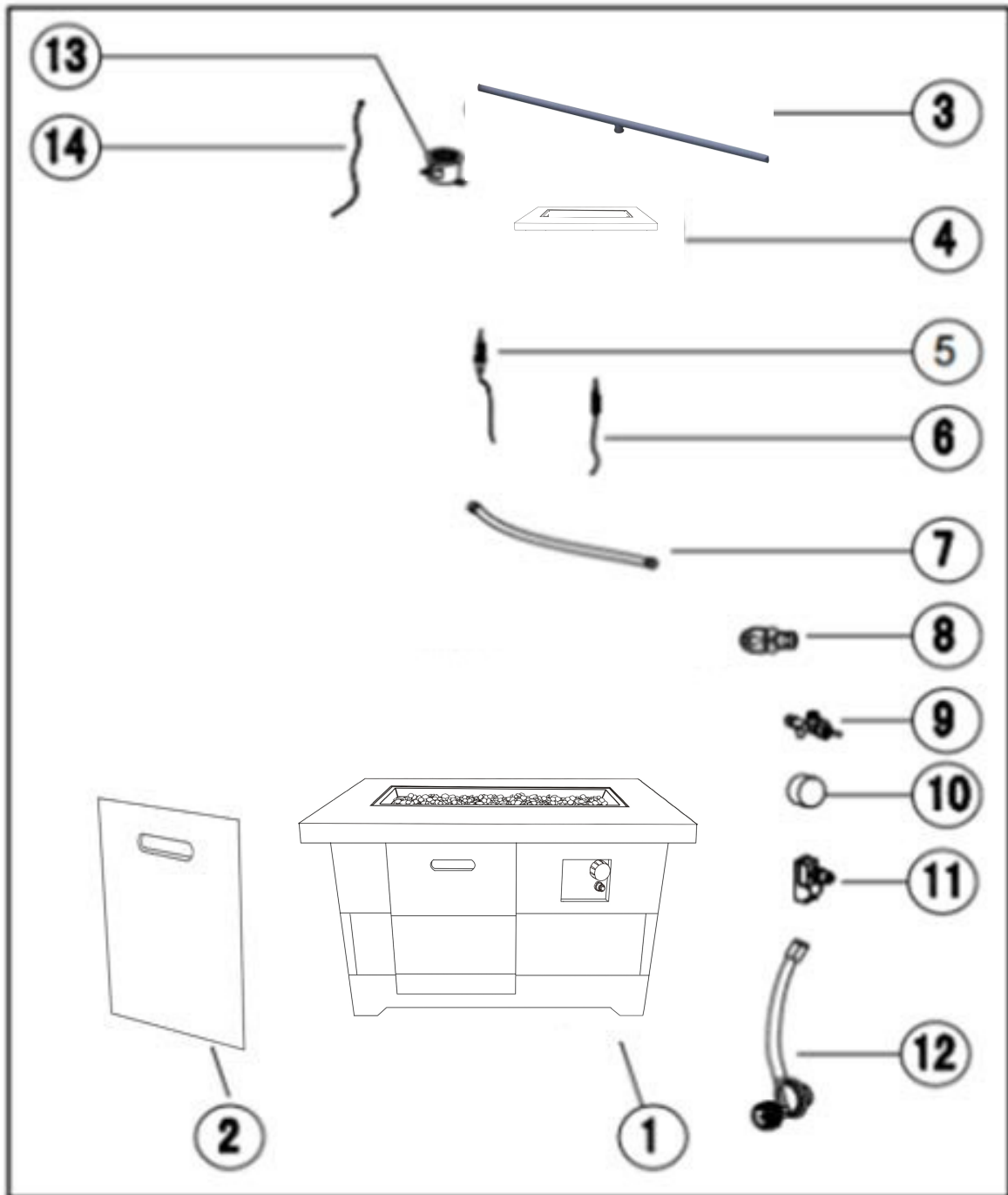

# ASSEMBLY INSTRUCTIONS

\* Please keep owner's manual for future reference.

\*If you have opened the carton and removed all packages, please disregard STEP 1 and 2. See STEP 3 directly.

**STEP 1.** (1) Open the carton and turn it upside down, making sure the 4 pieces of the cartons open up as.  
 (2) Lift off the carton carefully and be wary of the accessories inside falling away.  
 (3) Take all the packing materials away except for the paper honeycomb board rounding the top of the firebowl.

**STEP 2.** (1) Turn the firebowl heads up on a flat ground.  
 (2) Remove all the paper honeycomb board rounding the top of the firebowl.

## STEP 3.

(I) Check each part before using the product. Make sure the gas supply system is turned "OFF" before assembling. See Figure C.

(II) Open the storage door on the firebowl for the gas tank. Take away the box containing lava rock. See Figure C.

(III) Put the gas tank in the metal stand. Make sure the gas tank sits on the metal stand completely. Turn the wing screw on the outer part of metal stand clockwise to secure the gas tank tightly. See Figure F.

(IV) Evenly distribute the lava rocks in the firebowl. See Figure D.

\*\* DO NOT COVER THE IGNITION SCREEN when placing the lava rocks into the firebowl. Always keep Ignition Screen visible.

\*\* Connect the Pressure-Regulating Valve to the gas tank. See Figure G.

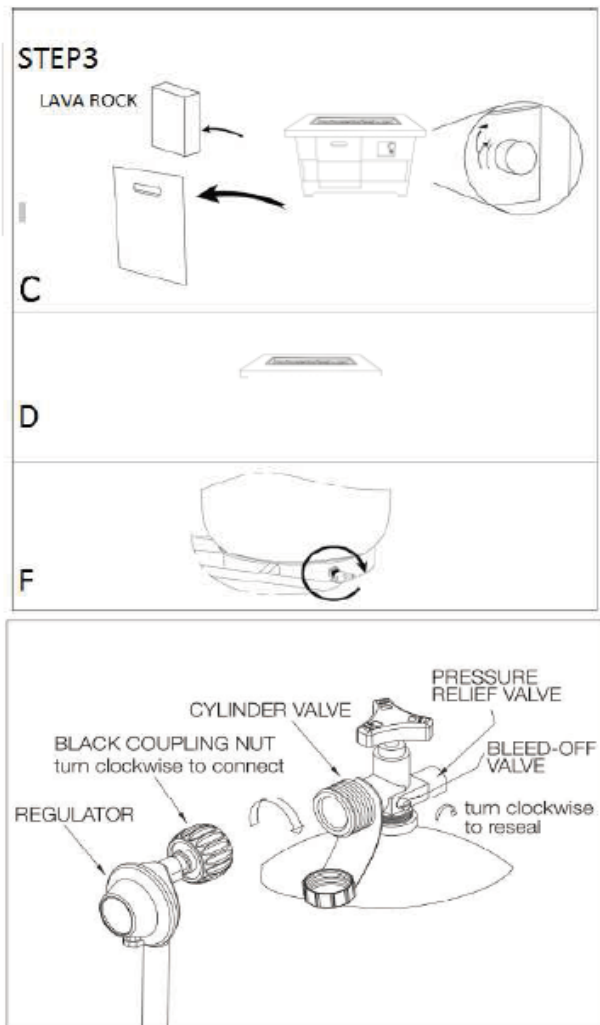

Turn the cylinder valve clockwise to close the gas supply



- 1) on the gas tank.
- 2) Screw Regulator coupling clockwise by hand only. Make sure it is secure.

(V) Remove the Electronic Ignitor Cap (14) on the electronic Ignitor (14) by unscrewing and slide the Battery (B) into the battery slot (14).

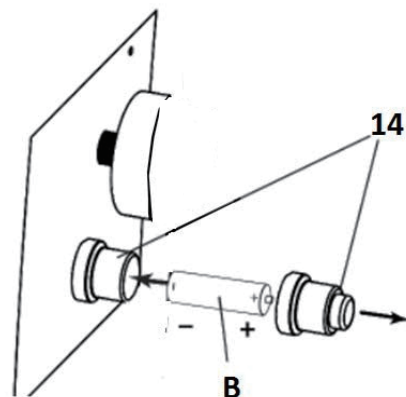
Make sure the positive side of the Battery( B ) faces outwards. Screw the Electronic Ignitor Cap (14) over the battery, tightly.

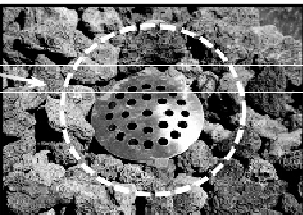

See **WARNING** and Figures:

<p><b>⚠ WARNING</b></p> <p>This screen must be clear and free of obstructions at all times to ensure proper operation.</p>	<p><b>Screen</b> </p> <p><b>DO NOT PLACE LAVA ROCKS ON THE SCREEN. KEEP SCREEN CLEAR.</b></p> 
<p><b>⚠ WARNING</b></p> <p>The burner of the firebowl must be covered by lava rocks or fire glass completely. Otherwise the flame may be extinguished. See the Figure for the <b>CORRECT</b> and <b>INCORRECT</b> ways for reference.</p>	<div style="display: flex; justify-content: space-around;"> <div data-bbox="694 504 901 784">  <p><b>CORRECT</b></p> </div> <div data-bbox="1053 504 1276 784">  <p><b>INCORRECT</b></p> </div> </div>

Perform leak test in a well-ventilated area outside and where no source of spark can occur. Remove battery from igniter. Open tank valve fully (counter-clockwise). Turn the on/off valve at the unit to the “OFF” position to pressurize the hose assembly. Use a soapy water solution to check all the connections for leaks before attempting to light the appliance. **If a leak is found, turn the tank valve off and do not use the appliance until repairs can be made.**

- TIPS:** Before Starting
- Read the instructions thoroughly.
  - Check and make sure that all parts are present.
  - For future reference, save this instruction manual.

**TO LIGHT**

Before each use, inspect the hoses. Replace hose if there are any signs of cutting, wear or abrasion.

- (1) Turn the cylinder valve on the gas tank counter-clockwise to open the gas supply.
- (2) Close the storage door on the firebowl for the gas tank.
- (3) Light the firebowl as below in the following image:

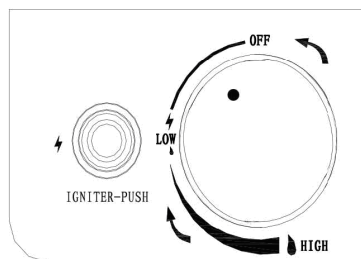

- A. Press and hold the electric igniter. At the same time, push and turn the control knob counter-clockwise to the ‘LOW’ position. Keep pushing the control knob to light the burner.
  - B. After ignition, release the electric igniter. Continue to push and hold the control knob for 45 seconds.
  - C. If ignition does NOT occur within a few seconds, push and turn the control knob clockwise to ‘OFF’. Wait 5 minutes, and then repeat the lighting procedure as above.
- Caution:** \*If the burner does not ignite with the valve open, gas will continue to flow out of the burner and could accidentally ignite with risk of injury.



Observe flame height when lit:  
Flame should be a yellow/blue colour and be from 5cm to 25.5 cm (2 in – 10 in) high.

## TO EXTINGUISH

- Push the control knob and turn clockwise to the 'OFF' position.
- Turn the cylinder valve on the gas tank clockwise to close the gas supply if not in use for a long time. (See figure below.)

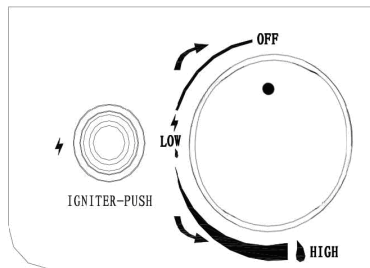

## ROUTINE CARE

- Keep your firebowl free and clear of combustible materials.
- Visually inspect burner for obstructions and keep firebowl free and clear from debris.
- After the burner and lava rocks are completely cooled down, use a soft brush to clean away mild stains and debris.  
Wipe with a soft cloth.

## STUBBORN STAINS

- Stubborn stains, discoloration and possibly rust pitting can occur from exposure to harsh outdoor conditions.
- Be careful not to let any powder or solvent come in contact with painted or plastic components as damage may occur.

## MAINTENANCE

- Store the firebowl in a cool dry place away from direct sunlight and precipitation.
- The propane cylinder must be disconnected and removed from the firebowl before the appliance can be stored indoors.
- Make sure both the gas and the firebowl are turned off before changing battery. Please refer to the battery assembly instructions.
  
- Use manufacturer-approved or supplied replacement parts and accessories only. Otherwise this will void the warranty of this product and may result in a hazardous condition.
- Please contact the manufacturer for information regarding replacement hoses, thermocouples, igniters, lava rocks, etc.
- Protect your firebowl with the PVC cover when not in use. Cover is for UV protection and not suitable for protection from inclement weather.



# Helpful Tips

## If the burner will not light or stay lit, please perform the following checks.

It is possible that the Excess Flow Safety Device has been tripped.

Turn the control knob to off and close the LP Gas tank valve. Disconnect the regulator. Turn the Control Knob to “HIGH”. Wait a minimum of 5 minutes. Turn burner control knob back to “OFF”. Reconnect the regulator and perform a leak check at tank connection. Turn the LP Gas tank valve on slowly, wait 30 seconds and then light the outdoor fire table.

To ensure proper ignition make sure the igniter pin is properly positioned and connected.

- The igniter pin should be pointed straight to the thermocouple.
- The thermocouple should be positioned 5mm away from the burner tube.

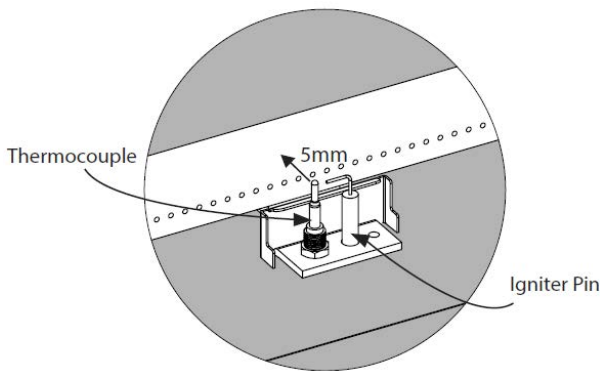

If wires are too close, or tangled, they could short. Make sure they are spaced apart from each other.

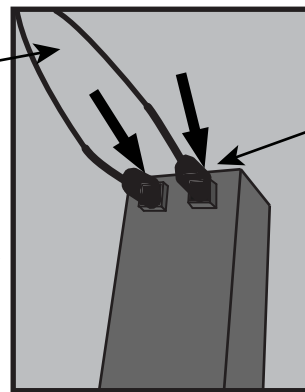

Make sure the wires are fully inserted into the ignitor box.

Make sure that the pilot housing is unobstructed.

Clear any debris on top of the pilot housing and make sure there is no debris between the igniter pin, thermocouple and the burner tube.

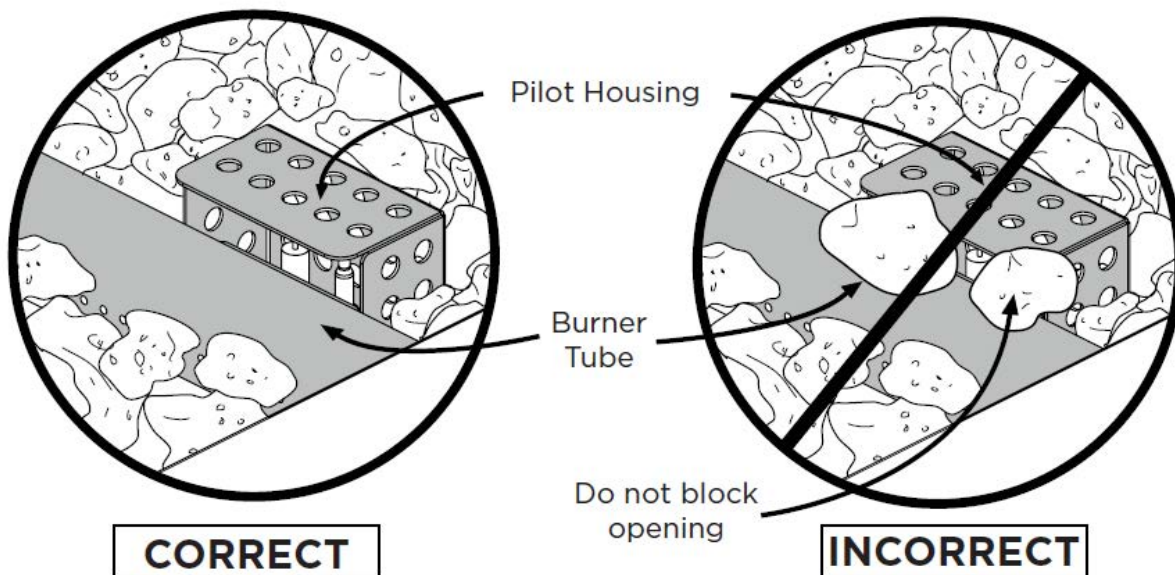

# Troubleshooting

## Problem: Burner will not light using igniter

**Please review the Helpful Tips on page 15 for common fixes to this problem.**

**Possible Cause 1: Electrode and burners are wet.**

-Wipe dry with cloth.

**Possible Cause 2: Igniter battery is dead or backwards.**

-Check that the AAA battery is inserted correctly in the igniter (see page 10) or replace the battery. Make sure the plastic wrap on the battery has been removed.

**Possible Cause 3: Igniter Pin cracked or broken - sparks at crack.**

-PLS contact retailer for technical support.

**Possible Cause 4: Bad Igniter**

-PLS contact retailer for technical support.

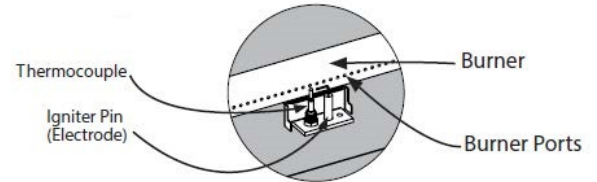

## Problem: Burner will not light with match

**Possible Cause 1: No Gas Flow**

-Check if the LP gas tank is empty. If empty, replace and refill. If the propane tank is not empty, refer to “Problem: Sudden drop in gas flow” on the following page.

**Possible Cause 2: Coupling nut and regulator not fully connected.**

-Turn the coupling nut about one half to three fourths a turn, until you feel a solid stop. Do not use tools, tighten by hand only.

**Possible Cause 3: Obstruction of gas flow.**

- Check for bent or kinked hose.

**Possible Cause 4: Spider webs or insect nest in the venturi.**

- Clean the venturi.

**Possible Cause 5: Burner ports clogged or blocked.**

-Reference “Problem: Irregular flame pattern” on the following page. Clean the burner ports as described there.

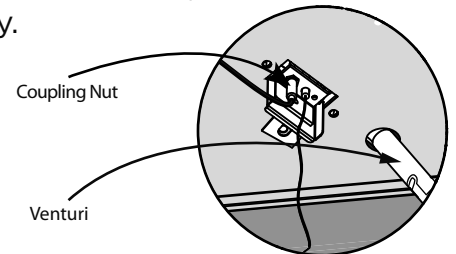

## Problem: The fireplace emits a lot of black smoke when in use

**Possible Cause 1: Hose from gas fireplace is pinched.**

-Make sure the hose is not pinched between the fire table and the source of the gas.

**Possible Cause 2: Flame is being obstructed at burner ports.**

-Make sure that the gas ports on the burner are free of any lava rocks/fire glass so that the flame can flow naturally.

**Possible Cause 3: Mixing chamber of the burn tube is blocked or obstructed.**

-Clear out the mixing chamber located before the Venturi.

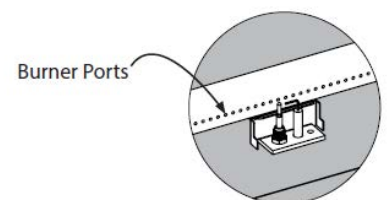

# Troubleshooting

## Problem: Sudden drop in gas flow, or a reduced flame height

### Possible Cause 1: Out of Gas.

-Check for gas in the LP gas tank.

### Possible Cause 2: Excess flow safety device may have been activated.

-Turn control knob to “OFF”, wait 30 seconds and light outdoor fire table. If flames are still too low, reset the excessive flow safety device by turning off the control knob and LP gas tank valve. Disconnect regulator. Turn burner control knob to “HIGH”. Wait at least 5 minutes. Turn burner control knob off. Reconnect regulator and perform a leak check at tank connection. Turn LP gas tank valve on slowly, wait 30 seconds and then light outdoor fire table.

## Problem: Irregular flame pattern, flame does not run the full length of the burner

### Possible Cause: Burner ports are clogged or blocked.

-Clean burner ports. Do this by inserting a paperclip into each of the burner ports to ensure they are not clogged. **WARNING:** Make sure burner is not on, and has had sufficient time to cool before touching it.

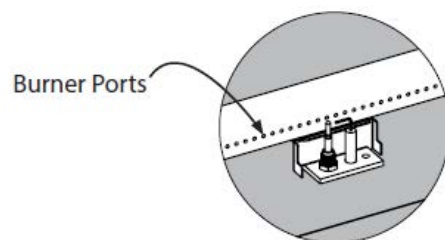

## Problem: Flame blow out

### Possible Cause 1: High or gusting winds.

-Increase flame to “HIGH” setting.

### Possible Cause 2: Low on LP gas.

-Replace or refill LP gas tank.

### Possible Cause 3: Excess flow valve tripped.

-Refer to “Problem: Sudden drop in gas flow”

## Problem: Flame seems to lose heat when burning in cold weather - temperature below 50°F

### Possible Cause 1: Ice has built up on the outside of the LP gas tank because the vaporization process is too low.

-Turn the control knob and the LP gas tank to “OFF”. Replace with a spare LP gas tank and resume burning. Store the spare LP gas tank in a well ventilated area, away from children.

If these trouble shooting steps are unable to resolve the problem,

**PLS contact retailer for technical support.**