

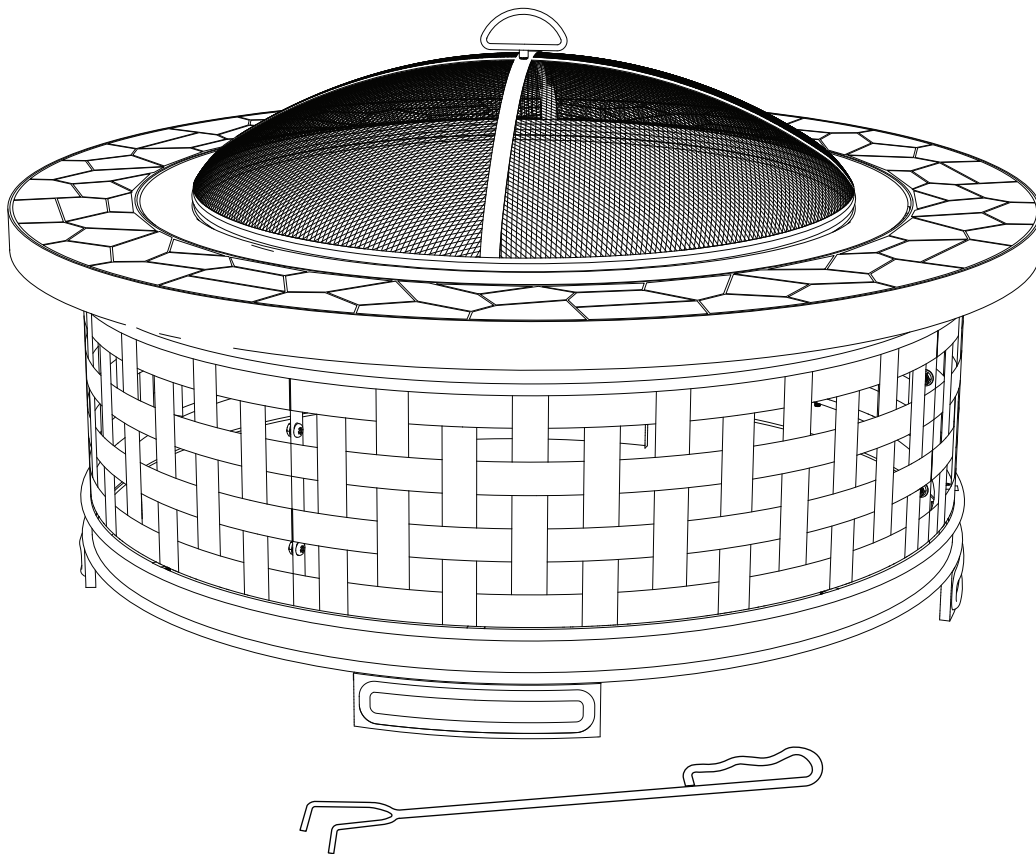

Item #1001 786 387
Model #FTB-51633

USE AND CARE GUIDE

Bay Hill Fire Pit Table



Questions, problems, missing parts? Before returning to the store,
call Hampton Bay Customer Service
8 a.m. - 7 p.m., EST, Monday-Friday
9 a.m. - 6 p.m., EST, Saturday
1-855-HD-HAMPTON

HAMPTONBAY.COM

THANK YOU

We appreciate the trust and confidence you have placed in Hampton Bay through the purchase of this fire pit. We strive to continually create quality products designed to enhance your home. Visit us online to see our full line of products available for your home improvement needs. Thank you for choosing Hampton Bay!

Table of Contents

Table of Contents	2	Hardware Included	3
Safety Information.....	2	Package Contents.....	4
Warranty	3	Assembly.....	5
What is Covered.....	3	Operating Instructions	8
What is Not Covered	3	Maintenance.....	8
Pre-Assembly.....	3	Care and Cleaning	8
Planning Assembly.....	3	Service Parts	9
Tools Required	3		

Safety Information

PLEASE READ AND UNDERSTAND THIS ENTIRE MANUAL BEFORE ATTEMPTING TO ASSEMBLE, OPERATE OR INSTALL THE PRODUCT.



WARNING: FOR OUTDOOR USE ONLY! NEVER LEAVE A FIRE UNATTENDED!



WARNING: DO NOT burn over 5 lbs untreated wood or fire logs in this fire pit.



WARNING: DO NOT USE THE FIRE PIT TO COOK FOOD! The fire pit is not designed for grilling food.



WARNING: DO NOT allow children or pets near fire pit without supervision.



WARNING: DO NOT touch the surface of the fire pit while in use as it may cause burns.



WARNING: NEVER burn in vehicles, tents or indoors. CARBON MONOXIDE HAZARD.



WARNING: Use a poker and/ or heat-resistant gloves to open/close the mesh cover while in use.



WARNING: DO NOT use water to extinguish as this is dangerous and can cause damage to the fire pit.



WARNING: FUELS USED IN WOOD OR CHARCOAL BURNING APPLIANCES, AND THE PRODUCTS OF COMBUSTION OF SUCH FUELS, CAN EXPOSE YOU TO CHEMICALS INCLUDING CARBON BLACK, WHICH IS KNOWN TO THE STATE OF CALIFORNIA TO CAUSE CANCER, AND CARBON MONOXIDE, WHICH IS KNOWN TO THE STATE OF CALIFORNIA TO CAUSE BIRTH DEFECTS OR OTHER REPRODUCTIVE HARM. For more information go to: www.P65Warnings.ca.gov.



CAUTION: Burn only untreated wood or fire logs in this fire pit.



CAUTION: DO NOT use gasoline or kerosene to start the fire in this fire pit.



CAUTION: DO NOT use this unit on a wood deck, long or dry grass and/or leaves, or on combustible surfaces.



CAUTION: DO NOT attempt to move the fire pit while it is hot or in use.



CAUTION: Place the fire pit no closer than 8 ft. from walls or combustibles during use.



CAUTION: Adequate fire extinguishing material should be readily available.



CAUTION: Always ensure that the mesh cover is secured over the fire bowl while in use.



CAUTION: The poker handle may become hot during and after use.

Consumers should check state, provincial, and local codes and regulations regarding the use of the product.

Warranty

1 YEAR LIMITED WARRANTY

WHAT IS COVERED

We warrant the metal frame to be free of manufacturing defects to the original purchaser for one year.

WHAT IS NOT COVERED

It remains the customer's responsibility for freight and packaging charges to and from our service center. This warranty does not cover commercial use, hardware, acts of nature, fire, freezing and abusive use. In addition, purchased parts are not covered under this warranty. We reserve the right to make substitutions with similar merchandise, if the model in question is no longer in production.

Contact the Customer Service Team at 1-855-HD-HAMPTON or visit www.hamptonbay.com.

Pre-Assembly

PLANNING ASSEMBLY

Carefully remove all pieces from the carton and make sure that you have all parts (refer to the hardware and package contents list). If you are missing parts, please contact 1-855-HD-HAMPTON for further assistance.



NOTE: Please read and understand the entire manual before you assemble, operate or install the fire pit.

TOOLS REQUIRED

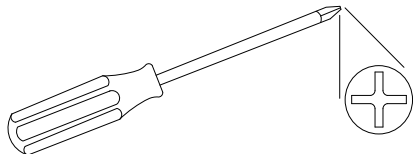

Phillips
screwdriver

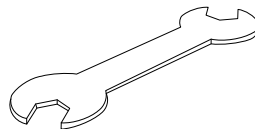

M6 Wrench

HARDWARE INCLUDED



NOTE: Hardware not shown to actual size.

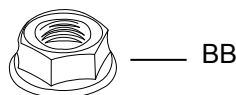
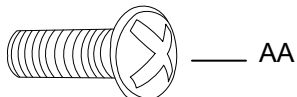

Part	Description	Quantity
AA	M6 x 12 mm Bolt	28
BB	M6 Nut	9

Pre-Assembly (continued)

PACKAGE CONTENTS

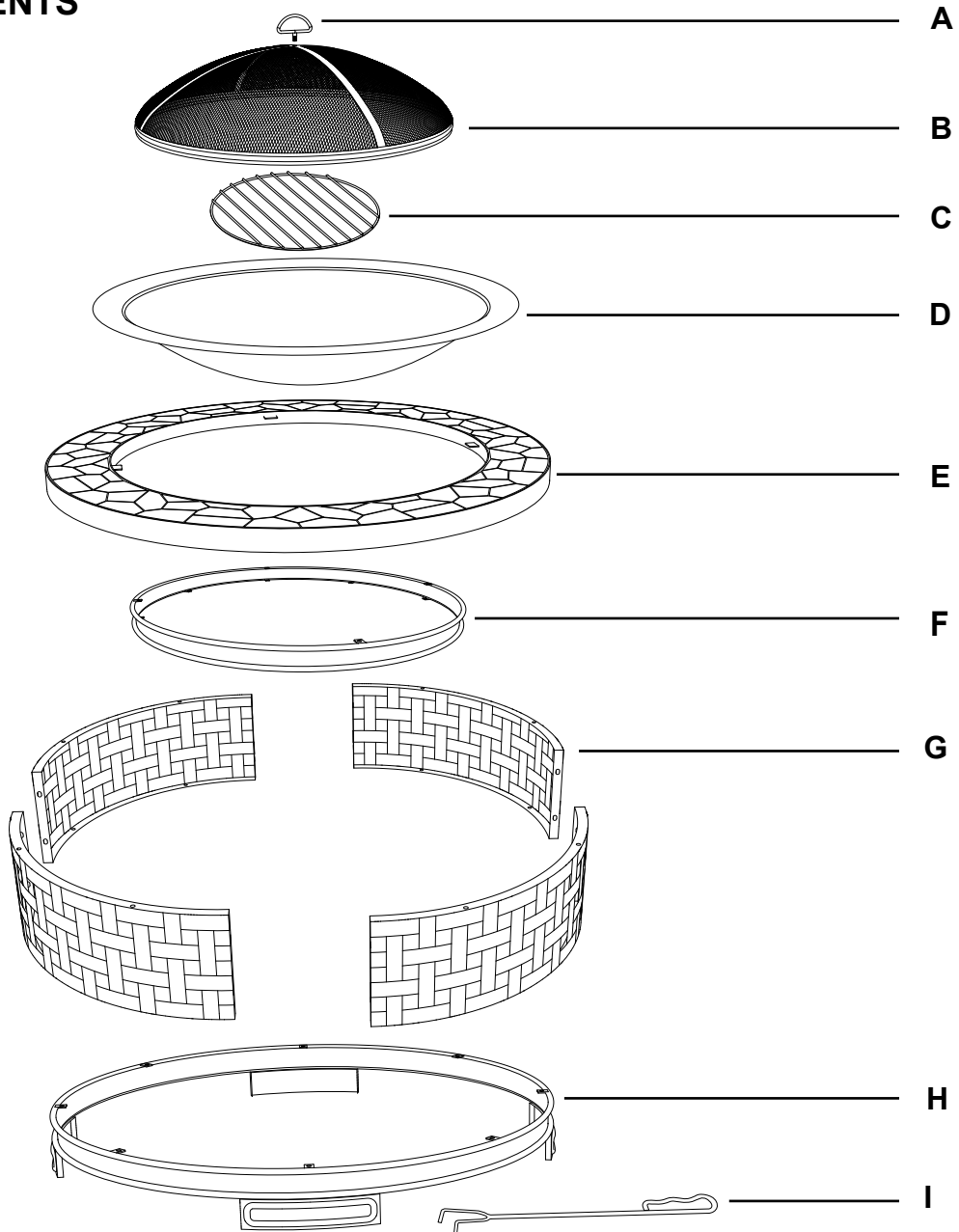

Part	Description	Quantity
A	Handle	1
B	Mesh Cover	1
C	Wood Grate	1
D	Fire Bowl	1
E	Table Top	1
F	Top Ring	1
G	Decoration Frame	4
H	Base	1
I	Poker	1

Assembly

1 Assembling the mesh cover

- Insert the handle (A) into the hole on the top of the mesh cover (B).
- Attach the handle (A) to the mesh cover (B) using a nut (BB). Securely tighten with an M6 wrench (not included).



CAUTION:
Wear gloves during assembly.

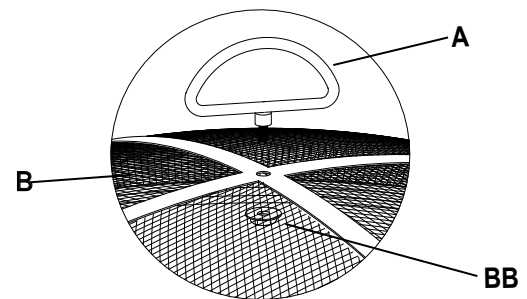
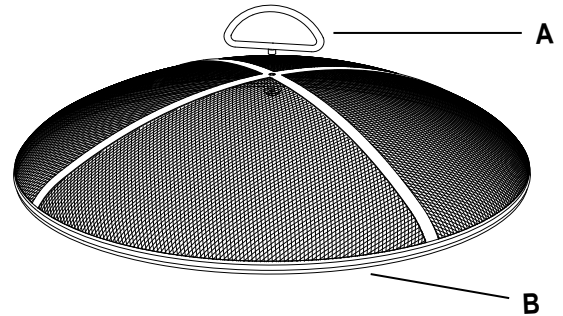

2 Assembling the decoration frames

- Attach the decoration frames (G) to the base (H) using M6 x 12 mm bolts (AA).
- Do not tighten the bolts at this step.

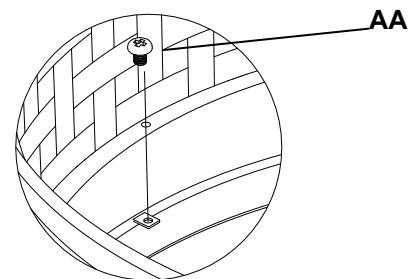
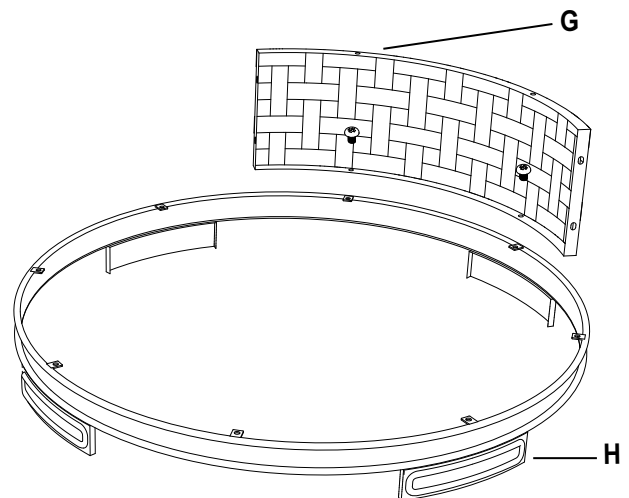

Assembly (continued)

3 Attaching the decoration frame

- Attach the decoration frames (G) using M6 x 12 mm bolts (AA) and M6 nuts (BB).
- Securely tighten each bolt with an M6 wrench (not included).

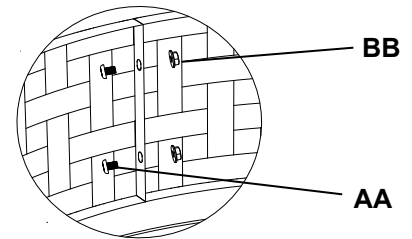
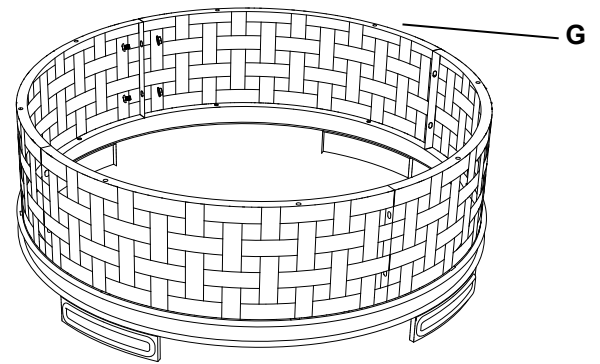

4 Attaching the top ring

- Attach the decoration frames (G) to the top ring (F) using M6 x 12mm bolts (AA).

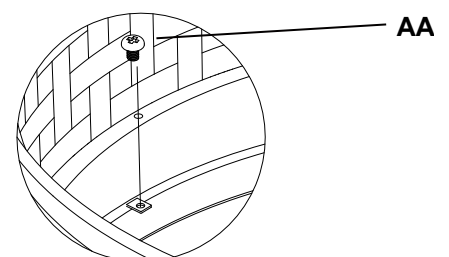
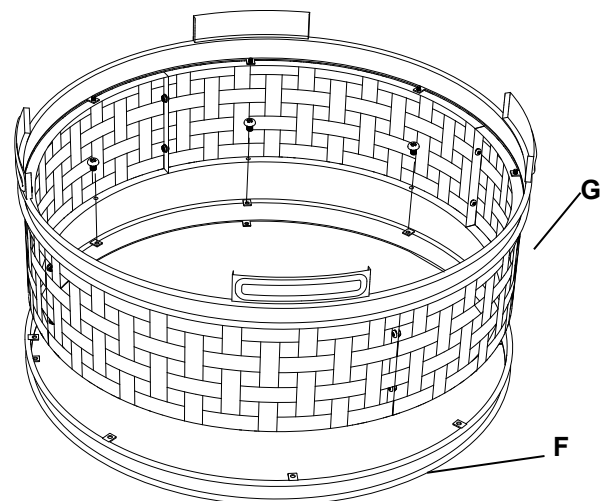

Assembly (continued)

5 Attaching the table top

- Attach the top ring (F) to the table top (E) using M6 x 12 mm bolts (AA).

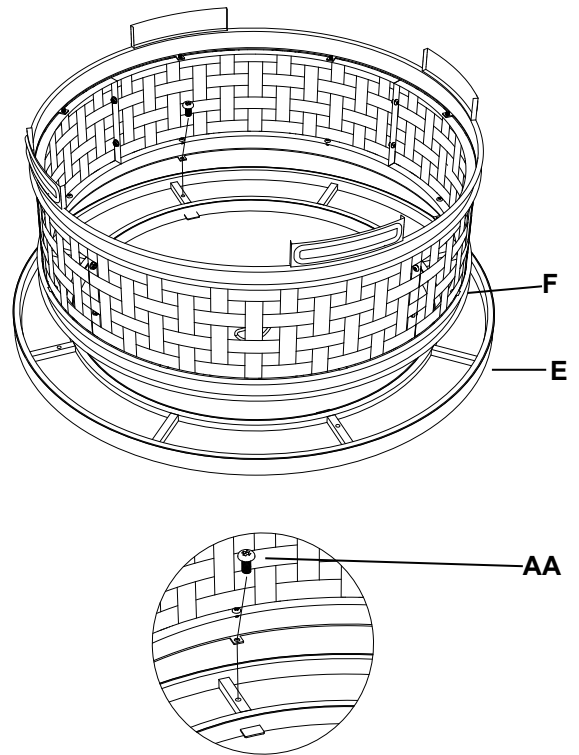

6 Completing the assembly

- Place the poker (I) near the fire pit.

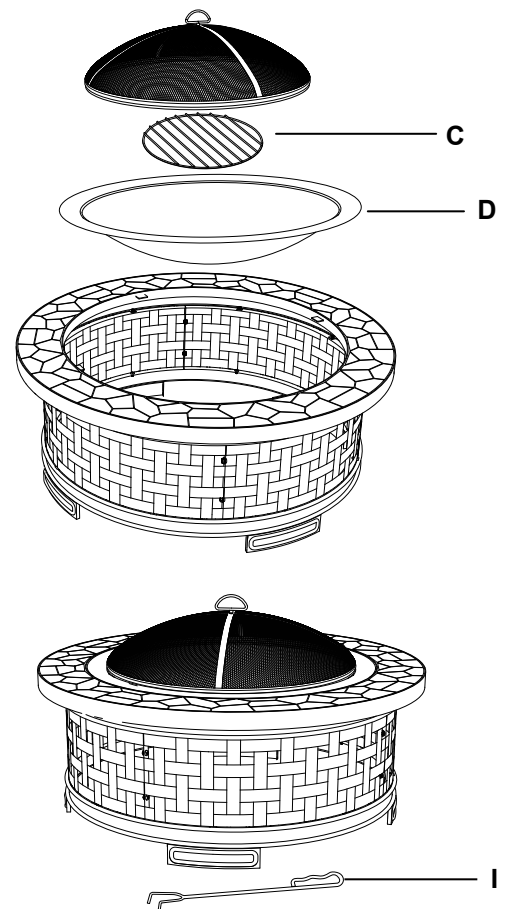

Operating Instructions

Lighting

- Place a layer of dry seasoned hardwood.
- Use a long match or stick lighter to light.
- Use the poker that is provided to operate. Please wear heat-resistant gloves during use.

Extinguishing the Fire

- Allow the fire to burn itself out.
- Except in the event of an emergency, do NOT use water to extinguish a fire as this is dangerous and can cause damage to the outdoor fire pit.

Maintenance

- To extend the life of your fire pit, clean it after each use.
- To protect fire pit finish, use a soft cloth in lieu of bare hands while handling.
- Clean the fire bowl after each use once ashes have cooled.
- Store assembled in a cool, dry location away from children and pets.

Care and Cleaning

- Do not attempt to clean the fire pit until the fire is completely out and cooled completely.
- Use a soft cloth to wipe the fire pit and poker.
- Do not attempt to clean while hot.
- Keep the fire pit covered when cooled and not in use.

Service Parts

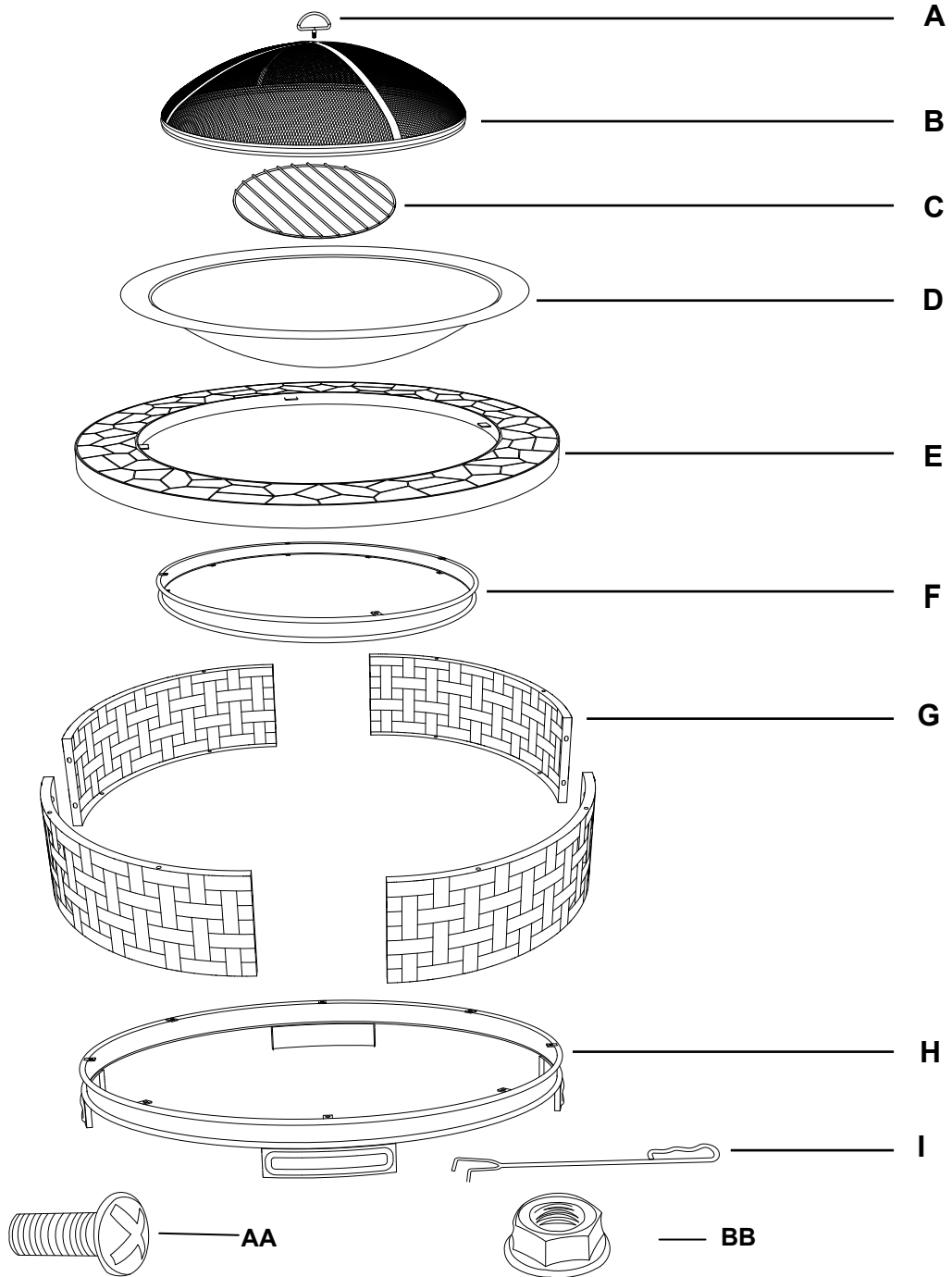

Part	Description	Quantity
A	Handle	1
B	Mesh Cover	1
C	Wood Grate	1
D	Fire Bowl	1
E	Table Top	1
F	Top Ring	1

Part	Description	Quantity
G	Decoration Frame	4
H	Base	1
I	Poker	1
AA	M6 x12 mm Bolt	28
BB	M6 Nut	9



Questions, problems, missing parts? Before returning to the store,
call Hampton Bay Customer Service
8 a.m. - 7 p.m., EST, Monday-Friday
9 a.m. - 6 p.m., EST, Saturday

1-855-HD-HAMPTON

HAMPTONBAY.COM

Retain this manual for future use.