

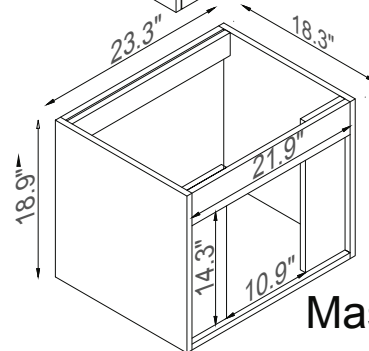

Streamline

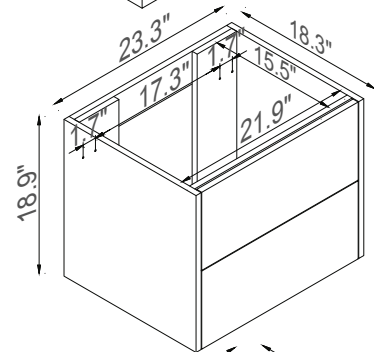
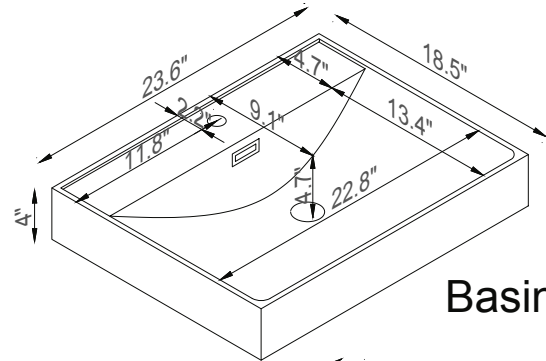

K1500-170-24-51