

# HILTI

**TE 3-M**  
**TE 3-C**

English

en

Français

fr

Español

es



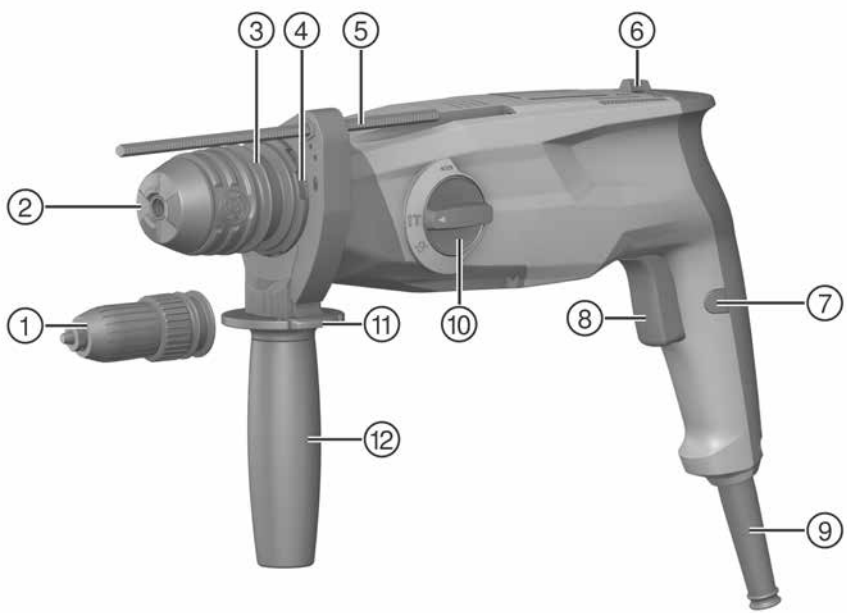

This Product is Certified  
Ce produit est homologué  
Producto homologado por  
Este producto está registrado



2

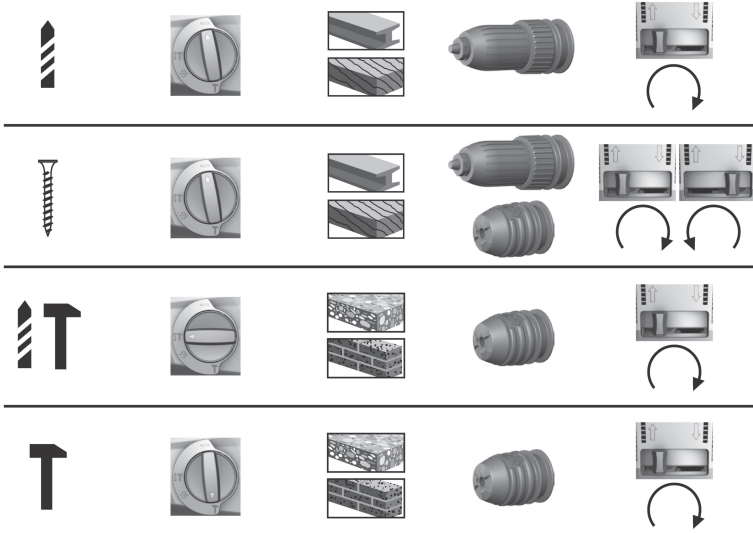

3

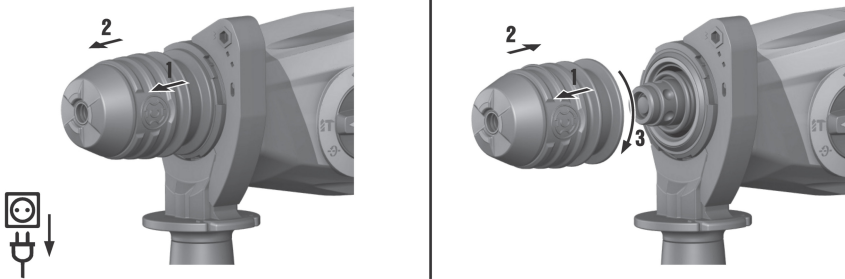

4

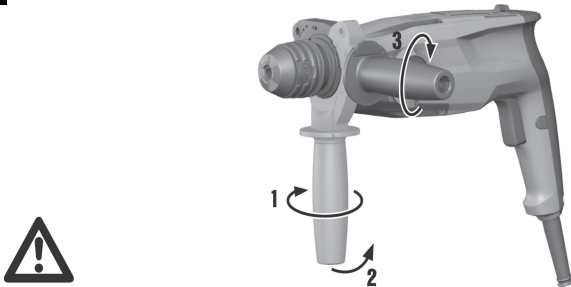

5

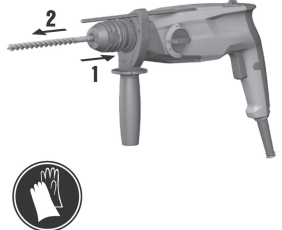
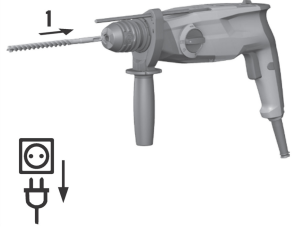
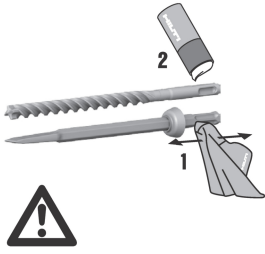

6

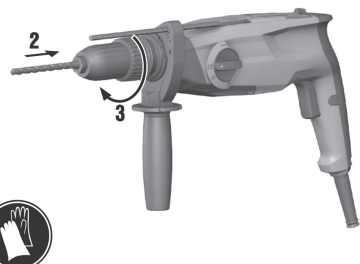
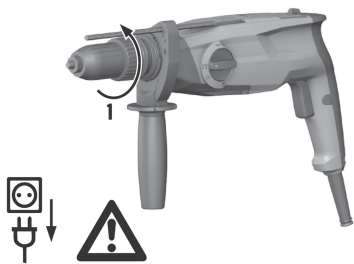

7

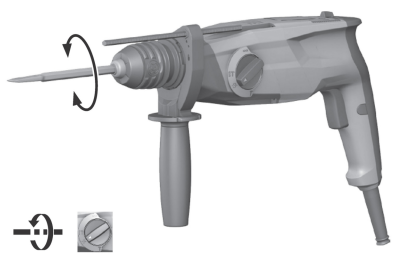
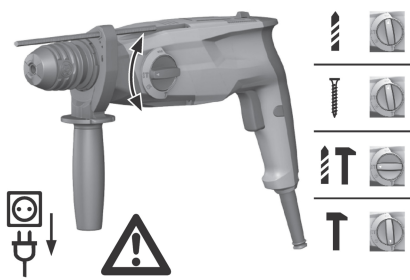

8

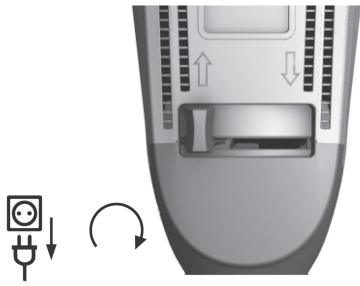

9

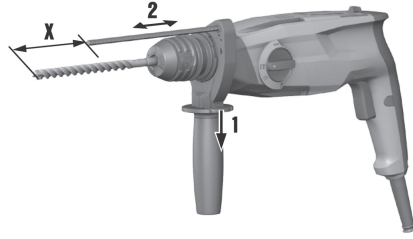

10

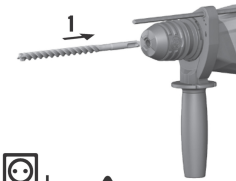

11

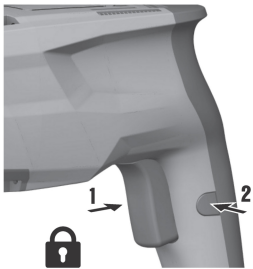

12

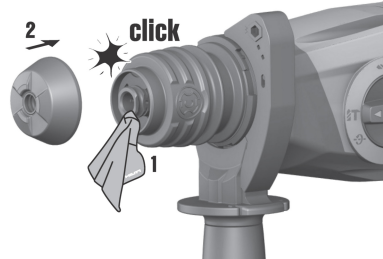
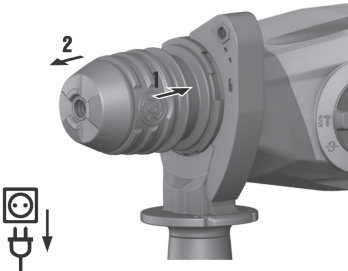

# TE 3-M

# TE 3-C

en	Original operating instructions .....	1
fr	Mode d'emploi original .....	8
es	Manual de instrucciones original .....	15

## 1 Information about the documentation

### 1.1 Conventions











#### 1.1.1 Warning signs

The following warning signs are used:

	General warning
---	-----------------

#### 1.1.2 Symbols

The following symbols are used:

	Read the operating instructions before use.
	Draws attention to an instruction or other useful information.
	Screwdriving
	Drilling without hammering
	Drilling with hammering action (hammer drilling)
	Chiseling
	Chisel positioning
	Forward / reverse
	Locking mechanism open
	Locking mechanism closed
$n_0$	Rated speed under no load
	Protection class II (double-insulated)

#### 1.1.3 Typographic emphasis

The following typographical features are used to emphasize important passages in the technical documentation about the product:

<b>1</b>	These numbers refer to the corresponding illustrations.
----------	---

### 1.2 Operating instructions

- ▶ **It is essential that the operating instructions are read before the tool is operated for the first time.**
- ▶ **Always keep these operating instructions together with the tool.**
- ▶ **Ensure that the operating instructions are with the tool when it is given to other persons.**

Changes and errors excepted.

### 1.3 Product information

The type designation and serial number are printed on the type identification plate.

- ▶ Write down the serial number in the table below. You will be required to state the product details when contacting Hilti Service or your local Hilti organization to enquire about the product.

#### Product information

Rotary hammer	TE 3-M TE 3-C
Generation	01

Serial no.	
------------	--

## 2 Safety

### 2.1 Warnings

#### The purpose of warnings

Warnings alert persons to hazards that occur when handling or using the product.

#### Description of the key words used



##### **DANGER**

Draws attention to imminent danger that will lead to serious personal injury or fatality.



##### **WARNING**

Draws attention to a potentially dangerous situation that could lead to serious personal injury or fatality.



##### **CAUTION**

Draws attention to a potentially dangerous situation that could lead to slight personal injury or damage to the equipment or other property.

### 2.2 Safety instructions

The safety rules given in the following section contain all general safety rules for electric tools which, in accordance with the applicable standards, require to be listed in the operating instructions. Accordingly, some of the rules listed may not be relevant to this electric tool.

#### 2.2.1 General power tool safety warnings

##### WARNING

**Read all safety warnings and all instructions.** Failure to follow the warnings and instructions may result in electric shock, fire and/or serious injury.

**Save all warnings and instructions for future reference.**

The term "power tool" in the warnings refers to your mains-operated (corded) power tool or battery-operated (cordless) power tool.

##### Work area safety

- ▶ **Keep work area clean and well lit.** Cluttered or dark areas invite accidents.
- ▶ **Do not operate power tools in explosive atmospheres, such as in the presence of flammable liquids, gases or dust.** Power tools create sparks which may ignite the dust or fumes.
- ▶ **Keep children and bystanders away while operating a power tool.** Distractions can cause you to lose control.

##### Electrical safety

- ▶ **Power tool plugs must match the outlet. Never modify the plug in any way. Do not use any adapter plugs with earthed (grounded) power tools.** Unmodified plugs and matching outlets will reduce risk of electric shock.
- ▶ **Avoid body contact with earthed or grounded surfaces, such as pipes, radiators, ranges and refrigerators.** There is an increased risk of electric shock if your body is earthed or grounded.
- ▶ **Do not expose power tools to rain or wet conditions.** Water entering a power tool will increase the risk of electric shock.
- ▶ **Do not abuse the cord. Never use the cord for carrying, pulling or unplugging the power tool. Keep cord away from heat, oil, sharp edges or moving parts.** Damaged or entangled cords increase the risk of electric shock.
- ▶ **When operating a power tool outdoors, use an extension cord suitable for outdoor use.** Use of a cord suitable for outdoor use reduces the risk of electric shock.
- ▶ **If operating a power tool in a damp location is unavoidable, use a residual current device (RCD) protected supply.** Use of an RCD reduces the risk of electric shock.

##### Personal safety

- ▶ **Stay alert, watch what you are doing and use common sense when operating a power tool. Do not use a power tool while you are tired or under the influence of drugs, alcohol or medication.** A moment of inattention while operating power tools may result in serious personal injury.
- ▶ **Use personal protective equipment. Always wear eye protection.** Protective equipment such as dust mask, non-skid safety shoes, hard hat, or hearing protection used for appropriate conditions will reduce personal injuries.



- ▶ **Prevent unintentional starting. Ensure the switch is in the off-position before connecting to power source and/or battery pack, picking up or carrying the tool.** Carrying power tools with your finger on the switch or energising power tools that have the switch on invites accidents.
- ▶ **Remove any adjusting key or wrench before turning the power tool on.** A wrench or a key left attached to a rotating part of the power tool may result in personal injury.
- ▶ **Do not overreach. Keep proper footing and balance at all times.** This enables better control of the power tool in unexpected situations.
- ▶ **Dress properly. Do not wear loose clothing or jewellery. Keep your hair, clothing and gloves away from moving parts.** Loose clothes, jewellery or long hair can be caught in moving parts.
- ▶ **If devices are provided for the connection of dust extraction and collection facilities, ensure these are connected and properly used.** Use of dust collection can reduce dust-related hazards.

#### Power tool use and care

- ▶ Do not force the power tool. Use the correct power tool for your application. The correct power tool will do the job better and safer at the rate for which it was designed.
- ▶ **Do not use the power tool if the switch does not turn it on and off.** Any power tool that cannot be controlled with the switch is dangerous and must be repaired.
- ▶ **Disconnect the plug from the power source and/or the battery pack from the power tool before making any adjustments, changing accessories, or storing power tools.** Such preventive safety measures reduce the risk of starting the power tool accidentally.
- ▶ **Store idle power tools out of the reach of children and do not allow persons unfamiliar with the power tool or these instructions to operate the power tool.** Power tools are dangerous in the hands of untrained users.
- ▶ **Maintain power tools. Check for misalignment or binding of moving parts, breakage of parts and any other condition that may affect the power tool's operation. If damaged, have the power tool repaired before use.** Many accidents are caused by poorly maintained power tools.
- ▶ **Keep cutting tools sharp and clean.** Properly maintained cutting tools with sharp cutting edges are less likely to bind and are easier to control.
- ▶ **Use the power tool, accessories and tool bits etc. in accordance with these instructions, taking into account the working conditions and the work to be performed.** Use of the power tool for operations different from those intended could result in a hazardous situation.

#### Service

- ▶ **Have your power tool serviced by a qualified repair person using only identical replacement parts.** This will ensure that the safety of the power tool is maintained.

### 2.2.2 Hammer safety warnings

- ▶ **Wear ear protectors.** Exposure to noise can cause hearing loss.
- ▶ **Use auxiliary handles, if supplied with the tool.** Loss of control can cause personal injury.
- ▶ **Hold power tool by insulated gripping surfaces, when performing an operation where the cutting accessory may contact hidden wiring or its own cord.** Cutting accessory contacting a "live" wire may make exposed metal parts of the power tool "live" and could give the operator an electric shock.

### 2.2.3 Additional safety instructions

#### Personal safety

- ▶ **Modification of the tool is not permitted.**
- ▶ **Keep the grips dry, clean and free from oil and grease.**
- ▶ **Check that the side handle is fitted correctly and tightened securely. Always hold the tool securely with both hands on the grips provided.**
- ▶ **Wear a dust mask if the tool is operated without a dust removal system.**
- ▶ **Improve the blood circulation in your fingers by relaxing your hands and exercising your fingers during breaks between working.**
- ▶ **The tool is not intended for use by debilitated persons who have received no special training.**
- ▶ **Keep the tool out of reach of children.**
- ▶ **Avoid touching rotating parts. Switch the power tool on only after bringing it into position at the workpiece.** Touching rotating parts, especially rotating drill bits or other accessories, may lead to injury.
- ▶ **Always lead the supply cord and extension cord away from the tool to the rear while working.** This helps to avoid tripping over the cord while working.
- ▶ Dust from material such as paint containing lead, some wood species, minerals and metal may be harmful. Contact with or inhalation of the dust may cause allergic reactions and/or respiratory diseases among operators or bystanders. Certain kinds of dust such as oak and beech wood dust

are classified as carcinogenic, especially in conjunction with additives for wood conditioning (chromate, wood preservative). Material containing asbestos may be worked on only by specialists. **Use a dust removal system that is as effective as possible. To achieve a high level of dust collection, use a suitable vacuum cleaner of the type recommended by Hilti for wood dust and/or mineral dust and which is designed for use with this tool. Ensure that the workplace is well ventilated. Observe national regulations applicable to the materials you intend to work with.**

- ▶ **In the event of a power failure or interruption in the electric supply, switch the tool off, unplug the supply cord and release the switch lockbutton (if applicable).** This will prevent accidental restarting when the electric power returns.

#### Electrical safety

- ▶ **Before beginning work, check the working area (e.g. using a metal detector) to ensure that no concealed electric cables or gas and water pipes are present.** External metal parts of the power tool may become live, for example, when an electric cable is damaged accidentally. This presents a serious risk of electric shock.
- ▶ **Check the tool's supply cord at regular intervals and have it replaced by a qualified specialist if found to be damaged. If the tool's supply cord is damaged it must be replaced with a specially-prepared and approved supply cord available from Hilti Customer Service. Check extension cords at regular intervals and replace them if found to be damaged. Do not touch the supply cord or extension cord if it is damaged while working. Disconnect the supply cord plug from the power outlet.** Damaged supply cords or extension cords present a risk of electric shock.

#### Work area

- ▶ **If the work involves breaking right through, take the appropriate safety measures at the opposite side.** Parts breaking away could fall out and / or fall down and injure other persons.

#### Personal safety

- ▶ **Wear protective gloves.** The product can get hot during operation. There is a risk of injury (cutting or burning) if the accessory tool is touched while changing it.

### 3 Description

#### 3.1 Parts of the tool and operating controls 1

①	Three-jaw chuck (TE 3-M)	⑦	Control switch lock
②	SDS quick-release chuck	⑧	Control switch
③	Chuck locking ring	⑨	Supply cord
④	Connection for the dust collection module	⑩	Function selector switch
⑤	Depth gauge	⑪	Depth gauge release button
⑥	Forward / reverse switch	⑫	Side handle

#### 3.2 Intended use

The product described is an electrically powered rotary hammer. It is designed for drilling in concrete, masonry, drywall / gypsum board, plastic, wood, metal and for driving and removing screws. The product can also be used for light chiseling work on masonry and surface finishing on concrete.

**Hilti** products are designed for professional use and may be operated, serviced and maintained only by trained, authorized personnel. This personnel must be informed of any particular hazards that may be encountered. The product described and its ancillary equipment may present hazards when used incorrectly by untrained personnel or when used not as directed.

- ▶ The tool may be operated only when connected to a power supply providing a voltage and frequency in compliance with the information given on its type plate.
- ▶ Observe the national health and safety requirements.
- ▶ To reduce the risk of injury, use only genuine **Hilti** tools and accessories.

#### 3.3 Examples of applications 2

The applications shown are possible.

#### 3.4 Items supplied

Rotary hammer, side handle, depth gauge, operating instructions.

**Note**

For safe, reliable operation, use only genuine Hilti spare parts and accessories. Spare parts, accessories and consumables approved by Hilti for use with this product can be found at your **Hilti Center** or at [www.hilti.com](http://www.hilti.com).

**4 Technical data****Note**









When powered by a generator or transformer, the generator or transformer's power output must be at least twice the rated input power shown on the rating plate of the electric tool. The operating voltage of the transformer or generator must always be within +5% and -15% of the rated voltage of the electric tool.

The information given applies to a rated voltage of 120 V. The data may vary in the event of deviations from the rated voltage and for country-specific versions. Please refer to the electric tool's type identification plate for details of its voltage, frequency, current and input power ratings.

	<b>TE 3-M</b>	<b>TE 3-C</b>
<b>Rated power input</b>	850 W	850 W
<b>Weight</b>	6.8 lb (3.1 kg)	6.6 lb (3.0 kg)
<b>Single impact energy</b>	2.5 J	2.5 J
<b>Drilling diameter range in concrete/masonry (hammer drill bit)</b>	5/32 in ... 1 1/8 in	5/32 in ... 1 1/8 in
<b>Drilling diameter range in concrete/masonry (hammer drill bit)</b>	4 mm ... 28 mm	4 mm ... 28 mm
<b>Drilling diameter range in wood (solid)</b>	1/16 in ... 3/4 in	1/16 in ... 3/4 in
<b>Drilling diameter range in wood (solid)</b>	1.5 mm ... 20 mm	1.5 mm ... 20 mm
<b>Drilling diameter range in metal (solid-head drill bit)</b>	1/16 in ... 1/2 in	1/16 in ... 1/2 in
<b>Drilling diameter range in metal (solid-head drill bit)</b>	1.5 mm ... 13 mm	1.5 mm ... 13 mm

**5 Operation**

TE 3-M	<b>3</b>
<b>Changing the quick-release chuck</b>	
<b>Fitting the side handle</b>	<b>4</b>
<p> <b>CAUTION</b> <b>Risk of injury</b> The depth gauge, if fitted but not used, may hinder the operator.</p> <ul style="list-style-type: none"> <li>▶ Remove the depth gauge from the tool.</li> </ul> <p> <b>CAUTION</b> <b>Risk of injury</b> Loss of control over the rotary hammer.</p> <ul style="list-style-type: none"> <li>▶ Check that the side handle is fitted correctly and tightened securely. Check that the clamping band is engaged in the groove provided on the tool.</li> </ul>	



TE 3-M	<b>5</b>
<b>Fitting/removing the drill bit or other accessory: SDS quick-release chuck</b>	
 <b>Note</b> Use of unsuitable grease may cause damage to the product. <b>Use only the recommended grease supplied by Hilti.</b>	
TE 3-M	<b>6</b>
<b>Fitting/removing the drill bit, chisel or other accessory: Three-jaw chuck</b>	
<b>Drilling without hammering</b> 	<b>7</b>
<b>Screwdriving</b> 	<b>7</b>
<b>Drilling with hammering action (hammer drilling)</b> 	<b>7</b>
<b>Setting the chiseling function</b> 	<b>7</b>
<b>Chisel positioning</b> 	<b>7</b>
 <b>CAUTION</b> <b>Risk of injury</b> Loss of control over the chisel direction. <ul style="list-style-type: none"> <li>Do not operate the tool when the selector switch is set to “Chisel positioning”. Turn the function selector switch until it engages in the “Chiseling”  position.</li> </ul>	
<b>Forward / reverse</b>	<b>8</b>
<b>Adjusting the depth gauge</b>	<b>9</b>
<b>Fitting the dust collection module for overhead work</b>	<b>10</b>
<b>Pressing/locking the control switch</b>	<b>11</b>
<b>Replacing the dust shield</b>	<b>12</b>

## 6 Care of the product

- ▶ **Keep the product, especially its grip surfaces, clean and free from oil and grease. Do not use cleaning agents containing silicone.**
- ▶ Never operate the product when the air vents are blocked. Clean the air vents carefully using a dry brush. Do not allow foreign objects to enter the interior of the product.
- ▶ Clean the outside of the product at regular intervals with a slightly damp cloth. Do not use a spray, steam pressure cleaning equipment or running water for cleaning.

## 7 Troubleshooting

If the trouble you are experiencing is not listed in this table or you are unable to remedy the problem by yourself, please contact **Hilti Service**.

Trouble or fault	Possible cause	Action to be taken
The rotary hammer doesn't start.	Interruption in the electric supply.	▶ Plug in another electric tool or appliance and check whether it works.
No hammering action.	The tool is too cold.	▶ Bring the tip of the drill bit into contact with the working surface, switch the rotary hammer on and allow it to run. If necessary, repeat the procedure until the hammering mechanism begins to operate.
	The function selector switch is set to “Rotary drilling only”  .	▶ Set the function selector switch to the “Hammer drilling” position  .
The rotary hammer doesn't achieve full power.	The gauge (cross section) of the extension cord conductors is inadequate.	▶ Use an extension cord with an adequate conductor cross section.

## 8 Disposal

 Most of the materials from which **Hilti** tools and appliances are manufactured can be recycled. The materials must be correctly separated before they can be recycled. In many countries, your old tools, machines or appliances can be returned to **Hilti** for recycling. Ask **Hilti** Service or your Hilti representative for further information.

## 9 Manufacturer's warranty

- ▶ Please contact your local **Hilti** representative if you have questions about the warranty conditions.



Hilti Corporation

LI-9494 Schaan

Tel.: +423/234 21 11

Fax: +423/234 29 65

[www.hilti.com](http://www.hilti.com)

Hilti = registered trademark of Hilti Corp., Schaan  
Pos. 3 | 20151104



2058841