

Wall Mounting Instructions

Limited warranty for laminate planks on walls: When using this product on walls, we warrant to the original purchaser that the planks will not stain, wear or fade when you follow our installation, cleaning and care instructions.

IMPORTANT: Do not open immediately. You must first acclimatize your planks for 48 hours. For example, if you buy your planks on a Sunday, you'll want to install on Tuesday. Start the acclimation process by laying each box horizontally (flat on their backs) in center of room where they will be installed.

For wall applications, laminate flooring must be at least 8mm thick in order to prevent damage to the locking system caused by brad nailer.

General guidelines before installing:

1. Laminate should be used as a decorative covering over an existing dry and clean wall that is vertical and that meets local building codes. The wall substrate should be primed or painted drywall only. Do not install directly over wallpaper or paneling.
2. Do not use these instructions to mount laminate on ceilings, countertops or as any type of structural material.
3. Laminate is only suitable when used in climate controlled (35-65% RH and 60-85 F) indoor rooms. Maintain these conditions throughout the installation process.
4. You should plan to mix planks from different cartons as you install to achieve the most natural appearance.
5. You should check wall for flatness within 3/16" over 10 feet.
6. Before installing, please check wall for moisture, visible water stains or leaking windows. Do not install laminate over a wall that has had water damage.
7. You should not install your laminate near water sources such as a backsplash over a sink or bathtub.
8. These requirements are not intended to supersede federal, state or local building codes, but as with many other interior finish products, may require modifying existing structural components for successful installation.
9. Owner assumes responsibility for compliance with all building codes.

CAUTION:

Always use safety glasses and a mask. Sawing, sanding or machining wood products can produce wood dust. If that dust gets airborne, it can cause respiratory, eye and skin irritation. Wood dust has been classified as a nasal carcinogen in humans by The International Agency for Research on Cancer (IARC).

Precautionary measure if you bought laminate planks with a pad attached:

If you chose to purchase and install a plank that has an underlayment pad already attached, you should remove the attached pad before using your laminate planks as a wall. This will ensure that the hard backing of each plank is adhered directly to the wall.

Wall Mounting Instructions

Precautionary measures if power tools are used:

Please follow a manufacturer's safety instructions and practices when using power tools. The power tools must be equipped with a dust collector. If you encounter high dust levels, use the appropriate NIOSH-designated dust mask. Avoid dust contact with eyes and skin.

First aid measures in case of irritation:

For 15 minutes you should flush eyes and skin with water. Seek medical attention if irritation persists.

Proposition 65 Warning:

This product contains chemicals known to the state of California to cause cancer and/or reproductive harm. Drilling, sawing, sanding or machining wood products generates wood dust, a substance known to the state of California to cause cancer. Use respiratory protection and other safeguards to avoid inhaling wood dust.

IMPORTANT HEALTH NOTICE FOR MINNESOTA RESIDENTS:

THESE BUILDING MATERIALS EMIT FORMALDEHYDE. EYE, NOSE, AND THROAT IRRITATION, HEADACHE, NAUSEA AND A VARIETY OF ASTHMA-LIKE SYMPTOMS, INCLUDING SHORTNESS OF BREATH, HAVE BEEN REPORTED AS A RESULT OF FORMALDEHYDE EXPOSURE. ELDERLY PERSONS AND YOUNG CHILDREN, AS WELL AS ANYONE WITH A HISTORY OF ASTHMA, ALLERGIES, OR LUNG PROBLEMS, MAY BE AT GREATER RISK. RESEARCH IS CONTINUING ON THE POSSIBLE LONG-TERM EFFECTS OF EXPOSURE TO FORMALDEHYDE. REDUCED VENTILATION MAY ALLOW FORMALDEHYDE AND OTHER CONTAMINANTS TO ACCUMULATE IN THE INDOOR AIR. HIGH INDOOR TEMPERATURES AND HUMIDITY RAISE FORMALDEHYDE LEVELS. WHEN A HOME IS TO BE LOCATED IN AREAS SUBJECT TO EXTREME SUMMER TEMPERATURES, AN AIR-CONDITIONING SYSTEM CAN BE USED TO CONTROL INDOOR TEMPERATURE LEVELS. OTHER MEANS OF CONTROLLED MECHANICAL VENTILATION CAN BE USED TO REDUCE LEVELS OF FORMALDEHYDE AND OTHER INDOOR AIR CONTAMINANTS. IF YOU HAVE ANY QUESTIONS REGARDING THE HEALTH EFFECTS OF FORMALDEHYDE, CONSULT YOUR DOCTOR OR LOCAL HEALTH DEPARTMENT.

Tools you'll need to install your new laminate floor:

- Laminate flooring
- Tape measure
- Caulk gun
- Premium urethane construction adhesive
- Stud finder
- Chalk line
- Air compressor
- Air hose
- Brad nailer
- Miter saw, table saw, jig saw
- Drill
- Spacers

Wall Mounting Instructions

Installing your new laminate floor over various surfaces:

Our laminate product can be installed over the following wall substrates: drywall, painted drywall, plywood, OSB, cement board. All substrates must be sound, clean, dry, smooth and flat. Do not install over greasy/oily surfaces, loose paint or surfaces with extraneous debris.

Buying your planks:

Measure the length and width of the wall area to determine the total square footage area. Order that amount of flooring plus an additional 10% for incorrect cuts.

Arranging your planks:

For standard installations of laminate on walls, the product can be installed horizontally, diagonally and as a wainscoting. For best results...

- Layout the planks on the floor prior to installing on the wall.
- Inspect each plank for damage before installing. Do not install damaged planks.
- Identify the tongue and groove sides of the plank.
- Identify the type of locking system on the short side of your plank by referring to the pictures below. You will either have a Plastic Clip or a Standard locking system.
- Planks can be cut prior to installing on the wall. To maintain a random visual, keep end joints of adjacent rows at least 8" apart.

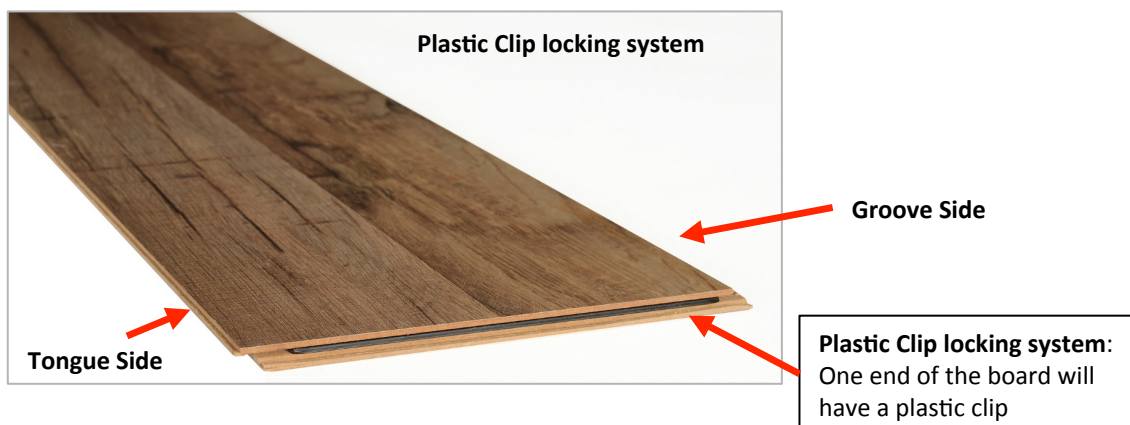
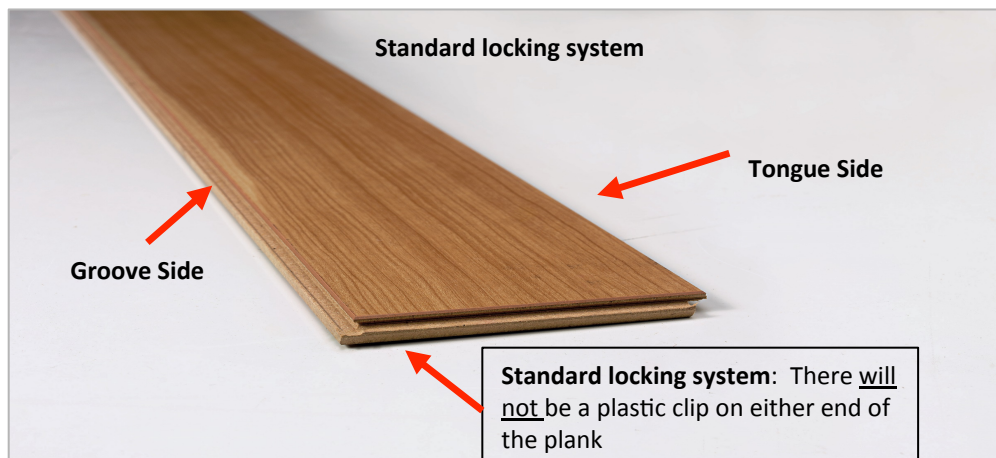

Wall Mounting Instructions

How to install your planks horizontally on a wall:

1. Remove baseboards from the accent wall and locate the wall studs using the stud finder tool. Mark vertical lines over all studs. (Figure 1)
2. Turn off power while working around wall outlets and light switches.
3. Snap chalk lines on the wall along the length of the studs.
4. Snap a horizontal chalk line on the bottom of the wall to maintain a level installation (for uneven subfloors).
5. Measure the distance from floor to ceiling and the length of the wall to determine the spacing of the first and last row of a horizontal installation.
6. Open at least three cartons of laminate to work from.
7. Lay out laminate planks on the floor to arrange and see the desired plank visuals and pattern.
8. Determine if the installation of laminate planks needs to be balanced between the floor and ceiling. This may require lengthwise cutting of the first and last rows of planks.
9. Maintain a 3/8" expansion space around the perimeter of the wall. (Figure 2) Connect the brad nailer to the air compressor and turn on the air compressor.
10. Use 1 1/2" to 2" long brads.
11. Place a premium urethane construction adhesive in the caulk gun and cut open the tip of the adhesive tube to achieve a 1/4" wide bead of adhesive. We recommend you apply the adhesive to the back of individual laminate planks in a serpentine pattern, which is the shape of an "S." Use a spacing of 3 to 4 inches between serpentine elements. (Figure 3)
12. **Standard Locking System:** Starting from right to left, place the first plank on the wall at the bottom right corner of the wall. Ensure that the groove side of the plank is facing up and the planks line up level with the horizontal chalk line.
Plastic Clip Locking System: Starting from left to right, place the first plank on the wall at the bottom left corner of the wall. Ensure that the groove side of the plank is facing up and the planks line up level with the horizontal chalk line.

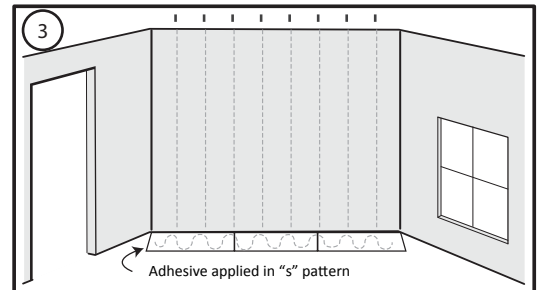
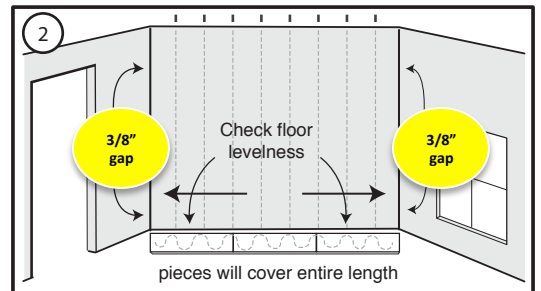
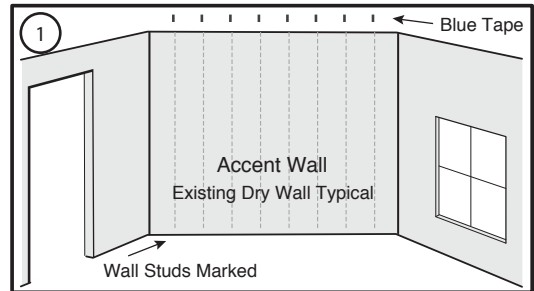

Wall Mounting Instructions

How to install your planks horizontally on a wall:

13. On the bottom row of planks only, face nail the planks (at the stud locations) in an area where wall base trim will cover the plank. Also on the bottom row and all subsequent rows thereafter, blind nail in the grooves of each plank every 16". Caution: Ensure that the hard backing of each plank is adhered directly to the wall. (Figure 4). Do not face nail any planks which are not on the bottom row.
14. Complete the first row by repeating the glue, lock, brad nail process.
15. After completing first row, use a cut plank from first row (if longer than 8") to start the second row.
16. Start the second row from the right side if using the **Standard Locking System** (or from the left side if using the **Plastic Clip Locking System**). **Cut and glue with urethane construction adhesive the first plank.** Fit plank by angling tongue into groove and wiggle into place. Use tapping block as needed. Blind nail a brad nail into each plank every 16" through the shallow area of the extended groove at each wall stud (Figures 4 & 5). Do not face nail second row or subsequent rows.
17. Using this angle and fold method (with accompanying blind nailing) continue installing planks on the wall. To achieve a random appearance, keep end joints of adjacent rows at least 8" apart throughout the installation. Beginning on the second row and continuing through subsequent rows, you may find it beneficial to use a tapping block on the long side of each plank to help the plank lock into the previous row. (Figure 8)
18. For the last row of the installation, use painters tape to mark the stud location for brad nailing. (Figure 8a)

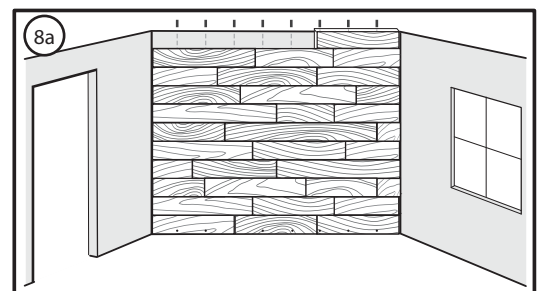
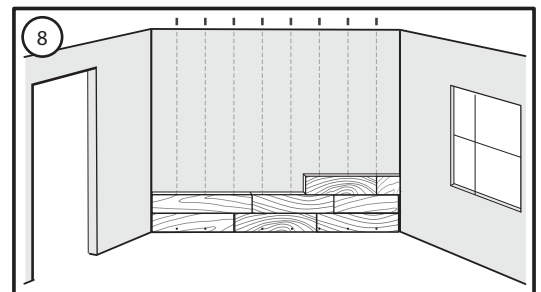
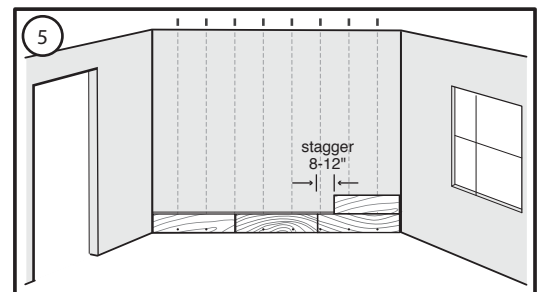
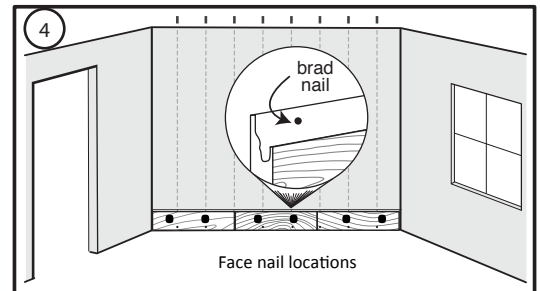

Wall Mounting Instructions

How to install your planks horizontally on a wall:

19. If necessary, the last row of planks may need to be ripped with a table saw.
20. Remember to maintain a 3/8" expansion space between the wall and the floor, the wall and the ceiling, and both adjacent walls.
21. Use quarter round for inside corners and ceiling. Finish with wall base of your choice. (Figure 9)

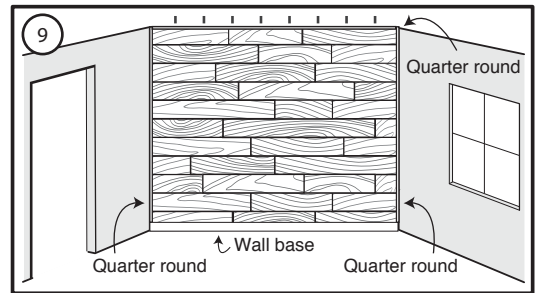

How to adjust for a diagonal installation:

A diagonal installation of laminate on walls is very similar to a horizontal installation, except that the entire installation is done at a 45-degree angle from the floor. Simply snap your initial chalk line at this 45-degree angle and proceed. For a diagonal installation of 45 degrees, the planks that meet the perimeter of the installation will need to be cut on a 45-degree angle.

How to install your planks on a diagonal:

1. Install a thin sheet of plywood over existing drywall.
2. Use your tape measure to measure the width of your wall to come up with a balanced layout. You may have to cut the width of the first and last rows to maintain a balanced layout.
3. Then measure the width of your starting plank; add a 1/4" to maintain your expansion space. Place a pencil mark onto the wall at the top and bottom of the starting wall.
4. Snap a chalk line along the starting wall.
5. Open at least 3 cartons of laminate to work with initially.
6. Lay out your planks on the floor to arrange and see the plank visuals and pattern.
7. Connect the brad nailer to the air compressor and turn on the air compressor.
8. Use 1-1/2" to 2" long brads.
9. Use a premium urethane construction adhesive in the caulk gun. Cut open the tip of the adhesive tube to achieve a 1/4" wide bead.
10. In a serpentine pattern, apply the adhesive to the back of the initial plank of the first row (for a horizontal install the first row is the bottom row).
11. Place plank on the wall such that the side groove of the plank is facing right.
12. Face nail the plank in an area where trim will cover the nails holes in the plank.
13. Also nail the plank through the groove at several locations. Caution: Ensure that the hard backing of each plank is adhered directly to the wall.
14. Apply adhesive (in serpentine manner) to the second plank and place the plank on the wall such that the end of the plank can be folded to lock into the groove end of the first plank installed.
15. Then brad nail the second plank in the same manner as initial plank.
16. Repeat glue, lock, brad nail process to complete first row.
17. After completing first row, use a cut plank from first row (if longer than 8") for start of second row.
18. Angle the initial plank of the second row into the adjacent plank(s) of the first row and fold the plank into place.

Wall Mounting Instructions

19. Do not face nail second row or subsequent rows. Instead, only blind nail into the side groove (after applying adhesive to the back of the plank).
20. Using this angle and fold method (with accompanying blind nailing) continue installing planks on the wall. To achieve a random appearance, keep end joints of adjacent rows at least 6" apart throughout the installation.
21. The last row of planks may need to be ripped with a table saw.
22. Remember to maintain a 3/8" expansion space.

After you have completed your installation:

Care and cleaning: Please use a dry wipe as your primary cleaning method. You can damp wipe with water only, but never use wet washing. If needed, you can use a cleaning solutions of one cup of vinegar per gallon of water OR 1/3 cup non-sudsing ammonia per gallon of water. Please NEVER use detergents, abrasive cleaners, soaps, waxes or polishes. When spills occur, please wipe them immediately. DO NOT allow moisture to remain on the product surface for longer than 30 minutes.

Hanging pictures and such: For hanging pictures and other objects on a laminate wall, you should drill clearance holes through the laminate and mount these objects directly to wall studs with screws or nails. Drill the clearance holes through the laminate at least 1/4" larger than the diameter of the fastener that will be used. You should NEVER attach things such as pictures, television mounts, or shelving units directly to the laminate wall. You should NEVER apply adhesive backed hooks or install screws or nails into the laminate wall for hanging objects.

How to adjust for a wainscoting installation:

1. Measure the length and width of the installed area to determine the total square footage area. Order that amount of flooring plus an additional 10% for incorrect cuts.
2. Remove all base and trim from accent wall. Measure from the floor a distance equal to your laminate plank plus one inch then level and mark the wall with a chalk line. With an electronic stud finder locate and mark wall studs also. (Figure 1)
3. Turn off power while working around wall outlets and light switches. Pay special attention to avoid contact with electrical wiring.
4. Inspect each plank for damage before installing. Do not install damaged planks.
5. Measure the width of your wall to begin coming up with your ideal layout. You may have to cut the width of the first and last rows to maintain a balanced design.
6. Measure the width of your first plank, then add a 1/4" to maintain the required expansion space. Use a pencil mark on the wall at the top and bottom of the wall.
7. Wainscoting is usually 36" in height. Use a chalk line both vertically and horizontally to ensure that the planks are cut the same length and your installation is straight.

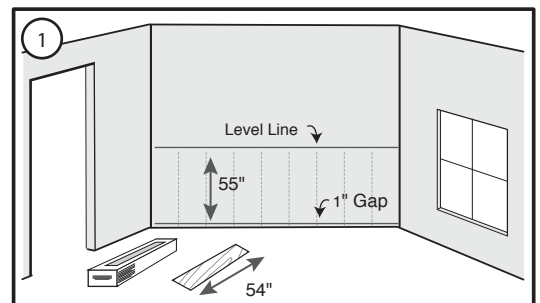

Wall Mounting Instructions

8. Place one plank against the wall and align at the top to test fit. Start from the left side with the tongue side toward the wall (Figure 2a).
9. Apply construction adhesive to the back of your starting plank in a serpentine pattern (Figure 3). Working from left to right, place onto the wall. Be sure that the tongue faces the left adjacent wall
10. Adhere the plank to the wall leaving a $\frac{3}{8}$ " gap (A) from the corners of the wall and a 1" gap (B) at bottom. Drive brad nails $\frac{1}{2}$ " from the top and bottom of each plank to secure to wall. Place nails where the trim will cover. (Figure 4)
11. Continue with the installation for each subsequent plank by first applying adhesive to the back side of the plank in an "S" pattern. Then angle the groove over the tongue of the previous plank and wiggle into place. Tighten joints as needed with a tapping block or pull bar. Finally, drive brad nails $\frac{1}{2}$ " from the top and bottom of each plank to secure to wall. Place nails where the trim will cover.
12. Finish wainscot accent to ending wall. (Figure 5)

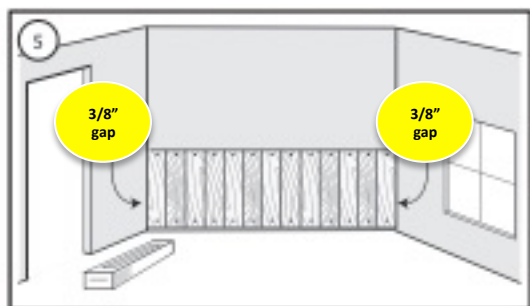
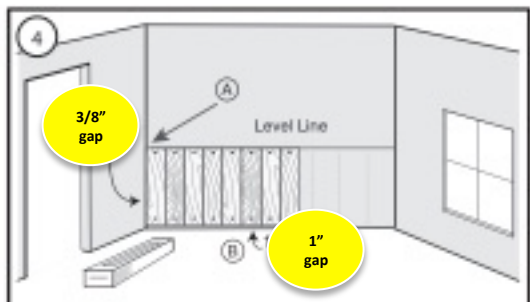
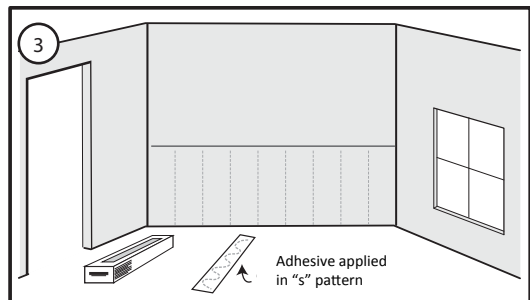
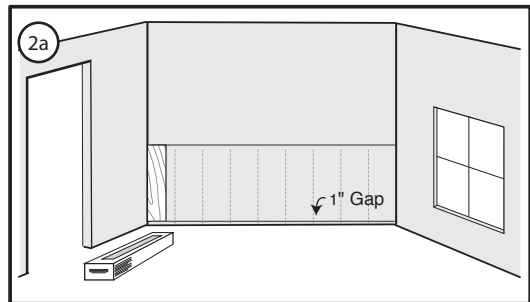

Wall Mounting Instructions

13. After the installation of all your planks is completed, you should add your trim pieces. (Figure 6)
14. Your base molding should go on first. Then add your chair rail trim to the top of your planks. Place the inside and outside trim pieces onto the wall.

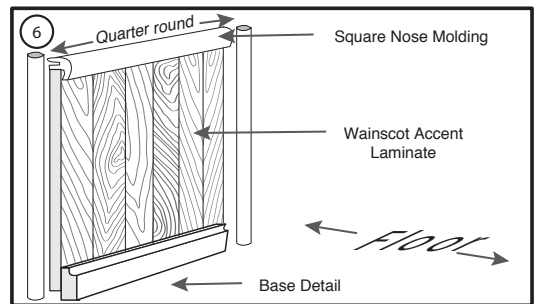

How to install around light switches or power outlets:

We recommend a jig saw or coping saw can be used to cut laminate planks. This will allow proper fit of the outlets or switches. Begin by removing the outlet covers so you can cut the planks to fit around them. Then, reinstall the faceplate, which may require a spacer between the outlet and the mounting box or a plastic washer beneath the cover and a longer screw to hold the faceplate to the outlet. You could also use spark rings or box extenders in some situations.

How to complete your installation:

When installation is done, clean any excess adhesive that may be on the surface using mineral spirits or acetone. Then clean the surface with commercially available laminate cleaner. Fill any holes with the appropriate blended filler. We recommend that you control humidity levels in the room within the 35-55% range because your wall can be affected by varying humidity levels in your house.

Distributed by:

Swiss Krono LLC 810 Technology Drive Barnwell, SC 29812
(800) 777-5145 www.SwissKronoUSA.com