

# WORX®

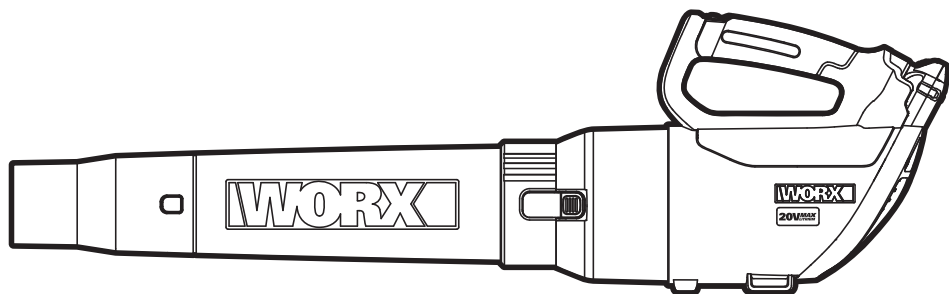

<b>20V Max Lithium Blower</b>	<b>EN</b>	<b>P04</b>
<b>20V Max Lithium Blower</b>	<b>F</b>	<b>P12</b>
<b>20V Max Lithium Blower</b>	<b>ES</b>	<b>P18</b>



HELPLINE NUMBER  
NUMERO DU SERVICE D'ASSISTANCE  
NUMERO DE LINEA DE AYUDA  
1-866-354-WORX (9679)

## WG546 WG546.9

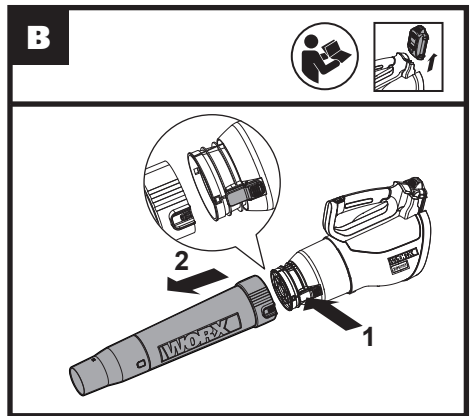
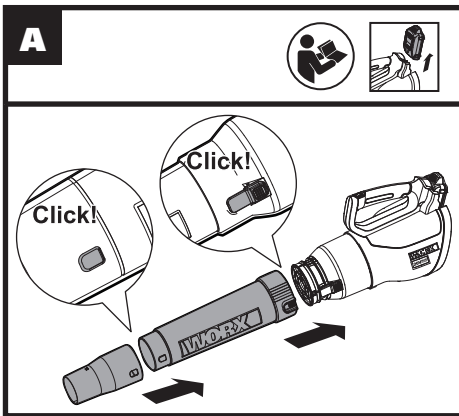
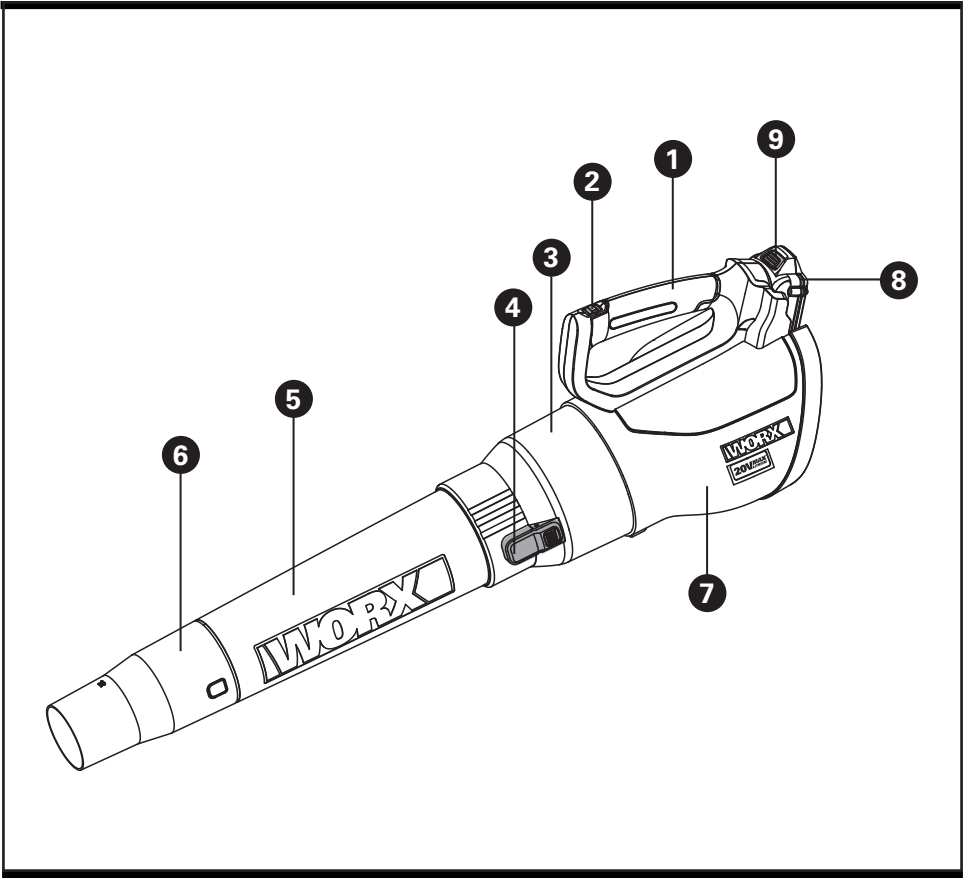

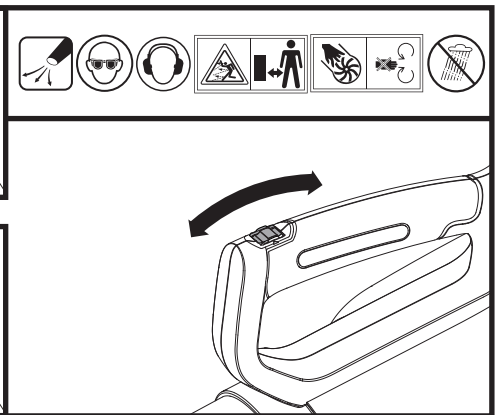
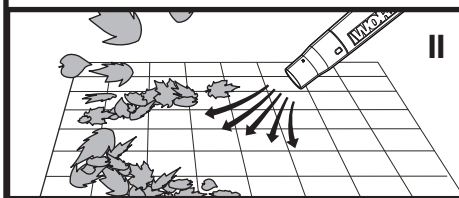
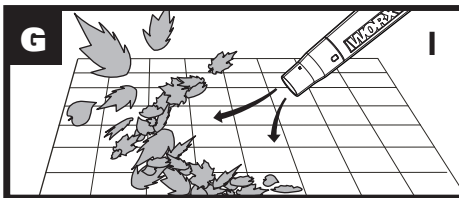
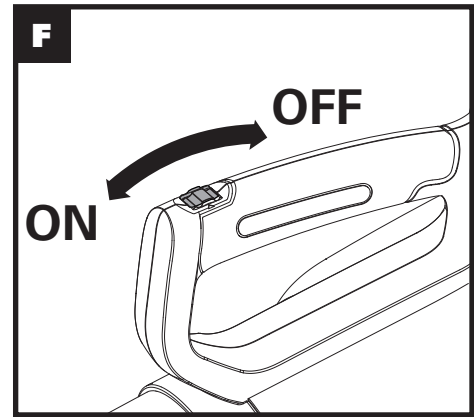
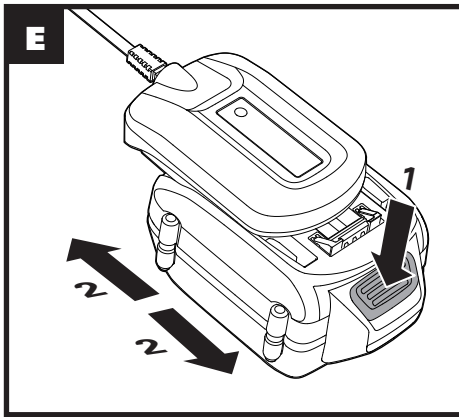
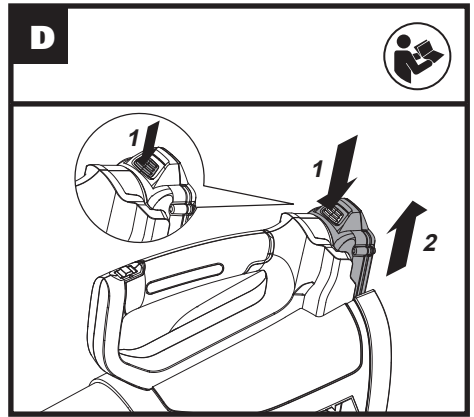
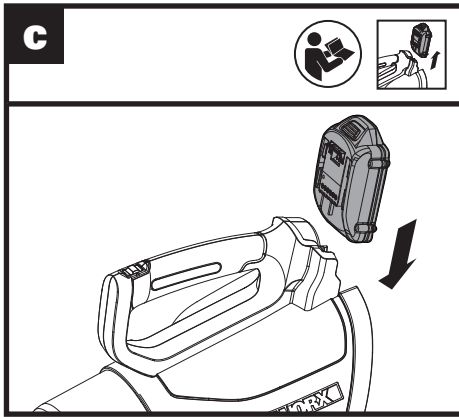

---

**1. HANDLE**

---

**2. ON/OFF SWITCH**

---

**3. FAN HOUSING**

---

**4. TUBE RELEASE BUTTON**

---

**5. UPPER BLOWER TUBE**

---

**6. LOWER BLOWER TUBE**

---

**7. MOTOR HOUSING**

---

**8. BATTERY PACK**

---

**9. BATTERY PACK RELEASE BUTTON**

---

**Not all the accessories illustrated or described are included in standard delivery.**

## TECHNICAL DATA

	<b>WG546</b>	<b>WG546.9</b>
Rated voltage	20V $\approx$ Max*	
Air speed	I: 60 mph II: 90 mph	
Air volume	I: 225 cfm II: 340 cfm	
Charging time	5hr(approx.)	/
Machine weight	5.7lbs	4.9lbs

\* Voltage measured without workload. Initial battery voltage reaches maximum of 20 volts. Nominal voltage is 18 volts.

## ACCESSORIES

	<b>WG546</b>	<b>WG546.9</b>
Battery pack	1 (WA3525)	/
Charger	1 (WA3742)	/

We recommend that you purchase your accessories from the same store that sold you the tool. Use good quality accessories marked with a well-known brand name. Choose the type according to the work you intend to undertake. Refer to the accessory packaging for further details. Store personnel can assist you and offer advice.

 **WARNING:** Some dust created by power sanding, sawing, grinding, drilling and other construction activities contains chemicals known to the state of California to cause cancer, birth defects or other reproductive harm. Some examples of these chemicals are:

- Lead from lead-based paints;
- Crystalline silica from bricks and cement and other masonry products and
- Arsenic and chromium from chemically-treated lumber.

Your risk from these exposures varies, depending on how often you do this type of work. To reduce your exposure to these chemicals: work in a well ventilated area, and work with approved safety equipment, such as those dust masks that are specially designed to filter out microscopic particles.

 **WARNING:** This product maybe contains lead, phthalate or other chemicals known to the State of California to cause cancer, birth defects and other reproductive harm. Please wash your hands after use.

## IMPORTANT SAFETY INSTRUCTIONS

 **WARNING:** When using electric gardening appliances, basic safety precautions should always be followed to reduce the risk of fire, electric shock, and personal injury, including the following:

 **WARNING: Read all instructions**

### FOR ALL APPLIANCES

- 1) Avoid Dangerous Environment - Don't use appliances in damp or wet locations.
- 2) Don't Use In Rain.
- 3) Keep Children Away - All visitors should be kept at a distance from work area.
- 4) Dress Properly - Do not wear loose clothing or jewelry. They can be caught in moving parts. Use of rubber gloves and substantial footwear is recommended when working outdoors. Wear protective

- hair covering to contain long hair.
- 5) Use Safety Glasses - Always use face or dust mask if operation is dusty.
- 6) Use Right Appliance - Do not use appliance for any job except that for which it is intended.
- 7) Don't Force Appliance - It will do the job better and with less likelihood of a risk of injury at the rate for which it was designed.
- 8) Don't Overreach - Keep proper footing and balance at all times.
- 9) Stay Alert - Watch what you are doing. Use common sense. Do not operate appliance when you are tired.
- 10) Store Idle Appliances Indoors - When not in use, appliances should be stored indoors in dry, and high or locked-up place - out of reach of children.
- 11) Maintain Appliance With Care - Keep cutting edge sharp and clean for best performance and to reduce the risk of injury. Follow instructions for lubricating and changing accessories. Keep handles dry, clean, and free from oil and grease.
- 12) Check Damaged Parts - Before further use of the appliance, a guard or other part that is damaged should be carefully checked to determine that it will operate properly and perform its intended function. Check for alignment of moving parts, binding of moving parts, breakage of parts, mounting, and any other condition that may affect its operation. A guard or other part that is damaged should be properly repaired or replaced by an authorized service center unless indicated elsewhere in this manual.

### FOR ALL BATTERY - OPERATED GARDENING APPLIANCES

1. For all battery-operated gardening appliances:
  - a) Do not charge appliance in rain, or in wet locations.
  - b) Do not use battery-operated appliance in rain.
  - c) Remove or disconnect battery before servicing, cleaning or removing material from the gardening appliance.

2. For all battery-operated products employing a detachable or separable battery:

- a) Use only the following type and size battery(ies): WA3525/WA3520
- b) Do not dispose of the battery(ies) in a fire. The cell may explode. Check with local codes for possible special disposal instructions.
- c) Do not open or mutilate the battery(ies). Released electrolyte is corrosive and may cause damage to the eyes or skin. It may be toxic if swallowed.
- d) Exercise care in handling batteries in order not to short the battery with conducting materials such as rings, bracelets, and keys. The battery or conductor may overheat and cause burns.

3. Avoid unintentional starting – Do not insert the battery with your finger on the switch. Be sure the switch is off when inserting the battery.

#### **SAVE THESE INSTRUCTIONS**

6

## **ADDITIONAL SAFETY WARNINGS FOR BLOWER IMPORTANT SAFETY INSTRUCTIONS**

When using an electrical appliance, basic precautions should always be followed, including the following:

## **READ ALL INSTRUCTIONS BEFORE USING THIS APPLIANCE**

 **WARNING! To reduce the risk of fire, electric shock, or injury:**



1. To reduce the risk of electric shock –

Do not use on wet surfaces. Do not expose to rain. Store indoors.

2. Do not allow to be used as a toy. Close attention is necessary when used by or near children.
3. Use only as described in this manual. Use only manufacturer's recommended attachments.
4. If appliance is not working as it should, has been dropped, damaged, left outdoors, or dropped into water, return it to a service center.
5. Keep hair, loose clothing, fingers, and all parts of body away from openings and moving parts.
6. Do not charge the unit outdoors.
7. Use only the charger supplied by the manufacturer to recharge.
8. Do not incinerate the appliance even if it is severely damaged. The batteries can explode in a fire.
9. Do not put any object into openings. Do not use with any opening blocked; keep free of dust, lint, hair, and anything that may reduce air flow.
10. Do not handle plug or appliance with wet hands.
11. Do not leave appliance when plugged in. Unplug from outlet when not in use and before servicing.
12. Turn off all controls before unplugging.
13. Use extra care when cleaning on stairs.









## **GENERAL SAFETY WARNINGS FOR BATTERY PACK**

- 1)  **WARNING: Risk of fire and burns. Do not disassemble, heat above 100°C (212°F), or incinerate. Do not expose cells or batteries to heat or fire. Avoid storage in direct sunlight.**

- 2) **Dispose of used battery promptly. When disposing of secondary cells or batteries, keep cells or batteries of different electrochemical systems separate from each other.**
- 3) **Keep battery out of reach of children and in original package until ready to use.**
- 4) **Never put batteries in mouth. If swallowed, contact your physician or local poison control center.**
- 5) **CAUTION – The battery used in this device may present a risk of fire or chemical burn if mistreated. Replace battery with WORX only. Use of another battery may present a risk of fire or explosion**
- 6)  **WARNING: Do not use a visibly damaged battery pack or appliance as applicable.**
- 7)  **WARNING: Do not modify or attempt to repair the appliance or the battery pack as applicable.**
- 8) **BATTERY MUST BE RECYCLED**
- 9) **Do not short-circuit a cell or battery. Do not store cells or batteries haphazardly in a box or drawer where they may short-circuit each other or be short-circuited by conductive materials.**
- 10) **Do not subject cells or batteries to mechanical shock.**
- 11) **Keep cells and batteries clean and dry.** Wipe the cell or battery terminals with a clean dry cloth if they become dirty.
- 12) **Do not maintain secondary cells and batteries on charge when not in use.**
- 13) **Retain the original cell and battery literature for future reference.**
- 14) **Do not use any charger other than that specifically provided for use with the equipment.** Secondary cells and batteries need to be charged before use. Always use the correct charger and refer to the manufacturer's instructions or equipment manual for proper charging instructions.
- 15) When possible, remove the battery from the equipment when not in use.
- 16) Prevent unintentional starting. Ensure the switch is in the off-position before connecting to battery pack, picking up or carrying the appliance. Carrying the appliance with your finger on the switch or energizing appliance that have the switch on invites accidents.
- 17) Disconnect the battery pack from the appliance before making any adjustments, changing accessories, or storing appliance. Such preventive safety measures reduce the risk of starting the appliance accidentally.
- 18) Under abusive conditions, liquid may be ejected from the battery; avoid contact. If contact accidentally occurs, flush with water. If liquid contacts eyes, additionally seek medical help. Liquid ejected from the battery may cause irritation or burns.
- 19) Have servicing performed by a qualified repair person using only identical replacement parts. This will ensure that the safety of the product is maintained.

## SAVE THESE INSTRUCTIONS

## SYMBOLS



	To reduce the risk of injury, user must read instruction manual
	Wear eye protection
	Wear ear protection
	Keep bystanders away
	Warning of hazard
	Do not use in the rain or leave outdoors while it is raining.
	Remove battery from the socket before carrying out any adjustment, servicing or maintenance.
 Li-Ion	Li-Ion battery, battery must be recycled
	<b>call2recycle</b> POSITEC Inc. has established a partnership with the RBRC Corporation to recycle any Positec batteries with the RBRC-call2recycle seal. For environmental protection, please do not discard batteries in the trash. After the batteries' life cycle is ended, then please call 1-800-822-8837 for a free service that will properly dispose of the battery.

## OPERATION

### INTENDED USE:

The blower is intended for residential use only. Use the blower outdoors to move yard debris as needed.

### Assembly and Operation

ACTION	FIGURE
Assembling & disassembling the BlowerTube	See Fig. A & B
Installing & Removing the Battery Pack <b>NOTE:</b> Depress the battery release button to release battery pack from your tool. After recharging, insert the battery pack into tool's battery port. A simple push and slight pressure will be sufficient.	See Fig. C & D
Charging the battery More details can be found in WA3742's manual  <b>WARNING!</b> The charger and battery pack are specially designed to work together, so do not attempt to use any other devices. Never insert or allow metallic objects into your charger or battery pack connections because of an electrical failure and hazard will occur. BEFORE USING YOUR CORDLESS BLOWER Your battery pack is UNCHARGED, you must charge before use.	See Fig. E
Starting & Stopping  <b>WARNING!</b> The tool runs for a few seconds after it has been switched off. Let the motor come to a complete standstill before setting the tool down.	See Fig. F



Blowing

### USER TIPS

- Hold the blow tube approx 8" above the ground when operating the tool.  
Use a sweeping motion from side to side. Advance slowly keeping the accumulated debris/leaves in front of you.
- After blowing the debris/leaves into a pile, it is easy to dispose of the pile.



### CAUTION!

- Do not blow hard objects such as nails, bolts, or rocks.
- Do not operate the blower near bystanders or pets.
- Use extra care when cleaning debris from stairs or other tight areas.
- Wear safety goggles or other suitable eye protection, long pants, and shoes.

See Fig. G

## CLEANING THE TOOL

**Clean the tool regularly.**



**WARNING!** Keep your product dry.

Under no circumstances spray with water.

- To clean the tool, use only mild soap and a damp cloth.
- Do not use any type of detergent, cleaner or solvent which may contain chemicals that could seriously damage the plastic.
- Self lubricating bearings are used in your product, therefore lubrication is not required.

**WORX**  
**it's your nature**  
**[www.worx.com](http://www.worx.com)**

Copyright © 2015, Positec. All Rights Reserved.

Copyright © 2015, Positec. Tous droits réservés.

© Derechos reservados 2015, Positec. Todos los derechos reservados.