

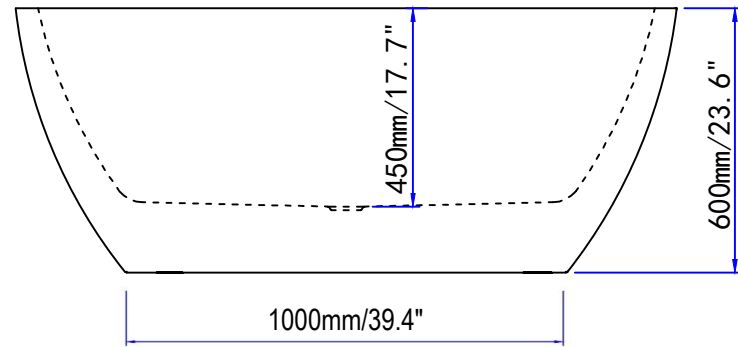

Streamline

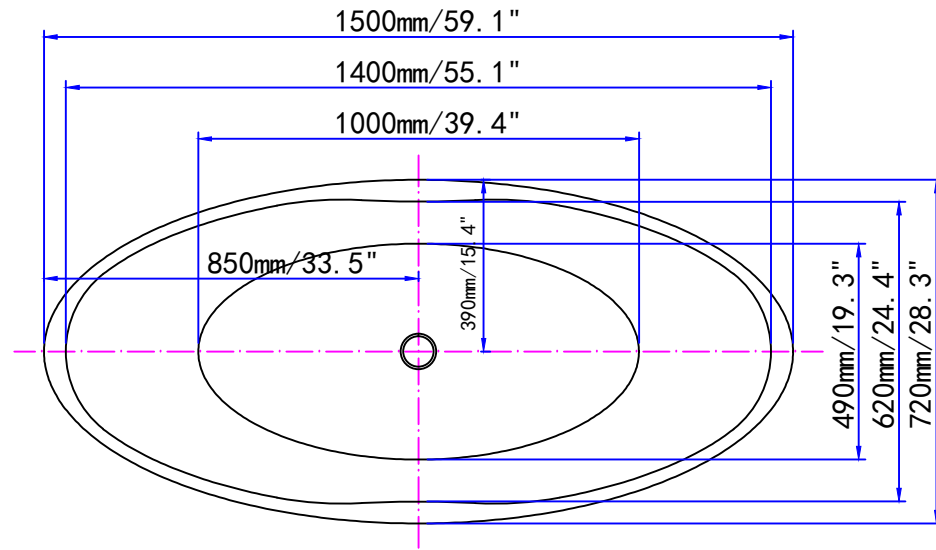

N-1301-59FSWH-FM