

Table of Contents

SUPCO Part Number Index ii - xvii

REFRIGERATION

	Page
Cold Controls	1 - 5
Defrost Timers	5 - 8
Evaporator Fan Motors	9 - 14
Utility Fan Motors	15 - 17
Fan Blades	18 - 19
Icemaker Installation & Repair	20 - 30
Relays, Overloads & Hardstarts	31 - 34
Door Gaskets	35 - 44
Switches	45
System Charging Components	46 - 47
Condensate Pans	48
Defrost Heaters	48 - 54
Defrost Thermostats	55 - 60
Shelves and Shelf Supports	61

HVAC COMPONENTS

	Page
Hard Starts	62
Relays	63 - 64
Capacitors	65 - 66
Heat Sequencers	67
Wall Thermostats & Guards	68 - 72

DISHWASHER

	Page
Electrolux (D & M)	73
General Electric	73 - 75
Whirlpool	76
Universal	77

LAUNDRY - WASHER

	Page
Alliance (Speed Queen)	78
Electrolux	78
General Electric	79 - 80
Maytag	81 - 83
Whirlpool	84 - 88
Universal	89 - 90

LAUNDRY - DRYER

	Page
Alliance (Speed Queen)	90 - 93
Electrolux	94 - 96
General Electric	97 - 102
Maytag	103 - 108
Whirlpool	109 - 113
Thermostats -Universal	114 - 117

LAUNDRY - UNIVERSAL

	Page
Switches	118 - 119
Belts	120 - 124

RANGE

	Page
Surface Elements & Receptacles	125 - 129
Pans, Bowls & Rings	130 - 134
Oven Elements	135 - 141
Switches, Lights & Wire	141 - 143
Door Gaskets	144
Oven Racks	144
Oven Igniters	145 - 147
Infinite Switches & Knobs	148 - 149
Receptacles & Lights	150

TOOLS & TEST INSTRUMENTS

	Page
Infrared Thermometers	151
Thermometers & Alarms	152 - 155
Specialty & Multi Meters	156 - 158
Innovative Hand Tools	159 - 163
Tools & Accessories	164 - 166
Terminal & Connectors	167 - 171
Chemicals	172 - 178



Sealed Unit Parts Co., Inc.

PO Box 21 • 2230 Landmark Place • Allenwood, NJ 08720 • USA

Phone (732)223-6644 • Fax (732)223-1617

www.supco.com • info@supco.com

Direct Replacement Cold Controls

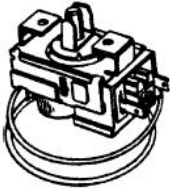
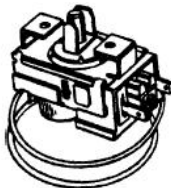
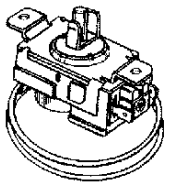
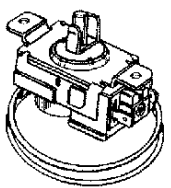
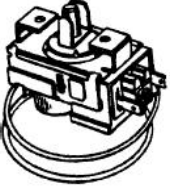
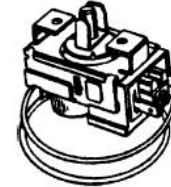
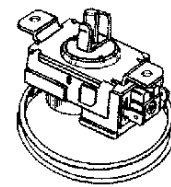
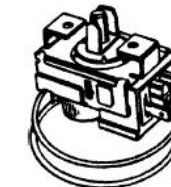
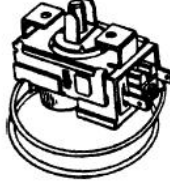
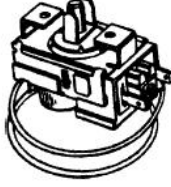
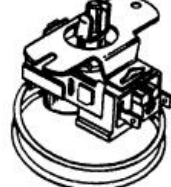
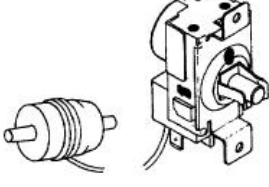
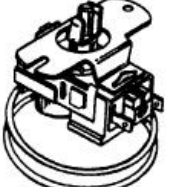
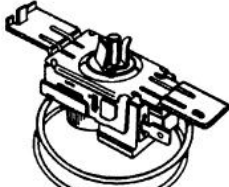
Electrolux		General Electric	
5303200810 GC161	5304404821 GC193	WR9X208 GC116	WR9X355 GC140
			
N.I. 40 N.O. 34	N.I. 35 N.O. 8.5	N.I. 37.5 N.O. -10.5	N.I. 36 N.O. 26
General Electric			
WR9X405 GC175	WR9X411 GC177	WR9X491 GC188	WR9X499 GC192
			
N.I. 28 N.O. 19	N.I. 32 N.O. 22	N.I. 33 N.O. 19	N.I. 38 N.O. 23
General Electric		Maytag	
WR9X501 GC178	WR9X517 GC190	68601-6 GC183	61005789 GC195
			
N.I. -5 N.O. -37.5	N.I. 37.5 N.O. 25	N.I. 40 N.O. 32	N.I. 41 N.O. 21
Whirlpool		Direct Replacement Cold Controls	
819470 GC185	1123394 GC182	<p>Some of the most popular refrigerator cold controls are now available from SUPCO. The direct replacement series offers quick and simple installation, proper cap tube lengths, and temperature settings.</p> <p>Cap = Length of capillary tube or style N.I. = Nominal In (or Mid-range In) N.O. = Nominal Off (or Mid-range Off)</p>	
			
N.I. 29.5 N.O. 16.5	N.I. 29.5 N.O. 16.5	See Cross References On Page 2 -3	

Part numbers and illustrations are intended solely for identification.

1 Items offered for sale are not represented to be manufactured by the company that built the original model.

Direct Replacement Cold Controls Cross Reference

Cutler Hammer		Electrolux (Cont.)		Gemline (Cont.)		General Electric (Cont.)	
Part No.	SUPCO No.	OEM Part No.	SUPCO No.	OEM Part No.	Supco No.	OEM Part No.	SUPCO No.
9530N567	GC185	3006112	GC161	GC188	GC188	WR9X499	GC192
9530N568	GC185	3017815	GC161	GC190	GC190	WR9X501	GC178
9530N569	GC185	3200810	GC161	GC192	GC192	WR9X5054	GC175
9530N592	GC185	5300086493	GC161	GC193	GC193	WR9X5090	GC175
9530N640	GC161	5303001453	GC161	General Electric		WR9X5092	GC175
9530N672	GC185	5303001525	GC161	OEM Part No.	SUPCO No.	WR9X5094	GC175
9530N675	GC185	5303006112	GC161	WR9X115	GC116	WR9X5101	GC175
9530N678	GC161	5303200810	GC161	WR9X125	GC116	WR9X5106	GC175
9530N712	GC185	5303321453	GC193	WR9X128	GC116	WR9X5107	GC175
9530N757	GC161	5304404821	GC193	WR9X145	GC116	WR9X5121	GC175
9530N772	GC185	5308000068	GC161	WR9X158	GC116	WR9X517	GC190
9530N787	GC185	5308002726	GC161	WR9X177	GC116	WR50X5002	GC175
9530N790	GC185	5308003635	GC161	WR9X182	GC116	General Electric Mfg.	
9530N792	GC185	5308007095	GC161	WR9X183	GC116	OEM Part No.	SUPCO No.
9530N793	GC183	5308015762	GC161	WR9X208	GC116	3ART5C167	GC195
9530N793	GC185	5308015763	GC161	WR9X209	GC116	3ART5C197	GC190
9530N805	GC185	5308017217	GC161	WR9X216	GC116	3ART5C212	GC195
9530N818	GC161	5308017218	GC161	WR9X223	GC140	3ART5LP5	GC185
9530N848	GC185	5308017445	GC161	WR9X237	GC116	3ART5MA16	GC161
9530N856	GC161	86493	GC161	WR9X239	GC140	3ART5VAA14	GC192
9530N861	GC161	G162205-01	GC161	WR9X242	GC175	3ART5VC131	GC188
9530N875	GC185	G162205-05	GC161	WR9X245	GC140	3ART5VC163	GC188
9530N888	GC185	G162205-06	GC161	WR9X246	GC140	3ART5VC44	GC183
9530N900	GC161	G162205-07	GC161	WR9X248	GC140	3ART5VC84	GC140
9531N277	GC300	G162205-10	GC161	WR9X252	GC140	3ART5VC96	GC140
9530N1075	GC183	G162205-11	GC161	WR9X255	GC175	3ART5VC99	GC140
9530N1086	GC161	G162205-12	GC161	WR9X257	GC140	3ART5VCH35	GC175
9530N1159	GC161	G162505-05	GC161	WR9X259	GC116	3ART5VG1	GC161
9530N1162	GC161	G162667	GC161	WR9X279	GC140	3ART5VG10	GC161
9530N1189	GC185	G162667-01	GC161	WR9X286	GC140	3ART5VG15	GC161
9530N1190	GC185	G162667-05	GC161	WR9X296	GC116	3ART5VG16	GC161
9530N1199	GC185	G162667-06	GC161	WR9X299	GC140	3ART5VG21	GC161
9530N1209	GC185	G162667-07	GC161	WR9X333	GC140	3ART5VG3	GC161
9530N1221	GC183	G162667-10	GC161	WR9X337	GC116	3ART5VG4	GC161
9530N1254	GC183	G162667-11	GC161	WR9X338	GC116	3ART5VG6	GC161
9530N1255	GC183	G162667-12	GC161	WR9X343	GC140	3ART5VG8	GC161
9530N1256	GC183	G162677-05	GC161	WR9X347	GC116	3ART5VH39	GC177
9530N1263	GC183	G171810-01	GC161	WR9X352	GC175	3ART5VN11	GC182
9530N1303	GC183	G185543-11	GC161	WR9X353	GC140	3ART6A11	GC116
Electrolux		R162667-11	GC161	WR9X355	GC140	3ART6A14	GC116
OEM Part No.	Supco No.	Gemline		WR9X357	GC140	3ART6A22	GC116
08000068	GC161	OEM Part No.	Supco No.	WR9X360	GC140	3ART6A25	GC116
08002726	GC161	GC116	GC116	WR9X398	GC178	3ART6A32	GC116
08003635	GC161	GC140	GC140	WR9X399	GC178	3ART6A9	GC116
08007095	GC161	GC157	GC185	WR9X401	GC175	3ART6MA4	GC116
08015762	GC161	GC161	GC161	WR9X405	GC175	3ART6VA32	GC116
08015763	GC161	GC170	GC183	WR9X411	GC177	3ART6VA4	GC116
08017217	GC161	GC175	GC175	WR9X422	GC178	3ART6VC25	GC116
08017218	GC161	GC177	GC177	WR9X446	GC177	3ART6VC32	GC116
08017445	GC161	GC178	GC178	WR9X448	GC188	3ART6VC34	GC116
3001336	GC161	GC182	GC182	WR9X458	GC188	3ART6VC36	GC116
3001453	GC161	GC183	GC183	WR9X460	GC178	3ART6VC43	GC116
3001525	GC161	GC185	GC185	WR9X491	GC188	3ART6VC44	GC116

Direct Replacement Cold Controls Cross Reference

General Electric Mfg. (Cont.)		Whirlpool		Whirlpool (Cont.)	
OEM Part No.	SUPCO No.	OEM Part No.	SUPCO No.	OEM Part No.	SUPCO No.
3ART6VC45	GC116	530764	GC185	1105693	GC182
3ART6VC54	GC116	547585	GC185	1105694	GC182
3ART8VC1	GC116	548761	GC185	1107331	GC185
3ART8VC3	GC116	548762	GC185	1108001	GC185
3ART8VC4	GC116	549679	GC185	1108002	GC185
3ARTVC1	GC116	549682	GC185	1108003	GC185
Maytag		850031	GC185	1108008	GC182
OEM Part No.	SUPCO No.	850046	GC185	1108010	GC182
52881-5	GC183	850447	GC185	1108614	GC185
52881-24	GC183	850448	GC185	1114238	GC182
52881-25	GC183	850754	GC185	1114241	GC182
52881-33	GC183	850881	GC185	1115076	GC185
52881-34	GC183	850955	GC185	1123212	GC182
52881-36	GC183	850956	GC185	1123213	GC182
52881-45	GC183	850957	GC185	1123393	GC182
52881-47	GC183	851398	GC185	1123394	GC182
61005789	GC195	851399	GC185	1127884	GC182
66545-1	GC183	851400	GC185	1129617	GC182
66545-2	GC183	851612	GC185	2154974	GC182
68119-1	GC183	851931	GC185	2157229	GC182
68119-2	GC183	851932	GC185	2157231	GC182
68119-3	GC183	851933	GC185	2162293	GC182
68119-5	GC183	934382	GC185	2162425	GC182
68119-6	GC183	936055	GC185	2162427	GC182
68601-1	GC183	936056	GC185	2176748	GC182
68601-2	GC183	937272	GC185		
68601-3	GC183	937273	GC185		
68601-4	GC183	937274	GC185		
68601-5	GC183	940036	GC185		
68601-6	GC183	940037	GC185		
68601-7	GC183	940038	GC185		
68601-8	GC183	942758	GC182		
77194-4	GC195	942759	GC182		
Robertshaw		942760	GC182		
OEM Part No.	SUPCO No.	945447	GC185		
3030-116	GC116	945456	GC185		
3030-11F	GC116	978559	GC185		
3030-140	GC140	989274	GC185		
3030-14J	GC140	989275	GC185		
3030-157	GC157	989276	GC185		
3030-15G	GC157	989277	GC185		
3030-161	GC161	989278	GC185		
3030-170	GC170	989279	GC185		
3030-178	GC178	989533	GC185		
3030-17H	GC178	989534	GC185		
3030-305	GC175	989565	GC185		
3030-314	GC183	989566	GC185		
3030-31D	GC183	989569	GC185		
CC-112	GC183	989570	GC185		
CC-124	GC161	989571	GC185		
CC-157	GC183	989572	GC185		
CC-300	GC116	989574	GC185		
RC32-1561M	GC193	989699	GC185		

Universal Cold Controls

GC400 Series Cycle Defrost Controls Constant Cut-in Universal Replacement

Available
Spring 2007

The GC400 series controls have a 39°F constant cut-in to provide an automatic defrost with each compressor cycle, while maintaining safe food temperatures. The dial controls the differential, changing the cut-out temperature while maintaining a constant cut-in temperature. Universal mounting hardware insures these controls will replace wide range of controls.

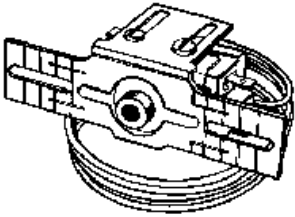

SUPCO Part No.	Calibration °F				Capillary Length
	Norm Off	Warm Off	Cold Off	Cut-In	
GC401	3	-11	-23	39	51"
GC405	12	-5	-15	39	60"
GC410	12	24	5	39	40"

Thermostats rated 125 VAC, 1/2 HP, 20 Amps F.L - 80 Amps L.R., SPST switch action.

GC500 Series Cold Controls Constant Differential Universal Replacement

Available
Spring 2007

The GC500 series constant differential controls always maintain the same difference between on and off temperature over the range of the control. The knob varies the operating temperature while the differential remains constant. These controls are ideally suited for "Frostfree" refrigerators and conventional refrigeration units. Universal mounting hardware insures these controls will replace wide range of controls.

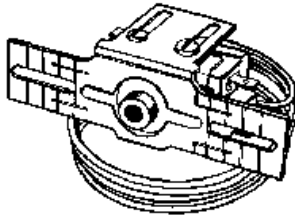

SUPCO Part No.	Normal °F		Calibration °F		Diff °F	Capillary Length
	Off	On	Warm Off	Cold On		
GC501	9	20	38	-16	11	42"
GC503	9	26	42.5	-16	17	42"
GC505	31	36	49	16	5	24"
GC506	18	31	48.5	-7	13	24"

Thermostats rated 125 VAC, 1/2 HP, 20 Amps F.L - 80 Amps L.R., SPST switch action.

GC600 Series Cold Controls Constant Differential Universal Replacement

Available
Spring 2007

The GC600 series constant differential controls always maintain the same difference between on and off temperature over the range of the control. The knob varies the operating temperature while the differential remains constant. These controls are designed for freezers, offering the most popular temperatures and capillary lengths. Universal mounting hardware insures these controls will replace wide range of controls.

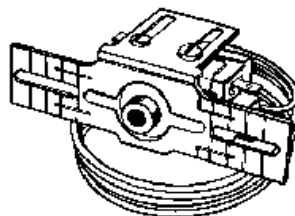

SUPCO Part No.	Normal °F		Calibration °F		Diff °F	Capillary Length
	Off	On	Warm Off	Cold On		
GC601	-5	4	22	-29	9	78"
GC602	-13	0	12	-30	13	78"
GC604	-12	6	20	-34	18	36"
GC607	-8	1	13	-23	9	31"

Thermostats rated 125 VAC, 1/2 HP, 20 Amps F.L - 80 Amps L.R., SPST switch action.

Universal Cold Controls

Available
Spring 2007

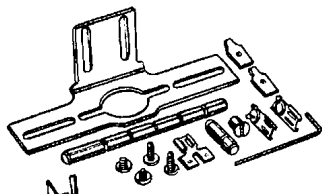

GC700 Series for Air Conditioners Universal Replacement

The GC700 series universal replacement controls give wide application coverage with a minimum of stock. The hardware accessory pack covers most major brands for a wide range of Room Air Conditioner applications.

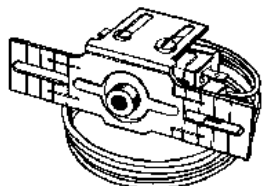

SUPCO Part No.	Range °F		Diff °F	Capillary Details		Electrical Ratings		
	Off	On		Length	Style	120 / 208 / 240 VAC		
			Switch			F.I.A.L.	R.A	
GC701	52	93	6	18"	Air Coil	SPST	20 A	80 A
GC702	52	93	6	36"	Straight	SPST	30 A	125A
GC707	52	93	6	36"	Straight	SPDT	25A	80A



Temporary Cold Controls

- Temporary Emergency Universal Replacement
- Keeps Equipment Up & Running Until Exact Replacement or Permanent Control Is Installed
- Can Be Used As Permanent Control
- Three Mounting Options Available Suction Cup, Velcro or Screw Mounting
- Safe & Easy Installation
- Domestic & Commercial Refrigerators & Freezers

SUPCO Part No.	Temperature Range				Diff. °F	Application
	Range	Cold	Medium	Warm		
SC1000	28°F to 45°F	28°F to 34°F	33°F to 39°F	39°F to 45°F	6°F	Refrigerator
SC1002	-6°F to 40°F	-6°F to 1°F	-6°F to 40°F	-6°F to 40°F	7°F	Refrigerator / Freezer

Thermostats rated 125 VAC, 1/2 HP, 20 Amps F.L - 80 Amps L.R., SPST switch action.

Defrost Timers



EDT Series Electronic Adjustable Defrost Timers

- Universal Replacement
- Electronic Circuitry
- Adjustable Defrost Frequency 4 to 12 Hours
- Adjustable Defrost Time 10 to 35 Minutes
- Available in 115 & 208/240 Volts
- Standard Size & Mounting To Fit Most Applications
- Standard Terminal Configuration To Accommodate Most Connections
- No Ground Wire
- Dust Proof Case
- Quiet Operation & Durability
- Replaces Most Defrost Timers In Domestic & Commercial Refrigerators / Freezers

SUPCO No.	Voltage	Hertz	Max. Compressor Rating	Max. Resistive Load
EDT10	120	50 / 60	1/3 HP	10 Amp
EDT20	208 / 240	50 / 60	1/3 HP	5 Amp
EDT11	120	50 / 60	3/4 HP	20 Amp
EDT21	208 / 240	50 / 60	3/4 HP	20 Amp

Defrost Timers



Energy Saving Exact Replacement Defrost Timers



- Exact OEM Features & Specifications
- Energy Saving Plastic Construction
- Available In Bulk (200) or 12 Pack
- Domestic Refrigerators & Freezers

SUPCO Part No. 12/Box	SUPCO Part No. 200/Box	Replaces O.E.M. No.	Cycle Time Hours	Defrost Time Minutes	GP Series	Gem No.
SPA12930 (w/knob)	SPA12930XX	Maytag 10129301 Electrolux 216744400	12	32		
SPA1401AD	SPA1401XX	Admiral 66128-1 Electrolux 215846604	6	21	GP1	CC922
SPB1401F	SPB1401XX	Frigidaire 5300628518 Maytag 68233-2	8	20	GP4	CC925
SPD1401AM	SPD1401XX	Amana D70041-4 Maytag R0131577 Frigidaire 5303321915	8	32	GP19	CC926
SPG1401GE	SPG1401XX	GE WR9X330 Maytag R0168026	6	25	GP2	CC923
SPK1401GE	SPK1401XX	GE WR9X387 Maytag R0168027 Amana D7004119 Amana D7790403	10	30	GP18	CC907
SPM10530 (w/knob)	SPM10530XX	Maytag 10530703	8	21		
SPM6823-3	SPM68233XX	Maytag 68233-3 Amana D7004112 GE WR9X388	10	21	GP9	CC924
SPP1401WE	SPP1401XX	West. 5300900072	6	25	GP3	CC927

* Note for 220 Volt 50 HZ models add "21" to number (examples: SPA140121, SPB140121).
Bulk Pack in 12 pack or 200 pack only.



Flying Lead Timers



- Energy Saving Plastic Construction
- Direct Whirlpool Replacement
- Hardware Kit Included
- Domestic Refrigerators & Freezers

SUPCONo. 12/Box	SUPCONO. 200/Box	Replaces O.E.M. No.	Cycle Time	Defrost Time	GP Series	Gem No.	Mallory No.	Paragon No.	Uni-Line No.
SPA1403FL	SPA1403XX	WHPL 482493; Electrolux 5303917634 Maytag 68233-2 Haier 60938312 Sub-Zero 3081180	8	21	GP4 GP6 GP11 GP21	CC904 CC920 CC309 CC320	34885	E769-00 B931-00	3002-904 UX-2001-00
SPF17633	SPF176XX	WHPL 4391974 Electrolux 5303917633 Maytag 68233-1	6	21	GP1 GP20	CC901, CC922 CC304, CC306 CC311, CC315 CC319	34886 34895	A769-00 E1111-00	3002-901

Defrost Timers

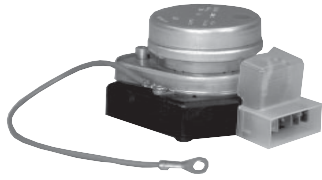

Classic Style Defrost Timers (Metal Top)

- Exact OEM Features & Specifications
- Metal Construction
- Available In 120 or 220 Volts
- Available In Bulk (75) or 12 Pack
- Hardware Kit Included
- Domestic Refrigerators & Freezers

SUPCO No. 12/Box	SUPCO NO. 75/Box	Replaces O.E.M. No.	Cycle Time	Defrost Time	GP Series	Gem No	Mallory No.	Paragon No.	Paragon No.	Uni-Line No.
SP931WP	SP931XX	WHPL 876369 WHPL 482493; Sub-Zero 3081180	8	21	GP11 GP20	CC904 CC920 CC928	34885	E769-00	E931-00	3002-904 UX-2001-00
SPG1111GE	SPG1111XX	GE WR9X330	6	25	GP2	CC900	34887	B769-00	D1111-00	3002-902
SPF1111F	SPF1111XX	Frig. 5300628518	8	20	GP4	CC902	34890	F769-00	A1111-00	3002-906
SPJ1111AM	SPJ1111XX	Amana D700414 Frig 5303321915 GE WR9X396	8	32	GP19	CC905 CC925	34982	D769-00	K1111-00	3002-905
SPL1111W	SPL1111XX	West. 5300900072	6	25	GP3	CC903	34891	G769-00	B1111-00	3002-903
SPN1111AD	SPN1111XX	WHPL 4391974 Admiral 66128-1	6	21	GP1	CC901 CC922	34886	A769-00	E1111-00	3002-901

* Note for 220 Volt 50 HZ models add "21" to number (examples: SP93121, SPG111121, etc.)

Universal Energy Saving Defrost Timers

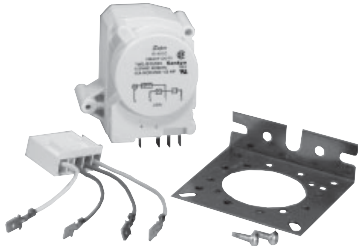

- Universal Design Replaces Most OEM Timers
- Eight Timers Available
- Reduces Inventory
- Energy Saving Plastic Construction
- Complete Hardware Kits , Mounting Plate & Instructions Included
- Quiet Operation
- Dust Proof
- Oil Reservoir
- Oilite Bearing
- No Ground Wire Required
- 120 Volts
- 15 Amp Capacity
- UL Recognized
- CSA Certified
- Domestic Refrigerators & Freezers

SUPCO No.	Replaces O.E.M. No.	Cycle Time	Defrost Time	Uni-Line No.
SC801	WHPL 4210579 Electrolux 216744400 Maytag R0168028	12	32	3002-801
SC802*	WHPL 482493; Electrolux 5303917634 Maytag 68233-2 Sub-Zero 3081180	8	21	3002-802
SC803	Amana D7004111	8	28	3002-803
SC804*	Whirlpool 2183400	8	21	3002-804
SC806	Amana D7004106	6	25	3002-806
SC807**	West. 5300900072	6	25	3002-807
SC808	Electrolux 215846604	6	21	3002-808

* Flying lead may be wired as cumulative run time

** Westinghouse Special - timer motor wired to terminals 2 & 4

Defrost Timers



SA1005 Defrost Timer

- Allows normal refrigerator defrost operation when icemaker is removed from system.
- Direct "plug-in" fit with either suction cup or permanent screw-mounting.
- Fits All Whirlpool & Sears Refrigerators with Flexible Tray Icemakers

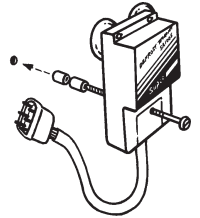



Exact Replacement Evaporator Motors

Electrolux			
5300158289 SM336	5301135914 SM332	5301137820 SM333	5303917278 SM378
Electrolux		General Electric	
5303918015 SM316	5306599389 SM319	WR60X162 SM338	WR60X190 SM344
Reference: 5306599388			
General Electric		Maytag	
WR60X203 SM391	WR60X5073 SM305	55394-7 SM334	56488-2 SM335
Reference: WR60X191			

Part numbers and illustrations are intended solely for identification.
Items offered for sale are not represented to be manufactured by the company that built the original model.

Exact Replacement Evaporator Motors

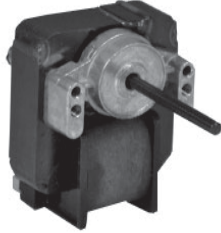
Maytag

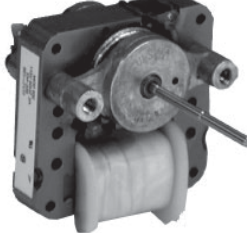
<p>69106-2 SM362</p>	<p>C8713101 SM337</p>	<p>C8891605 SM365</p>	<p>D7241412 SM339</p>
			

Whirlpool

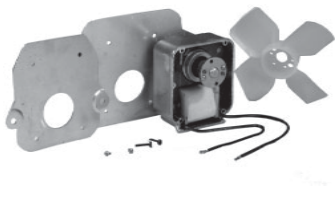
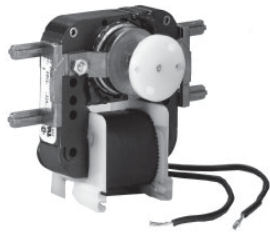
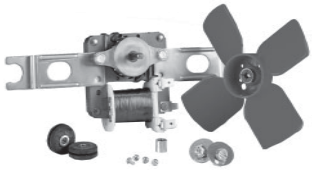
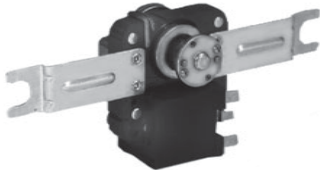
<p>482468 SM327</p>	<p>482469 SM328</p>	<p>482731 SM343</p>	<p>1105609 SM342</p>
 <p>Original Howard Style</p>	 <p>Original Howard Style</p>		

Whirlpool

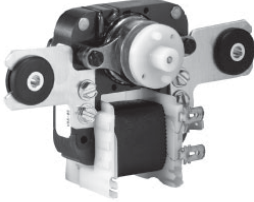
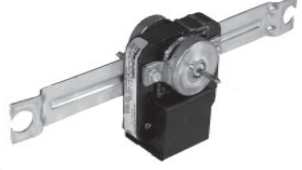
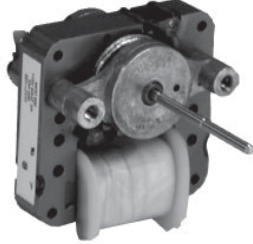
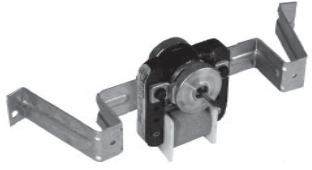
<p>4318001 SM329</p>	<p>4389142 SM345</p>	<p>4389144 SM399</p>	<p>4389145 SM346</p>
 <p>Original Howard Style</p>			

SM motors maximum operating temperature 180°F; Minimum -30°F

Part numbers and illustrations are intended solely for identification.
Items offered for sale are not represented to be manufactured by the company that built the original model.

Evaporator Motors Cross Reference

Electrolux		Electrolux (Cont.)		General Electric (Cont.)		Maytag (Cont.)		Whirlpool (Cont.)	
OEM No.	SUPCO No.	OEM No.	SUPCO No.	OEM No.	SUPCO No.	OEM No.	SUPCO No.	OEM No.	SUPCO No.
00620365	SM316	5303917278	SM378	WR60X182	SM344	C3680601	SM337	937276	SM328
00620962	SM316	5303917473	SM336	WR60X189	SM344	C3684001	SM337	938117	SM343
00621891	SM316	5303918015	SM316	WR60X190	SM344	C8713101	SM337	938124	SM328
00622462	SM316	5306599388	SM316	WR60X191	SM391	C8891601	SM365	938149	SM343
00622852	SM316	5306599389	SM316	WR60X197	SM391	C8891605	SM365	938223	SM328
00623048	SM316	56488-3	SM334	WR60X203	SM391	C8891606	SM365	938283	SM328
00623319	SM316	56488-4	SM334	WR60X5005	SM338	D7241409	SM339	938287	SM343
00625094	SM316	G000158289	SM336	WR60X5011	SM305	D7241412	SM339	938292	SM343
00627286	SM316	G000168579	SM336	WR60X5016	SM305	M0307601	SM337	938296	SM343
00627289	SM316	G000173301	SM336	WR60X5020	SM305	RA43990-1	SM335	938372	SM328
00627293	SM316	G158289	SM336	WR60X5021	SM305			941506	SM328
00627414	SM333	G162705	SM336	WR60X5035	SM305			941547	SM343
00627879	SM332	G163939	SM336	WR60X5040	SM305			941578	SM328
00628530	SM316	G165335	SM336	WR60X5047	SM305			941601	SM328
00628531	SM316	G168579	SM336	WR60X5048	SM305			941687	SM328
00629966	SM316	G168797	SM336	WR60X5049	SM305			945523	SM328
00629968	SM316	G173301	SM336	WR60X5053	SM338			946653	SM343
01135442	SM332	G176117	SM336	WR60X5054	SM305			978212	SM328
01135914	SM332	G178481	SM336	WR60X5057	SM305			987369	SM328
01137820	SM333	K1204667	SM336	WR60X5064	SM305			989608	SM328
06598507	SM316			WR60X5066	SM305			989687	SM343
06599014	SM316			WR60X5073	SM305			992919	SM328
06599015	SM316			WR60X5074	SM305			1100473	SM343
06599388	SM316							1100474	SM343
06599389	SM316							1100945	SM328
07515434	SM316							1100992	SM343
07516457	SM316							1105608	SM343
07544495	SM316							1105609	SM343
07546181	SM316							1107711	SM328
07546735	SM316							1107715	SM328
08000036	SM336							1108111	SM328
08004176	SM336							1118715	SM328
215213300	SM378							2149299	SM399
215314700	SM336							2154419	SM343
215348100	SM378							2154977	SM343
215348200	SM336							2162404	SM399
215360800	SM336							2163766	SM345
215464000	SM336							2166013	SM346
215464100	SM336							2169116	SM343
218322200	SM336							2169143	SM343
218394100	SM378							2169485	SM346
218661700	SM336							2176298	SM345
218718402	SM378							2183448	SM345
218718403	SM336							2183833	SM345
218878700	SM336							2188303	SM399
218878701	SM336							2200546	SM345
218878901	SM336							2205138	SM345
3001224	SM336							4318001	SM343
3001421	SM336							4318002	SM328
3202115	SM334							4389140	SM343
5300158289	SM336							4389141	SM328
5301135442	SM332							4389142	SM345
5301135914	SM332							4389144	SM399
5301137820	SM333							4389145	SM346
5303275816	SM336							8537621	SM343
5303310100	SM336							9791620	SM346
5303917277	SM336								

Evaporator Fan Motors

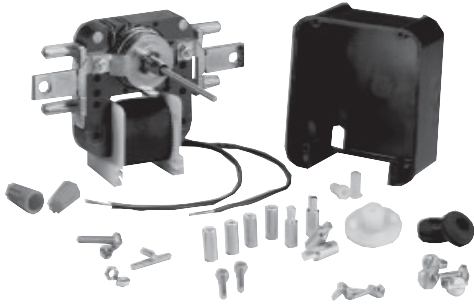

SM999 Universal Evaporator Fan Motor Kit – 120 VAC

- Prefastened Multi Fit, Break Off Mounting Bracket
- Break Off 2" Motor Shaft with Breakaways at 1/2" and 1-1/2"
- Includes All Mounting Accessories and Hardware
- Reversible Rotation
- Single Speed
- Shaft Diameter 1/8"
- Replaces Over 450 Different Evaporator Type Motors.
- Direct Replacement For The GEM 240 Series, Mars 90999 and Robertshaw 33-110, 33-112 & 33-114.



SM998 Universal Evaporator Fan Motor Kit – 220 VAC

- Includes the same Features / Benefits, Applications and Specifications as the SM999, except it operates on 220 VAC 50/60 Hz.
- Direct Replacement for the Mars 90998

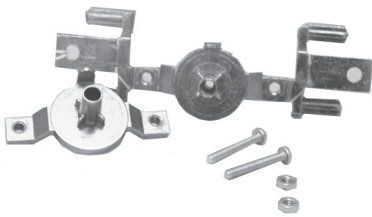

SM999BRKT

SM999/SM998 Kit Replacement Motor Bracket

Part No.	Description
SM999	120 VAC, 3000 RPM, 1/200 H.P., .31 AMP impedance protected
SM998	220 VAC, 3000 RPM, 1/200 H.P., .31 AMP impedance protected

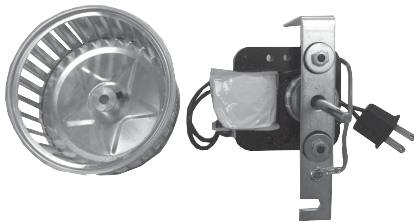

SM140-40A Blower Fan Assembly

- Direct replacement kit for Nutone bath fans
- Replaces Nutone motor p/n K5895 and kit p/n K5894
- Kit includes single speed motor, 3-3/4"x2" blower wheel and mounting bracket.
- Motor includes 6" wire leads with molded plug.

Part No.	Speed	RPM	Volts	AMPS	Rotation	Nutone
SM140-40A	1	2400	115	0.9	CCWSE	K5894 Motor Kit K5895 Motor Only

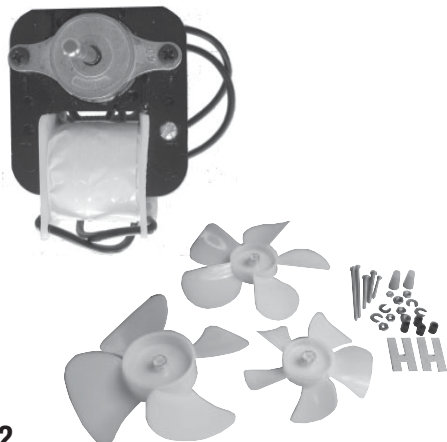

SM6700B Motor Kit Assembly

- Replaces Acme Miami 700
- OEM replacement for Bohn, Heatcraft, Uppco, Singer, GE 33 Series.
- Kit includes reversible motor, three fan blades, hardware kit and Instructions.
- Commercial refrigeration evaporators

Volts	Hertz	AMPS	RPM	Shaft Size	Stack Size	Bearing Type
120	60	.55	3000	3/16" x 1 1/4"	5/8"	Sleeve

SM6700B Replacement Fan Blades 3/16" Hub

FB402	4", CW, 5 wing
FB455 (Bohn 5101B)	5-9/16", CCW, 5 wing
FB550	5 1/2", CCW, 4 wing

SM999 Cross Reference

Acme Miami	Electrolux	Electrolux	Electrolux	Electrolux	GEMLINE	G.E. Mfg.
400	06598501	146620	9956921	G163865	EM309	5KSB44QS1128B
500	06598503	152646	9956922	G163939	EM310	5KSB44QS1129A
600	06598504	163865	9956924	G165335	EM311	5KSB44QSE058A
700	06598506	215213300	9956925	G168579	EM312	G.E. Appl.
800	06598507	215314700	C000028542	G168797	EM313	WR49X169
Electrolux	06599014	215348100	C000028543	G173301	EM314	WR49X5039
00598467	06599015	215348200	C000028545	G176117	EM315	WR49X5040
00620365	06599016	215360800	C000028546	G178481	EM316	WR49X5082
00620635	06599017	215464000	C000028748	G98291	EM317	WR49X5091
00620929	06599388	215464100	C000028751	K1159624	EM318	WR49X5097
00620962	06599389	216737700	C000038088	K1159782	EM319	WR60X100
00621086	06599390	218322200	C000038089	K1159808	EM320	WR60X104
00621891	06599391	218394100	C000038090	K1166476	EM321	WR60X105
00622462	07512280	218661700	C000038785	K1166681	EM322	WR60X108
00622852	07514087	218718402	C000038788	K1166971	EM323	WR60X112
00622892	07515415	218718403	C000038791	K1167246	EM324	WR60X116
00622937	07515434	218878700	C000048400	K1202158	EM325	WR60X118
00623048	07515803	218878701	C000048401	K1202159	EM327	WR60X119
00623319	07516385	218878901	C000048507	K1204665	EM328	WR60X120
00623686	07516386	2660D62H03	C000048579	K1204667	EM329	WR60X122
00625094	07516457	51141	C000048580	K1205028	EM330	WR60X125
00625647	07517873	5300158289	C000048581	K1206352	EM331	WR60X126
00627283	07543975	5300715414	C000057230	K1206353	EM332	WR60X127
00627284	07544495	5301135442	C000289296	K1206354	EM333	WR60X129
00627286	07546181	5301135914	C000289298	K1206452	EM334	WR60X130
00627289	07546735	5301137820	C000289448	K1206453	EM335	WR60X131
00627293	08000036	5303275816	C000460752	K1208099	EM336	WR60X132
00627414	08004176	5303310100	C000715414	K1209560	EM337	WR60X160
00627879	101493	5303917277	C48507	K1220352	EM338	WR60X162
00628524	104076	5303917278	F116267	K1222931	EM339	WR60X163
00628527	110968	5303917473	F58835	K1222932	F58835	WR60X168
00628530	1135442	5303918015	F82388	K1226505	G.E. Mfg.	WR60X171
00628531	1135914	5304442620	F88130	K1226507	5KSB33AS1101	WR60X172
00629965	1137820	5306599388	F88162	K1227015	5KSB33AS1104	WR60X175
00629966	1159624	5306599389	F96740	K1227017	5KSB33AS1105	WR60X178
00629968	1159782	56488-3	G000152646	K1228883	5KSB33AS1787	WR60X181
01135442	1159808	56488-4	G000158289	K1230532	5KSB33AS458B	WR60X182
01135914	116267	58835	G000168579	Gemline	5KSB33AS500	WR60X188
01137820	1166476	5903130	G000173301	EM241	5KSB33AS641	WR60X189
03001224	1202158	59176	G101493	EM242	5KSB33AS677	WR60X190
03001421	1202159	59471	G104076	EM244	5KSB33AS734	WR60X191
03202115	1204665	80719	G104372	EM245	5KSB33BS1613A	WR60X197
06540267	1204667	82169	G109216	EM247	5KSB33BS1913	WR60X203
06540268	1205028	82388	G110968	EM248	5KSB33BS1953	WR60X50
06582708	1206353	827286	G127816	EM249	5KSB33BS3015	WR60X5005
06583827	1206354	83288	G134639	EM300	5KSB33BS3015A	WR60X5006
06584668	1206452	84493	G137417	EM301	5KSB33BSE157	WR60X5009
06596499	1208099	85082	G139044	EM302	5KSB44BS0001	WR60X5010
06598256	1220352	87773	G139046	EM303	5KSB44BS0001F	WR60X5011
06598257	1222931	88130	G143259	EM304	5KSB44BS1033	WR60X5012
06598258	1222932	88138	G146620	EM305	5KSB44BS1091	WR60X5013
06598259	1226505	88162	G152646	EM306	5KSB44BS1104	WR60X5016
06598468	126119	94606	G158289	EM307	5KSB44BSE049	WR60X5019
06598499	127816	96740	G162705	EM308	5KSB44BSE054	WR60X5020

SM999 Cross Reference

G.E. Appl.	Maytag	Maytag	Maytag	Maytag	Whirlpool	Whirlpool
WR60X5021	26999	61005387	C36811-1	D7464901	2197443	548942
WR60X5022	27779	61005592	C3684001	D7464902	2200546	549098
WR60X5023	27842	627414	C36840-1	D7464903	2201212	549212
WR60X5024	28512	627879	C3689301	D74649-3	2201213	549420
WR60X5035	28513	67001509	C3689302	M0302001	2203829	552171
WR60X5040	28515	67003636	C36893-1	M0302002	2205138	566092
WR60X5046	29425-3	69106-1	C36893-2	M0303501	2214986	607058
WR60X5047	29708	69106-2	C3690101	M0303502	2219660	631648
WR60X5048	29708-1	69106-4	C3690102	M0303504	2221893	755182
WR60X5049	52121-1	78756-1	C3690103	M0303599	4318001	756048
WR60X5052	52837-1	A448-1	C36901-1	M0307601	4318002	8112
WR60X5053	52837-2	B4850-1	C36901-2	M3020-1	4389140	8116
WR60X5054	53000-1	B4850-2	C36901-3	M3020-2	4389141	833752
WR60X5057	53001-1	B5546-1	C48400	M3035-1	4389142	833768
WR60X5060	53003	B5546-4	C48507	M3035-2	4389144	850144
WR60X5064	53003-1	B5614-1	C87131	M3035-4	4389145	851170
WR60X5066	53706-1	B5640-1	C8713101	M3076-1	4389146	8537621
WR60X5068	53706-2	C25759-9	C87131-1	R0151001	4389147	936162
WR60X5073	53765-1	C282296	C8891601	R0151002	480639	936163
WR60X5074	53765-3	C303599	C8891605	R0151003	482415	936164
WR60X52	53765-6	C352561	C8891606	R0151004	482468	937276
WR60X54	53765-8	C35256-1	D7115701	R0151005	482469	938117
WR60X57	53767-1	C352567	D7115702	R0151006	482470	938124
WR60X60	54482-1	C35256-7	D7115703	R0151007	482729	938149
WR60X65	54482-10	C352582	D7115704	R0157068	482731	938223
WR60X66	54482-11	C3536301	D7115706	R0157087	482733	938283
WR60X69	54482-2	C3536307	D7115707	RA43990-1	483051	938287
WR60X71	54482-3	C35363-1	D71157-1	RA95052-1	510331	938292
WR60X74	54482-4	C35363-7	D71157-2	Whirlpool	515235	938296
WR60X82	54482-5	C3565601	D71157-3	1100473	515472	938372
WR60X84	54482-7	C3565605	D71157-4	1100474	517441	941506
WR60X85	54482-8	C35656-1	D71157-6	1100945	517472	941547
WR60X88	54482-9	C35656-5	D71157-7	1100992	517474	941578
WR60X90	55394-1	C35656-6	D7241401	1105608	519218	941601
WR60X96	553942	C35657-1	D7241402	1105609	520024	941687
Maytag	55394-2	C3575901	D7241403	1107711	530314	945523
0054159	55394-3	C3575905	D7241404	1107715	530380	946653
0054171	55394-5	C3575906	D7241406	1108111	530452	978212
0055546	55394-7	C3575907	D7241407	1118715	530675	9791620
045563-01	55394-8	C3575909	D7241409	2149299	530763	987369
10449504	55735-1	C35759-1	D7241410	2154419	531645	989608
10449508	55735-10	C3575910	D7241411	2154977	531646	989687
10513801	55735-11	C35759-10	D7241412	2162404	531647	992919
10513802	55735-8	C35759-5	D7241413	2163766	531648	
10513803	55735-9	C35759-6	D7241415	2166013	531826	
10513804	56488-1	C35759-7	D72414-4	2169116	531885	
10654201	56488-2	C35759-9	D72414-9	2169143	542954	
10654202	56488-3	C3587501	D7256201	2169485	547409	
10654205	56488-4	C3680402	D7256202	2176298	547948	
1135914	56488-5	C3680601	D7256203	2183448	547956	
12044801	61001939	C3680602	D72562-1	2183833	547958	
23265	61002107	C36806-1	D72562-2	2188303	548042	
23464	61003008	C36806-2	D72562-3	2188357	548262	
24401	61004888	C3681101	D7289701	2197381	548697	

Motors

Exact Replacement & Utility Motors



SM600 Series Utility Motor Kits

- Versatile replacement for all "C" Frame and "3 1/2" Round Style motors
- Impedance Protected
- SM670, SM672 and SM673 include fan blades FB402 and FB550
- SM675 is Thermal protection
- Available in sleeve or ball bearing design
- SM675 includes fan blade FB550 only
- Motor Kits include complete hardware and mounting kits
- Reach In Cooler & Freezer Evaporators
- Walk In Cooler & Freezer Evaporators
- Exhaust Fans
- Ventilator Fans
- Range Hoods
- Electric Unit Heaters
- Forced Air Heaters

Specifications

Part No.	Type	Volts AC	RPM	Current (AMPS)	Shaft Dimensions	Stack Size	Rotation (Reversible)	Acme Miami	Replaces Bohn	Replaces Robertshaw	Replaces MARS
SM670 ^a	Sleeve	120	3000	0.55	3/16" X 1-1/4"	5/8"	CW/CCW	600, 700, 710, 4670		14001	90971
SM671	Sleeve	120	3000	0.55	3/16" X 1-1/4"	5/8"	CW/CCW			14003	
SM672 ^a	Sleeve	240	3000	0.32	3/16" X 1-1/4"	5/8"	CW/CCW	602, 702, 4672		14005	90982
SM673 ^a	Sleeve	120	3000/1550	.55/.34	3/16" X 1-1/4"	5/8"	CW/CCW	4673		14007	
SM674	Sleeve	120	3000	0.55	3/16" X 1-1/4"	5/8"	CW/CCW			14009	
SM675 ^b	Sleeve	120/240	3000	1.0/.50	3/16" X 2-3/8"	1"	CW/CCW	7502		90970	
SM676	Sleeve	120	3000	0.5	3/16" X 1-1/4"	7/8"	CW/CCW	780		14011	
SM677	Sleeve	120	2000	0.33	3/16" X 1-1/2"	5/8"	CW/CCW			14013	
SM678	Sleeve	120	3000	0.55	3/16" X 1-1/2"	1/2"	CW/CCW			14015	
SM679	Sleeve	120	3000	0.5	7/32" X 1-1/2"	5/8"	CW/CCW			14017	
SM680	Sleeve	120	3000	0.9	3/16" X 1-1/2"	1-1/8"	CW/CCW	750		14019	90970
SM681	Sleeve	120	3000/1550	.82/.21	3/16" X 1-3/8"	5/8"	CW/CCW			14021	
SM683	Sleeve	240	3000	0.25	3/16" X 1-1/4"	7/8"	CW/CCW			14025	90970
SM684 ^c	Sleeve	120	3000/1550	.82/.21	7/32" X 2-1/4"	1"	CW/CCW				
SM685 ^d	Sleeve	120	3000/1550	.82/.21	3/16" X 1-3/4"	7/8"	CW				
SM686	Ball Bearing	120	3000	0.41	3/16" X 1-1/4"	5/8"	CW/CCW	BB600, BB700, BB710, BB4670			90948
SM687	Ball Bearing	120/240	3000	1.6/.80	3/16" X 2-3/8"	1-1/8"	CW/CCW	BB7502			
SM688	Ball Bearing	120	3000	0.86	3/16" X 1-1/2"	1-1/8"	CW/CCW	BB750			
SM690C	Sleeve	120	3000	0.4	3/16" X 1-1/2"	5/8"	CW				
SM691	Sleeve	120	3000	.80	3/16" X 1-1/4"	5/8"	CW		5007S 5036F 5018S		
SM692	Sleeve	240	3000	.40	3/16" X 1-1/4"	5/8"	CW		5007T 5018T		
SM775	Sleeve	120/240	3000	1.0/.52	3/16" X 2-3/8"	1"	CW/CCW				

^a Includes hardware kit: 2 fan blades, mounting bracket, hub adapter, 1/4" shaft adapter, & 5/16" shaft adapter.

^b Includes hardware kit: 1 fan blade, mounting bracket, hub adapter, 1/4" shaft adapter, & 5/16" shaft adapter. Motor shaft is 2-3/8" with breakoffs at 5/8" & 1-7/8" points.

^c Direct replacement for Gaffers & Sattler, Dyna Vent and others.

^d Direct replacement for GE WB26X24, WB26X40, WB26X45 (D shaft).

Motors

SM550 Series Ventilator Motors

- Exact Replacement for Nutone Range Hood Ventilators
- C Frame Design
- SM550 Motor includes FB460 Impeller
- Range Hoods
- Bathroom Exhaust Fans

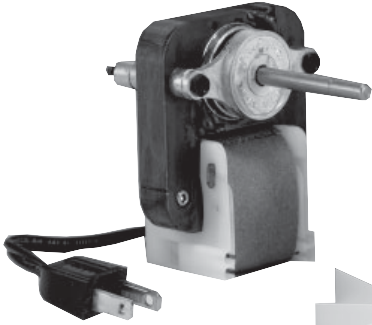

Supco No.	Speed	RPM	Shaft Diameter	Shaft Length	Rotation	Stack	Leads
SM550	1	3000	.217" X .181" flat	1 3/4"	CCWSE	1/2"	120 V Plug
SM551*	2	High 3000 Low 1640	.217" X .187" flat	1 7/16"	CWSE	7/8"	Molex 3 pin
SM552	1	3000	.217" X .187" flat	1 1/4"	CCWSE	3/4"	120 V Plug
SM553	1	3000	.217" X .187" flat	1 3/4"	CCWSE	3/4"	Eyelet
SM554*	2	High 3000 Low 1640	.217" X .181" flat	1 7/16"	CCWSE	7/8"	Molex 3 pin
SM555	1	3000	.217" X .187" flat	2 3/8"	CCWSE	5/8"	120 V Plug
SM140-40A	1	1400	.217" X .187" flat	2 3/8"	CCWSE	5/8"	120 V Plug
SM556	1	3000	.181" X .148" flat	1 7/8"	CCWSE	5/8"	120 V Plug

Supco No.	Gem No.	Old Nutone No.	Current Nutone	Type	Application	Model Notes	Robertshaw	Packard	Fasco
SM550	EM550/ EM750	C65878	65878000	Universal	Nutone Broan Vent Hood or Bath Vent	Universal, includes FB460 fan blade.	33-100/ VFM100	6510	K111
SM551	EM551/ EM751	C52367	52637000	Range	Vent Motor	Used on M1 through M9 series, common to many brands	33-101/ VFM101	65101	K112
SM552	EM552	C63675	63675000	Bath	Vent Motor	Used on 9415 series, 9425 series and others	33-103/ VFM103	65103	K113
SM553	EM553	C66582	66582000	Bath	Heater Motor	Used on 9415 series, 9425 series and others	33-104/ VFM104	65104	K115
SM554	EM554	C27987	27987000	Range	Vent Motor	Used on M9T & VM9T, common to many brands	33-105/ VFM105	65105	N/A
SM555	EM555 K5895	C68627	68627000	Bath	Vent Motor	Used on 9415 series, 9425 series and others	33-106/ VFM106	65106	K109
SM140-40A	N/A	C68626 C68627 K5894 Kit K5895 Motor	68626000	Vent Assembly	Motor, Bracket, & Blade	Used on 9415 series, 9425 series and others	N/A	N/A	N/A
SM556	EM556	C34484	34484000	Range	Vent Motor	Nutone & Broan 40000 series except for 40000H	N/A	N/A	N/A

Motors

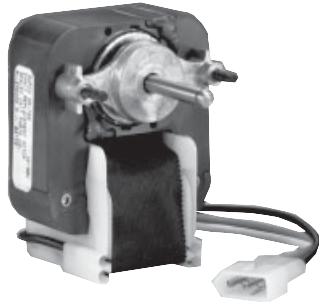

SM700 Series Ventilator Motors

- Exact Replacement for Broan Ventilators
- C Frame Design
- 120 Volts / 60 Hz
- CCW Rotation
- Multi Fit To Work With Other Brand Ventilators



Supco No.	Shaft Speed	Shaft Diameter	Shaft Length	Stack	Leads	No.	Broan Type	Model Notes
SM700	2	7/32" w/flat	1 1/4"	3/4"	3 Pin	99080218	Range	Used on Economy Models
SM701	1	1/4" w/flat	2 3/4"	7/8"	2 Prong	99080159	Bath Heater	Used on 162 C & D- replace 9908145 if you reverse the rotation - Model 162B
SM702	1	1/4" w/flat	1 3/4"	7/8"	5 Pin	99080160	Bath Heater	Used on 160B series, 164 series (replace 99080146 if you reverse rotation for 164B & 160A series)
SM703	1	5/32" w/flat	1 1/4"	1/2"	2 Prong	99080245	Bath Heater	Used on 688 D - can
SM704	1	7/32" w/flat	1 1/2"	7/8"	2 Prong	99080166	Multiple 1973 to 2006	Used on 655 series, 657 series, 658 series, 679 series, 740 series, 741 series & others
SM705	1	.181" w/flat	1 7/8"	5/8"	2 Prong	99080216	Range	Broan 40000 series except for 40000H

* Prior to 1978 a smaller shaft was used on the 99080166, if shaft is not 7/32" order fan blade as well.

Tech Tip:

- "F" suffix on shaft length indicates flat on shaft.
- "S" suffix indicates spline shaft.
- When replacing a motor make sure that the type, voltage, amperage, wattage, rotation, shaft size, stack size and the electrical connectors are the same as the original motor.

Motor Rotation as viewed facing Shaft
 CW - Clockwise Rotation
 CCW - Counter Clockwise

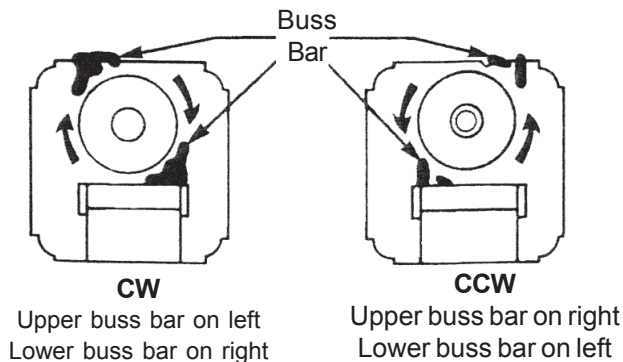

Motor Rotation

To determine motor rotation:
 CW - Clockwise CCW - Counter Clockwise

- Facing shaft end of motor, locate the copper Buss Bar as indicated in illustration.
- The Buss Bar location determines shaft rotation.

Fan Blades

Exact Replacement Plastic Impellers



- Broan & Nutone Exact Replacement Impellers
- 3 Sizes Available
- Bathroom Ventilators
- Kitchen Ventilators

Tech Tip

- “F” Suffix on impeller hole indicates impeller will accommodate flat shaft.

PART NO.	REPLACES MFG. NO.	BLADE O.D.	HOLE I.D.
SB001	Nutone 68920	4 5/8"	.181F
FB460	Broan 9910379H	4 9/16"	.218F
FB461	Broan 99110630	4 5/8"	.150

Plastic Blower Wheels



- 3 Sizes Available
- Bathroom Ventilators
- Kitchen Ventilators

PART NO.	SHAFT	ROTATION	BOTTOM DIAMETER	DEPTH	TOP DIAMETER	OEM PART NO.
FB250	1/8"	CW	2 1/2"	1"	2 11/16"	
FB325	3/16"	CW	3"	1"	3 1/4"	
FB590	1/4"	CW	5 3/4"	2"	6 1/8"	Nutone 59000A

Plastic Vent Hood Fan Blades

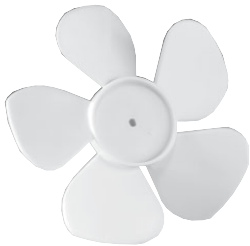

- 2 Sizes Available
- Ducted & Non Ducted Vent Hoods

PART NO.	SHAFT	DIAMETER	NO. BLADES	ROTATION	PITCH	VOLUME
FB660	7/32" w/flat	6 5/8"	5	CW	25°	High
FB665	7/32" w/flat	6 5/8"	5	CW	12°	Standard

Use with SM500 series or SM700 series that have 7/32" w/flat shaft.
Replaces Nutone 68929300 and many Broan blades

Plastic Fan Blades – General Purpose



- Celcon Plastic Construction
- Light Weight Design Reduces Bearing Wear & Vibrations
- 2-1/2" to 8" Diameter Sizes Available (1/2" increments)
- Integral Hub Available In 1/8", 3/16", 1/4" & 5/16" Sizes
- Color Coded Rotation White = CW Gray = CCW
- Eliminates Bent or Misaligned Blades
- Low Air Noise
- Refrigerator & Freezer Evaporators
- Ventilators



PART NO.	SHAFT	DIAMETER	NO. OF BLADES	ROTATION	PART NO.	SHAFT	DIAMETER	NO. OF BLADES	ROTATION	PART NO.	SHAFT	DIAMETER	NO. OF BLADES	ROTATION
FB299	3/16"	2 1/2"	4	CW	FB503	5/16"	5"	5	CW	FB650	3/16"	6 1/2"	5	CW
FB300	1/8"	3"	4	CW	FB504	3/16"	5"	5	CCW	FB651	1/4"	6 1/2"	5	CW
FB301	3/16"	3"	4	CW	FB505	1/4"	5"	5	CCW	FB652	5/16"	6 1/2"	5	CW
FB302	3/16"	3 1/2"	4	CCW	FB506	5/16"	5"	5	CCW	FB701	1/4"	7"	5	CW
FB350	3/16"	3 1/2"	4	CW	FB550	3/16"	5 1/2"	4	CCW	FB702	5/16"	7"	5	CW
FB401	1/8"	4"	5	CW	FB551	1/4"	5 1/2"	4	CCW	FB703	1/4"	7"	5	CCW
FB402	3/16"	4"	5	CW	FB601	3/16"	6"	6	CW	FB704	5/16"	7"	5	CCW
FB403	1/8"	4"	5	CCW	FB602	1/4"	6"	4	CW	FB801	1/4"	8"	5	CW
FB404	3/16"	4"	5	CCW	FB603	5/16"	6"	4	CW	FB802	5/16"	8"	5	CW
FB406	1/8"	4"	4	CW	FB604	3/16"	6"	4	CCW	FB803	1/4"	8"	5	CCW
FB501	3/16"	5"	5	CW	FB605	1/4"	6"	4	CCW	FB804	5/16"	8"	5	CCW
FB502	1/4"	5"	5	CW	FB606	5/16"	6"	4	CCW					

Fan Blades

Aluminum Fan Blades - General Purpose

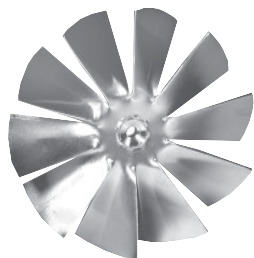

Tech Tip

- Rotation is determined by facing air discharge

- 22 Gauge Aluminum Alloy Construction
- Light Weight Design Reduces Bearing Wear & Vibration
- 4" to 6 1/2" Diameter Sizes Available (1/2" increments)
- Slotted Set Screw Hub Sizes 3/16", 7/32" & 1/4"

- Clockwise or Counter Clockwise Rotations
- Refrigerator & Freezer Evaporators
- Ventilators

PART NO.	SHAFT	DIAMETER	NO. BLADES	ROTATION	PITCH	PART NO.	SHAFT	DIAMETER	NO. BLADES	ROTATION	PITCH
FB150	3/16"	4"	10	CW	35	FB172	1/4"	5 1/2"	4	CW	22
FB151	1/4"	4"	10	CW	35	FB173	3/16"	5 1/2"	4	CCW	22
FB152	3/16"	4"	10	CCW	35	FB174	7/32"	5 1/2"	4	CCW	22
FB153	1/4"	4"	10	CCW	35	FB175	1/4"	5 1/2"	4	CCW	22
FB156	3/16"	4 1/2"	10	CW	40	FB178	3/16"	6"	4	CW	20
FB157	1/4"	4 1/2"	10	CW	40	FB179	7/32"	6"	4	CW	20
FB158	3/16"	4 1/2"	10	CCW	40	FB180	1/4"	6"	4	CW	20
FB159	1/4"	4 1/2"	10	CCW	40	FB181	3/16"	6"	4	CCW	20
FB162	3/16"	5"	4	CW	19	FB182	7/32"	6"	4	CCW	20
FB163	7/32"	5"	4	CW	19	FB183	1/4"	6"	4	CCW	20
FB164	1/4"	5"	4	CW	19	FB186	3/16"	6 1/2"	4	CW	20
FB165	3/16"	5"	4	CCW	19	FB187	7/32"	6 1/2"	4	CW	20
FB166	7/32"	5"	4	CCW	19	FB188	1/4"	6 1/2"	4	CW	20
FB167	1/4"	5"	4	CCW	19	FB189	3/16"	6 1/2"	4	CCW	20
FB170	3/16"	5 1/2"	4	CW	22	FB190	7/32"	6 1/2"	4	CCW	20
FB171	7/32"	5 1/2"	4	CW	22	FB191	1/4"	6 1/2"	4	CCW	20

Plastic Fan Blades Direct Replacement and Hub Type

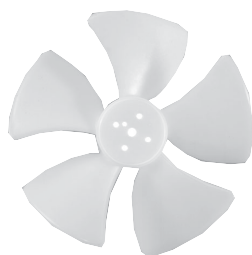

- Eight Popular Direct Replacements
- Available in Hub or Shaft Mount 1/8", 3/16"
- Clockwise & Counter Clockwise Rotations
- Refrigerator & Freezer Evaporators

PART NO.	SHAFT	DIAMETER	NO. BLADES	ROTATION	REPLACEMENT FOR
FB351	HUB	4"	5	CW	Universal Appl
FB352	HUB	4"	5	CCW	Universal Appl
FB353	HUB	4"	4	CCW	Whpl/Cldspt 513543
FB450	1/8"	4 1/2"	5	CCW	GE WR60X114
FB455	3/16"	5 9/16"	5	CCW	Bohn 5101B
FB456	1/8"	5 9/16"	5	CCW	Bohn 5036F,5007S,5018S
FB457	1/8"	4"	4	CCW	Whirlpool/482731
FB718	HUB	7"	5	CW	Admiral 62934-2, 69958-1
FB718G	HUB	7"	5	CW	GEM FB718 SubZero 3-15-032-0

Aluminum Condenser Fan Blades

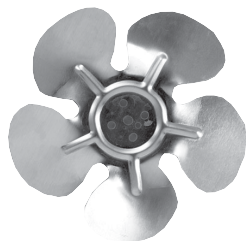

- Aluminum Construction
- 9 Popular Sizes Available
- 6" to 10" Diameter
- Clockwise & Counter Clockwise Rotations
- 5 Blades
- Unit Bearing Motors with 1/4" x 20 Threaded Shafts

PART NO.	DIAMETER	NO. OF BLADES	ROTATION	PITCH
FB101	6"	5	CW	-
FB102	6"	5	CCW	-
FB103	7"	5	CCW	20°
FB104	7"	5	CW	20°
FB105	8"	5	CCW	20°
FB106	8"	5	CW	20°
FB107	8 3/4"	5	CW	20°
FB108	10"	5	CCW	29°
FB109	10"	5	CW	22°

Tech Tip

Fan Blade Rotation To determine the blade rotation.
CW- Clockwise & CCW -Counter Clockwise

1. Lay blade on a flat surface (either side up).
2. The direction of rotation is determined by observing which blade edge touches the flat surface.
3. Left side is touching the flat surface = CW.
4. Right side is touching the flat surface = CCW.

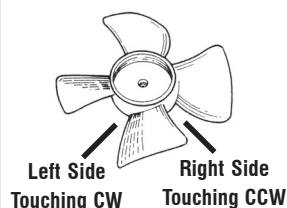

Icemakers

Mechanical Style Icemakers

Each Kit Features:

- Complete harness for direct replacement
- Includes mounting hardware
- Installs easily using existing harness or provided harness
- Water fill adjustment to compensate for varying water pressure
- Each unit has automatic and manual shut-off feature
- Thermal safety cut-out prevents mold element overheating
- Eight cavity mold forms crescent shaped cubes
- Multi-position water inlet from side, rear, or top fill

Optimize Ice Production

- Set freezer to below 10°F
Colder setting, more ice. From 1 lb. to 10 lbs. per 24 hr/day
- Install water filter
For better taste, reduces corrosion in icemaker

Just need a bare icemaker and not the kits? Checkout the RIM116 for the Mechanical style and the RIM900 for the Modular Style.

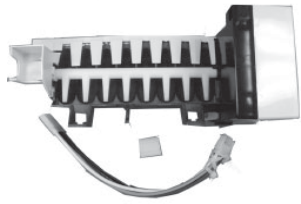

RIM116 Replacement Icemaker

RIM116 is designed as a direct replacement icemaker only. This service unit will plug-in as a direct replacement for the standard mechanical style icemaker. Used in all major brands, also replaces the old Gemline icemakers and Supco's mechanical style icemakers.

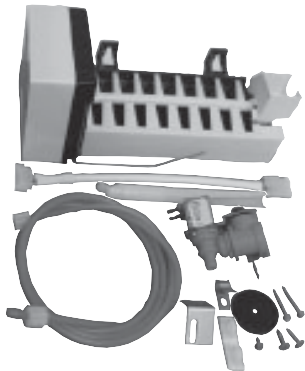

Electrolux RIM115 Icemaker Service Kit

RIM115 was designed to be a direct replacement for the Electrolux IM115 and 218736300 service and prewired installation kits. Kit includes: Icemaker, ice bin, hardware kit, fill line, fill tube, and water valve. Add a WF271 water filter.

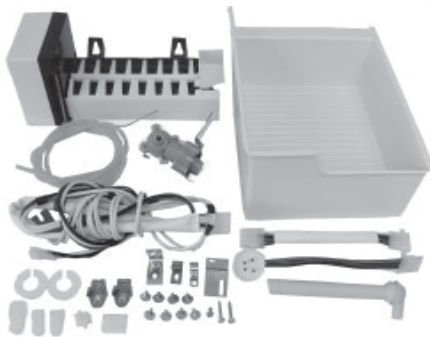

Electrolux RIM400 Icemaker Installation Kit

RIM400 was designed to be a direct replacement for the Electrolux IM34 and 218734400 service and prewired installation kits. Kit includes: Icemaker, ice bin, hardware kit, wiring harness, fill line, fill tube, and water valve. Add a WF271 water filter.

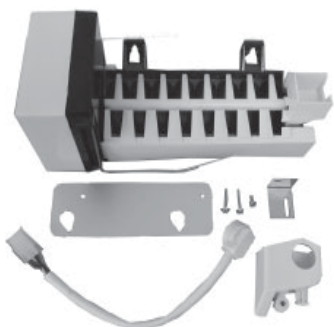

General Electric RIM300 Icemaker Service Kit

RIM300 was designed to be a direct replacement for the General Electric IM1 through IM3 series and the UKKIT series icemakers. This Service unit comes with icemaker, adapter mounting plate, wiring harness and hardware. Excellent service kit for over 75 GE part numbers.

Icemakers

Maytag Flex Tray Icemakers

The RIM655 by Gem Products is not available. However if a replacement icemaker for the RIM655 is needed use the RIM116 and your old hardware/harness. If you are working on an original Admiral flex tray system and need the flex tray Admiral 59688-1 order the Supco GA277.



Maytag RIM117 Replacement Icemaker Kit

RIM117 was designed to replace the Amana IC series mechanical style icemakers. The kit includes: Icemaker, harnesses, and fill tube. Some models used modular head icemakers, see RIM900 for replacing modular head icemakers. See cross reference for specific applications.

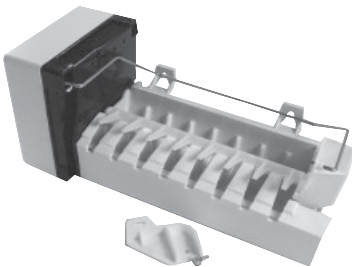

Maytag RIM900 Icemaker Service Kit

RIM900 is a direct replacement for a burnt out modular icemaker. This kit includes: Icemaker and the most popular wiring harness. The old harness can be used. Need just the modular head see IMM8366, need the harvest thermostat see SL7985. See cross reference page for specific applications.



Maytag IMM8366 Icemaker Modular Head

IMM8366 Modular Head is a direct replacement for existing modular head icemakers. Used in Kenmore, Kitchenaid, Maytag, Roper, Sub-Zero, and Whirlpool icemakers. A quick rebuild for an icemaker, see the SL7985 harvest thermostat to finish the job. Replaces Whirlpool 628366, 628519, and Maytag R0156628.

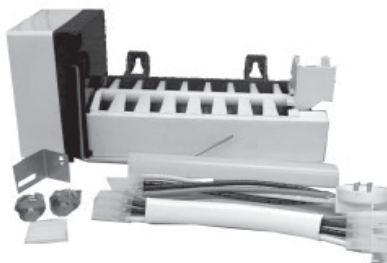

Maytag RIM500 Icemaker Service Kit

Supco's RIM500 was designed to replace the Gemline RIM500 and RIM550. This service unit replaces the mechanical style Admiral/Maytag units. The kit includes: Icemaker, harnesses, and fill tube. Unit also includes harnesses to replace Whirlpool 4317943 and 978556.

Icemakers

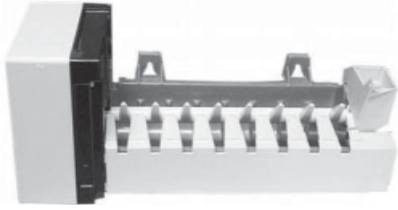

Maytag RIM943 Icemaker Kit

RIM943 Icemaker Kit is designed to replace the modular icemaker service kit. Kit includes icemaker with cover, lever arm, and 4 harnesses. See cross reference page for specific applications.

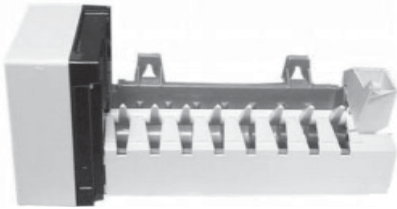

Sub-Zero RIM943 Icemaker Kit

RIM943 Icemaker Kit is designed to replace the modular icemaker service kit. Kit includes icemaker with cover, lever arm, and 4 harnesses. Replaces Sub-Zero 4201760, Use RIM900 or RIM943 for 450520, 420521, or 420522. Replacement Module use IMM8366, Replacement Harvest thermostat use SL7985.



Whirlpool Flex Tray Icemakers

The RIM700 by Gem Products is not available. However if a replacement icemaker for the RIM700 is needed use the RIM116 and your old hardware/harness. If a replacement icemaker cannot be found or is not required by the customer, use SUPCO SA1005 defrost control to make the refrigerator useable without the icemaker function.

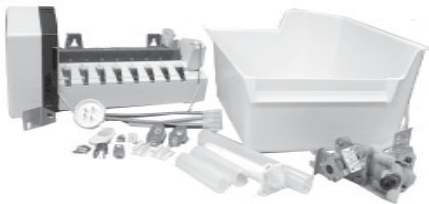

Whirlpool RIM313 Icemaker Installation Kit

RIM313 was designed to replace the Whirlpool 1129313 and ECKMF-64 icemaker installation kits. Kit includes icemaker with cover, lever arm, hardware, wiring harness, water valve, fill tubes, fill line, and ice bin. See cross reference page for specific applications. Add a WF271 water filter.



Whirlpool RIM316 Icemaker Installation Kit

RIM316 was designed to replace the Whirlpool 1129316 and ECKMF-90 icemaker installation kits. Kit includes icemaker with cover, lever arm, hardware, wiring harness, water valve, fill tubes, fill line, and ice bin. See cross reference page for specific applications. Add a WF271 water filter.

Icemakers

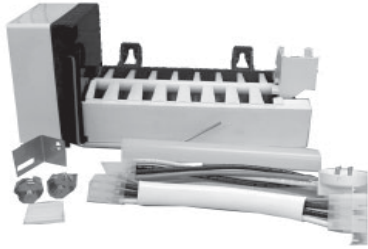

Whirlpool RIM500 Icemaker Service Kit

Supco's RIM500 is a direct replacement for the Whirlpool 978566 mechanical style and the 4317943 modular icemaker. The kit includes: Icemaker, 2 harnesses, and fill tube. This service kit includes 2187464 straight harness and the 7" round hose.

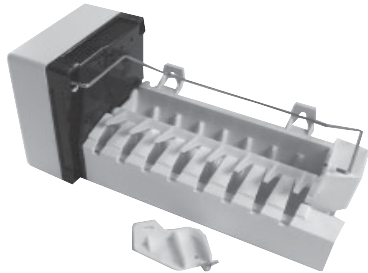

Whirlpool RIM900 Icemaker Service Kit

RIM900 is a direct replacement for a burnt out modular icemaker. This kit includes: Icemaker and the most popular wiring harness. The old harness can be used. Need just the modular head see IMM8366, need the harvest thermostat see SL7985. See cross reference page for specific applications.

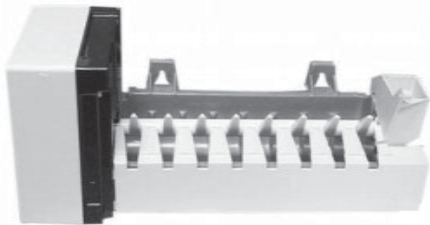

Whirlpool RIM943 Icemaker Kit

RIM943 Icemaker Kit is designed to replace the Whirlpool 4317943 modular icemaker service kit. This direct replacement kit includes icemaker with cover, lever arm, and 4 harnesses. See cross reference page for specific applications.



Whirlpool IMM8366 Icemaker Modular Head

IMM8366 Modular Head is a direct replacement for existing modular head icemakers. Used in Kenmore, Kitchenaid, Maytag, Roper, Sub-Zero, and Whirlpool icemakers. A quick rebuild for an icemaker, see the SL7985 harvest thermostat to finish the job. Replaces Whirlpool 628366, 628519.

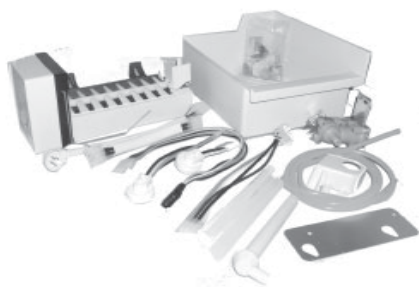

Universal for all Major Brands RIM2000 Icemaker Service Kit

RIM2000 is designed as a universal replacement icemaker kit. This service kit will plug-in as a direct replacement or can be used as a new icemaker for pre-wired refrigerators. Used in all major brands, also replaces the old Gemline icemakers and Supco's mechanical style icemakers. See cross reference for suggested applications.

Icemaker Parts

Direct Replacement Icemaker Harvest Thermostats

These Direct Replacement Icemaker Release Thermostats cycle the icemaker into harvest mode once the ice cubes have released from ice mold. Replacements for mechanical and modular style icemakers.



Style A

Used on New Style Mechanical

Icemaker Harvest Thermostats

Brand	Replaces OEM No.	Exact Supco No.	Open °F	Close °F	Diff. °F	Style
Electrolux	3206322	SL6322	48	15	33	A
GEWR50X22	SL5022	26	16	10	B	
Maytag	625844	SL5844	48	18	30	C
95092-1	SL7985	32	17	15	D	
R0161023	SL5844	48	18	30	C	
R0161036	SL5844	48	18	30	C	
R0161060	SL7985	32	17	15	D	
Sub-Zero	627180	SL5844	48	18	30	C
627985	SL7985	32	17	15	D	
Whirlpool	625844	SL5844	48	18	30	C
627051	SL5844	48	18	30	C	
627180	SL5844	48	18	30	C	
627985	SL7985	32	17	15	D	



Style B

GE Style with Plug



Style C

Used on Old Style Modular



Style D

Used on Current Style Modular



Icemaker Safety Fuse

SL6319 Direct Replacement Safety Fuse for mechanical style icemakers. Used in Electrolux, GE, Haier, and others. Replaces Electrolux 3206319



Icemaker Cycle Switch

ES16802 Replaces the cycling switches in mechanical style icemakers. The ES16802 switch can be used interchangeably for the shut-off switch, water fill switch, or the hold switch. This SPDT microswitch has 3/16" terminals and is widely used in thousands of applications. Electrolux 5303917595, Sub-Zero / Whirlpool 627512

Icemaker Parts



Icemaker Drive Gear

GA31 Drive gear for mechanical style icemakers. Replaces Electrolux 3206301, GE WR29X5162, Maytag R0183094, and Whirlpool 628210



Icemaker Drive Motor (Mechanical Style)

IMM6306 is a direct replacement for current production mechanical style icemakers. Used in Electrolux, GE, Gemline, Haier, Supco Mechanical and most other mechanical style icemakers. This motor retrofits to past models. Electrolux 3206306



Icemaker Drive Motor (Modular Head)

IMM8366 Module Head includes the replacement motor for modular icemakers. Rebuilding, don't forget the SL7985 harvest thermostat.



Icemaker Ice Bin

GA700 is a large replacement ice bin that is a direct replacement for hundreds of OEM bins. A great upgrade for many of the smaller ice bins used in older models. Injection molded white plastic bin is top rack dishwasher safe.

Icemaker Cross Reference

Electrolux Brands			General Electric Brands (Cont)			Maytag Brands (Cont)			Maytag Brands (Cont)		
OEM No.	Style	Supco No.	OEM No.	Style	Supco No.	OEM No.	Style	Supco No.	OEM No.	Style	Supco No.
218226700	MS	RIM116	WR30X186	MS	RIM300	047195-01	MH	RIM900	D7567104	MS	RIM115
218699501	MS	RIM116	WR30X187	MS	RIM300	10549201	MH	RIM900	D7579401	MS	Consider RIM2000
218713500	MS	RIM116	WR30X199	MS	RIM300	10563705	MH	RIM900	D7645001	MS	Consider RIM2000
218734400	MS	RIM400	WR30X203	MS	RIM300	10563705Q	MH	RIM900	D7733001	MS	Consider RIM2000
218736300	MS	RIM115	WR30X209	MS	RIM300	10563707	MH	RIM900	D7733101	MS	Consider RIM2000
21899501	MS	RIM116	WR30X211	MS	RIM300	10563708	MH	RIM900	D7767601	MH	RIM900
240352401	MS	RIM116	WR30X213	MS	RIM300	1110702A	MS	RIM115	D7824701	MH	RIM900
240352403	MS	RIM116	WR30X214	MS	RIM300	116310	MH	RIM900	D7824702	MH	RIM900
240352407	MS	RIM116	WR30X234	MS	RIM300	1165801A	MS	RIM2000	D7824703	MH	RIM900
240352409	MS	RIM116	WR30X237	MS	RIM300	1165807A	MS	RIM115	D7824704	MH	RIM900
240352412	MS	RIM116	WR30X238	MS	RIM300	1170101A	MS	RIM117	D7824705	MH	RIM900
52305-4	MH	RIM900	WR30X239	MS	RIM300	12001294	MH	RIM900	D7824705	MS	RIM2000
5303291912	MS	RIM116	WR30X241	MS	RIM300	12001302	MH	RIM900	D7824705Q	MH	RIM900
5303918277	MS	RIM116	WR30X253	MS	RIM300	12001302	MS	RIM116	D7824706	MH	RIM900
53105-2	MH	RIM900	WR30X253DS	MS	RIM300	12500010	MH	RIM900	D7824706Q	MH	RIM900
IK-4	MS	RIM400	WR30X253R	MS	RIM300	12500011	MH	RIM900	G1KSS	MH	RIM900
IK-7	MS	RIM400	WR30X254	MS	RIM300	12500012	MH	RIM900	G1KTM	MH	RIM900
IK-8	MS	RIM400	WR30X255	MS	RIM300	12500048	MS	RIM2000	HMG-9012	MH	RIM900
IK-9	MS	RIM115	WR30X259	MS	RIM300	1301601A	MS	RIM2000	HMG-9013	MH	RIM900
IM115	MS	RIM115	WR30X280	MS	RIM300	1327001PA	MS	RIM2000	HMG-9018	MH	RIM900
IM34	MS	RIM400	WR30X282	MS	RIM300	52304-1	MH	RIM900	HMG-9020	MH	RIM900
RA-43714-1	MH	RIM900	WR30X282R	MS	RIM300	52305-1	MH	RIM900	IC11B	MH	RIM900
RA-43714-10	MH	RIM900	WR30X283	MS	RIM300	52305-3	MH	RIM900	IC11B	MS	RIM115
RA-43714-11	MH	RIM900	WR30X284	MS	RIM300	52305-6	MH	RIM900	IC2	MH	RIM900
RA-43714-12	MH	RIM900	WR30X289	MS	RIM300	52305-8	MH	RIM900	IC2	MS	RIM117
RA-43714-14	MH	RIM900	WR30X290	MS	RIM300	53105-1	MH	RIM900	IC3	MH	RIM900
RA-43714-2	MH	RIM900	WR30X304	MS	RIM300	53105-2	MH	RIM900	IC3	MS	RIM115
RA-43714-4	MH	RIM900	WR30X304	MS	RIM300	53105-37	MH	RIM900	IC3H	MH	RIM900
RA-43714-6	MH	RIM900	WR30X304R	MS	RIM300	53105-47	MH	RIM900	IC3H	MS	RIM115
RA-43714-8	MH	RIM900	WR30X305	MS	RIM300	53105-7	MH	RIM900	IC3K	MH	RIM900
RA-43714-9	MH	RIM900	WR30X306	MS	RIM300	61005508	MH	RIM900	IC3K	MS	RIM115
General Electric Brands			WR30X307	MS	RIM300	62577-1	MH	RIM900	IC3Q	MH	RIM900
OEM No.	Style	Supco No.	WR30X310	MS	RIM300	62577-11	MH	RIM900	IC3Q	MS	RIM115
M-1	MS	RIM2000	WR30X315	MS	RIM300	62577-13	MH	RIM900	IC4	MH	RIM900
IM1R	MS	RIM2000	WR30X316	MS	RIM300	62577-4	MH	RIM900	IC4	MS	RIM117
IM-2	MS	RIM2000	WR30X318	MS	RIM300	62577-5	MH	RIM900	IC4N	MH	RIM900
IM2R	MS	RIM2000	WR30X320	MS	RIM300	62577-6	MH	RIM900	IC4N	MS	RIM117
IM3	MS	RIM300	WR30X326	MS	RIM300	62577-7	MH	RIM900	IC4Q	MH	RIM943
IM-3	MS	RIM2000	WR30X327	MS	RIM300	65638-1	MH	RIM900	IC4R	MH	RIM900
IM3R	MS	RIM2000	WR30X328	MS	RIM300	67001263	MH	RIM900	IC4R	MS	RIM117
IM-4	MS	RIM2000	WR30X329	MS	RIM300	67001740	MH	RIM900	IC5	MS	Consider RIM2000
IM-6	MS	RIM2000	WR30X330	MS	RIM300	67005153	MH	RIM900	IC52	MS	Consider RIM20
IMG3	MS	RIM300	Gemline			68111-1	MH	RIM900	IC52E	MS	Consider RIM20
JS2	MS	RIM2000	OEM No.	Style	Supco No.	68972-1	MH	RIM900	IC6	MH	RIM900
JS3	MS	RIM2000	RIM1000	MS	RIM2000	68972-4	MH	RIM900	IC6	MS	RIM400
MSE1	MS	RIM2000	RIM200	MS	RIM116	69452302	MH	RIM900	IC7	MH	RIM900
UKKIT1	MS	RIM300	RIM2000	MS	RIM2000	69452310	MH	RIM900	IC7	MS	RIM400
UKKIT2	MS	RIM300	RIM300	MS	RIM300	69452329	MH	RIM900	IC8	MH	RIM900
UKKIT3S	MS	RIM300	RIM313	MS	RIM313	69452337	MH	RIM900	IC8	MS	RIM115
UKKIT4	MS	RIM300	RIM316	MS	RIM316	69463673	MH	RIM900	IC9	MS	Consider RIM2000
UKKIT5	MS	RIM300	RIM321	MS	RIM117	95091-1	MH	RIM900	IC9T	MS	Consider RIM2000
WR29X5144	MS	RIM300	RIM400	MS	RIM400	95098-1	MH	RIM900	IK1ANS	MH	RIM900
WR30M149	MS	RIM300	RIM500	MS	RIM500	95109-1	MH	RIM900	IK1ANT	MH	RIM900
WR30M153	MS	RIM300	RIM550	MS	RIM500	C3641505	MS	RIM2000	IK1FNS	MH	RIM900
WR30X112	MS	RIM300	RIM650	MS	RIM117	C3641510	MS	RIM2000	IK1FNT	MH	RIM900
WR30X129	MS	RIM300	Maytag Brands			CIKHTM-1V	MH	RIM900	IK1HNS	MH	RIM900
WR30X134	MS	RIM300	OEM No.	Style	Supco No.	CK177TM	MH	RIM900	IK1HNT	MH	RIM900
0054450	MS	RIM116	0054450	MS	RIM116	CK277SS-1V	MH	RIM900	IK76DP	MH	RIM900
WR30X138	MS	RIM300	0054498	MS	RIM115	D7036801	MS	RIM2000	IK76DP-1	MH	RIM900
WR30X141	MS	RIM300	0056254	MS	Consider RIM2000	D7036802	MS	RIM2000	IK78NS	MH	RIM900
WR30X142	MS	RIM300	0056504	MH	RIM900	D7036805	MS	RIM2000	IK78NT	MH	RIM900
WR30X147	MS	RIM300	0056599	RHO	IMM8366	D7036814	MS	RIM2000	IKIANT	MH	RIM900
WR30X148	MS	RIM300	0056605	MH	RIM900	D7190101	MS	Consider RIM2000	MGIMKS	MH	RIM900
WR30X159	MS	RIM300	0056606	MH	RIM900	D7208401	MS	Consider RIM2000	MGIMKT	MH	RIM900
WR30X163	MS	RIM300	0311155	MH	RIM900	D7208402	MS	Consider RIM2000	MHIK7989	MH	RIM900
WR30X169	MS	RIM300	0312578	MH	RIM900	D7208404	MS	Consider RIM2000			
WR30X170	MS	RIM300	0312738	MH	RIM900	D7261701	MS	RIM2000			
WR30X175	MS	RIM300	0312739	MH	RIM900	D7261704	MS	RIM2000			
WR30X176	MS	RIM300	0312740	MH	RIM900	D7567101	MS	RIM115			

Styles: MH = Modular Head; MS = Mechanical Style; RHO = Replacement Head Only for Modular Style Icemaker TM= Timer Only

Icemaker Cross Reference

Maytag Brands (Cont)			Whirlpool Brands (Cont)			Whirlpool Brands (Cont)			Whirlpool Brands (Cont)		
OEM No.	Style	Supco No.	OEM No.	Style	Supco No.	OEM No.	Style	Supco No.	OEM No.	Style	Supco No.
MIP85S	MH	RIM900	1108106	MH	RIM943	482020	MH	RIM943	627572	MS	RIM500
MIP85T	MH	RIM900	1108106	MS	RIM316	482394	MH	RIM943	627797	RHO	IMM8366
MIP85T-2	MH	RIM900	1108154	MH	RIM943	482394	MS	RIM500	627801	RHO	IMM8366
NISS	MH	RIM900	1108154	MS	RIM316	482433	MH	RIM943	627811	RHO	IMM8366
NITM	MH	RIM900	1114185	MH	RIM943	482433	MS	RIM500	627816	RHO	IMM8366
R0000209	MS	RIM2000	1114185	MS	RIM313	482671	TM	SA1005	628134	RHO	IMM8366
R0130847	MS	RIM2000	1114209	MH	RIM943	482990	MH	RIM943	628135	RHO	IMM8366
R0154025	MH	RIM900	1114209	MS	RIM316	482990	MS	RIM500	628247	RHO	IMM8366
R0156628	RHO	IMM8366	1118554	MH	RIM943	483042	RHO	IMM8366	628258	RHO	IMM8366
R0156629	MH	RIM900	1118554	MS	RIM313	483101	RHO	IMM8366	628302	RHO	IMM8366
R0156669	MH	RIM900	1118555	MH	RIM943	483105	RHO	IMM8366	628305	RHO	IMM8366
R0156806	MS	RIM115	1118746	MH	RIM943	625601	MH	RIM943	628332	RHO	IMM8366
R0156806	MH	RIM900	1118746	MS	RIM313	625601	MS	RIM500	628342	RHO	IMM8366
R0156806	MS	RIM115	1118766	MH	RIM943	625603	MH	RIM943	628357	RHO	IMM8366
R0161059	MH	RIM900	1118766	MS	RIM316	625603	MS	RIM500	628366	RHO	IMM8366
R0161061	MH	RIM900	1127599	MH	RIM943	625610	MH	RIM943	628384	TM	SA1005
R0167201	MH	RIM900	1127599	MS	RIM316	625610	MS	RIM500	628384R	TM	SA1005
R0167202	RHO	IMM8366	1129303	MH	RIM943	625611	MH	RIM943	628386	TM	SA1005
R0167203	RHO	IMM8366	1129303	MS	RIM316	625611	MS	RIM500	628398	RHO	IMM8366
R0175018	MS	Consider RIM2000	1129306	MH	RIM943	625622	MH	RIM943	628399	RHO	IMM8366
R0175019	MS	Consider RIM2000	1129306	MS	RIM316	625622	MS	RIM500	797991	MH	RIM943
R0175020	MH	RIM900	1129312	MH	RIM943	625625	MH	RIM943	797991	MS	RIM500
R0175020	MS	RIM117	1129312	MS	RIM313	625625	MS	RIM500	8114	MH	RIM943
R0175021	MS	RIM115	1129313	MS	RIM313	625653	MH	RIM943	8114	MS	RIM500
R0183135	MH	RIM900	1129314	MH	RIM943	625653	MS	RIM500	833701	MH	RIM943
R0194462	RHO	IMM8366	1129316	MS	RIM316	625656	MH	RIM943	8340	MS	RIM2000
R0194666	RHO	IMM8366	1129318	MH	RIM943	625656	MS	RIM500	8390	MS	RIM2000
R0950064	RHO	IMM8366	1129318	MS	RIM316	625660	MH	RIM943	8550	MH	RIM943
RA43714-1	MH	RIM900	2155184	MH	RIM943	625660	MS	RIM500	8550	MS	RIM500
RA43714-10	MH	RIM900	2155185	MS	RIM943	626002	MH	RIM943	940556	MH	RIM943
RA43714-11	MH	RIM900	2155185	MS	RIM316	626201	MH	RIM943	940556	MS	RIM313
RA43714-12	MH	RIM900	2155186	MS	RIM943	626201	MS	RIM500	941555	MH	RIM943
RA43714-14	MH	RIM900	2155186	MS	RIM316	626237	MH	RIM943	941555	MS	RIM313
RA43714-2	MH	RIM900	2155187	MS	RIM943	626237	MS	RIM500	944804	MH	RIM943
RA43714-4	MH	RIM900	2155187	MS	RIM316	626366	MH	RIM943	944804	MS	RIM316
RA43714-6	MH	RIM900	2155188	MS	RIM943	626366	MS	RIM500	978552	MH	RIM943
RA43714-8	MH	RIM900	2155188	MS	RIM316	626461	MH	RIM943	978552	MS	RIM500
RA43714-9	MH	RIM900	2155468	MS	RIM2000	626461	MS	RIM500	978553	MH	RIM943
RA95019-1	MH	RIM900	2155469	MS	RIM316	626489	MH	RIM943	978553	MS	RIM500
RA95020-1	MH	RIM900	2155469A	MS	RIM2000	626489	MS	RIM500	978556	MH	RIM943
RKE	MH	RIM900	2171718	MS	RIM400	626500	TM	SA1005	978556	MS	RIM500
UKI1000AXX	MS	RIM2000	2171811	MS	RIM2000	626501	TM	SA1005	978556	MS	RIM500
UKI1500AXX	MS	RIM2000	2198597	MH	RIM943	626502	TM	SA1005	984827	MH	RIM943
UNIVM98	MS	RIM116	4210317	MH	RIM943	626503	TM	SA1005	984827	MS	RIM313
Sub-Zero			4210317	MS	RIM500	626504	TM	SA1005	987613	MH	RIM943
OEM No. Style Supco No.			4211173	MH	RIM943	626505	TM	SA1005	987613	MS	RIM313
4200520	MH	RIM900	4211173	MS	RIM500	626506	TM	SA1005	AMKIT97	MS	RIM2000
4200521	MH	RIM900	4317943	MH	RIM943	626507	TM	SA1005	ECKMF-64	MH	RIM943
4200522	MH	RIM900	4317943	MS	RIM500	626508	TM	SA1005	ECKMF-64	MS	RIM313
4201760	MH	RIM943	468150	MH	RIM943	626511	TM	SA1005	ECKMF-90	MH	RIM943
628366	RHO	IMM8366	480616	MH	RIM943	626512	TM	SA1005	ECKMF-90	MS	RIM316
Whirlpool Brands			480616	MS	RIM500	626513	TM	SA1005	ECKMF-94	MH	RIM943
OEM No. Style Supco No.			480617	MH	RIM943	626514	TM	SA1005	ECKMF-94	MS	RIM316
8114	MH	RIM943	480617	MS	RIM500	626517	TM	SA1005	ECKMF-97	MH	RIM943
8340	MS	RIM2000	482014	MH	RIM943	626519	TM	SA1005	ECKMF-97	MS	RIM316
8390	MS	RIM2000	482014	MS	RIM500	626519R	TM	SA1005	IMKIT	MH	RIM943
8550	MH	RIM943	482015	MH	RIM943	626520	TM	SA1005	KIMF81	MH	RIM943
81503	MS	RIM2000	482015	MS	RIM500	626522	TM	SA1005	KIMS8	MH	RIM943
4389195	TM	SA1005	482016	MH	RIM943	626524	TM	SA1005			
106.8114	MH	RIM943	482016	MS	RIM500	626608	MH	RIM943			
106.81503	MS	RIM2000	482017	MH	RIM943	626608	MS	RIM500			
106.8340	MS	RIM2000	482017	MS	RIM500	626609	MH	RIM943			
106.8390	MS	RIM2000	482018	MH	RIM943	626609	MS	RIM500			
106.8550	MH	RIM943	482018	MS	RIM500	626626	MH	RIM943			
1105298	MH	RIM943	482019	MH	RIM943	626626	MS	RIM500			
1105298	MS	RIM313	482019	MS	RIM500	627572	MH	RIM943			

Note: Some manufacturer's include splices to direct wire icemakers into older applications. Supco does not recommend direct wiring.

Styles: MH = Modular Head; MS = Mechanical Style; RHO = Replacement Head Only for Modular Style Icemaker TM= Timer Only

Icemaker Parts

Icemaker / Humidifier Installation Kits

Supco No.	Description	Tubing	Valve	Valve Type	Connection At Tap	Connection At Appliance
IST2	Valve and Fittings, no tubing	STV2	Self Tapping	1/4" compression	1/4" compression
PT25	Valve, 25 foot plastic tubing and all fittings	Plastic	STV2	Self Tapping	1/4" compression	1/4" compression
PT25E	Valve, 25 foot plastic tubing and 2 most popular fittings	Plastic	STV2	Self Tapping	1/4" compression	1/4" compression
C15	Valve, 15 foot 1/4" O.D. copper tubing and all fittings	Copper	STV2	Self Tapping	1/4" compression	1/4" compression
C25	Valve, 25 foot 1/4" O.D. copper tubing and all fittings	Copper	STV2	Self Tapping	1/4" compression	1/4" compression
C15F	Valve, 15 foot 1/4" O.D. copper tubing and all fittings, and one flare	Copper	STV2	Self Tapping	1/4" compression	1/4" Flare
C25F	Valve, 25 foot 1/4" O.D. copper tubing and all fittings, and one flare	Copper	STV2	Self Tapping	1/4" compression	1/4" Flare
C15D	Valve, 15 foot 1/4" O.D. copper tubing and all fittings	Copper	STV2D	Pre-Drill	1/4" compression	1/4" Flare
C25D	Valve, 25 foot 1/4" O.D. copper tubing and all fittings	Copper	STV2D	Pre-Drill	1/4" compression	1/4" Flare
C15FD	Valve, 15 foot 1/4" O.D. copper tubing and all fittings, and one flare	Copper	STV2D	Pre-Drill	1/4" compression	1/4" Flare
C25FD	Valve, 25 foot 1/4" O.D. copper tubing and all fittings, and one flare	Copper	STV2D	Pre-Drill	1/4" compression	1/4" Flare

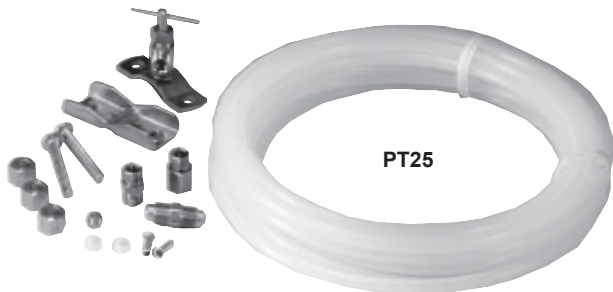

Icemaker Installation Kit Quick Chart

Brand	OEM No.	Supco No.
Electrolux	5305510264	C25
	S5305510264	C25D
Maytag	18001005	C25D
	18001006	PT25E
	25001812	C25D
	25002012	C25
Whirlpool	8003	C25D

Water Filters



WF270



WF271

In-line Water Filters

Designed to replace most inline charcoal and carbon water filters. These high capacity filters remove sediment, chlorine taste, and odor from water. Excellent for icemakers, coffee makers, and water dispensers.

Features

- Improves taste and odor
- Removes particulates and turbidity
- High capacity
- Replaces charcoal and carbon filled filters.
- Rated 20 to 125 PSI to work on municipal water systems
- Installs using standard 1/4" Compression fittings
- Filtration to 20 microns
- For use on approved water systems to improve water quality

Supco No.	Filter Media	Capacity Gallons	Max. Flow Gal/Min	Pounds per Day	Length	Diameter	Taste / Odor	Scale / Lime
WF270	Carbon	1,000	1	65	6 3/8"	1 5/8"	Yes	No
WF271	Carbon	4,000	1	100	10"	2 1/4"	Yes	No

Direct Replacement Water Filters

WF282 Direct Replacement Water Filter Cartridge

Designed as a direct replacement for many models. Follow appliance users manual for installation. Filter is for use on approved water supplies to improve water quality. See filter capability below.

Features

- Typical particle reduction .5 to 1 micron
- Pressure range 40 to 125 PSI
- Temperature range 33° to 100°F
- Removes sediment and particulates
- Rated at 750 gallons or 6 months
- Rated at .5 GPM 1.9 LPM @ 60 PSI

- Direct replacement
- Improves taste and odor

Reduces

- Atrazine 76.00%
- Chlorine 97.00%
- Cysts 99.99%
- Lead 99.00%
- Lindane 99.00%
- Sediment 99.00%
- Turbidity 99.00%



WF282 Replaces	
GE	GSWF
Sears /Kenmore	9914 46-9914

Water Filters

WF284 Direct Replacement Water Filter Cartridge

Designed as a direct replacement for the enhanced and standard water filters. Follow appliance users manual for installation. Filter is for use on approved water supplies to improve water quality. See filter capability below.



Features

- Typical particle reduction to 1 micron
- Pressure range 20 to 100 PSI
- Temperature range 33° to 100°F
- Removes sediment and particulates
- Rated at 400 gallons or 6 months
- Direct replacement, not a kit
- Improves taste and odor
- Body size 4" X 1 3/4" OAL 4 1/4"

Reduces

2,4-D (Herbicide)	94.20%
Atrazine	94.90%
Chlorine (Class I)	97.80%
Cysts	99.99%
Lead	99.00%
Particulates Class I)	99.80%
Toxaphene (Pesticide)	87.50%
Turbidity	99.70%

WF284				
Replaces				
Electrolux	218710901	Pure Source	RC101	
	218710902		RC200	
	218717805		RF100	
	240389101		RF200	
	5303917752		RG100	
	5303917836		Sears / Kenmore	46-9906
	5303917937			46-9906P
	5303918017			46-9910
	WF1CB			46-9910P
	WFB			9906
WFCB	9906P			
		9910		
		9910P		

Valves & Fittings

STV Series Self-Tapping Water Valves

Features

- Self piercing on copper tubing or 0.035" wall hard PVC
- Fits 3/8" O.D. through 1 3/8" O.D. tubing or pipe
- Can be installed on pipe with existing hole
- Stainless steel piercing needle

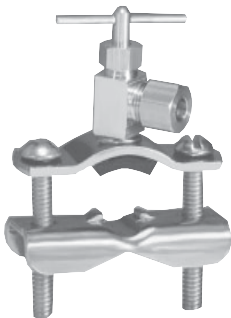

PART NO.	FLOW RATE	OUTLET	PIERCING NEEDLE	APPLICATION	COMMENTS
STV2	1 GPM	1/4" Comp.	1/8" Dia. (Hollow)	Ice Maker Kits	Reversible lower bracket
STV3	1 GPM	1/4" Comp.	1/8" Dia. (Hollow)	Humidifier Kits	
STV4	1 GPM	1/4" Comp.	3/32" Dia. (Solid, retractable)	Humidifier Kits	1/8" M.P.T. on body valve included

STV2D Conventional "Drill" Type Valve

Features

- Must pre-drill 1/4" hole in pipe or tubing
- Increased water flow from standard water valve
- Fits up to 1 3/8" O.D. Copper tubing
- Fits 1/2" or 3/4" galvanized iron water pipe
- Maximum water temperature 180°F/82°C
- Includes all fittings for 1/4" O.D. copper and plastic tubing

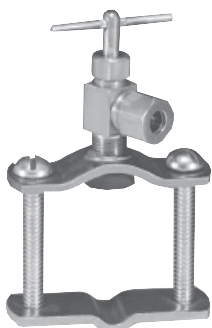

Relays, Overloads & Hard Starts

For Refrigeration Systems Without Run Capacitors

SUPCO offers the most complete line of refrigeration relays, overloads and hard starts in the industry. For refrigeration systems with and without run capacitors, just choose the right combination for your application. All combinations are pre-wired for fast installation.



ICG

ICG and PO Series Relays

Features/Benefits

- ICG Series features a “snap-on” bracket
- PO Series installs on compressors with “pin-type” terminals.
- Fastest cool down time of any solid state relays
- Can be used with and without start capacitor.

Applications

- One size for all compressors from 1/12 hp through 1/2 hp.
- Replaces all current type relays.

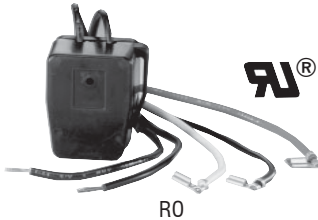

RO

RO & PRO Series Relay and Overload Combinations

Features/Benefits

- RO Series features “snap-on” bracket
- PRO Series installs on “pin-type” terminal.
- Locked rotor protection eliminates start winding overheating
- Can be used with and without start capacitor motors from 1/4 to 1/3 hp.

Applications

- Select the right match to replace refrigerator compressor relay and overload units from 1/12 through 2/3 hp, 115 – 230 VAC.



RSC

RSC Series Relay and Start Capacitor Combination

Features/ Benefits

- Replaces current-type relays
- Provides a boost for hard start and unbalanced systems
- Prevents low voltage starting problems
- No additional wires required

Applications

- One size for all compressors from 1/12 hp through 1/2 hp.
- For domestic and commercial refrigeration systems and freezers



RCO

RCO Series 3 N' 1 Relay, Overload and Start Capacitor Combination

Features/Benefits

- Replaces relay, overload and provides a boost for hard start and unbalanced systems
- Prevents low voltage starting problems

Applications

- Select the right match to replace refrigerator compressor relay and overload units from 1/12 through 2/3 hp, 115 – 230 VAC.
- For all capillary systems



SS410

SS410 Super Start Relay Overload Combination

Features/Benefits

- Equipped with an electro-mechanical relay, locked rotor protector and a 255 mfd start capacitor.
- Increases torque to its maximum capacity

Applications

- For all motors including high starting torque motors from 1/4 to 1/3 hp.

Selection Table For Refrigeration Systems Without Run Capacitors

SUPCO NO.	RELAY	OVERLOAD	START CAPACITOR	MOUNTING	HP RATING	VOLTAGE (VAC)
ICG1	*			Quick Connect	1/12 - 1/2	115
ICG-220	*			Quick Connect	1/12 - 1/2	230
PO115	*			Push - on	1/12 - 1/2	115
PO230	*			Push - on	1/12 - 1/2	230
R081	*	*		Quick Connect	1/12 - 1/5	115
R041	*	*		Quick Connect	1/4 - 1/3	115
R021	*	*		Quick Connect	1/2	115
R082	*	*		Quick Connect	1/12 - 1/8	230
R062	*	*		Quick Connect	1/6 - 1/5	230
R042	*	*		Quick Connect	1/4 - 1/3	230
R022	*	*		Quick Connect	1/2 - 2/3	230
PRO81	*	*		Push - on	1/12 - 1/5	115
PRO41	*	*		Push - on	1/4 - 1/3	115
PRO21	*	*		Push - on	1/2	115
PRO82	*	*		Push - on	1/12 - 1/8	230
PRO62	*	*		Push - on	1/6 - 1/5	230
PRO42	*	*		Push - on	1/4 - 1/3	230
PRO22	*	*		Push - on	1/2 - 2/3	230
RSC10	*		*	Quick Connect	1/12 - 1/2	115
RSC20	*		*	Quick Connect	1/12 - 1/2	230
RCO810	*	*	*	Quick Connect	1/12 - 1/5	115
RCO410	*	*	*	Quick Connect	1/4 - 1/3	115
RCO210	*	*	*	Quick Connect	1/2	115
RCO820	*	*	*	Quick Connect	1/12 - 1/8	230
RCO620	*	*	*	Quick Connect	1/6 - 1/5	230
RCO420	*	*	*	Quick Connect	1/4 - 1/3	230
RCO220	*	*	*	Quick Connect	1/2	230
SS410	*	*	*	Quick Connect	1/4 - 1/3	115

Relays, Overloads & Hard Starts

For Refrigeration Systems With Run Capacitors

For servicing newer technology systems developed during the last decade. These relays, overloads and hard start combinations can also be used on systems without run capacitors.



UPRO



URO & UPRO Series Relay and Overload Combinations

Features/Benefits

- Safe, reliable, long lasting PTC relay
- Locked rotor protection eliminates start winding overheating
- Can be used with and without start

Applications

- Select the right match to replace refrigerator compressor relay and overload units from 1/12 through 2/3 hp, 115 – 230 VAC.



URSC



URSC Series Relay and Start Capacitor Combination

Features/Benefits

- Replaces current-type relays
- Provides a boost for hard start and unbalanced systems
- Prevents low voltage starting problems
- No additional wires required

Applications

- One size for all compressors from 1/12 hp through 1/2 hp.
- For domestic and commercial refrigeration systems and freezers



URCO



URCO Series 3 N' 1 Relay, Overload and Start Capacitor Combination

Features/Benefits

- Replaces relay, overload and provides a boost for hard start and unbalanced systems
- Prevents low voltage starting problems

Applications

- Select the right match to replace refrigerator compressor relay and overload units from 1/12 through 2/3 hp, 115 – 230 VAC.

Selection Table For Refrigerator Systems With Run Capacitors

SUPCO NO.	RELAY	OVERLOAD	START CAPACITOR	MOUNTING	HP RATING	VOLTAGE (VAC)
URO81	*	*		Quick Connect	1/12 - 1/5	115
URO41	*	*		Quick Connect	1/4 - 1/3	115
URO21	*	*		Quick Connect	1/2	115
URO82	*	*		Quick Connect	1/12 - 1/8	230
URO62	*	*		Quick Connect	1/6 - 1/5	230
URO42	*	*		Quick Connect	1/4 - 1/3	230
URO22	*	*		Quick Connect	1/2 - 2/3	230
UPRO81	*	*		Push - on	1/12 - 1/5	115
UPRO41	*	*		Push - on	1/4 - 1/3	115
UPRO82	*	*		Push - on	1/12 - 1/8	230
UPRO62	*	*		Push - on	1/6 - 1/5	230
UPRO42	*	*		Push - on	1/4 - 1/3	230
UPRO22	*	*		Push - on	1/2 - 2/3	230
URSC10	*		*	Quick Connect	1/12 - 1/2	115
URSC20	*		*	Quick Connect	1/12 - 1/2	230
URCO81	*	*	*	Quick Connect	1/12 - 1/5	115
URCO41	*	*	*	Quick Connect	1/4 - 1/3	115
URCO21	*	*	*	Quick Connect	1/2	115
URCO82	*	*	*	Quick Connect	1/12 - 1/5	230
URCO62	*	*	*	Quick Connect	1/6 - 1/5	230
URCO42	*	*	*	Quick Connect	1/4 - 1/3	230
URCO22	*	*	*	Quick Connect	1/2	230

* URO replaces all UR

Direct Replacement Solid State Relays, Overloads and Relay/Overload Combinations

- Direct Replacements for numerous OEM's
- Use OL Series Overloads with IC Series, PO Series and UR115



IC100



OL1

SUPCO NO.	RELAY	OVERLOAD	HORSEPOWER	VAC	# OF TERMINALS	COMPRESSOR CONNECTIONS	CAPATIBLE	CAPACITOR REPLACES OEM NO.
IC100	*	---	1/12 to 1/3	120	2	2	Yes	216594300, WR7X194, WR7X214, 4318083
IC102	*	---	1/12 to 1/3	120	3	2	Yes	5303007173, WR7X240, WR7X5142, 68857-1
		---	1/12 to 1/3	120	2	2	Yes	WR7X10011, WR7X190, WR7X195, WR7X259, 66858-1, 3204873
OL1	---	*	1/5 to 1/4	120/240	1	1	---	5303299560, 216100110
OL2	---	*	1/4 to 1/3+	120/240	1	1	---	5303270406, WR8X122
OL3	---	*	1/6 to 1/5	120/240	1	1	---	5303276514
OL4	---	*	1/4 to 1/3+	120/240	1	1	---	5303206885, 2154945

Relays, Overloads & Hard Starts

OV Series Universal Replacement Motor Protectors

Features

- Built in temperature activated disc opens and closes the motor overload protector's contacts.
- Excessive heat generated by the compressor, motor or crankcase heater will open the contacts to help protect the equipment from serious damage or burnout.
- UL and CSA Approved

Applications

- Used in heat pumps, air conditioners, motors, refrigerators, freezers, pumps, water coolers, and heating applications.



OVKIT

Overload Kit

- Contains one of each overload (10 total)



Horsepower at 120 Volts

SUPCO NO.	LOCKED ROTOR AMPS												GEM NO.	MARS NO.	
	12.0	13.5	1/20	1/1	1/10	1/8	1/6	1/5	1/4	1/3	1/2	3/4			
OV32	12.0	13.5	•	•										MP359	35004
OV34	14.0	15.5		•	•	•	•	•						MP358	35007
OV36	16.0	18.0			•	•	•	•						MP357	35009
OV38	18.5	22.0			•	•	•	•	•					MP354	35010
OV40	22.5	26.5					•	•	•					MP360	35011
OV42	27.0	31.0					•	•	•					MP355	35012
OV44	31.5	35.5								•	•			MP361	35017
OV46	36.0	40.0								•	•	•		MP352	35018
OV48	40.5	44.5								•	•	•		MP351	35019
OV50	45.0	49.0									•	•		MP362	35020

Horsepower at 240 Volts

SUPCO NO.	LOCKED ROTOR AMPS														GEM NO.	MARS NO.
	12.0	13.5	1/10	1/8	1/6	1/5	1/4	1/4+	1/3	1/3+	1/2	1/2+	3/4	1		
OV32	12.0	13.5	•	•	•	•	•	•	•						MP359	35004
OV34	14.0	15.5	•	•	•	•	•	•	•						MP358	35007
OV36	16.0	18.0				•	•	•	•	•					MP357	35009
OV38	18.5	22.0				•	•	•	•	•	•				MP354	35010
OV40	22.5	26.5						•	•	•	•	•	•	•	MP360	35011
OV42	27.0	31.0						•	•	•	•	•	•	•	MP355	35012
OV44	31.5	35.5										•	•	•	MP361	35017
OV46	36.0	40.0										•	•	•	MP352	35018
OV48	40.5	44.5										•	•	•	MP351	35019
OV50	45.0	49.0											•	•	MP362	35020

This application guide is offered as a guide only when no other information is available.

The application will vary with compressor manufacturer's systems and condenser applications (static, fan, and water cooled, etc.)

Other factors include refrigerant, motor type, and efficiency.

Application Note:

Locked Rotor Amperage Measurement.

To determine the locked rotor amperage use the following procedure:

1. Disconnect source of electrical supply.
2. By-pass defective overload with jumper.
3. Remove wire from start terminal of compressor.
4. Place hook-on ammeter on wire going to common or run terminal of compressor.
5. Connect plug to source of current and read ammeter.
6. If unit does not have a start capacitor, add 1/2 of ampere reading to obtain the locked rotor amps.
Example: If ampere reading is 21, add 1/2 (+ 7) = 28 locked rotor amps.
7. If unit has a start capacitor, add 10% of ampere reading. Example: If ampere reading is 21, add 10% (+2.1) = 23.1 locked rotor amps.
8. Replace defective overload and replace wire removed from start terminal.

NOTE: The above procedure should only be used when the motor winding is at ambient temperature.

Relays, Overloads & Hard Starts

Motor Protector Cross Reference

HP/Type	SUPCO OV	Tecumseh O/L
1/8 Fan	OV34	83281 / 83282
		83316 / 83438
		83441 / 83461
		83473 / 83606
		83628 / 83711
1/6 Fan	OV36	83018 / 83021
1/8 Static		83042 / 83077
		83091 / 83160
		83160-1 / 83165
		83165-1 / 83191
		8191-1 / 83287
		83463 / 83691
		83006

HP/Type	SUPCO OV	Tecumseh O/L
1/5 Fan	OV38	83030 / 83131
1/6 Static		83183 / 83183-1
		83290 / 83426
		83439 / 83448
		83743 / 83743-1
	83746 / 83746-1	
	83771	
1/5 Static	OV40	8300MRT58
1/4 Fan	OV42	83011 / 83139
		83161 / 83161-1
		83163 / 83163-1
		83259 / 83289
		83292 / 83323

HP/Type	SUPCO OV	Tecumseh O/L
1/4 Static	OV44	83013 / 83017
		83036 / 83063
		83145-1 / 83172
		83172 / 83172-1
		83192 / 83192-1
		83321 / 83373
		83376-1 / 83378
		83400 / 83435
		83459 / 83647
		83681 / 83694
		83736-1 / 83766
		83376-1 / 83378
		83789

HP/Type	SUPCO OV	Tecumseh O/L
1/3 Fan	OV46	83031 / 83074
		83168 / 83168-1
		83257 / 83257-1
		83257-2 / 83293
		83307 / 83332
		83390 / 83413
		83413-1 / 83415
		83429 / 83430
		83453 / 83454
		83464 / 83498
		83498-1 / 83625
1/3 Static	OV48	83631 / 83637
		83640 / 83708
		83713 / 83714 / 83754
		8300MRT26
		8300MRT60
		83219
		83434
		83673
		83765

Door Gaskets

Refrigerator Universal Door Gaskets

Four of the most commonly used compression door gaskets. Available in 50 and 100 foot coils. All of the compression gaskets are made from refrigeration grade 100% virgin vinyl and is FDA acceptable. Gaskets 1051 and 1160 are excellent for curves with a 6 inch or larger radius; 5451 and 6662 are excellent for curves with a 2 inch or larger radius. All of the gaskets can be notched for tighter curves or corners.

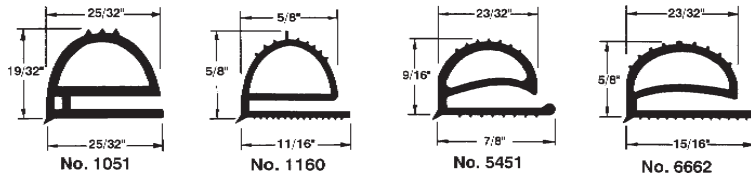

50 Foot Coil	100 Foot Coil	Color
1051-50	1051-100	White
1160-50	1160-100	White
	1160-100B	Light Blue
5451-50	5451-100	White
6662-50	6662-100	White

Four Piece Universal Door Gasket Kit

Universal replacement compression gasket kit, made to replace hundreds of older gaskets. Gasket made from refrigeration grade 100% virgin vinyl and is FDA acceptable. Ideal for older applications where a replacement gasket is no longer available. Preformed corners speed up the installation.



Supco No.	Color	Maximum Door Size
SGE517	White	67" X 67"

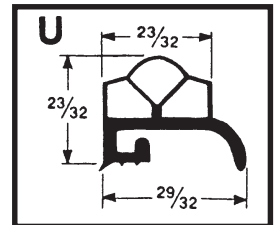

Two Piece Magnetic Universal Door Gaskets

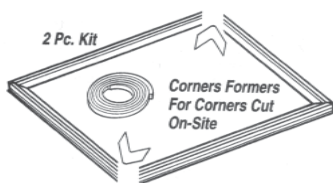

Features

- Two profiles are available
- Quick installation, only two cuts required, corner kit included. Magnetic strip included.
- Refrigeration grade virgin vinyl (FDA acceptable)

Installation

- Only two cuts required for solvent welds, use original gasket as template
- Magnetic strips are cut to size and inserted into gasket sections, prior to solvent welding.
- Corner formers speed up installation by aligning the corners for the solvent weld.

Supco No.	Color	Maximum Door Size
SU2204	White	36" X 68"
SU2213	White	36" X 68"

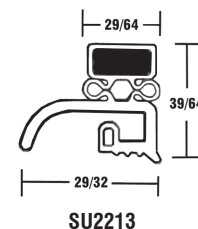
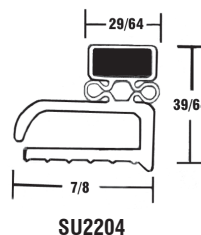

Door Gaskets

Four Piece Magnetic Universal Door Gaskets

Four styles of the most commonly used magnetic door gasket kits. Designed residential and commercial refrigerator / freezer applications where a direct replacement gasket is not available. The illustrated cross sections show the four most popular profiles used where the clearance $5/8"$ to $3/4"$. Each gasket is furnished with (4) L-shaped sections complete with factory welded corners. The magnetic insert strip is furnished in a roll. Both the gasket and magnetic strip can be easily cut to size. Available in a variety of sizes. All of the gaskets are made from refrigeration grade 100% virgin vinyl and is FDA acceptable.



Supco No.	Color	Maximum Door Size
SGE421	Brown	10" X 75 1/2"
SGE422	White	10" X 75 1/2"
SGE432	Brown	20" X 62 1/2"
SGE433	White	20" X 62 1/2"

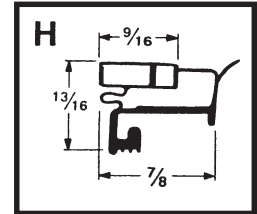

Supco No.	Color	Maximum Door Size
SU2001	White	20" X 30"
SU2002	White	32" X 42"
SU2003	White	32" X 55"
SU2004	White	36" X 84"

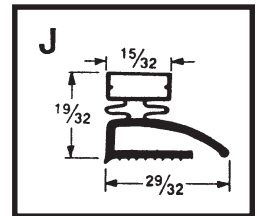

Supco No.	Color	Maximum Door Size
SU2101	White	20" X 30"
SU2102	White	32" X 42"
SU2103	White	32" X 55"
SU2104	White	36" X 84"
SU2105	White	10" X 75 1/2"
SU2106	White	20" X 62 1/2"

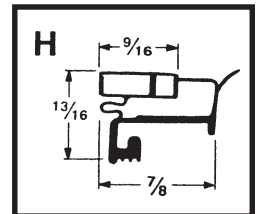

Supco No.	Color	Maximum Door Size
SU2301	White	20" X 30"
SU2302	White	32" X 42"
SU2303	White	32" X 55"
SU2304	White	36" X 84"

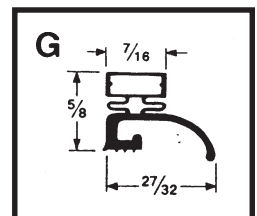

Door Gaskets

Direct Replacement Refrigerator Door Gaskets

The most common direct replacement door gaskets. A variety of profiles, sizes and colors. An alternate universal gasket kit is listed for convenience. All of the gaskets are made from refrigeration grade 100% virgin vinyl and is FDA acceptable.

Electrolux Direct Replacement Door Gaskets

OEM No.	Supco No.	Profile	Dimensions	Color	Universal Kit No.
215019104	SWC49	V	11 13/16 X 19 1/4	(TN)	
218730603	SWC26	V	27 3/4 X 44	(WH)	SU2103
218730604	SWC41	V	27 1/2 X 44	(BR)	
218730609	SWC22	V	30 5/8 X 44	(WH)	SU2103
218730610	SWC12	V	30 3/8 X 44 1/8	(TN)	
5300280162	SWE58	X	28 7/16 X 55	(WH)	
5300624974	SFR100	D	19 1/4 X 60 1/8	(WH)	SU221
5301124534	SFR85	D	13 1/4 X 28 5/8	(WH)	SU2301
5303207345	SWC61	V	29 X 43 7/8	(WH)	SU2103
5303288856	SWC55	V	16 11/16 X 27 5/8	(BR)	
5303297557	SWC58	V	27 5/8 X 43	(BR)	
5304404033	SGI47	V	30 7/16 x 40 1/8	(WH)	SU2102
5307512516	SFR75	D	30 1/2 X 53 1/4	(WH)	SU2303
5308007115	SGI46	V	30 1/4 x 41 1/2	(WH)	
5308007123	SWC20	V	16 11/16 X 27 5/8	(WH)	SU2101
5318680302	SWC21	V	27 5/8 X 43	(WH)	SU2103
5318680305	SWC23	V	13 1/2 X 21 1/2	(WH)	SU2101
5303271473	SWC66	V	27 1/2 X 39 3/4	(WH)	SU2102
6007-356-6	SPH52	L&M	14 1/8 x 29 7/16	(WH)	SU2301
6007-356-7	SPH53	L&M	29 7/16 X 39 3/4	(WH)	SU2302
K001205008	SKL36	G	28 1/2 x 42	(WH)	SU2302

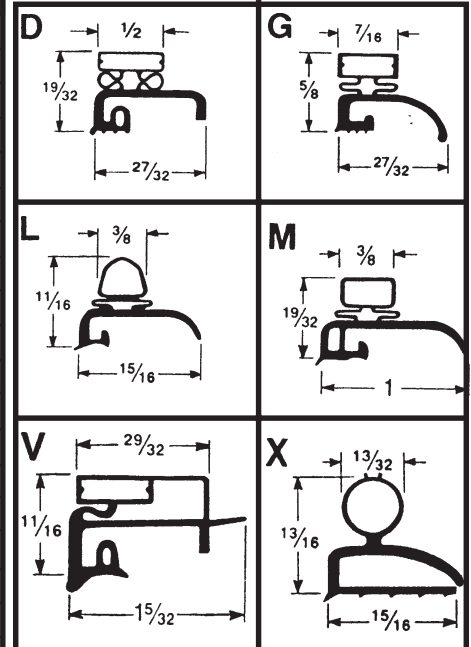

General Electric Direct Replacement Door Gaskets

OEM No.	Supco No.	Profile	Dimensions	Color	Universal Kit No.
WR24X246	SGE108	H	19 3/4 X 60 1/8	(WH)	SGE433
WR24X267	SGE117	U	18 5/8 X 28 1/8	(WH)	SU2301
WR24X271	SGE126	AB	28 3/8 X 40	(WH)	SU2302
WR24X272	SGE125	AB	28 1/4 X 41 1/2	(WH)	SU2302
WR24X273	SGE112	S	19 1/2 X 28 7/8	(WH)	SU2301
WR24X274	SGE111	S	29 X 39 3/8	(WH)	SU2302
WR24X284	SGE284	N&P	28 1/2 X 39 1/2	(BR)	
WR24X286	SGE286	F	17 1/8 x 26 3/16	(BR)	
WR24X287	SGE287	E	26 7/16 x 36 3/4	(BR)	
WR24X295	SGE295	H	19 5/8 X 59 7/8	(BR)	SGE432
WR24X300	SGE300	H	19 1/8 x 28 3/4	(BR)	SGE432
WR24X301	SGE301	A	28 5/8 X 38	(BR)	
WR24X302	SGE302	H	19 1/2 X 28 3/4	(WH)	SU2101
WR24X303	SGE303	A	28 1/2 X 38	(WH)	SU2302
WR24X309	SGE309	A	31 1/8 X 38	(BR)	
WR24X311	SGE311	N	31 1/4 X 38 1/8	(WH)	SU2302
WR24X312	SGE312	F	17 1/8 x 26 3/16	(WH)	SU2301
WR24X313	SGE127	E	26 1/4 X 36 1/2	(WH)	SU2302
WR24X315	SGE110	H	17 1/4 X 57 7/8	(WH)	SGE433
WR24X318	SGE318	A	26 1/8 X 39 3/4	(BR)	
WR24X319	SGE319	A	26 1/4 X 39 3/4	(WH)	SU2002
WR24X390	SGE390	A	32 5/8 X 38	(BR)	
WR24X421	SGE421	H	KIT 10 X 75 1/2	(BR)	SGE421

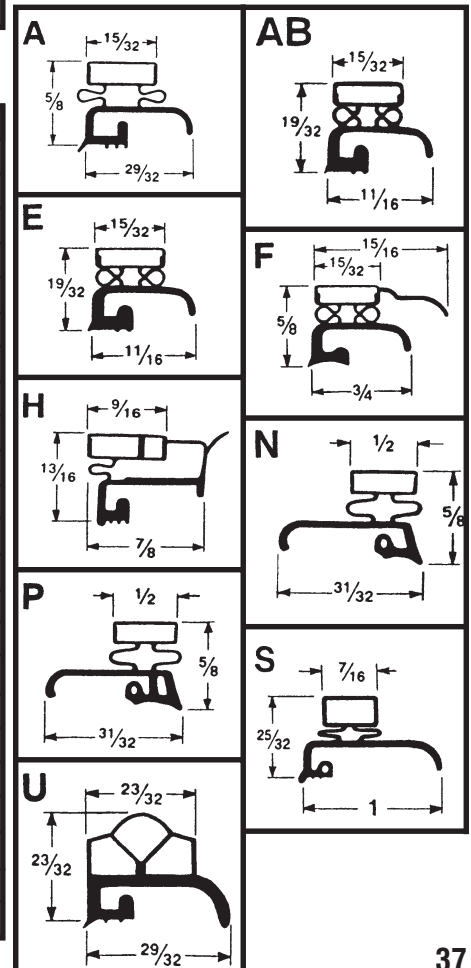

Door Gaskets

General Electric Direct Replacement Door Gaskets (continued)

OEM No.	Supco No.	Profile	Dimensions	Color	Universal Kit No.
WR24X422	SGE422	H	KIT 10 X 75 1/2	(WH)	SGE422
WR24X432	SGE432	H	KIT 20 X 62 1/2	(BR)	SGE432
WR24X433	SGE433	H	KIT 20 X 62 1/2	(WH)	SGE433
WR24X437	SGE437	AJ	32 5/8 X 39 3/8	(WH)	
WR24X438	SGE438	AJ	21 1/8 X 32 7/16	(WH)	
WR24X446	SGE446	AJ	29 3/16 x 38 3/4	(WH)	
WR24X449	SGE449	AJ	18 7/8 x 27 1/4	(WH)	
WR24X450	SGE450	AJ	27 1/4 x 38 5/8	(WH)	
WR24X454	SGE454	H	18 1/4 X 26 3/4	(BR)	SGE432
WR24X464	SGE464	H	19 5/8 X 60 9/16	(BR)	SGE432
WR24X481	SGE481	AJ	26 1/2 X 37 7/8	(BR)	
WR24X484	SGE484	AJ	16 5/8 X 26	(WH)	
WR24X485	SGE485	AJ	26 1/8 X 37 15/16	(WH)	
WR24X486	SGE486	AJ	25 15/16 X 41	(WH)	
WR24X5013	SGE107	S	26 7/16 X 40 3/4	(WH)	SU2002
WR24X5015	SGE5015	AG	27 X 45 3/4	(WH)	
WR24X517	SGE517	U	KIT 67 X 67	(WH)	SGE517
WR24X5231	SGE5231	H	19 3/4 X 60	(WH)	SGE433
WR24X5232	SGE5232	H	17 3/8 X 60	(WH)	SGE433
WR24X524	SGE524	AJ	16 5/8 X 26 1/16	(WH)	
WR24X528	SGE528	H	17 3/4 X 60	(WH)	SGE433
WR24X558	SGE558	AJ	26 X 43 1/16	(WH)	
WR24X10049	SGE485	AJ	26 1/8 X 37 15/16	(WH)	SGE485
WR24X10050	SGE484	AJ	16 5/8 X 26	(WH)	SGE484

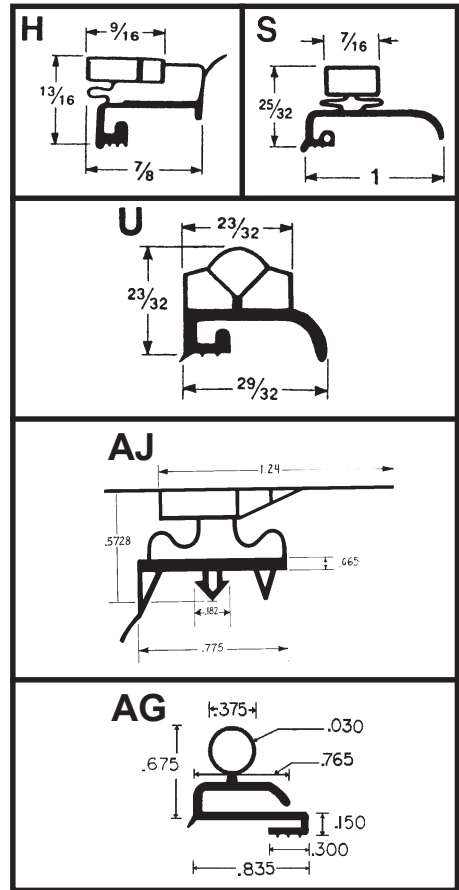

Maytag Direct Replacement Door Gaskets

OEM No.	Supco No.	Profile	Dimensions	Color	Universal Kit No.
10359709Q	SAM63	AE	14 1/4 X 61	(WH)	SU2106
12550101Q	SAM54	AE	23 3/4 X 31	(BK)	
12550109Q	SAM55	AE	28 1/2 X 39 3/4	(WH)	SU2102
12550111Q	SAM56	AE	31 1/2 X 41 1/2	(WH)	SU2102
12550112Q	SAM57	AA	18 7/8 X 31 1/4	(WH)	SU2102
12550115Q	SAM58	AE	31 1/4 X 37 3/4	(WH)	SU2102
12550116Q	SAM59	AE	23 1/2 X 31 1/4	(WH)	SU2102
24157-12	SAD38	T	20 5/8 X 58 1/2	(WH)	
56287-11	SAD77	T	15 11/16 X 28 1/8	(WH)	
66929-31	SAD76	C	18 X 60 5/8	(WH)	SU2004
66929-32	SAD82	AF	28 X 38 7/8	(WH)	SU2102
70025-2	SAD99	C	27 3/8 X 35 3/8	(WH)	SU2002
70025-4	SAD97	C	27 3/8 X 38	(WH)	SU2002
70025-5	SAD100	C	19 1/8 X 29 7/8	(WH)	SU2001
70025-6	SAD101	C	30 X 37 7/8	(WH)	SU2002
70047-1	SAD67	AA	16 3/8 X 28 1/4	(WH)	SU2101
70047-2	SAD69	AA	18 7/16 X 28 1/4	(WH)	SU2101
70047-3	SAD71	AA	19 3/8 X 30 3/4	(WH)	SU2102
70048-1	SAD68	AA	28 1/4 X 36 5/8	(WH)	SU2102
70048-2	SAD70	AA	28 1/4 X 39 1/8	(WH)	SU2102

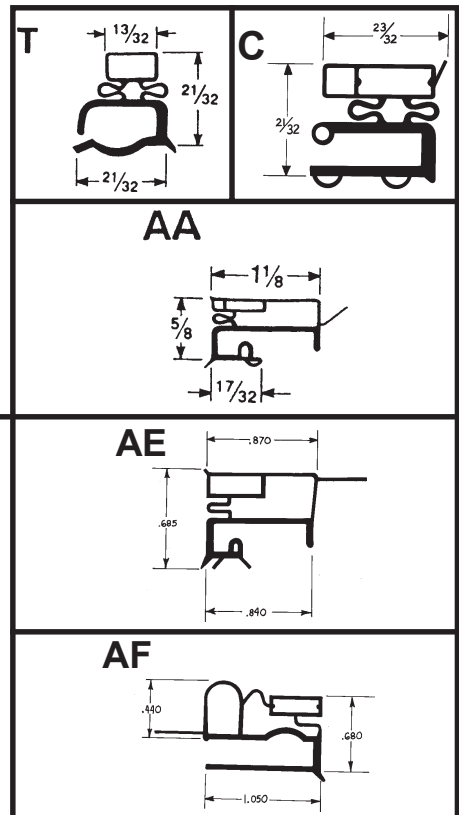

Door Gaskets

Maytag Direct Replacement Door Gaskets (continued)

OEM No.	Supco No.	Profile	Dimensions	Color	Universal Kit No.
70048-3	SAD72	AA	30 3/4 X 39 1/8	(WH)	SU2102
70048-4	SAD73	AA	32 1/4 X 39 1/8	(WH)	SU2104
70048-5	SAD81	AF	27 7/8 X 36 1/4	(WH)	SU2102
D3928207Q	SAM32	D	30 7/16 x 43	(WH)	SU2303
D7092602Q	SAM29	D	20 5/16 X 61 13/32	(WH)	SU2213
D7092608Q	SAM41	D	20 1/4 X 61 3/8	(WH)	SU2213
D7605106Q	SAM43	AE	17 1/2 X 30 3/4	(WH)	SU2102
D7605107Q	SAM44	AE	30 3/4 X 39 1/4	(WH)	SU2102
D7605108Q	SAM33	AE	19 1/4 X 30 3/4	(WH)	SU2102
D7605109Q	SAM34	AE	30 7/8 X 40 1/2	(WH)	SU2102
D7605110Q	SAM35	AE	24 X 30 3/4	(TN)	
D7605115Q	SAM39	AE	24 1/8 X 31	(WH)	SU2102
D7605116Q	SAM40	AE	30 5/8 X 35 5/8	(WH)	SU2102

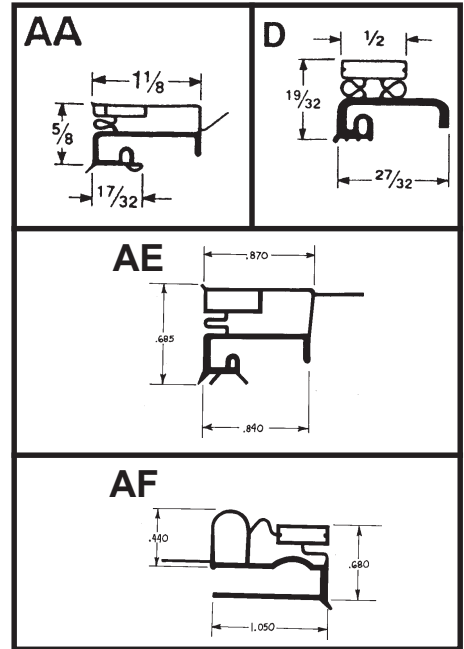

Whirlpool Direct Replacement Door Gaskets

OEM No.	Supco No.	Profile	Dimensions	Color	Universal Kit No.
510345	SCS27	L&M	30 X 39 1/2	(WH)	SU2213
576664	SCS108	AK	26 1/2 X 58 1/2	(WH)	SU2213
592945	SCS115	AK	27 X 42 1/2	(WH)	SU2213
4343449	SCS107	V	30 1/2 X 43	(WH)	SU2102
2188404A	SCS105	F	19 1/8 X 58 7/8	(WH)	SU2213
2188404A	SCS105	F	19 1/8 X 58 7/8	(WH)	SU2213
2188404A	SCS44	F	19 1/8 X 59 1/32	(WH)	SU2213
2188405A	SCS79	F	11 3/8 X 59 1/8	(WH)	SU2213
2188433A	SCS116	F	19 1/4 X 62 1/4	(WH)	SU2213
2188434A	SCS97	F	14 5/8 X 62 1/8	(WH)	SU2213
2188444A	SCS75	F	30 1/4 X 42 3/8	(WH)	SU2213
2188445A	SCS115	F	27 X 42 1/2	(WH)	SU2213
2188445A	SCS71	F	27 7/16 X 42 5/8	(WH)	SU2213
2188446A	SCS98	F	23 1/8 X 42 1/8	(WH)	SU2213
2188447A	SCS99	F	28 X 40 1/8	(WH)	SU2213
2188448A	SCS112	F	27 1/16 X 39 7/8	(WH)	SU2213
2188450A	SCS42	F	31 13/32 X 39 1/8	(WH)	SU2213
2188450A	SCS42	F	31 13/32 X 39 1/8	(WH)	SU2213
2188451A	SCS46	F	28 13/32 X 39 1/8	(WH)	SU2213
2188456A	SCS102	F	16 1/2 X 26 3/4	(WH)	SU2213
2188458A	SCS103	F	21 1/2 X 31 3/8	(WH)	SU2213
2188460A	SCS92	F	18 7/8 X 31 3/4	(WH)	SU2213
2188461A	SCS100	F	18 5/8 X 28 1/8	(WH)	SU2213
2188464A	SCS93	F	16 1/2 X 23 1/4	(WH)	SU2213

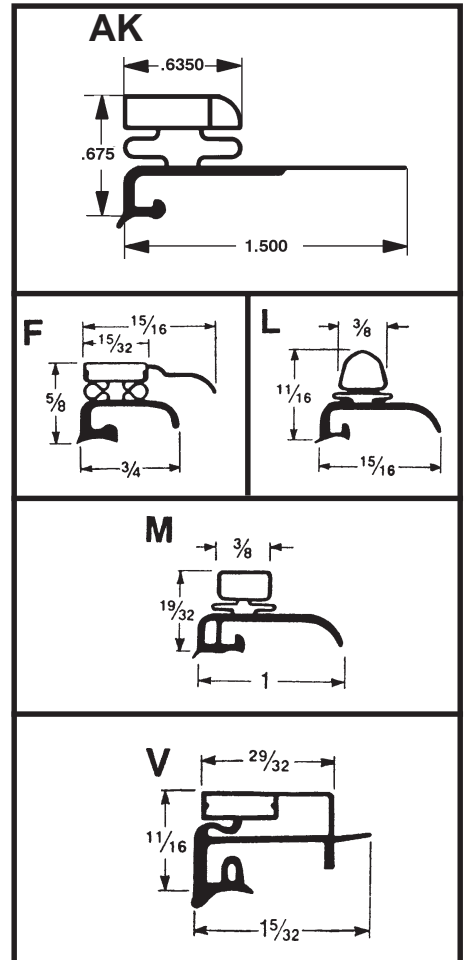

Refrigerator Door Gasket Cross Reference

Electrolux			Electrolux (Cont.)			Electrolux (Cont.)			Electrolux (Cont.)		
OEM No.	Supco No.	Universal Kit	OEM No.	Supco No.	Universal Kit	OEM No.	Supco No.	Universal Kit	OEM No.	Supco No.	Universal Kit
00622115		SU2213	08015544	SWC12		3200832		SU2106	5307541122		
00623575		SU2213	08016563		SU2102	3201013		SU2106	5307545059		SU2213
00623576		SU2213	08016625	SWC58		3201811		SU2106	5308007104	SGI47	SU2102
00623577		SU2213	08016626	SWC55		5300280162	SWE58		5308007114		SU2102
00624971		SU2213	08016627		SU2102	5300280163	SWE55		5308007115	SGI46	SU2102
00624974	SFR100	SU2213	08016628		SU2101	5300412101		SU2213	5308007122	SWC21	SU2103
00626287		SU2213	08017430	SWC49		5300412103		SU2302	5308007123	SWC20	SU2101
00627250	SFR85	SU2213	08017487	SWC12		5300462603		SU2213	5308007124		SU2102
00627766		SU2213	186803-03		SU2101	5300622114		SU2213	5308007229		SU2106
00627857		SU2213	215018201		SU2106	5300622929		SU2213	5308010244	SWC55	
00628042		SU2213	215019104	SWC49		5300622930		SU2213	5308010756		SU2102
00628810		SU2213	215608901	SWC55		5300624971		SU2213	5308011239		SU2102
00628817		SU2213	215608911	SWC20	SU2101	5300624974	SFR100	SU2213	5308015544	SWC12	
01124342		SU2213	215608912		SU2101	5300624975		SU2213	5308016563		SU2102
01124477		SU2213	215608913		SU2102	5300627766	SWC19	SU2301	5308016627		SU2102
01124534	SFR85	SU2213	215608916		SU2301	5300627857		SU2213	5308016628		SU2101
01124647		SU2213	215608931	SWC55		5300628042		SU2213	5308017430	SWC49	
01124648		SU2213	215608941	SWC20	SU2101	5300628810		SU2213	5308017487	SWC60	
01137863	SFR100	SU2213	215608943		SU2102	5300661994		SU2102	5314220908		SU2213
01138694	SFR100	SU2213	215608961	SWC55		5301124534	SFR85	SU2213	5315282802		SGE433
07510058		SU2213	215608963		SU2102	5301205009		SU2213	5315627301		SU2213
07512516	SFR75	SU2213	215608971	SWC20	SU2101	5301207363		SU2213	5317532406		SU2102
07512518		SU2213	215732401	SWC58		5301207364		SU2213	5317532408		SU2102
07512520		SU2102	215732402	SWC41		5303001304	SWC55		5317532506		SU2106
07516628	SFR75	SU2213	215732403	SWC12		5303001398	SWC58		5318680302	SWC21	SU2103
07516629	SFR75	SU2213	215732411	SWC21	SU2103	5303001399	SWC55		5318680305	SWC23	SU2101
07516633		SU2213	215732412	SWC26	SU2103	5303001517	SWC41		5318680311	SWC26	SU2103
07541121	SFR85	SU2213	215732413	SWC59	SU2103	5303017373	SWC41		5318680314		SU2102
07541122		SU2213	215732461	SWC58		5303018555	SWC22	SU2103	5318693207	SGI47	SU2102
07544249		SU2213	215732462	SWC41		5303018791		SU2101	53337	SWC58	
07544341		SU2213	215732463	SWC12		5303018792	SWC22	SU2103	53338	SWC55	
07544342	SFR75	SU2213	215740401		SU2301	5303200258	SWC20	SU2101	53339	SWC41	
07544594		SU2213	215740402		SU2302	5303200274	SWC49		53900	SWC12	
07544595		SU2213	215776701	SWC55		5303200799	SWC49		6007-356-1		SU2213
07545059		SU2213	215776711	SWC20	SU2101	5303200832		SU2106	6007-356-2		SU2213
08000130		SU2102	215776761	SWC55		5303201013		SU2106	6007-356-3		SU2213
08000131	SGI47	SU2102	218730603	SWC26	SU2103	5303206633		SU2102	6007-356-4		SU2213
08000289		SU2102	218730604	SWC41		5303206641	SWC22	SU2103	6007-356-6	SPH52	SU2301
08000290	SGI46	SU2102	218730604	SWC71		5303207112		SU2213	6007-356-7	SPH53	SU2302
08000795		SU2106	218730609	SWC22	SU2103	5303207113		SU2303	6007-356-8		SU2213
08000816	SWC21	SU2103	218730609	SWC59	SU2103	5303207115		SU2213	6007-356-9		SU2213
08000817	SWC20	SU2101	218730610	SWC12		5303207345	SWC61	SU2103	6007-356-11		SU2213
08000998		SU2106	2656D45A01		SU2213	5303271473	SWC66	SU2102	622931		SU2213
08001010		SU2102	2657D67A01		SU2213	5303275771	SWC22	SU2103	622970		SU2213
08001011		SU2101	2657D67A02		SU2213	5303275772	SWC12		626288		SU2213
08003887		SU2213	2658D36A02		SU2213	5303275788		SU2102	627251		SU2213
08007103		SU2102	2659D52A01		SU2213	5303276825		SU2101	627766		SU2213
08007104	SGI47	SU2102	2659D52A03		SU2213	5303280061		SU2102	63442-6		SU2102
08007114		SU2102	2659D52A04		SU2303	5303288856	SWC55		6583286		SU2213
08007115	SGI46	SU2102	2659D79A02		SU2213	5303288857	SWC41		66199-4		SU2102
08007122	SWC21	SU2103	3001304	SWC55		5303297557	SWC58		7546760		SU2213
08007123	SWC20	SU2101	3001317	SWC58		5303299394	SWC61	SU2103	86605	SWC58	
08007124		SU2102	3001398	SWC58		5304404033	SGI47	SU2102	86607		SU2102
08007125		SU2101	3001399	SWC55		5304404034		SU2102	86609	SWC41	
08007229		SU2106	3001416	SWC12		5304404035		SU2101	C000069003	SWE58	
08007230		SU2106	3001517	SWC41		5304404036		SU2102	C000069013	SWE58	
08009733	SWC41		3007136		SU2106	5304404037		SU2102	C000089757	SWE58	
08009735	SWC12		3017373	SWC41		5306583289		SU2213	C000094054		SU2303
08010243	SWC58		3018238	SWC12		5307112517		SU2213	C000094059		SU2213
08010244	SWC55		3018555	SWC22	SU2103	5307510058		SU2213	C000094060		SU2213
08010245		SU2102	3018633		SU2106	5307510063		SU2213	C000094062		SU2213
08010246		SU2101	3018791		SU2101	5307512516	SFR75	SU2213	C000094063		SU2213
08010247		SU2106	3018792	SWC22	SU2103	5307512518		SU2213	C000280162	SWE58	
08010249	SWC49		3200258	SWC20	SU2101	5307512519		SU2213	C000460495		SU2213
08010755	SGI47	SU2102	3200261	SWC26	SU2103	5307512520		SU2102	C000460825		SU2213
08010756		SU2102	3200274	SWC49		5307514191		SU2213	C280162	SWE58	
08011239		SU2102	3200799	SWC49		5307516633		SU2213	G161588-01		SU2102

Refrigerator Door Gasket Cross Reference

Electrolux (Cont.)			Electrolux (Cont.)			General Electric (Cont.)			General Electric (Cont.)		
OEM No.	Supco No.	Universal Kit	OEM No.	Supco No.	Universal Kit	OEM No.	Supco No.	Universal Kit	OEM No.	Supco No.	Universal Kit
G161588-02	SGI47	SU2102	K1205009		SU2213	WR24X168	SU2213	SGE517	WR24X281	SU2104	
G161588-03		SU2102	K1205010	SKL37	SU2301	WR24X169		SGE517	WR24X282	SGE517	
G161588-04	SGI46	SU2102	K1207363		SU2213	WR24X170		SGE517	WR24X283	SGE517	
G161588-06		SU2102	K1207364		SU2213	WR24X171		SGE517	WR24X284		SGE284
G161588-07	SWC23	SU2101	R000412101		SU2213	WR24X172		SGE517	WR24X286		SGE286
G161588-08	SWC21	SU2103	R000412103		SU2302	WR24X173		SGE517	WR24X287		SGE287
G161588-09	SWC20	SU2101	R000447303		SU2213	WR24X175		SGE517	WR24X288		SGE284
G165381-06		SU2106	R000462603		SU2213	WR24X176		SGE517	WR24X289	SGE421	SGE421
G165382-03		SU2106	R000901048		SU2102	WR24X177		SGE517	WR24X291		SGE421
G168930-02	SWC21	SU2103	R000901098	SWC12		WR24X178		SGE517	WR24X293		SGE432
G168930-03	SWC20	SU2101	R000901154	SWC41		WR24X179		SGE517	WR24X294		SGE432
G168930-04		SU2102	R009000103	SWC20	SU2101	WR24X181		SGE517	WR24X295	SGE295	SGE432
G168930-05	SWC23	SU2101	R009000110	SWC21	SU2103	WR24X182		SGE517	WR24X296		SGE432
G168930-06		SU2102	R186932-02	SWC58		WR24X191		SGE517	WR24X297		SGE432
G168930-07	SGI47	SU2102	R186932-03	SWC55		WR24X192		SGE517	WR24X298		SU2301
G168930-08		SU2102	R462603		SU2213	WR24X193		SGE517	WR24X299		SGE421
G168930-09	SGI46	SU2102	WR412101		SU2213	WR24X194		SGE517	WR24X300	SGE300	SGE432
G175324-02	SWC21	SU2103	WR412103		SU2302	WR24X200		SGE517	WR24X301	SGE301	
G175324-03	SWC20	SU2101	WR447303		SU2213	WR24X202		SGE517	WR24X302	SGE302	SU2101
G175324-04		SU2102	WR462603		SU2213	WR24X203	SGE117	SGE517	WR24X303	SGE303	SU2302
G175324-05	SWC23	SU2101				WR24X204		SGE517	WR24X304		SGE433
G175324-06		SU2102				WR24X205		SGE517	WR24X305	SGE305	SGE432
G175324-07	SGI47	SU2102				WR24X206		SGE517	WR24X306		SU2104
G175324-08		SU2102				WR24X207		SGE517	WR24X307		SU2104
G175324-09	SGI46	SU2102	WR14X5027		SGE433	WR24X212		SU2304	WR24X308	SGE308	SGE421
G175324-11	SWC26	SU2103	WR14X5034		SU2003	WR24X218		SGE422	WR24X309		SGE309
G175324-13	SWC22	SU2103	WR14X5035		SU2002	WR24X219		SGE422	WR24X310		SGE422
G175325-02		SU2106	WR14X5036		SGE422	WR24X220		SGE517	WR24X311	SGE311	SU2302
G175325-06		SU2106	WR14X5037		SGE422	WR24X221	SGE117	SGE517	WR24X312	SGE312	SU2301
G180547-02	SWC58		WR14X5038		SU2204	WR24X222		SGE517	WR24X313	SGE127	SU2302
G180547-03	SWC55		WR14X5039		SU2204	WR24X228		SGE517	WR24X314		SGE433
G180547-04		SU2102	WR14X5041		SU2204	WR24X229		SGE517	WR24X315	SGE110	SGE433
G180547-05		SU2101	WR24X10049	SGE485		WR24X230		SGE433	WR24X316		SU2104
G180547-06		SU2102	WR24X10050	SGE484		WR24X231		SGE433	WR24X317		SU2104
G180547-07	SGI47	SU2102	WR24X118		SGE517	WR24X232		SGE517	WR24X318		SGE318
G180547-08		SU2102	WR24X121		SGE517	WR24X233		SU2304	WR24X319	SGE319	SU2002
G180547-11	SWC41		WR24X122		SGE517	WR24X244		SGE433	WR24X334		SU2304
G180547-13	SWC12		WR24X124		SGE517	WR24X245		SGE433	WR24X389	SGE389	SGE421
G180551-01		SU2106	WR24X125		SGE517	WR24X246	SGE108	SGE433	WR24X390		SGE390
G180551-04	SWC49		WR24X129		SGE517	WR24X247		SGE433	WR24X391	SGE391	SGE422
G186556-03		SU2106	WR24X130		SGE517	WR24X248		SGE433	WR24X392	SGE392	SGE422
G186803-02	SWC21	SU2103	WR24X132		SGE517	WR24X249		SGE433	WR24X408		SU2104
G186803-03	SWC20	SU2101	WR24X134		SGE517	WR24X250	SGE112	SU2301	WR24X409		SU2104
G186803-04		SU2102	WR24X135		SGE517	WR24X251	SGE111	SU2302	WR24X410		SGE433
G186803-05	SWC23	SU2101	WR24X137		SGE517	WR24X252		SGE433	WR24X411		SGE432
G186803-11	SWC26	SU2103	WR24X138		SGE517	WR24X255	SGE112	SU2301	WR24X412		SGE433
G186803-12		SU2101	WR24X139		SGE517	WR24X256		SU2303	WR24X413		SGE287
G186803-13	SWC22	SU2103	WR24X141		SGE517	WR24X259		SU2303	WR24X414	SGE127	SU2302
G186803-14		SU2102	WR24X142		SGE517	WR24X260		SGE517	WR24X415		SGE432
G186932-02	SWC58		WR24X143		SGE517	WR24X261		SGE517	WR24X416		SGE432
G186932-03	SWC55		WR24X144		SGE517	WR24X262	SGE312	SU2301	WR24X418		SGE432
G186932-04		SU2102	WR24X148		SGE517	WR24X263	SGE127	SU2302	WR24X419		SGE432
G186932-05		SU2101	WR24X149		SGE517	WR24X265		SGE517	WR24X420		SGE432
G186932-06		SU2102	WR24X150		SGE517	WR24X266		SGE517	WR24X421	SGE421	SGE421
G186932-07	SGI47	SU2102	WR24X151		SGE517	WR24X267	SGE117	SGE517	WR24X422	SGE422	SGE422
G186932-08		SU2102	WR24X152		SGE517	WR24X268		SGE517	WR24X4	SGE424	SGE432
G186932-11	SWC41		WR24X153		SGE517	WR24X269		SGE517	WR24X427		SGE432
G186932-13	SWC12		WR24X154		SGE517	WR24X270		SU2301	WR24X428		SGE422
G191723-13	SWC22	SU2103	WR24X155		SGE517	WR24X271	SGE126	SU2302	WR24X429		SGE421
K001205007		SU2213	WR24X157		SGE517	WR24X272	SGE125	SU2302	WR24X430		SGE422
K001205008	SKL36	SU2302	WR24X159		SGE517	WR24X273	SGE112	SU2301	WR24X431		SGE318
K001205009		SU2213	WR24X160		SGE517	WR24X274	SGE111	SU2302	WR24X432	SGE432	SGE432
K1201771		SU2213	WR24X161		SGE517	WR24X275		SU2104	WR24X433	SGE433	SGE433
K1201772	SKL36	SU2302	WR24X162		SGE517	WR24X276		SU2102	WR24X437		SGE437
K1201773		SU2213	WR24X163		SGE517	WR24X277		SU2101	WR24X439		SGE301
K1205007		SU2213	WR24X164		SGE517	WR24X279		SU2104	WR24X440	SGE303	SU2302
K1205008	SKL36	SU2302	WR24X166		SGE517	WR24X280		SU2104	WR24X441		SU2104
			WR24X167		SGE517						

Refrigerator Door Gasket Cross Reference

General Electric (Cont.)			Gemline			Gemline (Cont.)			Gemline (Cont.)		
OEM No.	Supco No.	Universal Kit	OEM No.	Supco No.	Universal Kit	OEM No.	Supco No.	Universal Kit	OEM No.	Supco No.	Universal Kit
WR24X446	SGE446		2001	SU2001	SU2001	CS59	SCS102	SU2301	GE168		SGE433
WR24X449	SGE449		2002	SU2002	SU2002	CS60	SCS115	SU2303	GE169		SGE433
WR24X450	SGE450		2003	SU2003	SU2003	FR105		SU2302	GE170		SGE433
WR24X454		SGE432	2004	SU2004	SU2004	FR106		SU2301	GE172	SGE392	SGE422
WR24X464	SGE464	SGE432	2301	SU2301	SU2301	FR112		SU2303	GE175		SGE432
WR24X472		SU2104	2301	SU2301	SU2301	FR113		SU2102	GE176	SGE424	SGE432
WR24X473		SGE432	2302	SU2302	SU2302	FR115		SU2106	GE177		SGE432
WR24X474		SGE432	2303	SU2303	SU2303	FR116	SWC20	SU2101	GE391	SGE391	SGE422
WR24X481	SGE481		2304	SU2304	SU2304	FR117	SWC59	SU2103	GE437	SGE437	
WR24X484	SGE484		AD38	SAD38	SU2204	FR118	SWC60		GE446	SGE446	
WR24X485	SGE485		AD51		SU2204	FR119	SWC71		GE449	SGE449	
WR24X486	SGE486		AD52		SU2204	FR119	SWC41		GE450	SGE450	
WR24X490		SU2213	AD53		SU2204	FR122		SU2101	GE464	SGE464	SGE432
WR24X5001	SGE108	SGE433	AD54		SU2204	FR26	SWC26	SU2103	GE485	SGE485	SGE485
WR24X5002		SGE433	AD55		SU2204	FR90	SWC61	SU2103	GE52		SGE517
WR24X5006		SGE433	AD57		SU2002	GE 42		SGE517	GE5231	SGE5231	SGE433
WR24X5010		SU2213	AD63		SU2004	GE107	SGE107	SU2002	GE5232	SGE5232	SGE433
WR24X5011		SU2213	AD64		SU2002	GE108	SGE108	SGE433	GE55		SGE517
WR24X5013	SGE107	SU2002	AD65		SU2002	GE109		SGE433	GE558	SGE558	
WR24X5023		SU2003	AD67	SAD67	SU2101	GE110	SGE110	SGE433	GE57		SGE517
WR24X5024		SGE422	AD68	SAD68	SU2102	GE111	SGE111	SU2302	GE68		SU2002
WR24X5068		SGE422	AD69	SAD69	SU2101	GE112	SGE112	SU2301	GE69		SU2002
WR24X5070		SU2302	AD70	SAD70	SU2102	GE113		SU2301	GE71		SU2003
WR24X5071		SU2302	AD71	SAD71	SU2102	GE115		SU2301	GE72		SU2003
WR24X51		SU2102	AD72	SAD72	SU2102	GE116		SGE517	GE73		SU2002
WR24X5103		SU2003	AD73	SAD73	SU2104	GE117	SGE117	SGE517	GE75		SU2001
WR24X5104		SU2204	AD74		SU2102	GE118		SGE517	GE76		SGE517
WR24X5105		SU2304	AD76	SAD76	SU2004	GE119		SGE517	GE77		SU2002
WR24X5109		SGE433	AD77	SAD77	SU2204	GE120		SU2303	GE78		SGE517
WR24X5112	SGE108	SGE433	AD77	SAD81	SU2102	GE121		SU2213	GE79		SGE517
WR24X5113		SGE433	AD78		SU2204	GE125	SGE125	SU2302	GE81		SGE517
WR24X5114		SGE433	AD79	SAD79	SU2002	GE126	SGE126	SU2302	GE82		SGE517
WR24X5115	SGE110	SGE433	AD79	SAD83	SU2102	GE127	SGE127	SU2302	GE88		SGE517
WR24X5116		SGE433	AM22		SU2002	GE128	SGE301		GE94		SU2302
WR24X5118		SGE422	AM23		SU2004	GE129	SGE303	SU2302	GI30		SU2302
WR24X5119		SGE422	AM28		SU2301	GE130	SGE284		GI33		SU2302
WR24X5123		SGE433	AM29	SAM29	SU2213	GE132	SGE286		GI41		SU2102
WR24X5124		SGE422	AM30		SU2301	GE133	SGE318		GI42		SU2106
WR24X5125		SU2304	AM31		SU2302	GE134	SGE309		GI43	SGI47	SU2102
WR24X5126		SU2302	AM32	SAM32	SU2302	GE135	SGE319	SU2002	GI44	SGI46	SU2102
WR24X5133	SGE312	SU2301	CS25		SU2303	GE136	SGE390		KL34		SU2302
WR24X5134	SGE127	SU2302	CS26		SU2302	GE137	SGE433	SGE433	KL35		SU2302
WR24X5137		SU2301	CS27	SCS27	SU2302	GE138	SGE287		KL36	SKL36	SU2302
WR24X5140		SU2104	CS28		SU2301	GE139	SGE312	SU2301	KL37	SKL37	SU2301
WR24X5141		SU2104	CS29		SU2301	GE140		SU2301	KL56		SU2302
WR24X5144		SU2304	CS31		SU2303	GE141	SGE311	SU2302	KL57		SU2301
WR24X5148	SGE422	SGE422	CS32		SU2213	GE142	SGE422	SGE422	PH47		SU2213
WR24X5149		SGE422	CS33		SU2302	GE143		SGE517	PH48		SU2213
WR24X5150		SU2304	CS34		SU2302	GE144		SGE517	PH49		SU2213
WR24X517		SGE517	CS36		SU2301	GE146		SU2302	PH50		SU2301
WR24X518	SGE485	SGE485	CS37		SU2301	GE147		SU2301	PH52	SPH52	SU2301
WR24X5206		SGE421	CS40		SU2213	GE148		SU2106	PH53	SPH53	SU2302
WR24X5211		SGE433	CS41	SCS79	SU2304	GE151		SGE433	PH54		SU2302
WR24X5212		SGE433	CS42	SCS42	SU2302	GE152			PH55		SU2301
WR24X5215		SU2102	CS43	SCS92	SU2302	GE153	SGE295	SGE432	PH57		SU2302
WR24X5230		SGE433	CS44	SCS44	SU2213	GE155	SGE300	SGE432	WC12	SWC12	
WR24X5231	SGE5231	SGE433	CS46	SCS46	SU2302	GE156	SGE302	SGE433	WE55	SWE55	
WR24X5232	SGE5232	SGE433	CS47	SCS100	SU2302	GE157	SGE305	SGE432	WE58	SWE58	
WR24X5238		SU2102	CS49	SCS49	SU2302	GE158	SGE308	SGE421	WE70		SU2302
WR24X524	SGE524		CS50		SU2303	GE159		SU2106	WE71		SU2213
WR24X5256		SGE432	CS51	SCS98	SU2303	GE160	SGE389	SGE421	WE72		SU2301
WR24X5258		SGE433	CS52	SCS115	SU2303	GE161	SGE421	SGE421	WE73		SU2303
WR24X526		SGE433	CS53		SU2301	GE162	SGE432	SGE432	WP104		SU2301
WR24X5265		SU2304	CS54		SU2302	GE163		SU2102	WP13		SU2301
WR24X527		SGE433	CS55		SU2301	GE164		SGE433	WP16		SU2213
WR24X528	SGE528	SGE433	CS56	SCS116	SU2304	GE165		SGE433	WP16	SCS79	SU2304
WR24X550		SU2203	CS57	SCS102	SU2301	GE166		SGE433	WP17		SU2213
WR24X558	SGE558		CS58	SCS97	SU2304	GE167		SGE433	WP18	SCS92	SU2302









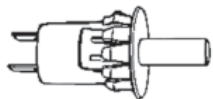
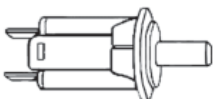
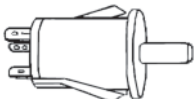

Refrigerator Door Gasket Cross Reference

Gemline (Cont.)			Maytag (Cont.)			Whirlpool (Cont.)			Whirlpool (Cont.)		
OEM No.	Supco No.	Universal Kit	OEM No.	Supco No.	Universal Kit	OEM No.	Supco No.	Universal Kit	OEM No.	Supco No.	Universal Kit
WP20		SU2213	66929-9		SU2204	1109187	SCS115	SU2303	2165383		SU2301
WP21	SCS105	SU2304	68543-3	SAD79	SU2003	1109188	SCS75	SU2303	2166000		SU2301
WP28	SCS93	SU2301	68543-4		SU2102	1110568	SCS93	SU2301	2166001		SU2301
WP31		SU2303	69348203		SU2204	1110569	SCS98	SU2303	2177230	SCS92	SU2302
WP32		SU2302	69351298		SU2204	1110648	SCS105	SU2304	2177232	SCS103	SU2302
WP33		SU2301	70025-1		SU2204	1110649	SCS116	SU2304	2177234		SU2302
WP449		SU2302	70025-2	SAD99	SU2002	1110658	SCS79	SU2304	2188404	SCS105	SU2304
WP566	SCS102	SU2301	70025-3		SU2204	1110659	SCS97	SU2304	2188405	SCS79	SU2304
WP567		SU2301	70025-4	SAD97	SU2002	1114800		SU2304	2188406	SCS79	SU2304
WP570	SCS100	SU2302	70025-5	SAD100	SU2001	1114820		SU2304	2191888	SCS112	SU2303
WP572	SCS92	SU2302	70025-6	SAD101	SU2002	1114822		SU2304	2191889		SU2301
WP577	SCS103	SU2302	70047-1	SAD67	SU2101	1114858		SU2304	4339427	SCS102	SU2301
WP589		SU2303	70047-2	SAD69	SU2101	1115314	SCS105	SU2304	4343266		SU2102
WP590	SCS46	SU2302	70047-3	SAD71	SU2102	1115315	SCS79	SU2304	4343267	SCS107	SU2102
WP591		SU2303	70047-4		SU2101	1116582	SCS99	SU2302	4387563		SU2301
WP608	SCS115	SU2303	70048-1	SAD68	SU2102	1116592	SCS100	SU2302	4387564		SU2301
WP609	SCS75	SU2303	70048-2	SAD70	SU2102	1116734	SCS99	SU2302	4387565	SCS93	SU2301
WP617	SCS79	SU2304	70048-3	SAD83	SU2102	1116735	SCS100	SU2302	4387566	SCS102	SU2301
WP622	SCS105	SU2304	70048-4	SAD73	SU2104	1118191	SCS116	SU2304	4387567		SU2302
WP626		SU2104	70048-5	SAD81	SU2102	1118192	SCS97	SU2304	4387568		SU2301
WP634	SCS97	SU2304	D3786409		SU2204	1119565		SU2302	4387570	SCS100	SU2302
WP638	SCS116	SU2304	D7092601Q		SU2213	1119568	SCS92	SU2302	4387572	SCS92	SU2302
WP99	SCS99	SU2302	D7092602Q	SAM29	SU2213	1122826	SCS115	SU2303	4387576		SU2302
			D7092603Q		SU2213	1122827	SCS75	SU2303	4387577	SCS103	SU2302
			D7092608Q	SAM41	SU2213	1122828		SU2302	4387580	SCS103	SU2302
			D7092609Q		SU2213	1122829	SCS102	SU2301	4387583		SU2302
			D7251001Q		SU2301	1122830		SU2302	4387588		SU2302
			D7251002Q		SU2304	1122831	SCS92	SU2302	4387589		SU2302
			D7251004Q		SU2301	1124971	SCS116	SU2304	4387590	SCS46	SU2302
			D7605105Q		SU2102	1124972	SCS97	SU2304	4387591		SU2302
			D7605106Q	SAM43	SU2102	1125147		SU2304	4387592		SU2302
			D7605107Q	SAM44	SU2102	1125886	SCS92	SU2302	4387602	SCS112	SU2303
			D7605108Q	SAM33	SU2102	1125887		SU2302	4387603	SCS99	SU2302
			D7605109Q	SAM34	SU2102	1125888	SCS100	SU2302	4387604	SCS99	SU2302
			D7605110Q	SAM35		1125889	SCS99	SU2302	4387605	SCS99	SU2302
			D7605115Q	SAM39	SU2102	1125924	SCS103	SU2302	4387607	SCS98	SU2303
			D7605116Q	SAM40	SU2102	1125926	SCS79	SU2304	4387608	SCS115	SU2303
			D7825205	SAM62	SU2106	1125927	SCS105	SU2304	4387609	SCS75	SU2303
			D7870905	SAM62	SU2106	1125928	SCS97	SU2304	4387611		SU2303
			D7870905Q	SAM62	SU2106	1125929	SCS116	SU2304	4387617	SCS79	SU2304
						1126756		SU2302	4387622	SCS105	SU2304
						1126762	SCS92	SU2302	4387623	SCS105	SU2304
						1127256	SCS103	SU2302	4387624	SCS105	SU2304
						1127307	SCS116	SU2304	4387626		SU2104
						1127308	SCS97	SU2304	4387627		SU2302
						1127309	SCS116	SU2304	4387628		SU2304
						1127310	SCS97	SU2304	4387630		SU2304
						1128059	SCS115	SU2303	4387632		SU2304
						1128060	SCS102	SU2301	4387634	SCS97	SU2304
						1128061	SCS98	SU2303	4387637	SCS97	SU2304
						1128064	SCS93	SU2301	4387638	SCS116	SU2304
						1128090		SU2304	4387639	SCS116	SU2304
						1128158		SU2304	4387641	SCS116	SU2304
						1129266	SCS105	SU2304	4387655	SCS100	SU2302
						1129267	SCS79	SU2304	481783		SU2213
						2147024	SCS103	SU2302	509361		SU2213
						2148043	SCS115	SU2303	509993		SU2213
						2148044	SCS102	SU2301	510256		SU2213
						2148270	SCS105	SU2304	511312		SU2213
						2148271	SCS79	SU2304	511399		SU2213
						2148565		SU2302	512270		SU2213
						2148567	SCS92	SU2302	512273		SU2213
						2150117	SCS75	SU2303	512274	SCS27	SU2213
						2150124		SU2302	520816		SU2213
						2160436	SCS103	SU2302	520817		SU2213
						2160438	SCS103	SU2302	520818		SU2213
						2160883	SCS103	SU2302	520819	SCS27	SU2213
						2162642	SCS112	SU2303	520820		SU2213

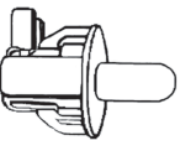
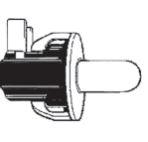
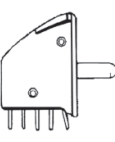
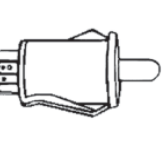
Refrigerator Door Gasket Cross Reference

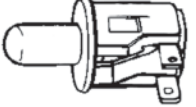
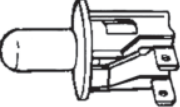
Whirlpool (Cont.)			Whirlpool (Cont.)			Whirlpool (Cont.)		
OEM No.	Supco No.	Universal Kit	OEM No.	Supco No.	Universal Kit	OEM No.	Supco No.	Universal Kit
520821		SU2213	839858		SU2302	986703	SCS92	SU2302
522042		SU2213	845281		SU2303	986704	SU2302	
522048		SU2213	845282		SU2213	986705	SU2302	
522056		SU2213	845283		SU2301	986706	SCS105	SU2304
522057		SU2213	845376		SU2303	986707	SCS116	SU2304
527103		SU2213	848394		SU2213	987036	SCS46	SU2302
527697		SU2213	849336		SU2303	987037	SCS100	SU2302
527698	SCS27	SU2213	849410		SU2303	987151	SCS46	SU2302
527699		SU2213	849462		SU2303	987152	SCS100	SU2302
527713		SU2213	912564		SU2302	987153	SU2302	
528225		SU2213	912565		SU2301	987154	SCS92	SU2302
528917		SU2213	935761	SCS115	SU2303	988497		SU2301
528918		SU2213	937001	SCS102	SU2301	991117		SU2302
530818		SU2213	939048	SCS115	SU2303	991143		SU2302
539898		SU2213	939049	SCS102	SU2301	992487	SCS92	SU2302
539902		SU2304	939341	SCS116	SU2304	992488		SU2104
553789		SU2213	939342	SCS97	SU2304	992582		SU2301
553839	SCS108	SU2213	939565	SCS105	SU2304	992741		SU2301
554478		SU2213	939566	SCS79	SU2304			
556226	SCS108	SU2213	939911		SU2302			
556227		SU2213	940162		SU2304			
556241	SCS108	SU2213	942256		SU2302			
556252		SU2213	942268	SCS115	SU2303			
556253	SCS108	SU2213	942271	SCS102	SU2301			
556256		SU2213	942287	SCS115	SU2303			
556292		SU2213	942289	SCS102	SU2301			
567329		SU2213	942299	SCS46	SU2302			
567897		SU2213	942674		SU2104			
567932		SU2213	942678		SU2302			
576399	SCS108	SU2213	942687		SU2304			
576400	SCS108	SU2213	942903	SCS100	SU2302			
581985	SCS108	SU2213	942931		SU2302			
592950	SCS111	SU2213	942933	SCS92	SU2302			
592951		SU2213	942964		SU2302			
653973		SU2213	943055		SU2302			
654025		SU2213	943057		SU2302			
654027		SU2213	943116	SCS105	SU2304			
654035		SU2301	943117	SCS79	SU2304			
654191		SU2304	943220	SCS105	SU2304			
654264		SU2213	943221	SCS79	SU2304			
654399		SU2213	943623		SU2304			
654470		SU2213	943981		SU2302			
654471		SU2213	943982	SCS92	SU2302			
654472		SU2213	944457	SCS116	SU2304			
655601		SU2304	944470	SCS97	SU2304			
655893		SU2213	944925	SCS98	SU2303			
728686	SCS111	SU2213	944948	SCS93	SU2301			
728688		SU2213	945061	SCS103	SU2302			
730393	SCS111	SU2213	945092		SU2301			
730414		SU2213	945832		SU2302			
730451	SCS111	SU2213	945833	SCS92	SU2302			
753080		SU2213	946802	SCS115	SU2303			
753081		SU2213	946803	SCS102	SU2301			
753440	SCS111	SU2213	946990	SCS115	SU2303			
836109		SU2302	946991	SCS75	SU2303			
836224		SU2302	946992	SCS115	SU2303			
836226		SU2301	946993	SCS75	SU2303			
836227	SCS92	SU2302	946994	SCS102	SU2301			
836228	SCS79	SU2304	946995		SU2302			
836356	SCS46	SU2302	946996	SCS102	SU2301			
836357	SCS100	SU2302	946997		SU2302			
836506		SU2301	9790369	SCS112	SU2303			
836507	SCS100	SU2302	981037		SU2302			
836508	SCS92	SU2302	981038		SU2302			
836509		SU2302	981092		SU2104			
836510	SCS46	SU2302	983644	SCS97	SU2304			
836511		SU2302	986016	SCS103	SU2302			
838141	SCS60	SU2213	986702		SU2302			

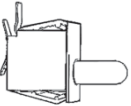
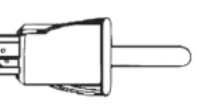
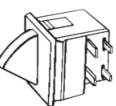
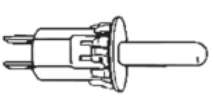
Switches

ES18100 Refrigerator/Freezer	ES18200 Refrigerator/Freezer	ES18300 Refrigerator/Freezer Fan	ES18500 Refrigerator / Freezer Fan & Light	ES18600 Refrigerator / Freezer Fan & Light
Easy snap in horizontal mount, with .250 push on terminals	Easy snap in horizontal mount, with .250 push on terminals	Easy snap in horizontal mount	White, Vertical mount 3 Terminal	Momentary contact Push on
Replaces: 18801, 188-1 Amps 1.5 / 4 amps	Replaces: 18200, 182 Amps 10 / 5 amps	Replaces: 18300, 183 Amps .75 / .25 amps	Replaces: 18500, 185 Amps .25 / .75 amps	Replaces:18600, 186 Amps 5 / 2.5 amps
Volts 125 / 250	Volts 125 / 250	Volts 125 / 250	Volts 125 / 250	Volts 125 / 250
Mount Snap in	Mount Snap in	Mount Threaded	Mount Threaded	Mount Snap in
				
ES18700 Domestic Commercial	ES18801 Domestic Commercial	ES18802 Refrigerator/Freezer Light	ES18803 Refrigerator/Freezer Fan & Light	ES18804 Refrigerator/Freezer Fan & Light
Universal door switch Gibson, Used on commercial walk ins	Color coded Red body fan switch. Used for 30 years	Color coded Black body light switch. Used for 30 years	White, Horizontal mount 4 Terminal, 2 circuit	White, Vertical mount 4 Terminal, 2 circuit
Replaces: 18700, 187	Replaces: 18801, 188-1	Replaces: 18802, 188-2	Replaces: 18803, 188-3	Replaces: 18804, 188-4
Amps .25 / .75 amps	Amps 5 / 2.5 amps	Amps 5 / 2.5 amps	Amps 5 / 2.5 amps	Amps 4 / .75 amps
Volts 125 / 250	Volts 125 / 250	Volts 125 / 250	Volts 125 / 250	Volts 125 / 250
Mount Threaded	Mount Snap in	Mount Snap in	Mount Snap in	Mount Snap in
				
ES18805 Refrigerator/Freezer Fan	ES18806 Refrigerator/Freezer Light	ES18809 Refrigerator/Freezer Fan	ES18810 Refrigerator/Freezer Light	ES18811 Refrigerator/Freezer Fan & Light
White Rectangular , Easy snap in design	White Rectangular , Easy snap in design	Easy installation	Easy installation	SPDT Heavy Duty Switch, typically used on GE Dishwashers, and others.
Replaces: 18805, 188-5	Replaces: 18806, 188-6	Replaces: 18809, 188-9	Replaces: 18810, 188-10	Replaces: 18811, 188-11
Amps 5 / 2.5 amps	Amps 5 / 2.5 amps	Amps 5 / 2.5 amps	Amps 5 / 2.5 amps	Amps 5 / 2.5 amps
Volts 125 / 250	Volts 125 / 250	Volts 125 / 250	Volts 125 / 250	Volts 125 / 250
Mount Snap in	Mount Snap in	Mount Snap in	Mount Snap in	Mount Snap in
				
ES18812 Refrigerator/Freezer Fan & Light	ES18813 Refrigerator / Freezer Fan & Light	ES18814 Refrigerator / Freezer Fan & Light	ES18815 Refrigerator / Freezer Light	ES18817 Refrigerator / Freezer Fan
3 Terminals	4 terminal	4 terminal	Longer shaft	Whirlpool 2149705
	Replaces:18813, 188-13 Amps 4 / 1.5 amps	Replaces:18814, 188-14 Amps 5 / 2.5 amps	Replaces:18815, 188-15 Amps 1/2 amps	Replaces:18817, 188-17 Amps 5 / 2.5 amps
Replaces: 18812, 188-12	Volts 125 / 250	Volts 125 / 250	Volts 125 / 250	Volts 125 / 250
Amps 10 amps	Mount Snap in	Mount Snap in	Mount Snap in	Mount Snap in
Volts 125 / 250				
Mount Snap in				
				

Valves & Fittings



SUD Series Copper Driers

SUPCO Copper Driers are high quality, high capacity original equipment components for use on both domestic and commercial refrigerators, freezers and air conditioners.

Features

- 100% XH-9 beaded molecular sieve
- Hermetically sealed
- Copper shells and end tubes
- High capacity
- Easy break off grooved ends

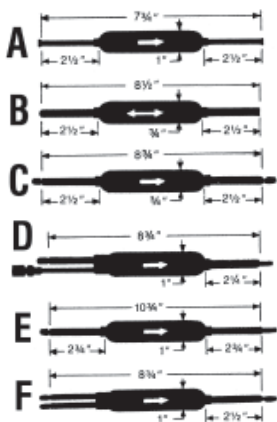

NOTE: All driers are compatible with all refrigerants.

PART NO.	DROPS OF WATER REMOVED				RECOMMENDED TONNAGE	
	R-12		R-22		R-12	R-22
	75°	125°	75°	125°		
SUD103	37.5	34	34	32	1/3	1/2
SUD109	37.5	34	34	32	1/3	1/2
SUD110	37.5	34	34	32	1/3	1/2
SUD111	74	68	68	64	3/4	1
SUD112	99	93	95	90	1	2
SUD113	74	68	68	64	3/4	1
SUD114	74	68	68	64	3/4	1
SUD115	37.5	34	34	32	1/3	1/2
SUD116	74	68	68	64	3/4	1

SUPCO Copper Extended Driers

PART NO.	DESCRIPTION	INLET	OUTLET	DIMENSIONS (SEE CHART)
SUD103	1" Plugged Ends	1/4" O. D.	1/4" O. D.	A
SUD109	3/4" Non-Directional	1/4" O. D.	1/4" O. D.	B
SUD110	3/4" Fused Ends	1/4" O. D.	1/4" O. D.	C
SUD111	1" Charging Drier	1/4" O.D. 1/4" Flare	1/4" O.D. or Cap	D
SUD112	1" Step Down Drier	5/16" O.D.	5/16" O.D. or Cap	E
SUD113	1" Double Inlet	(2)1/4" O. D.	1/4" O. D.	F
SUD114	1" Fused Ends	1/4" I.D. 1/4" O. D.	1/4" O.D. or Cap	G
SUD115	3/4" Charging Drier	1/4" I.D. 1/4" O. D. 1/4" Flare	1/4" O. D. or Cap	H
SUD116	1" Step Down Drier	3/16", 1/4", 5/16" I.D.	5/16" I.D. or Cap	J



VI2404 3/4" Brass Valve Adapter Icemaker/Humidifier

- 90° construction to relieve stress on tubing
- 3/4" MHT to 1/4" Compression
- Washer included
- Many icemaker valves require a 3/4" MHT connector
- All brass won't rust

BPV Series Bullet® Piercing Valves

The *ONLY* valve with a permanent type, patented gasket application!

SUPCO's "Bullet® Piercing Valve" utilizes the same type of gasket found under the head plate of most air conditioning compressors. When installed, the gasket actually compresses the copper tubing .020" creating a permanent, leakproof seal that will withstand any pressure and temperature for the life of the unit.

Features

- Patented valve gasket application provides 50 times more sealing area than competitive "O" ring types
- A sealing force of over 180 inch lbs., torque tested with 500 lbs., pressure tested at 250°F
- Precision piercing needle is engineered for concentricity and hardness to insure perfect seating every time
- Nonpositional mounting — No adapter valve required
- Requires only a 2" clearance area for installation and operation
- Hex key wrench included — No additional tools required
- Corrosion resistant plated and lacquered finish

Applications

- Install on the high side as a permanent valve on the job
- Install on round suction lines or uneven tubing

BPV SERIES BULLET® PIERCING VALVES		
PART NO.	O.D. TUBING SIZE	PACKAGING
BPV31*	1/4", 5/16", 3/8"	12/Box
BPV31D*	1/4", 5/16", 3/8"	48/Box
BPV21*	1/2", 5/8"	8/Box
BPV36	3/16"	12/Box
BPV14	1/4"	12/Box
BPV56	5/16"	12/Box
BPV38	3/8"	12/Box
BPV12	1/2"	8/Box
BPV58	5/8"	8/Box
BPV34	3/4"	1/Box
BPV78	7/8"	1/Box

*NOTE: BPV31 and BPV21 are furnished with adapter sleeves for indicated multiple use applications.

Valves & Fittings

Line Service Valves

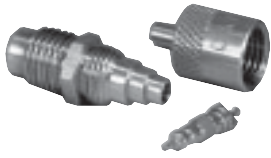

PART NO.	DESCRIPTION	PIPE THREAD	PART NO.	DESCRIPTION	PIPE THREAD
SF1010	1/8" copper tubing, wrench cap and core	—	SF3603	3/16" copper tubing, wrench cap and core	1/8" MIP
SF2525	1/4" copper tubing, wrench cap and core	—	SF3604	1/4" copper tubing, wrench cap and core	1/8" MIP
SF3600	1/8" ID hole, 3/16", 1/4", 5/16" steps, 1/8" MPT below hex wrench cap and core	—	SF3605	5/16" copper tubing, wrench cap and core	—
			SF3606	3/8" copper tubing, wrench cap and core	—
SF3602	1/4" copper tubing, 3/16" & 1/8" copper bushings, wrench cap and core	1/8" MIP	SF3608	1/8" copper tubing, wrench cap and core	1/8" MIP

SA Series Adjustable Line Tap Valves



Features

- Available in two sizes to accommodate five different OD tube sizes.
- Depressor valve action
- Can be mounted in any position
- Retracting needle ensures no restriction
- Throw away depressor pin simplifies line piercing
- Hex wrench included
- Adapter sleeves included
- Can be used with all refrigerants including R410A
- Maximum operating pressure 800 PSI
- Sold in 12 packs

Applications

- Used to provide access fitting without having to remove refrigerant from air conditioning, refrigeration and heat pump systems.

PART NO.	TUBE SIZE OD	REPLACES
SA1	1/4", 5/16", 3/8"	A1 Watsco, A1 Diversitech, QTM1
SA2	1/2", 5/8"	A2 Watsco, A2 Diversitech, QTM2

Valve Tools

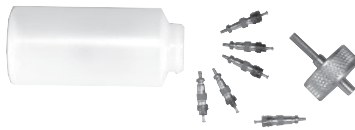

SF3800 Chaser

- Two tools, a core wrench and thread chaser, complete with a core carrying case and six cores
- Length with core wrench lid 3 1/2"

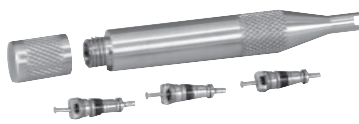

SF3813 Valve Core Remover / Container

- Heavy-duty, all brass
- Includes 3 valve cores
- Length is 3"



SF4311 "FasTap" Tube Piercing Pliers

Fast refrigerant recovery with pliers that clamp on and pierce tube. Pliers work on copper tubing sizes ranging from 1/4" to 7/8" OD. They are simple to use and light weight. Adjust pliers to proper size, align tip to the center of tube, clamp down and pierce with quick action. Piercing tip is self-sharpening, but also easily replaceable.

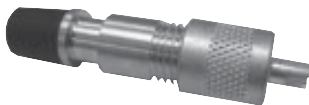

SF4314 Tube Piercing Pliers Replacement Tip

Condensate Drain Pans

70 Condensate Drain

Authorized, cost effective replacement drain for most commercial refrigerators and freezers.

Features/Benefits:

- PTC Control supplies only required heat to evaporate water.
- Thermostat and float NOT required
- Self regulating
- Uniform heating

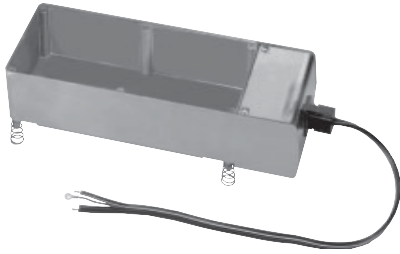

PART NO.	CAPACITY	VOLTS	WATTS	AMPS	EVAPORATE RATE	SIZE
70	50 OZ.	115	300	2.61	6 OZ./HR.	12 1/4" x 4 3/4" x 3"
70-220	50 OZ.	220	300	1.36	6 OZ./HR.	12 1/4" x 4 3/4" x 3"
70CSA*	50 OZ.	115	190	1.65	6 OZ./HR.	12 1/4" x 4 3/4" x 3"
70CSA220*	50 OZ.	220	190	.86	6 OZ./HR.	12 1/4" x 4 3/4" x 3"

*CSA indicates CSA approval. ** All are 50/60 HZ

30-OS, 31 & 75 Condensate Drains

- Standard cast aluminum condensate drains complete with long life heating element and mounting legs.
- Designed for continuous use.



PART NO.	CAPACITY	VOLTS	WATTS	AMPS	EVAPORATE RATE	SIZE
30-OS*	38 OZ.	120	160	1.33	8 OZ./HR.	10" x 4" x 2 7/8"
30-220-OS*	38 OZ.	220	160	.73	8 OZ./HR.	10" x 4" x 2 7/8"
31	50 OZ.	120	160	1.33	6 OZ./HR.	10" x 4 1/2" x 3 3/8"
31-220	50 OZ.	220	160	.73	6 OZ./HR.	10" x 4 1/2" x 3 3/8"
75	75 OZ.	120	320	2.67	14 OZ./HR.	10" x 9" x 2 3/4"
75-220	75 OZ.	220	320	1.45	14 OZ./HR.	10" x 9" x 2 3/4"

* Indicates NSF listing ** All are 50/60 HZ

Wall Mount Brackets

PART NO.	CONDENSATE DRAIN NO.
30WM	30-OS Series, 70 Series
31WM	31 Series

Defrost Heaters

SH200 Series Flexible Braided Aluminum Drain Heat

Designed for continuous use to protect drains from ice build up. Heaters are offered in a variety of lengths and wattages.

Applications

- Domestic and Commercial Refrigeration
- Air Conditioning and Heat Pump Systems
- Condensate Drain Pans, Tubes, and Troughs

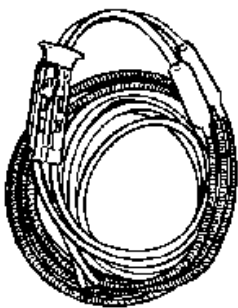

Supco Part No.	Watts	Volts	Heated Length	Leads	Mars No.	Gemline No.
SH201	15	115	18"	23"	34121	GH201
SH202	45	115	29"	23"	34122	GH202
SH203	55	115	44"	23"	34123	GH204
SH204	75	115	48"	23"	34124	GH203
SH205	65	115	56"	23"	34125	GH205
SH206	80	115	70"	23"	34126	GH206
SH207	110	115	86"	23"	34127	GH207

Defrost Heaters

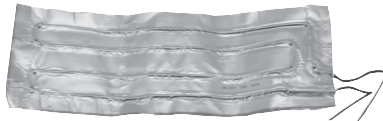

SH220 Series Aluminum Foil Heaters

Features and Benefits

- Pressure Sensitive Adhesive Backing
- Assorted Shapes
- Assorted Wattages

Applications

- Domestic and Commercial Refrigeration
- Drain Pans
- Drain Troughs
- Mullions
- Spot Heating

Supco Part No.	Watts	Volts	Size	Mars No.	Gemline No.
SH221	6	115	10" X 1"	34111	GH221
SH222	10	115	24" X 1 1/4'	34112	GH222
SH223	10	115	14 1/2" X 5 1/2"	34113	GH223
SH224	65	115	27 1/2" X 5 1/2"	34114	GH224
SH225	15	115	10 1/2" X 10 1/2"	34115	GH225
SH226	40	115	10 1/2" X 10 1/2"	34116	GH226



SH251 Universal Silicone Drain Heater

A 7 1/2" silicone tip drain heater designed to fit in the drain opening. The SH251 is wired in series only, applying low wattage heat when the drain heater or defrost heater is on. Rated at 8 watts to be wired in series in a 110 to 120 volt circuit. Replaces GE WR51X72, Electrolux 6582706, and Mars 34171.



SH280 Series Mullion and Dewpoint Door Heaters

Features and Benefits

- Prevents Moisture on Glass Display Doors
- Eliminates Moisture and Frost Build Up On Doors and Cabinet Fronts

Applications

- Domestic and Commercial Refrigeration
- Drain Pans and Troughs
- Mullions
- Spot Heating

Supco Part No.	Watts	Volts	Size	Gemline No.
SH281	6	115	10" X 1"	GH281
SH282	10	115	24" X 1 1/4'	GH282
SH283	10	115	14 1/2" X 5 1/2"	GH283
SH284	65	115	27 1/2" X 5 1/2"	GH284



SH500 Series Drain Heaters

Designed for continuous use to protect drains from ice build up. Heaters are offered in a variety of lengths, voltages, and wattages.













Applications

- Domestic and Commercial Refrigeration
- Air Conditioning and Heat Pump Systems
- Condensate Drain Pans, Tubes, and Troughs
- 120V and 240 V heaters

Supco Part No.	Watts	Volts	Heated Length	Leads
SH500	11	120	9"	18"
SH502	15	120	13"	18"
SH503	15	240	13"	18"
SH504	25	120	21"	18"
SH505	25	240	21"	18"

Defrost Heaters





Universal Replacement Glass Defrost Heaters

SH261	SH263	SH264	SH265
			
550 Watts 115 Volts Glass Length 21 3/16" Overall Length 21 15/16"	630 Watts 115 Volts Glass Length 21 5/8" Overall Length 22 3/8"	550 Watts 115 Volts Glass Length 8 1/2" Overall Length 9 1/4"	625 Watts 115 Volts Glass Length 10 5/8" Overall Length 11 3/8"
Single Tube GE Style Supports incld.	Single Tube GE Style Supports incld.	Two Series Tubes GE Style Supports incld.	Two Series Tubes
SH266	SH267	SH270	SH271
			
525 Watts 115 Volts Glass Length 21 5/8" Overall Length 22 9/16"	500 Watts 115 Volts Glass Length 22 13/16" Overall Length 23 13/16"	550 Watts 115 Volts Glass Length 24 1/4" Overall Length 25"	600 Watts 115 Volts Glass Length 8" Overall Length 8 3/4"
Single Tube	Single Tube	Single Tube	Two Series Tubes GE Style Supports incld.
SH273	SH274	SH276	SH277
			
775 Watts 115 Volts Glass Length 8" Overall Length 8 3/4"	480 Watts 115 Volts Glass Length 9" Overall Length 9 3/4"	550 Watts 115 Volts Glass Length 10 5/8" Overall Length 11 3/8"	440 Watts 115 Volts Glass Length 22 7/8" Overall Length 23 5/8"
Three Series Tubes GE Style Supports incld.	Two Series Tubes	Two Series Tubes GE Style Supports incld.	Single Tube

Defrost Heaters





Exact Replacement Defrost Heaters

Electrolux



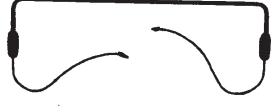

5309956756 SH278	5300158066 SH445	5303001362 SH419	5308009754 SH457
Glass / Vycor / Quartz 	Stainless Steel / Incoloy 	Stainless Steel / Incoloy 	Stainless Steel / Incoloy 
530 Watts Glass Length 20 1/2" Overall Length 22 1/2"	500 Watts Dimensions 23" X 5 1/2"	425 Watts Dimensions 20 1/4" X 3 1/8"	400 Watts Dimensions 20 1/4" X 3 1/8"

Electrolux

General Electric

5317842502 SH439	6490-099-1K SH415	WR49X390 SH305	WR49X391 SH303
Stainless Steel / Incoloy 	Stainless Steel / Incoloy 	3 tubes use old bracket 	Glass / Vycor / Quartz 
475 Watts Dimensions 22 3/4" X 5 1/2"	440 Watts Dimensions 20 1/4" X 6 1/8"	785 Watts Glass Length 8 1/4" Groove Width 7 11/16" Overall Length 9 5/8" Reference: WR49X5086	615 Watts Overall Length 9 3/4" 2 tubes brackets included Reference: WR49X249

General Electric





WR49X392 SH306	WR51X133 SH302	WR51X411 SH307	WR51X412 SH301
Glass / Vycor / Quartz 	Glass / Vycor / Quartz 	use old bracket 	Glass / Vycor / Quartz 
775 Watts Overall Length 12 1/2" 2 tubes brackets included Reference: WR49X250	620 Watts Glass Length 21 7/8" Overall Length 22 5/8"	425 Watts Glass Length 22 1/8" Groove Width 21 1/2" Overall Length 23 7/16" Reference: WR49X194	525 Watts Glass Length 21 3/16" Groove Width 20 5/8" Overall Length 22 5/8" Reference: WR49X169

Part numbers and illustrations are intended solely for identification. Items offered for sale are not represented to be manufactured by the company that built the original model.





Defrost Heaters

Exact Replacement Defrost Heaters



General Electric

WR51X413 SH308	WR51X442 SH309	WR51X443 SH310	WR51X464 SH464
Glass / Vycor / Quartz	Glass / Vycor / Quartz	Glass / Vycor / Quartz	Stainless Steel / Incoloy
			
450 Watts Glass Length 13 7/16" Overall Length 15 1/4"	600 Watts Overall Length 9 1/2" 2 tubes brackets included	772 Watts Overall Length 12 13/16" 2 tubes brackets included	400 Watts Dimensions 21 1/2" X 4"
			Reference: WR51X367

Maytag

52763-9 SH277	60106-34 SH319	60106-35 SH320	60106-36 SH326
Glass / Vycor / Quartz	Glass / Vycor / Quartz	Glass / Vycor / Quartz	Glass / Vycor / Quartz
			
440 Watts Glass Length 22 7/8" Overall Length 23 5/8"	400 Watts Glass Length 17 1/4" Overall Length 18"	450 Watts Glass Length 19 5/8" Overall Length 20 7/16"	450 Watts Glass Length 21 1/4" Overall Length 22"
Reference: 52763-7	Reference: 60106-19	Reference: 60106-14	For 1200029 Kit order SH326 & SL8528









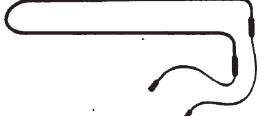

Maytag

61001846 SH311	61001874 SH374	12001027 SH327 Kit	D7549703 SH437
Glass / Vycor / Quartz	Glass / Vycor / Quartz	Glass Heater with T'Stat	Stainless Steel / Incoloy
			
685 Watts Overall Length 15 1/4"	620 Watts Overall Length 12"	400 Watts Glass Length 17 1/4" Overall Length 18"	500 Watts
Two Series Tubes Reference: 52764-14	Two Series Tubes Reference: 52764-15	12001027 Kit includes heater & SL8528	Dimensions 24 3/4" X 4" Reference: D7549701

Part numbers and illustrations are intended solely for identification. Items offered for sale are not represented to be manufactured by the company that built the original model.

Defrost Heaters

Exact Replacement Defrost Heaters

Maytag		Whirlpool	
R0157335 SH416 Icemaker Mold Heater  165 Watts 120 Volts Dimensions 10" X 2 3/4" Reference: 625843, 625893	1105164 SH447 Stainless Steel / Incoloy  425 Watts 120 Volts Dimensions 20 7/8" x 5" Reference: 942870	549433 SH433 Stainless Steel / Incoloy  650 Watts 120 Volts Dimensions 15 3/8" x 7 5/8" Reference: 9344452	851363 SH442 Stainless Steel / Incoloy  775 Watts 120 Volts Dimensions 18 5/8" x 9 5/16" Reference: 989607
Whirlpool			
851631 SH443 Stainless Steel / Incoloy  515 Watts 120 Volts Dimensions 23 5/8" X 5 3/4" Reference: 989590	851789 SH434 Stainless Steel / Incoloy  650 Watts 120 Volts Dimensions 25 5/8" X 7 1/4" Reference: 989612	935798 SH432 Stainless Steel / Incoloy  475 Watts 120 Volts Dimensions 22" X 6 1/2" Reference: 9344452	936129 SH448 Stainless Steel / Incoloy  625 Watts 120 Volts Dimensions 24 7/8" X 7 5/8" Reference: 851778
Whirlpool			
937302 SH431 Stainless Steel / Incoloy  600 Watts 120 Volts Dimensions 23" X 7 3/4" Reference: 9344452	978331 SH413 Stainless Steel / Incoloy  650 Watts 120 Volts Dimensions 23 5/8" X 6 1/2" Reference: 549393	978945 SH414 Stainless Steel / Incoloy  650 Watts 120 Volts Dimensions 26 5/8" X 6 1/4" Reference: 549392	978495 SH429 Stainless Steel / Incoloy  500 Watts 120 Volts Dimensions 25 1/4" X 3 1/4" Reference: 548029

Part numbers and illustrations are intended solely for identification. Items offered for sale are not represented to be manufactured by the company that built the original model.

Heaters Cross Reference

Electrolux			Gemline (Cont.)			General Electric (Cont.)			Mars			Maytag (Cont.)			Maytag (Cont.)		
OEM No.	Supco No.		OEM No.	Supco No.		OEM No.	Supco No.		OEM No.	Supco No.		OEM No.	Supco No.		OEM No.	Supco No.	
08000061	SH439	D	GH272	SH272	U	WR51X188	SH303	D	34151	SH261	U	52763-9	SH267	U	61002046	SH267	U
08000745	SH419	D	GH273	SH273	U	WR51X188	SH271	U	34152	SH262	U	52764-1	SH311	D	625843	SH416	D
08004171	SH419	D	GH274	SH274	U	WR51X192	SH306		34153	SH263	U	52764-1	SH264	U	628943	SH416	D
08009564	SH439	D	GH275	SH275	U	WR51X192	SH276	U	34154	SH264	U	52764-14	SH311	D	67679-1	SH311	D
08009754	SH457	D	GH276	SH276	U	WR51X194	SH307	D	34155	SH265	U	52764-14	SH264	U	67679-1	SH264	U
28-08-00200-001	SH270	U	GH277	SH277	D	WR51X202	SH303	D	34156	SH266	U	52764-15	SH374	D	67679-2	SH374	D
28-08-00200-004	SH271	U	GH277	SH267	U	WR51X202	SH271	U	34157	SH267	U	52764-15	SH265	U	69848-1	SH311	D
3001362	SH419	D	GH278	SH278	D	WR51X231	SH303	D	34158	SH268	U	52764-18	SH265	U	69848-1	SH264	U
3001466	SH439	D	GH301	SH301	D	WR51X231	SH271	U	34159	SH269	U	52764-22	SH311	D	69848-11	SH311	D
3001529	SH457	D	GH302	SH302	D	WR51X258	SH306	D	34160	SH270	U	52764-22	SH264	U	69848-11	SH264	U
5300158066	SH445	D	GH303	SH303	D	WR51X258	SH276	U	34161	SH271	U	52764-2	SH265	U	69848-12	SH374	D
5303001362	SH419	D	GH304	SH304	D	WR51X319	SH464	D	34162	SH272	U	52764-3	SH268	U	69848-12	SH374	D
5308009754	SH457	D	GH305	SH305	D	WR51X342	SH309	D	34163	SH273	U	52764-4	SH269	U	69848-2	SH374	D
5309956756	SH278	D	GH306	SH306		WR51X343	SH309	D	34164	SH274	U	52764-5	SH265	U	77284-2	SH261	U
5317842502	SH439	D	GH307	SH307	D	WR51X344	SH310	D	34166	SH276	U	52764-6	SH311	D	77284-2	SH261	U
53839	SH439	D	GH319	SH319	D	WR51X345	SH310	D	34175	SH415	D	52764-6	SH264	U	77284-3	SH277	D
623288	SH274	U	GH320	SH320	D	WR51X349	SH309	D	34177	SH419	D	52764-64	SH311	D	77284-3	SH267	U
623528	SH275	U	GH413	SH413	D	WR51X350	SH309	D	34179	SH429	D	52764-64	SH264	U	D7549701	SH437	D
625331	SH264	U	GH414	SH414	D	WR51X365	SH365	D	34181	SH413	D	52764-8	SH311	D	D7549703	SH437	D
6490-084-02	SH270	U	GH415	SH415	D	WR51X367	SH464	D	34182	SH414	D	52764-8	SH264	U	R0157335	SH416	D
6490-084-04	SH266	U	GH419	SH419	D	WR51X371	SH309	D	34188	SH303	D	52764-9	SH265	U	RA95043-1	SH311	D
6490-084-06	SH267	U	GH429	SH429	D	WR51X372	SH310	D	34189	SH305	D	52784-2	SH265	U	RA95043-1	SH264	U
6490-084-08	SH261	U	General Electric			WR51X404	SH309	D	34190	SH306		60106-1	SH319	D	Whirlpool		
6490-084-09	SH267	U	OEM No.	Supco No.	WR51X411	SH307	D	34191	SH307	D	60106-13	SH319	D	OEM No.	Supco No.		
6490-099-1K	SH415	D	WR49X207	SH303	D	WR51X412	SH301	D	34194	SH319	D	60106-14	SH320	D	548029	SH429	D
6599346	SH274	U	WR49X20	SH271	U	WR51X412	SH261	U	34195	SH320	D	60106-15	SH326	D	548030	SH429	D
6599348	SH275	U	WR49X20	SH304	D	WR51X413	SH308	D	34196	SH278	D	60106-17	SH320	D	548635	SH414	D
7546737	SH266	U	WR49X23	SH303	D	WR51X425	SH464	D	34197	SH301	D	60106-19	SH319	D	548645	SH413	D
86486	SH419	D	WR49X23	SH271	U	WR51X430	SH464	D	34198	SH302	D	60106-2	SH320	D	549392	SH414	D
86586	SH457	D	WR49X24	SH303	D	WR51X442	SH309	D	34199	SH304	D	60106-20	SH320	D	549393	SH413	D
9956756	SH278	D	WR49X243	SH271	U	WR51X443	SH310	D	Maytag			60106-21	SH326	D	549418	SH433	D
G000158066	SH445	D	WR49X249	SH303	D	WR51X447	SH464	D	OEM No.	Supco No	60106-23	SH320	D	549433	SH433	D	
G158056	SH445	D	WR49X24	SH271	U	WR51X461	SH310	D	0054628	SH416	D	60106-25	SH319	D	625963	SH416	D
G158066	SH445	D	WR49X25	SH306	D	WR51X463	SH309	D	12001027	SH327	D	60106-26	SH320	D	850535	SH433	D
G162431	SH439	D	WR49X25	SH276	U	WR51X464	SH464	D	29815-1	SH311	D	60106-27	SH326	D	851363	SH442	D
G162431-01	SH439	D	WR49X390	SH305	D	WR51X5002	SH272	U	29815-1	SH264	U	60106-28	SH319	D	851631	SH443	D
G162431-02	SH439	D	WR49X390	SH273	U	WR51X5003	SH272	U	43218	SH416	D	60106-29	SH320	D	851778	SH448	D
G162432-01	SH419	D	WR49X391	SH303	D	WR51X5018	SH305	D	52353-1	SH267	U	60106-3	SH326	D	851789	SH434	D
G162432-02	SH419	D	WR49X391	SH271	U	WR51X5018	SH273	U	52530-1	SH311	D	60106-30	SH326	D	934445	SH433	D
G176807-01	SH457	D	WR49X392	SH306	D	WR51X5024	SH261	U	52530-1	SH264	U	60106-32	SH320	D	935798	SH432	D
G178425-01	SH439	D	WR49X392	SH276	U	WR51X5036	SH261	U	52530-2	SH265	U	60106-34	SH319	D	936129	SH448	D
G178425-02	SH439	D	WR49X5086	SH305	D	WR51X5144	SH305	D	52530-2	SH265	U	60106-35	SH320	D	937302	SH431	D
Gemline			WR49X5086	SH273	U	WR51X5144	SH273	U	52530-6	SH311	D	60106-36	SH326	D	942870	SH447	D
OEM No.	Supco No.	WR49X5088	SH306	D	WR51X5145	SH305	D	52530-6	SH264	U	60106-38	SH320	D	978331	SH413	D	
GH261	SH261	U	WR49X5088	SH276	U	WR51X5145	SH273	U	52763-1	SH277	D	60106-40	SH320	D	978332	SH414	D
GH262	SH262	U	WR49X5106	SH306	D	WR51X5150	SH305	D	52763-1	SH267	U	60106-41	SH320	D	978495	SH429	D
GH263	SH263	U	WR49X5106	SH276	U	WR51X5150	SH273	U	52763-10	SH261	U	60106-44	SH320	D	989590	SH443	D
GH264	SH264	U	WR51X10002	SH464	D	WR51X5167	SH306	D	52763-16	SH261	U	61001139	SH311	D	989607	SH442	D
GH265	SH265	U	WR51X107	SH261	U	WR51X5167	SH276	U	52763-17	SH267	U	61001139	SH264	U	989612	SH434	D
GH266	SH266	U	WR51X133	SH302	D	WR51X5172	SH306	D	52763-3	SH267	U	61001140	SH374	D	989698	SH429	D
GH267	SH267	U	WR51X133	SH263	U	WR51X5172	SH276	U	52763-5	SH261	U	61001846	SH311	D			
GH268	SH268	U	WR51X152	SH262	U				52763-7	SH277	D	61001846	SH264	U			
GH269	SH269	U	WR51X169	SH301	D				52763-7	SH267	U	61001874	SH374	D			
GH270	SH270	U	WR51X183	SH303	D				52763-8	SH261	U	61002045	SH261	U			
GH271	SH271	U	WR51X183	SH271	U				52763-9	SH277	D	61002046	SH277	D			

Defrost Thermostats



SL45

ML and SL Series Defrost Thermostats

Metal case with water proof epoxy potting
 Heavy Duty Rating 10 Amps @ 120 Volts / 5 Amps @ 240 Volts
 Common Temperature Ranges
 Typically used for Residential and Commercial Applications
 Switching is SPST and can accommodate up to 1200 Watts.

Supco No. 12" Leads	Supco No. 24" Leads	Open °F	Close °F	Diff. °F	Mars	Uniline	
	ML37	37	47	10
SL45	ML45	45	25	20	33008	31-001	17001
SL50	ML50	50	30	20	33009	31-002	17003
SL55	ML55	55	35	20	33010	31-003	17005
SL60	ML60	60	40	20	33011	31-004	17007
SL70	ML70	70	50	20	33012	31-005	17009
SL80	ML80	80	30	50	33020	31-006	17011
SL90	ML90	90	35	55	33021	31-007	17013



SL243

Mounting Clips

Supco No.	Style
SL243	Surface / Flush Mounting Clip
SL245	Push In Mounting Clip
SL247	5/16" or 3/8" Around Tube Clip
SL249	Side Push on Tube Clip
SL250	Kit one of each style



SL245



SL247



SL249

SLT Series Residential and Commercial Defrost Thermostats

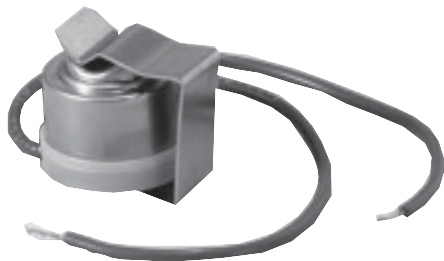

SLT45

Metal case with water proof epoxy potting
 Heavy Duty Rating 10 Amps @ 120 Volts / 5 Amps @ 240 Volts
 Typically used for Residential and Commercial Applications
 Switching is SPST and can accommodate up to 1200 Watts.
 Tube mounting clip attached to thermostat.
 Common Temperatures for tube mount applications.
 Direct Replacement for many commercial applications.

Supco No.	Open °F	Close °F	Diff. °F
SLT45	22	45	23
SLT50	10	50	40
SLT55	25	55	30
SLT60	30	60	30

Defrost Thermostats

Direct Replacement Defrost Thermostats



Style A



Style B



Style C



Style D



Style E



Style F



Style G

Electrolux							
Brand	Replaces: OEM No.	Exact Supco No.	Mounting Clip	Open °F	Close °F	Diff. °F	Style
Electrolux	5300460792	SL6792	Use Old Clip	75	25	50	F
	5303917625	SL2690	Around Tube	47	22	25	B
	5303917954	SL2691	3 Clip Kit	55	20	35	H
	5303917626	SL2691	3 Clip Kit	55	20	35	H
	5303917627	SL2691	3 Clip Kit	55	20	35	H
	5303917629	SL2691	3 Clip Kit	55	25	30	H
	F112205	SL2205	Side Tube Clip	50	10	40	D
F88366	SL8366	Snap on	60	20	40	E	

General Electric							
Brand	Replaces: OEM No.	Exact Supco No.	Mounting Clip	Open °F	Close °F	Diff. °F	Style
GE	WR49X430	SL5430	Side Tube Clip	130	120	10	D
	WR50X10010	SL10010	3/8" Tube	55	25	30	A
	WR50X112	SL50112	3/8" Tube	72	28	44	A
	WR50X122	SL50122	3/8" Tube	60	28	32	A
	WR50X124	SL50124	1/2" Tube	72	28	44	A
	WR50X129	SL50129	3/8" Tube	50	20	30	A
	WR50X134	SL50134	1/2" Tube	63	23	40	A

Maytag							
Brand	Replaces: OEM No.	Exact Supco No.	Mounting Clip	Open °F	Close °F	Diff. °F	Style
Maytag	10442411	SL2691	3 Clip Kit	55	20	35	H
	10544002	SL2690	Around Tube	47	22	25	B
	52085-1	SL8513	Snap on	45	25	20	E
	52085-10	SL8510	Snap on	40	10	30	E
	52085-11	SL8515	Snap on	55	15	40	E
	52085-12	SL8366	Snap on	60	20	40	E
	52085-13	SL8513	Snap on	45	25	20	E
	52085-15	SL8515	Snap on	55	15	40	E
	52085-17	SL8517	Side Tube Clip	80	15	65	D
	52085-19	SL8519	Side Tube Clip	80	31	49	D
	52085-2	SL8513	Snap on	45	25	20	E
	52085-20	SL8509	Snap on	40	15	25	E
	52085-28	SL8528	Snap on	47	15	32	E
	52085-29	SL8513	Snap on	45	25	20	E
	52085-3	SL8515	Snap on	55	15	40	E
	52085-30	SL8517	Side Tube Clip	80	15	65	D
	52085-5	SL8509	Snap on	40	15	25	E
	52085-6	SL8515	Snap on	55	15	40	E
	52085-9	SL8509	Snap on	40	15	25	E
	60413-4	SL8517	Side Tube Clip	80	15	65	D
	C3686602	SL8366	Snap on	60	20	40	E
	C3686604	SL8366	Snap on	60	20	40	E
	C8765001	SL50134	1/2" Tube	63	23	40	A
	C8765002	SL10010	3/8" Tube	55	25	30	A
	C8770402	SL8513	Snap on	45	25	20	E
	C8871201	SL2691	3 Clip Kit	55	20	35	H
	C8871201	SL2691	3 Clip Kit	55	20	35	H
	C8898603	SL2691	3 Clip Kit	55	20	35	H
	C8972003	SL2690	Around Tube	47	22	25	B
	C8972006	SL2690	Around Tube	47	22	25	B
	C8972006	SLT45	Side Tube Clip	45	22	23	D
	R0161086	SL2690	Around Tube	47	22	25	B

Defrost Thermostats

Direct Replacement Defrost Thermostats



Style H
Includes: SL243, SL245,
and SL247

Whirlpool							
Brand	Replaces: OEM No.	Exact Supco No.	Mounting Clip	Open °F	Close °F	Diff. °F	Style
Whirlpool	482290	SL2697	Side Push On	70	12	58	C
	2196155	SL6155	3/8" Tube	45	15	30	A
	4387489	SL3084	Use Old Clip	50	25	25	G
	4387490	SL7490	5/16" Tube	48	18	30	A
	4387500	SL7500	3/8" Tube	72	28	44	A
	4387503	SL7503	5/16" Tube	44	18	26	A

Commercial Refrigeration Defrost Thermostats Exact Replacement



SL5708

Brand	Replaces: OEM No.	Exact Supco No.	Mounting Clip	Open °F	Close °F	Diff. °F	Switching
Bohn	4725C	SL5708	Flush Mount	75	40	35	SPST
	4751C	SL5709	Flush Mount	55	35	20	SPDT
Russell	103079002	SL79002	Around Tube	55	30	25	SPST
	103079005	SL79005	Flush Mount	65	30	35	SPDT



SL5709



SL79002



SL79005

Humidifier Defrost/Freeze Protection Thermostat



SFPC

Brand	Replaces: OEM No.	Exact Supco No.	Mounting Clip	Open °F	Close °F	Diff. °F	Switching
Amana	R0161056	SFPC	Up to 7/8" Tube	35	50	15	SPST
Electrolux	5303304035	SFPC	Up to 7/8" Tube	35	50	15	SPST
	5303279149	SFPC	Up to 7/8" Tube	35	50	15	SPST
	5303323233	SFPC	Up to 7/8" Tube	35	50	15	SPST
	5304402782	SFPC	Up to 7/8" Tube	35	50	15	SPST
Trol A Temp	FPC	SFPC	Up to 7/8" Tube	35	50	15	SPST

Often used as a Universal Freeze Protection Thermostat.

Defrost Thermostats Cross Reference

Electrolux		Electrolux (Cont)		Electrolux (Cont)		Electrolux (Cont)		General Electric (Cont)	
OEM No.	Supco No.	OEM No.	Supco No.	OEM No.	Supco No.	OEM No.	Supco No.	OEM No.	Supco No.
00620901	SL50	5300460793	SL60	5604-18-6	SL60	G162690	SL2690	WR50X101	SL60
00621008	SL50	5300629464	SL50	5604-19-2	SL5844	G162690-01	SL2690	WR50X102	SL55
00622609	SL50	5301228589	SL50	5604-20-3	SL45	G162690-01	SL2691	WR50X103	SL55
00627316	SL50	5301230220	SL60	5604-23-1	SL45	G162697-01	SL2690	WR50X105	SL45
00627878	SL50	5303007540	SL2690	5604-23-2	SL45	G162697-01	SL2691	WR50X107	SL60
00628046	SL50	5303015195	SL2691	5604-23-4	SL45	G166153	SL2690	WR50X109	SL45
00629464	SL50	5303015865	SL55	5604-23-5	SL2690	G166157	SL2690	WR50X11	SL60
01135288	SL50	5303202296	SL50	86498	SL2690	G185196	SL2690	WR50X110	SL60
01136916	SL50	5303209818	SL55	C000048426	SL60	G189055-01	SL2690	WR50X111	SL60
06540457	SL50	5303211289	SL2691	C000048430	SL60	G191652	SL2690	WR50X115	SL60
06565294	SL50	5303211396	SL2690	C000048432	SL60	K1167822	SL50	WR50X117	SL55
06582737	SL50	5303279149	SL2691	C000048621	SL60	K1227771	SL50	WR50X119	SL50129
06585546	SL50	5303279266	SL2691	C000048623	SL60	K1228589	SL50	WR50X12	SL50
06595156	SL50	5303283296	SL2690	C000048625	SL60	K1229270	SL60	WR50X122	SL50122
06595294	SL50	5303300820	SL2690	C000048727	SL60	K1229271	SL60	WR50X125	SL60
06595363	SL50	5303300829	SL2691	C000048729	SL60	K1230220	SL60	WR50X127	SL50129
06599538	SL2690	5303300840	SL2691	C000048731	SL60	K1231024	SL60	WR50X128	SL50122
07511940	SL50	5303300853	SL2691	C000074249	SL60	K1231538	SL60	WR50X129	SL50129
07512366	SL50	5303308266	SL2691	C000074389	SL60	K1231624	SL60	WR50X13	SL50
07513645	SL50	5303308291	SL2691	C000289135	SL60	K1231688	SL60	WR50X14	SL50
07516267	SL50	5303309908	SL50	C000289245	SL60	R000900749	SL2690	WR50X15	SL50
07516378	SL50	5303309910	SL55	C000289247	SL60	W2656D44H04	SL50	WR50X16	SL45
07516659	SL50	5303309911	SL60	C000289249	SL60	W2656D44H09	SL50	WR50X17	SL60
07546170	SL50	5303311375	SL45	C000289313	SL60	A000254401	SL70	WR50X18	SL50
08000073	SL2690	5303311376	SL70	C000289315	SL60	A000269903	SL70	WR50X19	SL5022
08003827	SL50	5303912558	SL50	C000289316	SL60	A000286103	SL70	WR50X20	SL50
08011166	SL2690	5303917626	SL2690	C000289317	SL60	C000048728	SL6792	WR50X21	SL60
08014146	SL2691	5303917627	SL2690	C000289318	SL60	C000289135	SL60	WR50X22	SL5022
08017563	SL2690	5303917628	SL50	C000289321	SL60	C000289239	SL6792	WR50X23	SL60
1135288	SL55	5303917629	SL55	C000289323	SL60	C000289241	SL6792	WR50X24	SL50
1135693	SL90	5303917630	SL60	C000289318	SL60	C000289243	SL6792	WR50X25	SL45
116136	SL50	5303917954	SL2691	C000460792	SL60	C000289247	SL60	WR50X26	SL60
116139	SL50	5304413855	SL45	C000460793	SL60	C000289249	SL60	WR50X27	SL60
187C144H01	SL70	5304413856	SL70	C008871201	SL2690	C000289317	SL60	WR50X28	SL55
218876901	SL2690	5304415914	SL45	C008871202	SL2690	C000289318	SL60	WR50X30	SL55
218916201	SL2690	5304415915	SL55	C008871203	SL2690	C000289319	SL6792	WR50X31	SL55
2564D44H05	SL6792	5304415916	SL50	C3686602	SL60	C000293907	SL70	WR50X32	SL55
2655D44H04	SL6792	5304415917	SL60	C8731901	SL60	C000293911	SL70	WR50X34	SL50
2656D44H02	SL60	5304415918	SL70	C8736601	SL90	C000294635	SL70	WR50X35	SL55
2656D44H03	SL60	5316269001	SL2690	C8871201	SL55	C000298318	SL60	WR50X36	SL60
2656D44H04	SL60	5604-14-1	SL45	C8972003	SL10010	C000460792	SL60	WR50X37	SL55
2656D44H05	SL60	5604-14-2	SL60	E000707807	SFPC	C00048623	SL60	WR50X4	SL50
2656D44H09	SL50	5604-14-37	SL60	E000707809	SFPC	C00048727	SL60	WR50X45	SL45
3001363	SL2690	5604-14-4	SL45	E000707810	SFPC	C00048729	SL60	WR50X5	SL60
3007540	SL2690	5604-14-5	SL45	E000707811	SFPC	W2656D44H02	SL6792	WR50X50	SL50
3015075	SL2690	5604-14-6	SL60	F000112205	SL2690	W2656D44H03	SL6792	WR50X5001	SL50
3015195	SL2691	5604-14-7	SL60	F112205	SL2690	W2656D44H05	SL6792	WR50X5003	SL45
3015865	SL55	5604-14-8	SL60	F128154	SL2690	WC460792	SL6792	WR50X5007	SL45
3016814	SL2690	5604-15-1	SL45	F87333	SL50	General Electric		WR50X5009	SL60
3202296	SL50	5604-17-1	SL45	F88366	SL60	OEM No.	Supco No.	WR50X5013	SL60
3204985	SL2690	5604-17-2	SL60	G158067	SL2690	WR23X5030	SL60	WR50X5014	SL45
3206322	SL6322	5604-18-2	SL60	G158068	SL2690	WR49X211	SL50	WR50X5015	SL55
5300286103	SL70	5604-18-4	SL45	G158749	SL2690	WR49X430	SL5430	WR50X5016	SL45
5300460792	SL6792	5604-18-5	SL45	G158750	SL2690	WR50X10	SL60	WR50X5018	SL45

Defrost Thermostats Cross Reference

General Electric (Cont)		Gemline (Cont)		Maytag (Cont)		Maytag (Cont)		Therm-O-Disc (Cont)	
OEM No.	Supco No.	OEM No.	Supco No.	OEM No.	Supco No.	OEM No.	Supco No.	OEM No.	Supco No.
WR50X5019	SL60	GL60	SL60	12017804	SL50	B5638001	SL60	37T2143206	SL90
WR50X5020	SL45	GL6792	SL6792	12017806	SL50	B5645401	SL90	37T2143266	SL55
WR50X5021	SL50	GL70	SL70	12017816	SL50	B56454-1	SL90	37T3129134	SLT55
WR50X5022	SL55	GL80	SL80	12017823	SL50	B5666201	SL50	37T3129312	SLT55
WR50X5023	SL45	GL8366	SL8366	26230-2	SL55	B5681001	SL60	37T312967	SLT55
WR50X5024	SL45	GL8509	SL8509	26230-3	SL55	B56810-1	SL60	37TV31611462	SL2641
WR50X5025	SL60	GL8510	SL8510	26230-9	SL45	B5688901	SL90	Whirlpool	
WR50X5026	SL60	GL8513	SL8513	26289-1	SL60	B56889-1	SL90	OEM No.	Supco No.
WR50X5027	SL60	GL8515	SL8515	27268-1	SL60	B5752501	SL90	1100435	SL3084
WR50X5028	SL50	GL8517	SL8517	27791-1	SL60	B57525-1	SL90	1100436	SL3084
WR50X5029	SL45	GL8519	SL8519	27791-2	SL60	B5860-1	SL60	1103841	SL2697
WR50X5030	SL45	GL8528	SL8528	27791-4	SL60	C3686601	SL60	1103842	SL2697
WR50X5031	SL45	GL90	SL90	27791-5	SL70	C3686604	SL60	1106890	SL2697
WR50X5032	SL50	GLT45	SLT45	27791-6	SL60	C36866601	SL60	1108164	SL3084
WR50X5033	SL5022	GLT50	SLT50	27791-7	SL60	C36866602	SL60	1108165	SL3084
WR50X5034	SL55	GLT55	SLT55	27791-8	SL70	C36866604	SL60	1108182	SL2697
WR50X5041	SL50	GLT60	SLT60	520825-13	SL45	C8731902	SL70	1108199	SL3084
WR50X55	SL55	GLT70	SLT70	52085-1	SL55	C8731903	SL90	1108574	SL3084
WR50X6	SL45	GLT80	SLT80	52085-10	SL45	C8736601	SL90	1108575	SL3084
WR50X60	SL60	Klixon		52085-11	SL55	C8736602	SL55	1110545	SL3084
WR50X65	SL60	OEM No.	Supco No.	52085-12	SL60	C8736603	SL55	1110546	SL3084
WR50X66	SL50	20640IL60	SL5844	52085-13	SL45	C8765001	SL50134	1110762	SL3084
WR50X68	SL50	20640L44510-842	SLT55	52085-15	SL55	C8765002	SLT55	1110763	SL3084
WR50X7	SL60	20640L44510-860	SLT55	52085-17	SL80	C8770402	SL45	1113044	SL3084
WR50X70	SL50	20641L1137-596	SL5022	52085-19	SL8519	C8871201	SL55	1113405	SL3084
WR50X73	SL55	2NT01L0959	SLT55	52085-2	SL55	C8898601	SLT55	1115192	SL7500
WR50X74	SL55	Mars		52085-20	SL60	C8898603	SLT55	1115193	SL7500
WR50X75	SL55	OEM No.	Supco No.	52085-22	SL8528	C8972002	SL10010	1115456	SL3084
WR50X76	SL60	33008	SL45	52085-24	SL8528	C8972006	SL10010	1115457	SL3084
WR50X77	SL60	33009	SL50	52085-25	SL8528	C8972009	SL50	1118688	SL3084
WR50X83	SL90	33010	SL55	52085-28	SL8528	C8978401	SLT55	1118690	SL3084
WR50X88	SL90	33011	SL60	52085-3	SL55	C8978402	SLT55	1118691	SL3084
WR50X89	SL60	33012	SL70	52085-33	SL8528	R0157343	SL60	1118824	SL3084
WR50X9	SL5022	33013	SL243	52085-4	SL60	R0161012	SLT55	1118825	SL7500
WR50X90	SL55	33014	SL245	52085-5	SL45	R0161018	SL5844	1118826	SL3084
WR50X91	SL60	33015	SL247	520856	SL60	R0161023	SL5844	1121294	SL7500
WR50X92	SL55	33020	SL80	52085-6	SL55	R0161036	SL5844	1121295	SL7500
WR50X93	SL60	33021	SL90	520857	SL60	R0161060	SL7985	1127661	SL3084
Gemline		33031	SL5844	52085-7	SL60	R0161087	SL50	1127753	SL3084
OEM No.	Supco No.	33035	SL5022	52085-9	SL45	R0161088	SL50	1127754	SL3084
GL243	SL243	Maytag		55024-3	SL243	Sub-Zero		1127771	SL3084
GL245	SL245	OEM No.	Supco No.	55024-5	SL245	OEM No.	Supco No.	1127805	SL7500
GL247	SL247	0054156	SL90	55024-7	SL247	627180	SL5844	1127867	SL7500
GL249	SL249	0054160	SLT55	625844	SL5844	627985	SL7985	1127868	SL7500
GL2690	SL2690	0055501	SL10010	627051	SL5844	Therm-O-Disc		2000528	SL3084
GL2697	SL2697	0311729	SL5844	627180	SL5844	OEM No.	Supco No.	2149641	SL7503
GL3084	SL3084	0312471	SL10010	95092-1	SL7985	37T2129009	SL90	2149643	SL7503
GL45	SL45	10442402	SLT55	B5569-7	SL60	37T2129011	SL90	2149849	SL6155
GL50	SL50	10442407	SLT55	B5611401	SL60	37T2129022	SL60	2151215	SL3084
GL5022	SL5022	10442411	SLT55	B56114016	SL60	37T2129023	SL60	2154544	SL3084
GL55	SL55	10544001	SL50	B5630006	SL60	37T2129024	SL90	2161331	SL6155
GL5708	SL5708	10544003	SL50	B563006	SL60	37T2129025	SL70	2163894	SL7503
GL5709	SL5709	10544005	SL50	B5636401	SL50	37T2129026	SL60	2172694	SL7503
GL5844	SL5844	12017802	SL50	B5636404	SL50	37T2129049	SL90	2176066	SL6155

Defrost Thermostats Cross Reference

Whirlpool (Cont)		Whirlpool (Cont)		Whirlpool (Cont)		Whirlpool (Cont)	
OEM No.	Supco No.	OEM No.	Supco No.	OEM No.	Supco No.	OEM No.	Supco No.
2176941	SL7490	531668	SL2697	549701	SL2697	989319	SL2697
2182380	SL7503	531669	SL2697	549757	SL2697	989320	SL2697
2183072	SL7503	531676	SL2697	549758	SL2697	989553	SL2697
2183073	SL7490	531678	SL2697	549928	SL2697	989578	SL2697
2196155	SL6155	531679	SL2697	549929	SL2697	989579	SL2697
2221677	SL7503	531680	SL2697	625844	SL5844	989588	SL2697
4343917	SL7503	531688	SL70	627051	SL5844	989589	SL2697
4356928	SL8513	531689	SL2697	627180	SL5844	989624	SL2697
4387489	SL2697	531690	SL2697	627808	SL7985	989625	SL2697
4387490	SL7490	531769	SL70	627984	SL7985	989626	SL2697
4387498	SL6155	531813	SL2697	627985	SL7985	989685	SL2697
4387499	SL3084	531814	SL2697	628209	SL7985		
4387500	SL7500	531831	SL70	628397	SL7985		
4387501	SL8513	53435	SL70	831383	SL90		
4387503	SL7503	547048	SL2697	833958	SL2697		
480478	SL2697	547069	SL2697	850115	SL2697		
480594	SL2697	547088	SL2697	850116	SL2697		
480595	SL2697	547089	SL2697	850117	SL2697		
480851	SL2697	547090	SL2697	850118	SL2697		
481227	SL2697	547091	SL2697	850119	SL2697		
482290	SL2697	547295	SL2697	850120	SL2697		
482697	SL2697	547296	SL2697	850121	SL2697		
483006	SL2697	547323	SL2697	850122	SL2697		
483007	SL2697	547454	SL2697	850341	SL2697		
483084	SL3084	547455	SL2697	850342	SL2697		
513315	SL2697	547853	SL2697	850607	SL2697		
513548	SL2697	547854	SL2697	850669	SL2697		
513574	SL2697	547855	SL2697	851022	SL2697		
513989	SL2697	547856	SL2697	851368	SL2697		
513990	SL2697	547857	SL2697	851390	SL2697		
515246	SL2697	547858	SL2697	851397	SL2697		
515315	SL2697	547859	SL2697	851674	SL2697		
530215	SL2697	547860	SL2697	851675	SL2697		
530216	SL2697	547861	SL2697	851890	SL2697		
530217	SL2697	547862	SL2697	851891	SL2697		
530253	SL2697	548463	SL2697	867035	SL90		
530254	SL2697	548464	SL2697	934390	SL2697		
530317	SL2697	548712	SL2697	934391	SL2697		
530318	SL2697	548713	SL2697	934424	SL2697		
530327	SL2697	548886	SL2697	934425	SL2697		
530328	SL2697	548887	SL2697	934426	SL2697		
530435	SL2697	548888	SL2697	934427	SL2697		
530668	SL70	548889	SL2697	934468	SL2697		
530679	SL70	548890	SL2697	934469	SL2697		
5308011166	SL2690	548891	SL2697	936139	SL2697		
5308871201	SL2690	548892	SL2697	936140	SL2697		
5308871202	SL2690	548893	SL2697	937071	SL2697		
5308871203	SL2690	548894	SL2697	937072	SL2697		
530990	SL2697	548895	SL2697	937303	SL2697		
531068	SL2697	548896	SL2697	937304	SL2697		
531069	SL2697	549698	SL2697	942871	SL3084		
531479	SL2697	549699	SL2697	942872	SL3084		
531480	SL2697	549700	SL2697	9791823	SL7490		

Refrigeration Replacement Parts

GE - Shelf supports are symmetric - use on left or right side



SP7232

OEM Part No.	SUPCO Part No.	Color	Dimensions	Replaces	Pack
WR2X7232	SP7232	Off White	1 3/4" W X 2" H bar	GE WR2X7232, WR2X7232R	2
WR2X7233	SP7233	Off White	1" W X 2" H bar	GE WR2X7233, WR2X7233R	2
WR2X8345	SP8345	White	1 1/2" W for 2" H bar	GE WR2X8345, WR2X7617	2
WR2X9144	SP9144	White	3/4" W for 2" H bar	GE WR2X9144, WR2X8776	2

Whirlpool - Shelf supports are symmetric - use on left or right side



SP695



SP696

OEM Part No.	SUPCO Part No.	Color	Dimensions	Replaces	Pack
839904	SP695	White	For 1 3/8" bar	Whirlpool 655657, 655143, 655450, 943125, 982123, Inglis 01839904	2
839975	SP696	White	For 3/4" bar	Whirlpool 655658, 655451, 655177, 943127, 982122, 839975D, Inglis 01839975	2
912361	SP698	White	For 1 3/8" bar	Whirlpool / Inglis 912361	2
912583	SP699	Almond	For 1 3/8" bar	Whirlpool / Inglis 912583	2
4318297	SP697	White	For 3" bar	Whirlpool 1106861, 1124343, 2148026	2

Universal Cam Risers for GE, Whirlpool, & others.



DR001

OEM Part No.	SUPCO Part No.	Description	Color	Dimensions	Replaces	Pack
WR2X4901	DR001	Cam Riser	Black	3/4" X 1 1/4"	GE WR2X4901, WR2X7512, Whirlpool 4318165 replaces most door cams, black for colors.	2

Crisper Shelf for Newer Style General Electric - Roper - Sears

Designed as a direct replacement for WR32X10398 Crisper Cover. Replaces older style cover WR32X1094, WR32X1107, and WR32X1122. The Crisper Shelf is opaque white plastic, double wide (24 1/2" wide X 18 5/8" deep) shelf. The newer design is stronger than the older WR32X1094 style crisper shelf. Cover has molded in glides for two half-width pans or one full-width pan.

CS10398



OEM No.	Supco No.	Description	Color	Dimension	Replaces	Packaged
WR32X10398	CS10398	Crisper Shelf	Opaque - White	24 1/2" X 18 5/8"	WR32X1094 WR32X1107 WR32X1122	1 or 6

AC Hard Starts

A/C Hard Starts

Choosing the correct hard start for the application combines a technical need with a professional preference. Select from the broadest offering of hard starts from the Pioneer of Hard Start technology.

Three (3) styles to choose from:

- **SPP Series** PTC/Capacitor combination
- **SPPE Elite Series** Electronic Potential Relay (EPR)/Capacitor combination
- **SK3W Series** 3-wire Potential Relay/Capacitor combination

Applications

- Use on any single phase air conditioner or refrigeration unit
- Low voltage situations
- Hard starting compressors



SPP Series PTC/ Capacitor Combination

Features/Benefits

- Positive Temperature Coefficient Technology (PTC)
- Field proven reliability
- Easy 2-wire installation
- Most economic



PART NO.	OPERATING VOLTAGE (VAC)	RECOMMENDED RANGE (hp)	INCREASE IN TORQUE (%)
SPP*	90 – 277	½ to 10	250%
SPP5	90 – 277	½ to 10	300%
SPP6	90 – 277	½ to 10	500%
SPP7S	90 – 277	½ to 10	600%

* This model does not include a capacitor



SPPE 'E Class' Series EPR/Capacitor Combination

Features/Benefits

- Electronic Potential Relay Technology (EPR)
- Backup electronic timing circuit to protect the compressor
- Voltage sensing
- Instant re-start
- Easy 2-wire installation
- Can be used on PSC and CSIR type compressors



PART NO.	OPERATING VOLTAGE (VAC)	RECOMMENDED RANGE (hp)	CAPACITOR Size (uF)
SPP4E	90 – 130	1/8 – 1	88–106
SPP5E	90 – 277	1/3 – 2	43–52
SPP6E	90 – 277	1/2 – 3	88–106
SPP7E	90 – 277	1 – 4	130–156
SPP8E	90 – 277	1 and up	189–227
SPP9E	90 – 277	1 and up	233–280
SPP10E	90 – 277	3 and up	270–324 / 330V



SK3W Series 3-wire Potential Relay/Capacitor Combination

Features/Benefits

- OEM-Style 3-wire Installation
- Instant re-start
- Easy installation with "fast clamp-on" connection
- Models for standard and scroll compressors
- 330 VAC Start Capacity Voltage

PART NO.	H.P. RATINGS	COMPRESSOR	DROP-OUT VOLTAGE (VAC)	PICK-UP VOLTAGE (VAC)	MAXIMUM COIL VOLTAGE	START CAP (mF)
SK3W2	1 thru. 2 HP	Standard	60-135	204-233	500 VAC	88 - 108
SK3W3	2½ thru. 3 ½ HP	Standard	60-121	171-184	420 VAC	189 - 227
SK3W5	4 thru. 5 HP	Standard	60-121	171-184	420 VAC	243 - 292
SK3W4S	3 thru. 4 HP	Scroll	60-135	204-233	500 VAC	189 - 227
SK3W6S	4½ thru. 6 HP	Scroll	60-121	171-184	420 VAC	270 - 324

Hard Start Comparison	SPPE Series	SPP Series	SK3W Series
Start Sensing Technology	Voltage	N/A	Voltage
Uses Electronic Potential Relay (EPR)	Yes	No	Yes
Instant Re-Start	Yes	No	Yes
Senses Motor Start	Yes	No	Yes
Two wire, non-polarized	Yes	Yes	No
OEM Style, 3-wire	No	No	Yes
Replaces 3-wire capacitor kit	Yes	Yes	Yes
UL approved	Yes	Yes	Pending
PTCR Device	No	Yes	No
Backup Timing Safety Circuit	Yes	No	No
Potentially damaging to motor windings	No	No	No
Requires non-replaceable fuse protection	No	No	No

Application Note: 2-wire vs. 3-wire Installation

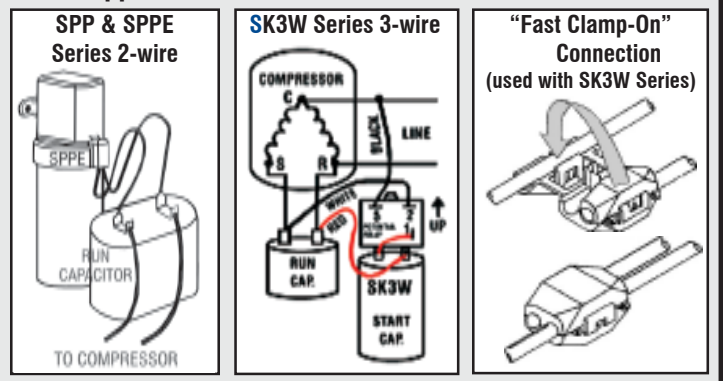

Relays

Universal Potential Relays

Note: See Technical Area for Application Note on Relays

Replacing all potential relays, these WIRE TO WIRE Universal Potential Relays offer the ultimate in convenience. One potential relay to fit any application. Choose to “drop in” the SUPR Universal Potential Relay or “dial in” the exact pick-up voltage for the APR5 Adjustable Potential Relay. State of the Art electronic circuitry provides Wire to Wire replacement of any potential relay with added motor protection.

Features/Benefits

- Reduces inventory
- Wire to Wire Replacement for virtually ALL potential relays.
- Recycles instantly
- Accomodates screw-on or push-on connections.
- Dimensions identical to industry standard potential relays.
- Easy replacement mounting with universal mounting bracket.
- Start winding protection if motor does not start.
- Prevents start capacitor venting when motor doesn't start.

Applications

- Replaces all OEM potential relays
- Used on any single phase motor or air conditioning and refrigeration compressor up to 5 hp.

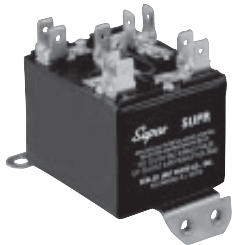

SUPR Universal Potential Relay

- Time Function Relay
- Start Time: 1.0 - 0.5 seconds

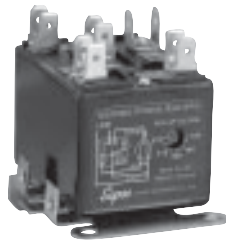

APR5 Adjustable Potential Relay

- Adjustable, Voltage Sensitive Relay
- Set pick-up voltage
- Safety time out 1.0 – 1.5 seconds



Common Specifications

Operating Voltage	110 – 270 VAC, Single Phase
Amperage	30 AMP
Motor Power Rating	up to 5 hp
Operating Position	Non-positional mounting.
Universal Mounting Bracket	Allows for easy installation. Unused portions of the bracket simply snap off with pliers.
Terminals	Screw or push-on. Adapters to convert screw-on to push-on are provided.
Dimensions	1.75W x 2.25L x 1.50H

90X Series Potential Relays

- Meets all requirements of OEM relays
- Universal break-off bracket

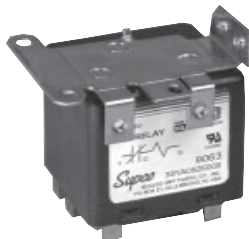

Features/Benefits

- 50/60 cycle
- Contact rating 35 amp @ 277 VAC
- Non-positional
- Instructions and wiring diagram included in each relay



PART NO.	CONTINUOUS COIL VOLTAGE	PICK-UP MIN.	PICK-UP MAX.	DROP MAX.	OUT REPLACES GE 3ARR3 RELAY GROUPS*
9063	170	139	153	55	2J; 2K; 2L; 2M; 5N; 7J; 7K; 7L; 7M; 7N; 8L; 8M; 8N
9064	395	260	275	120	3A; 3B; 3AV; 3AU; 4A; 4B; 6A; 6B; 6AV; 10A; 10B; 10AU; 10AV; 14A; 14B; 16A
9065	332	168	182	90	3P; 3R; 3AP; 5P; 5R; 5S; 5T; 13P; 19N; 22S
9066	395	215	225	120	3U; 3V; 3AT; 6U; 6V; 6W; 16U
9067	420	295	315	125	3C; 3D; 3AA; 4C; 4D; 4BK; 6C; 6D; 6AA; 10C; 10D; 26A; 26B; 26C; 26D
9068	502	325	345	135	3E; 3F; 3AB; 3AC; 4E; 4F; 4G; 6E; 6F; 6G; 10H; 10AB; 10AC; 26E; 26F; 26G; 26H; 27E; 27F; 27G
9069	336	180	195	105	3S; 3T; 10S; 10T; 10AS; 13S; 13T; 20S; 25S; 25T
9070	253	285	305	77	5B; 5C; 5D; 5AA; 8B; 8C; 8D; 27A; 27B; 27C
9071	420	212	232	121	6TV; 6TW; 10V; 16TV; 20V

903X Series General Purpose Switching Relays

Double pole – double throw (DPDT)

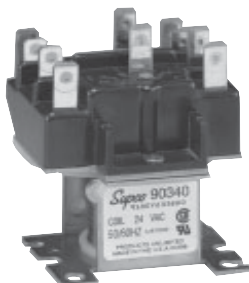

Applications

- HVAC/ R
- Appliance vending machines
- Fan controls
- Business machines



PART NO.	COIL VOLTAGE	TERMINAL 1-2-3	TERMINAL 4-5-6	CROSS REFERENCE	
				ESSEX/RBM	HONEYWELL
90340	24	power	power	90-340	R8222D1014
90341	110/12	power	power	90-341	R4222D1013
90342	208/240	power	power	90-342	R4222N1021

CONTACT RATINGS	POWER 208/240V		PILOT 208/240V	
	120V	277V	120V	277V
Full Load Amps	12	6	-	-
Resistive Amps*	15	15	3	3
Locked Rotor Amps	60	35	-	-
Horsepower	3/4	3/4	1/10	1/10

*0.75 power factor

Relays

902XX & 903XX Series General Purpose Fan Relays

Engineering Data

- **CONTACTS:** SPST-NO, SPST-NC, SPDT, 1 NO/1 NC, Material/ Power - Silver Alloy, Material 1/2 Pilot - Fine Silver
- **POWER RATINGS (All Forms):** 125 VAC, 18A Resistive, 12 FLA, 60 LRA, 240/277 VAC, 18A Resistive, 8 FLA, 48 LRA
- **SPECIAL POWER RATINGS (Form 1 & 2):** 125 VAC, 14 FLA, 84 LRA, 277 VAC, 25A Resistive
- **PILOT RATINGS (All Forms):** 3A, 277 VAC Gen. Purpose, 250 VA @ 250 VAC, 277 VA @ 277 VAC, 125 VA @ 125 VAC
- **COILS :** Voltage Ratings - 24, 120, 208/240, 77 VAC, 12, 24 VAC Frequency - 50/60 Hz Pick-up Voltage - AC 85% of nominal, DC 75% of nominal, Power Ratings -AC DC, Inrush 5 VA 3VA, Sealed 3 VA 3 VA

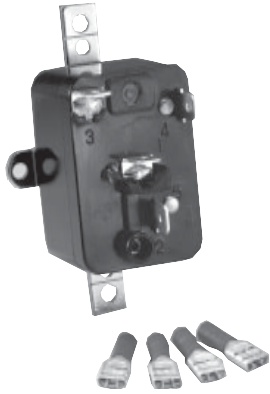

PART NO.	DESCRIPTION	AMPS	COIL VOLTAGE
90290	SPST	4	24V
90291	SPST	4	120V
90292	SPST	4	240V
90293	SPDT	1	24V
90294	SPDT	1	120V
90295	SPDT	1	240V
90370	SPDT	12	24V
90372	SPDT	12	120V
90374	SPDT	12	240V
90380	IN/NC	13	24V
90382	IN/NC	13	120V
90384	IN/NC	13	240V

Short Cycle Protector, Time Delay Relay and Contactor Combination

- Choose Delay on Break or Delay on Make model
- Ideal for split systems not supplied with contactor or time delay relay
- Prevents short cycling
- Contactor takes compressor load off the thermostat circuit

Features/Benefits

- Adjustable Delay
- Relay coil same voltage as load
- 1/4" male quick connect terminals
- Encapsulated circuitry
- Input Voltage: 208 - 230 VAC
- Maximum Amps: 30 A



PART NO.	DELAY TYPE	DELAY RANGE
TDP269	Delay on Make (DOM)	6 sec. to 300 sec.
TDC22	Delay on Break (DOB)	1 sec to 350 sec.

Compressor Protection Package Combination

Combines Hard Start Kit with maximum compressor protection.

Features/Benefits

- Can be installed in pilot circuits for 24 to 288 VAC
- Adjustable time delay from 6 seconds to 5 minutes
- Operates with or without cooling thermostat anticipator
- Only two terminal connection on Time Delay
- Can be mounted as an assembly or snapped apart for separate mounting
- Two models available to suit specific requirements

Applications

- Residential and commercial PSC A/C units and heat pumps
- For all PSC A/C units from 1 H.P. to 10 H.P.
- Can be used on 115 thru 288 VAC units
- For severe low voltage or hard starting compressors



PART NO.	INCREASED TORQUE	TIME DELAY RANGE
SPP5TD	270 ounce inches (300%)	6 sec. to 5 minutes
SPP6TD	390 ounce inches (500%)	6 sec. to 5 minutes

Capacitors



Motor Run Capacitors

Features:

- Non – PCB biodegradable synthetic oil
- Physical interrupter for safety
- Operating temperature –13°F to + 185°F (- 25°C to + 85°C)
- Microfarad μF tolerance +/- 5 %
- Drawn steel case construction
- Quad blade quick connect terminals
- Hermetically sealed

Applications:

- Air Conditioning Compressors
- Refrigeration Compressors
- Furnace Blower Motors

RUN CAPACITORS

PART NUMBER	VALUE (μF)	370 VAC	440 VAC	SINGLE	DUAL	OVAL	ROUND	PART NUMBER	VALUE (μF)	370 VAC	440 VAC	SINGLE	DUAL	OVAL	ROUND	PART NUMBER	VALUE (μF)	370 VAC	440 VAC	SINGLE	DUAL	OVAL	ROUND
CR2X370	2	X		X		X		CR40X370R	40	X		X			X	CD35+7.5X440	35+7.5	X		X	X		
CR3X370	3	X		X		X		CR45X370R	45	X		X			X	CD40+5X440	40+5	X		X	X		
CR4X370	4	X		X		X		CR50X370R	50	X		X			X	CD40+7.5X440	40+7.5	X		X	X		
CR5X370	5	X		X		X		CR55X370R	55	X		X			X	CD45+5X440	45+5	X		X	X		
CR6X370	6	X		X		X		CR60X370R	60	X		X			X	CD45+7.5X440	45+7.5	X		X	X		
CR7.5X370	7.5	X		X		X		CR70X370R	70	X		X			X	CD55+10X440	55+10	X		X	X		
CR10X370	10	X		X		X		CR80X370R	80	X		X			X	CR10X440R	10	X	X				X
CR12.5X370	12.5	X		X		X		CD20+5X370R	20+5	X			X		X	CR15X440R	15	X	X				X
CR15X370	15	X		X		X		CD20+7.5X370R	20+7.5	X			X		X	CR20X440R	20	X	X				X
CR17.5X370	17.5	X		X		X		CD25+3X370R	25+3	X			X		X	CR25X440R	25	X	X				X
CR20X370	20	X		X		X		CD25+4X370R	25+4	X			X		X	CR30X440R	30	X	X				X
CR25X370	25	X		X		X		CD25+5X370R	25+5	X			X		X	CR35X440R	35	X	X				X
CR30X370	30	X		X		X		CD30+3X370R	30+3	X			X		X	CR40X440R	40	X	X				X
CR35X370	35	X		X		X		CD30+5X370R	30+5	X			X		X	CR45X440R	45	X	X				X
CR40X370	40	X		X		X		CD35+5X370R	35+5	X			X		X	CR50X440R	50	X	X				X
CR45X370	45	X		X		X		CD40+5X370R	40+5	X			X		X	CR55X440R	55	X	X				X
CR50X370	50	X		X		X		CD45+5X370R	45+5	X			X		X	CR60X440R	60	X	X				X
CR60X370	60	X		X		X		CD80+5X370R	80+5	X			X		X	CR70X440R	70	X	X				X
CR70X370	70	X		X		X		CR2X440	2		X	X		X		CR80X440R	80	X	X				X
CD15+5X370	15+5	X			X	X		CR3X440	3		X	X		X		CD20+5X440R	20+5	X		X			X
CD15+10X370	15+10	X			X	X		CR4X440	4		X	X		X		CD25+5X440R	25+5	X		X			X
CD20+5X370	20+5	X			X	X		CR5X440	5		X	X		X		CD25+7.5X440R	25+7.5	X		X			X
CD20+15X370	20+15	X			X	X		CR6X440	6		X	X		X		CD30+5X440R	30+5	X		X			X
CD25+3X370	25+3	X			X	X		CR7.5X440	7.5		X	X		X		CD30+7.5X440R	30+7.5	X		X			X
CD25+5X370	25+5	X			X	X		CR10X440	10		X	X		X		CD35+5X440R	35+5	X		X			X
CD25+10X370	25+10	X			X	X		CR12.5X440	12.5		X	X		X		CD35+7.5X440R	35+7.5	X		X			X
CD30+3X370	30+3	X			X	X		CR15X440	15		X	X		X		CD35+10X440R	35+10	X		X			X
CD30+5X370	30+5	X			X	X		CR17.5X440	17.5		X	X		X		CD40+5X440R	40+5	X		X			X
CD30+7.5X370	30+7.5	X			X	X		CR20X440	20		X	X		X		CD40+7.5X440R	40+7.5	X		X			X
CD35+5X370	35+5	X			X	X		CR25X440	25		X	X		X		CD40+10X440R	40+10	X		X			X
CD35+7.5X370	35+7.5	X			X	X		CR30X440	30		X	X		X		CD45+5X440R	45+5	X		X			X
CD40+5X370	40+5	X			X	X		CR35X440	35		X	X		X		CD45+7.5X440R	45+7.5	X		X			X
CD45+5X370	45+5	X			X	X		CR40X440	40		X	X		X		CD50+5X440R	50+5	X		X			X
CD55+7.5X370	55+7.5	X			X	X		CR45X440	45		X	X		X		CD50+7.5X440R	50+7.5	X		X			X
CD60+10X370	60+10	X			X	X		CR50X440	50		X	X		X		CD55+5X440R	55+5	X		X			X
CR15X370R	15	X		X			X	CR55X440	55		X	X		X		CD55+7.5X440R	55+7.5	X		X			X
CR20X370R	20	X		X			X	CR60X440	60		X	X		X		CD55+10X440R	55+10	X		X			X
CR25X370R	25	X		X			X	CD25+5X440	25+5		X		X	X		CD60+5X440R	60+5	X		X			X
CR30X370R	30	X		X			X	CD30+5X440	30+5		X		X	X		CD60+7.5X440R	60+7.5	X		X			X
CR35X370R	35	X		X			X	CD35+5X440	35+5		X		X	X									

+ Indicates Dual Capacitor; R suffix indicates Round Capacitor

Capacitors

Motor Start Capacitors



UL approved Start Capacitors available in 110 VAC, 165 VAC, 220 VAC and 330 VAC.



Features

- Dry, electrolytic, non-polarized type for intermittent duty in AC motors and compressors.
- Used where starting torques must be higher in relation to running torques.
- Moisture and oil resistant molded phenolic resin or plastic material.
- Standard dual blade terminals.
- Industry standard case sizes.

110 to 130 VAC

PART NO.	VALUE (μF)	CASE SIZE
CS21-25X110	21-25	1
CS25-30X110	25-30	1
CS30-36X110	30-36	1
CS36-43X110	36-43	1
CS43-56X110	43-56	1
CS56-72X110	56-72	1
CS64-77X110	64-77	1
CS72-88X110	72-88	1
CS88-108X110	88-108	1
CS108-130X110	108-130	1
CS124-156X110	124-156	1
CS145-175X110	145-175	1
CS161-193X110	161-193	1
CS189-227X110	189-227	1
CS200-240X110	200-240	2
CS216-259X110	216-259	2
CS233-292X110	233-292	4
CS270-324X110	270-324	4
CS300-360X110	300-360	4
CS324-388X110	324-388	4
CS340-408X110	340-408	4
CS378-440X110	378-440	4
CS400-480X110	400-480	5
CS460-552X110	460-552	5
CS540-648X110	540-648	5
CS590-708X110	590-708	5
CS708-850X110	708-850	7
CS829-995X110	829-995	8
CS1000-1200X110	1000-1200	8

165 VAC

PART NO.	VALUE (μF)	CASE SIZE
CS124-156X165	124-156	4
CS145-175X165	145-175	4
CS161-193X165	161-193	4
CS233-292X165	233-292	5
CS270-324X165	270-324	5

330 VAC

PART NO.	VALUE (μF)	CASE SIZE
CS21-25X330	21-25	1
CS25-30X330	25-30	1
CS30-36X330	30-36	4
CS36-43X330	36-43	4
CS43-56X330	43-56	4
CS53-70X330	53-70	5
CS56-72X330	56-72	5
CS72-88X330	72-88	5
CS88-108X330	88-108	7
CS108-130X330	108-130	8
CS124-156X330	124-156	8
CS130-156X330	130-156	8
CS145-175X330	145-175	8
CS161-193X330	161-193	8
CS189-227X330	189-227	8
CS216-259X330	216-259	8
CS270-324X330	270-324	8
CS324-388X330	324-388	8

208 to 250 VAC

PART NO.	VALUE (μF)	CASE SIZE
CS21-25X220	21-25	1
CS25-30X220	25-30	1
CS30-36X220	30-36	1
CS36-43X220	36-43	1
CS43-56X220	43-56	2
CS56-72X220	56-72	2
CS64-77X220	64-77	4
CS72-88X220	72-88	4
CS88-108X220	88-108	4
CS108-130X220	108-130	4
CS124-156X220	124-156	5
CS145-175X220	145-175	7
CS161-193X220	161-193	7
CS189-227X220	189-227	7
CS216-259X220	216-259	8
CS233-292X220	233-292	8
CS270-324X220	270-324	8

Case Dimensions

CASE SIZE	DIAMETER	HEIGHT
1	1-7/16"	2-3/4"
2	1-7/16"	3-3/8"
4	1-13/16"	3-3/8"
5	1-13/16"	4-3/8"
6	2-1/16"	3-3/8"
7	2-1/16"	4-3/8"
8	2-9/16"	4-3/8"

Wiring Diagrams for Run Capacitors

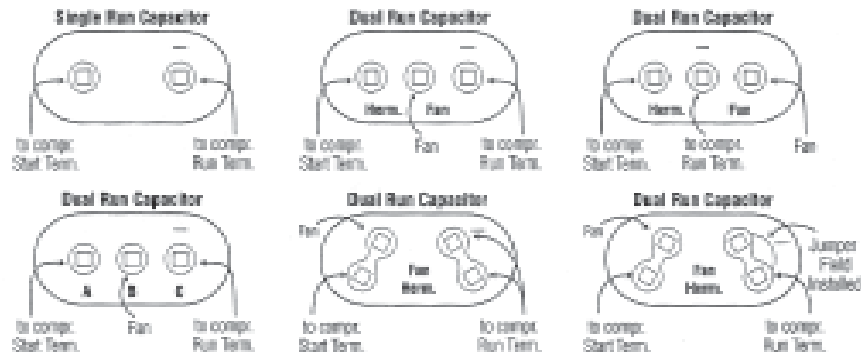

- A. Highest MFD
- B. Next highest MFD
- C. Always is common
- D. Lowest MFD if there are three capacitors

Line or Common terminal will always be installed in some way, either with a Red Mark by the terminal or sometimes a small dot or dash indented in the metal by the terminal.

When changing from any Dual Run Capacitor, with three(3) terminals, to a Dual Run Capacitor with four(4) terminals, the two Line or Common terminals should be jumpered.

Sequencers

THERMODISC®

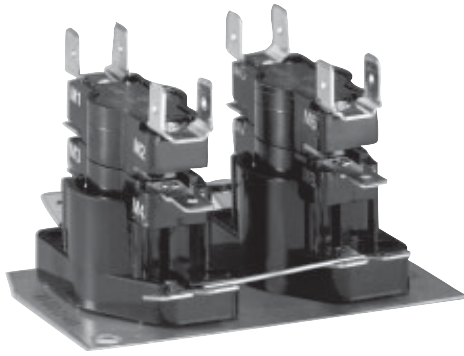

Features

- Direct replacement for most fan & heat sequencing functions.
- 24 volt input control
- Contacts designated M1 – M2 of a multi timing sequencer will turn on first and turn off last, as required by UL and CSA for electric heating applications.
- Five second on delay between all subsequent stages, unless they function together.

Applications

The SUPCO Q Series and Sequencers are field proven for controlling the operation of heating elements and or blower motors in electric, gas or oil heat systems.

- Electric furnaces
- Gas furnaces
- Heat Pumps
- Oil furnaces

Recommended Sequencer Packages for Electric Heating

Note 1: Auxiliary Contacts: In the above recommended packages, during the ON cycle, the auxiliary contacts complete the control circuit to subsequent 15S sequencers when more than one 15S sequencer is required. The auxiliary contacts may be any contacts in the first 15S sequencer except those marked M1-M2.

Note 2: Fan Interlock: The recommended combinations which contain more than one 15S sequencer include an extra set of contacts for fan interlock. (These are the first contacts of the second and third 15S sequencers.) A fan interlock is required by Underwriters Laboratories in order to guarantee that the fan will stay on until all elements are de-energized. All of the M1-M2 contacts of each 15S unit would be wired to the fan so that during the OFF cycle, the fan would stay energized regardless of the timing sequence of each package.

Note 3: Main Contacts, Electrical Ratings: 7FLA, 4LRA, 240 VAC inductive or 30A, 240 VAC resistive or 30A, 240 VAC total of inductive or resistive, with 7FLA, 240 VAC maximum inductive.

Note 4: Control Voltage on Heater Terminals (H): 24 VAC nominal (heater rated for 30 VAC/NEMA Class II circuit).

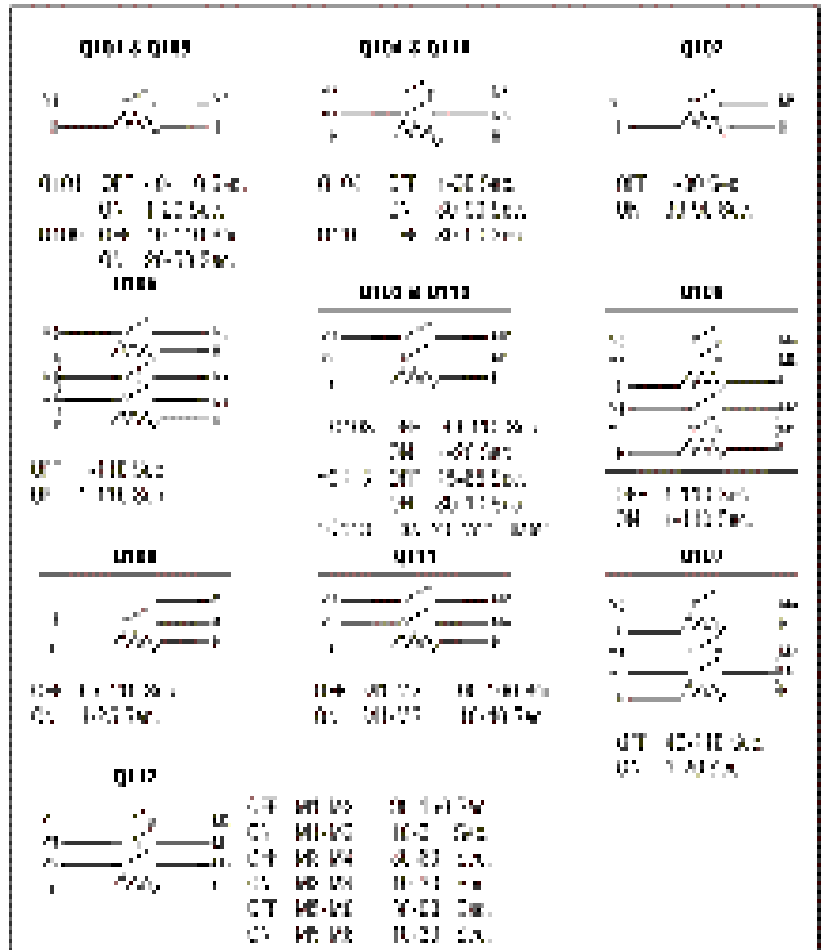

Cross Reference

SUPCO	MARS	WATSCO	KLIXON	TOD	W/R	JEPCO	OEM
Q101	33241	TDR10	6000AONI-98	15SH1309571	24A34-1	*	*
Q102	33342	TDR15	6000AONI-97	15SH1309572	24A34-2	*	*
Q103	33244	TDR20	6000AONI-87	15SH1309573	24A34-3	TD12	Janitrol BT 1256504
Q104	33245	TDR25	6000AONI-86	15SH1309574	24A34-4	TD34	*
Q105	33232	TDR30	51172-32	15SH1309575	24A34-5	51172-32-2	*
Q106	33233	*	51172-22	15SH1309576	24A34-6	*	*
Q107	*	*	*	15SH41	*	*	*
Q108	*	*	*	12S50M	*	*	Goodman B13707-38
Q109	*	*	*	15SH1	*	*	Janitrol BT 1256500
Q110	*	*	*	12S22	*	*	Weatherking 422311608
Q111	*	*	*	14S22	*	*	Weatherking 422311606
Q112	*	*	*	14SX22	*	*	Weatherking 422311607
Q113	33265	*	*	12S22	*	*	

*Note all sequencers include a 240 volt heater, except the Q113 which has a 240 volt heater.

Wall Thermostats



“Climate Technology Corporation”
A Hunter Fan Company

Thermostats...loaded with features, designed for value!

All CTC Thermostats Feature

User Friendly Programs and Features

- **Attractive Styling**
Blends well in any residential application.
- **Overheat Protection**
Prevents lock-up in the heat mode by not allowing heat to come on if temperature is over 95 degrees.
- **Static Protection**
Handles electrical spikes of up to 20,000 volts that could otherwise damage the system.

Mechanical

All models offer our “quiet switching” mercury bulb design and require no additional sub-base for heating, cooling or heating/cooling installation. All deliver maximum performance at a value price! All Mechanical Thermostats have a one year warranty.



43004 – Horizontal



43005 – Vertical

Heating/Cooling Thermostats

43004 – Horizontal 43005 – Vertical

- For use with most 4 or 5 wire 24 VAC systems and single-stage heat pumps
- Adjustable heat anticipator
- Terminations: RC, RH, W, Y, G, O, B

Cooling Only Thermostat

43320 – Vertical

- For use with most 2 wire 24 VAC systems
- Fixed cooling anticipator
- Terminations: RC, Y



43320 – Vertical

Heating Only Thermostats

43309 – Horizontal

- For use with most 2 wire 24 VAC and millivolt systems
- Adjustable heat anticipator
- Terminations: RH, W



43309 – Horizontal



43359 – Horizontal

Heating Only Thermostats

43359 – Horizontal

- 3-wire zone control
- Fixed heat anticipator
- Terminations: R, Y, W

Wall Thermostats

Digital

All CTC Digital and Programmable Thermostats

Feature:

- Latching relays for system compatibility
- Soft touch keypad
- Low battery indicator
- INDIGLO® Backlight
- Easy, front load battery access
- 2 AA batteries included
- F°/C° selector
- 3 year warranty

Are Compatible With:

- 24 VAC heat/cool, heat only or cool only systems
- Gas, electric or oil systems
- Millivolt systems
- 2 wire hydronic systems

(Not for use with 110/220V systems)

Have These Specifications:

- 20-30 VAC, 50/60 Hz
- Current draws 0.1 to 1.5 amps
- Temperature set range: 45° to 95°F (7° to 35°C)
- Operating differential +/- 1° F
- Compressor protection: 4 min. delay on break



43054
For Single-Stage Heat Pumps with INDIGLO® night-light

Additional Features:

- Electronic digital accuracy
- Large, easy-to-read LCD
- Filter change indicator
- No programming required
- No leveling required

Additional Specifications:

- 43054 Terminations: RC/O, RH/B, Y, W, G, R
- Bimetal freeze protection



43057
Heat Pump Thermostat Two-Stage Heat/Cool with INDIGLO® night-light

Additional Features:

- Refresh Programmable Fan
- AC Powered
- Filter change indicator
- No programming required
- 1st and 2nd Stage Span Adjustment

Additional Specifications:

- Display Temperature Limits 40° to 95° F
- Terminations: R.G. Y1, Y2, O, B, W2, L, E, C
- Compressor protection: 3.5 min. delay on break
- Bimetal freeze protection



43058

43058
For Multi-Stage Heat Pump/Conventional Two-Stage Heat/Cool Thermostat With Auto Season Changeover

Additional Features:

- Energy Monitor
- Filter Monitor
- No programming required
- "System On" indicators
- Keyboard lock
- Auto heat recovery
- AC powered with 2 AAA battery backup
- Optional hardwire remote sensors (43658)

Additional Specifications:

- Display temperature limits: 40° to 95°F
- Terminations: R, Y1, Y2, W1, W2, E, O, B, G, L, C
- Remote Sensor Terminations: RS1+, RS1-, RS2+, RS2-



43658

43658
Remote Sensor (Sold Separately)

Also Compatible With Most:

- Two-stage heat pumps with 2 heat/2 cool
- Two-stage heat pumps with 2 heat/1 cool
- Single-stage heat pumps
- Conventional two-stage heat/cool systems (Not for use with 110V/220V systems)
- Multi-stage heat/cool

Wall Thermostats

Programmable



43154
5 Day/2 Day Programming,
4 Periods Per Day
For Conventional Heat/Cool or
Single-Stage Heat Pump Systems

Also Compatible With Most:

- Single-stage heat pumps

Additional Features:

- Adjustable cycle rate
- Pre-programmed
- Easy "Front Load" battery access
- Mechanical low temperature protection
- Filter Monitor
- Up-opening door
- Two-stage low battery with fail safe protection

Additional Specifications:

- Terminations: G, RC, RH, Y/O, WB, Y1



43255
5 Day/1 Day/1 Day Programming, 4
Periods Per Day For Conventional Heat/
Cool or Single Stage Heat Pump Systems

Also Compatible With Most:

- Single-stage heat pumps

Additional Features:

- Adjustable cycle rate
- Pre-programmed
- Easy "Front Load" battery access
- Mechanical low temperature protection
- Filter monitor
- Up-opening door
- Two-stage low battery warning with fail safe protection

Additional Specifications:

- Terminations: G, RC, RH, Y/O, W/B, Y1



43355
7 Day Programming, 4 Programs
Per Day

Also Compatible With Most:

- Single-stage heat pumps

Additional Features:

- Adjustable cycle rate
- Pre-programmed
- Easy "Front Load" battery access
- Energy and filter use monitors
- Up-opening door
- Daylight Savings key
- Temporary and vacation overrides
- Programmable Hold
- Home Today Override
- Two-stage low battery warning with fail safe protection

Additional Specifications:

- Terminations: G, RC, RH, Y/O, W/B, Y1



43503
7 Day Programming, 4 Programs
Per Day With Auto Season Changeover

Additional Features:

- Auto Programming
- Keyboard lock
- Easy Front Load battery access
- Energy and filter use monitors
- Patented Home Today temporary override
- Vacation Hold override

Additional Specifications:

- Terminations: RC, RH, W, Y/Y1, G, O/B



43558
7 Day Programming, 4 Programs Per Day
For Multi-Stage Heat Pump/Conventional
Two-Stage Heat/Cool With Auto-Season
Changeover Thermostat

Also Compatible With Most:

- Two-stage heat pumps with 2 heat/2 cool
- Two-stage heat pumps with 2 heat/1 cool
- Single-stage heat pumps
- Conventional two-stage heat/cool systems (Not for use with 110V/220V systems)
- Multi-stage heat/cool

Additional Features:

- Energy Monitor
- "System On" indicators
- Keyboard lock
- Auto heat recovery
- Preprogrammed
- Filter Monitor
- Temporary/Vacation overrides
- Programmable Hold
- Home Today override
- Auto season changeover
- Optional hardwire remote sensors (43658)
- AC powered with 2 AAA battery backup

Additional Specifications:

- Terminations: R, Y1, Y2, W1, W2, E, O, B, G, L, C
- Remote Sensor Terminations: RS1+, RS1-, RS2+, RS2-



43658 Remote Sensor (Sold Separately)

Wall Thermostats

Mechanical

		Adjustable Heat Anticipator	Quiet Switching	Most Gas, Oil or Electric	24 VAC Nominal	Millivolt	Terminals	Product Dimensions
43320	Vertical Cool Only		●		●		RC, Y	
43309	Horizontal Heat Only	●	●	●	●	●	RH, W	
43359	Horizontal Heat Zone Control		●	●	●	●	R, Y, W	
43004	Horizontal Heat/Cool	●	●	●	●		RH, RC, G, Y, W, O, B	1.57"D X 4.5"W X 3.32"H
43005	Vertical Heat/Cool	●	●	●	●		RH, RC, G, Y, W, O, B	1.57"D X 4.5"W X 3.32"H

Digital

		Large LCD Digital Accuracy	Easy to Read Display	Filter Change Indicator	F°/C° Readout	Battery Powered	Low Battery Indicator	No Leveling Required	Heat/Cool & Heat Only Systems	Terminals	Remote Sensor Terminals	Product Dimensions
43054	Electronic w/ INDIGLO® Night-Light	●	●	●	●	●	●	●	●	RC/O, RH/B, Y, W, G, R		1.125"D X 4.75"W X 4"H
43058	Digital Multi-Stage Heat Pump/Conventional	●	●	●	●	Battery Backup	●	●	●	R, Y1, Y2, W1, W2, E, O, B, RS2-	RS1+ RS1- RS2+	1.5"D X 7"W X 4.75"H
43057	Heat Pump Thermostat 2-Stage Heat/2-Stage Cool. Single & Multi-Stage	●	●	●	●		●	●	●	R, G, Y1, Y2, O, B, W2, L, F, C		1.25"D X 5"W X 4.75"H

Programmable

		Program Flexibility	Programs Per Day	Preprogrammed	Auto Recovery	Filter Change Indicator	F°/C° Readout	Temporary & Vacation Overrides	Home Today Override	Energy Monitor	Battery Powered	Heat/Cool or Heat Only	Keyboard Lock	Single-Stage Heat Heat Pump	Terminals	Remote Sensor Terminals
43154	Programmable w/INDIGLO® Night-Light	5+2	4	●	●	●	●	●			●	●		●	RC, RH, Y/O, W/B, Y1, G	
43255	Programmable w/INDIGLO® Night-Light	5+1+1	4	●	●	●	●	●			●	●		●	RC, RH, Y/O, W/B, Y1, G	
43355	Programmable w/INDIGLO® Night-Light	7	4	●	●	●	●	●	●	●	●	●		●	RC, RH, Y/O, W/B, Y1, G	
43503	Programmable w/AutoSeason Changeover	7	4	●	●	●	●	●	●	●	●	●	●	●	W, RH, RC, G, Y/Y1, O/B	
43558	Programmable Multi-Stage Heat Pump/Conventional	7	4	●	●	●	●	●	●	●	Battery Backup	●	●	●	R, Y1, Y2, W1, W2, E, O, B, G, L, C	RS1+ RS1- RS2+ RS2-

Thermostat Guards

SUPCO offers a complete line of metal and plastic thermostat guards for the HVAC industry. Manufactured with the highest quality materials and production standards to ensure rugged dependability and attractive appearance.

Metal Thermostat Guards

- 18-22 Gauge Steel
- Baked Enamel Finish
- Louvered Cover
- Maximum Protection

Plastic Thermostat Guards

- Hi-Impact Plastic
- Clear
- Opaque
- Bronze

All Models

- Locking Key
- Mounting hardware
- Vertical or Horizontal Mounting



Designer Series
BTG-DK



Universal Series
BTG-U02

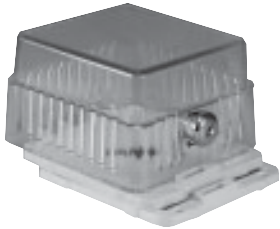

Elite Series
BTG-EK



Classic Series
BTG-O

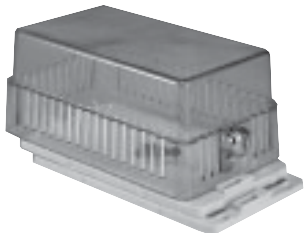

Regal Series
BTG-RK



Sentinal Series
BTG-54VL

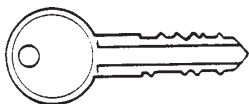

F336

SERIES	DESCRIPTION	INSIDE DIMENSIONS	INSIDE DIMENSIONS
		SOLID BASE (H x W x D)	RING BASE (H x W x D)
Designer			
BTG-DK	Clear Plastic	4 1/4" x 7 5/8" x 2 1/8"	4 1/8" x 7-1/16" x 2-1/4"
BTG-DB2	Bronze Plastic	4 1/4" x 7 5/8" x 2 1/8"	4 1/8" x 7-1/16" x 2-1/4"
BTG-DO	Opaque Plastic	4 1/4" x 7 5/8" x 2 1/8"	4 1/8" x 7-1/16" x 2-1/4"

Universal

BTG-UK2	Clear Plastic	8 1/4" x 5 3/8" x 3 1/2"	8 1/8" x 4 5/8" x 3-5/8"
BTG-UB2	Bronze Plastic	8 1/4" x 5 3/8" x 3 1/2"	8 1/8" x 4 5/8" x 3-5/8"
BTG-UO2	Opaque Plastic	8 1/4" x 5 3/8" x 3 1/2"	8 1/8" x 4 5/8" x 3-5/8"
BTG-UM	Metal	8 1/4" x 5 3/8" x 3 1/2"	*
BTG-UWM	Metal	*	6 3/4" x 4 1/4" x 3 9/16"

Elite

BTG-EK	Clear Plastic	3 7/8" x 3 1/2" x 2 1/2"	*
BTG-EO	Opaque Plastic	3 7/8" x 3 1/2" x 2 1/2"	*
BTG-EM	Metal	3 7/8" x 3 1/2" x 2 1/2"	*

Classic

BTG-K	Clear Plastic	5 1/4" x 4 3/8" x 3"	5 1/4" x 4 5/8" x 3 1/4"
BTG-O	Opaque Plastic	5 1/4" x 4 3/8" x 3"	5 1/4" x 4 5/8" x 3 1/4"
BTG-KM	Metal	5 1/4" x 4 3/8" x 3"	*
BTG-KWM	Metal	*	5 1/4" x 4 5/8" x 3 1/4"

Regal

BTG-RK	Clear Plastic	6 3/8" x 3 1/2" x 3"	6 3/8" x 3 1/2" x 3 1/4"
BTG-RB2	Bronze Plastic	6 3/8" x 3 1/2" x 3"	6 3/8" x 3 1/2" x 3 1/4"
BTG-RO	Opaque Plastic	6 3/8" x 3 1/2" x 3"	6 3/8" x 3 1/2" x 3 1/4"
BTG-RM	Metal	6 3/8" x 3 1/2" x 3"	*
BTG-RWM	Metal	*	6 3/8" x 3 1/2" x 3 1/4"

Sentinal





BTG-54VL	Metal Hinged	6 1/4" x 4 1/4" x 3 1/8"	*
BTG-54VLW	Metal Hinged	*	6" x 3 3/4" x 3 1/8"

F336	Replacement Key	Fits All Models
------	-----------------	-----------------



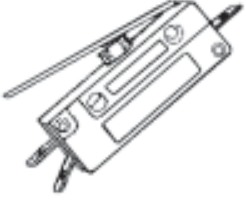

Dishwasher Parts

Exact Replacement Dishwasher Parts

Electrolux

<p>807007 DW602</p>	<p>807008 DW601</p>	<p>807043 ES16300</p>	<p>807680 ES16802</p>
			
<p>Roller Rack & Cap Kit Also: D&M 807007</p>	<p>Roller Rack Kit Also: D&M 807008</p>	<p>Door Switch Also D&M and Maytag</p>	<p>Float Switch Reference: 530807680</p>

Electrolux

<p>808180K DW114</p>	<p>809018 DW117</p>	<p>809703 DW118</p>	<p>3205549 DW116</p>
			
<p>Pop-Up Tower Kit Reference: 5303943007</p>	<p>Spray Arm Bolt Also D&M and Maytag</p>	<p>Door Spring Reference: 530809703</p>	<p>Tower Gasket Reference: 5303351197</p>

General Electric

<p>WD1X1147 DW145</p>	<p>WD1X1154 DW146</p>	<p>WD1X1308 DW150</p>	<p>WD1X5488 DW148</p>
			
<p>Door Spring</p>	<p>Door Spring</p>	<p>Door Spring</p>	<p>Check Valve</p>

Part numbers and illustrations are intended solely for identification. Items offered for sale are not represented to be manufactured by the company that built the original model.

Dishwasher Parts

Exact Replacement Dishwasher Parts

General Electric

WD3X749
DW154



Soap Cup Door Spring

WD6X130
ES16300

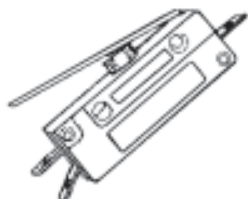

Door Switch

WD6X183
DW440



Door Switch

WD7X14
DW309



Door Cable

General Electric

WD8X181
DW155



Gate Arm Shaft Seal

WD8X227
DW156



Rightside Door Corner Gasket

WD8X228
DW157



Leftside Door Corner Gasket

WD12X235
DW143



Hub Bearing

General Electric

WD12X5028
DW144



Sump Cover

WD19X10032
DW105



Pump Rebuild Kit

Rebuild Kit for
WD26X10013

Replaces:
WD19X10032
WD19X62
For pump assemblies
that can be rebuilt.

WD22X110
DW151



Tower Gasket

Part numbers and illustrations are intended solely for identification. Items offered for sale are not represented to be manufactured by the company that built the original model.

Dishwasher Parts

Exact Replacement Dishwasher Parts

General Electric

WD22X114 DW111	WD22X120 DW112	WD22X124 DW152	WD22X71 DW113
			
Spray Arm Support	Fine Thread Power Shower	Coarse Thread Power shower	Spray Arm Support

General Electric

WD26X10013 DW10013

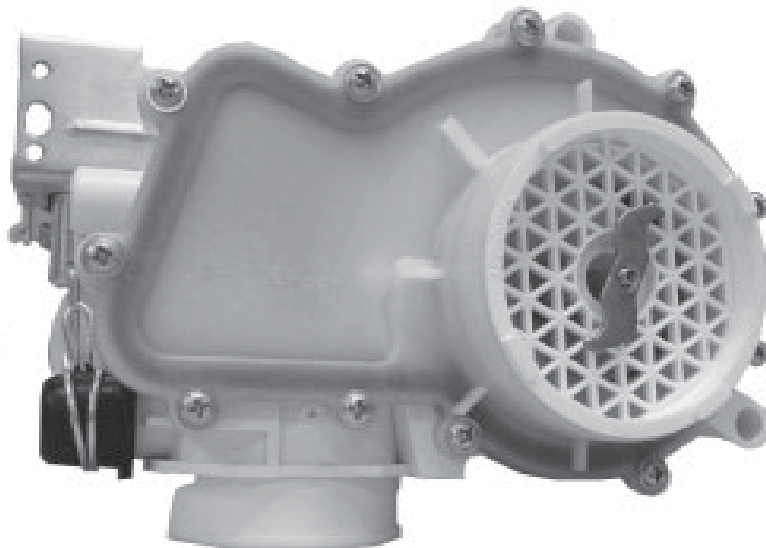

Dishwasher pump assembly used since 1970. Ready to install, solenoid and capacitor premounted. Necessary mounting hardware included with the pump assembly.

Replaces: WD26X10011,
WD26X10007
WD26X10003
WD26X77
& many more.

Need a pump rebuild kit?

WD19X10032 DW105



Replaces:
WD19X10032
WD19X62
For pump assemblies
that can be rebuilt.

Dishwasher Parts

Exact Replacement Dishwasher Parts

Whirlpool

300105
DW439

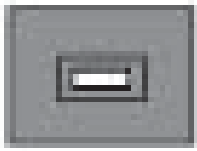

Soap Cup Shaft Seal

303919
ES16600

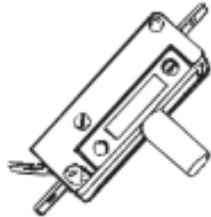

Interlock Switch

674744
DW307



Door Spring

675611
DW308



Door Spring

Whirlpool

716348
DW605



Upper Rack Roller

3367910
DW132



Spray Arm Nozzle Cap

4159914
ES16300

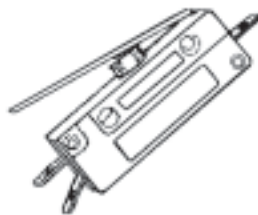

Door Switch

4160011
ES16100

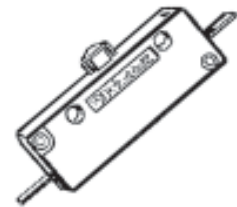

Door Switch

Whirlpool

4160496
DW303



Door Spring

4161629
DW304



Door Spring

4162322
DW610



Lower Rack Roller

4172010
DW606



4 Per Kit
Upper Rack Roller Kit

Dishwasher Parts

Universal Dishwasher Parts

<p>1161</p> 	<p>CUFA</p> 	<p>CUFE</p> 	<p>DWLC</p> 
<p>Faucet Snap Coupler Adapter</p>	<p>Straight Use with bulk hose 3/4", 1", 1 1/4" cutoffs Triple Connector</p>	<p>Right Angle Use with bulk hose 5/8", 3/4", 1 1/8" cutoffs Triple Connector</p>	<p>Use with bulk hose 3/4", 1", 1 1/4" cutoffs Triple Connector</p>
<p>DW804</p> 	<p>SD75125</p> 	<p>SSDW7</p> 	<p>SSDW100</p> 
<p>Connector GDK1 / GDK2</p>	<p>3/4", 1", 1 1/4" cutoffs Universal Connector</p>	<p>5/8" X 7 feet 5/8", 3/4", 1 1/8" cutoffs Universal Drain Hose</p>	<p>100 feet Bulk 5/8" PVC Hose</p>
<p>SSDWK</p> 	<p>UDA125</p> 	<p>Garbage Disposal Parts</p>	
<p>100 feet bulk hose 24 ea. DWLC connectors 1 can PVC Cement Universal Drain Hose Kit</p>	<p>Dishwasher to Disposal Universal Drain Adapter</p>	<p>LP670</p> 	<p>LP671</p> 
		<p>Splash Guard</p>	<p>Splash Guard</p>

Part numbers and illustrations are intended solely for identification. Items offered for sale are not represented to be manufactured by the company that built the original model.

Washer Parts

Exact Replacement Washer Parts

Alliance

20129
LP515



Boot Seal

23540
ES16200

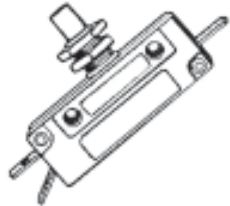

Door Safety Switch

27612
ES16807

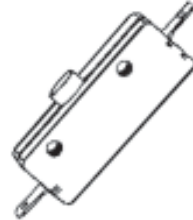

SPST Lid Switch

562P3
LP1586



Anti-Siphon Kit
Reference: 297P3 & 386P3

Alliance

34963P
GVW151

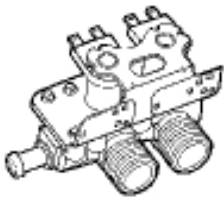

120V Water Valve
3/8" & 1/2" adapter

200937P
LP127



Direct Drive Pump
Reference: 36863P

Electrolux

131208500
GVW151

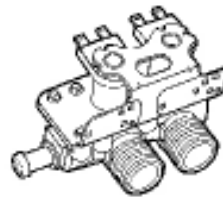

120V Water Valve
3/8" & 1/2" adapter
Reference: 5303207418
5308006679

131862900
DE788



Idler Pulley
Reference: 3204422

Electrolux

134049200
SSD8



Universal Drain Hose

5300184701
ES16200

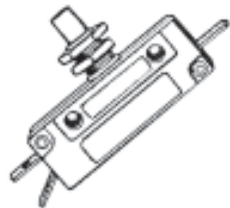

Door Safety Switch
Reference: 5303261027

5303912510
LP118



Franklin Style Pump
Reference: F133058

5303912530
LP394



Tub Grommet

Washer Parts

Exact Replacement Washer Parts

General Electric

WH1X1944
LP301



Drive Spline
Fine shaft (20 Teeth)

WH1X1986
LP701



Spline Coupling

WH1X2089
LP216



Lid Switch Actuator

WH1X2721
LP217



White Selector Knob
1 3/4" dia. 1/4" D shaft
Flat Left
Red Indicator

General Electric

WH1X2727
LA189



Tub Dampening Strap
Approx. 6" Long

WH1X2760
LP227

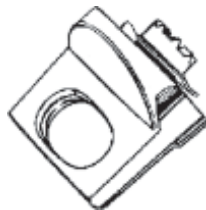

Chrome
Washer Knob

WH1X484
LP933



Foot Pad

WH2X10032
LP10032



New Style Tub Seal

General Electric

WH8X10018
LP510



Star Boot
Reference: WH8X246

WH8X281
LP604



Lower Shaft Seal
for Transmission

WH8X291
LP602



Agitator Shaft Seal
(Seal Only)

WH8X291K
LP603





Agitator Shaft Seal Kit
(2 Pcs.)

Part numbers and illustrations are intended solely for identification. Items offered for sale are not represented to be manufactured by the company that built the original model.

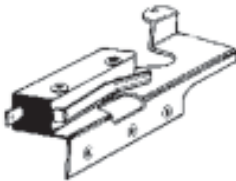
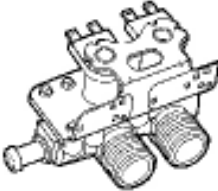

Washer Parts

Exact Replacement Washer Parts

General Electric

<p>WH8X305 LP656</p>	<p>WH12X494 LP211</p>	<p>WH13X81 GVW151</p>	<p>WH16X513 LA188</p>
 <p>Main Upper Tub Gasket Black Rubber</p>	 <p>Lid Switch Assembly</p>	 <p>120V Water Valve 3/8" & 1/2" adapter Reference: WH13X76</p>	 <p>Plastic Retainer Clip Used after 1995 to hold drain hose</p>

General Electric

<p>WH23X10013 LP129</p>	<p>WH23X42 LP112</p>	<p>WH41X35 GNBA</p>
 <p>Pump & Motor Assembly Reference: WH23X10003</p>	 <p>4 Hose Pump WH23X53 (conversion kit Included)</p>	 <p>Aluminum Drain Hose Nozzle for plastic order GNB</p>

General Electric

<p>WH41X367 SSD6GE</p>	<p>WH43X87 LP949</p>	<p>WH43X102 LP948</p>	<p>WX5X1325 TB123A</p>
 <p>No Kink Drain Hose 4 ft order SSD4GE 6 ft order SSD6GE 8 ft order SSD8GE</p>	 <p>Agitator Short 15 1/2" Tall</p>	 <p>Agitator Long 17" Tall</p>	 <p>Universal Washer Wrench for GE, Maytag, & Whpl.</p>

Part numbers and illustrations are intended solely for identification. Items offered for sale are not represented to be manufactured by the company that built the original model.



Washer Parts

Exact Replacement Washer Parts



Maytag

<p>015494 LP349</p>	<p>201112 LP920</p>	<p>201537 LP347</p>	<p>201809 ES16600</p>
			
<p>0A4298 LP348</p>			
 <p>Agitator Shaft Seal</p>	<p>Anti-Siphon Kit for kit with 4' extender order LP5834</p>	<p>Boot Seal Mounts between inner and outer tub</p>	<p>Older Models Long Stem Lid Switch</p>

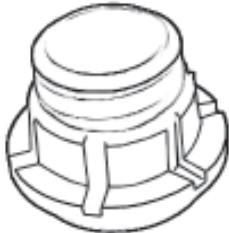
Maytag

<p>202203 LP117</p>	<p>22204012 LP340</p>	<p>204013 LP341</p>
		
<p>Washer Pump Newton Style</p>	<p>Mounting Stem Seal Kit Reference: 204012 & 2-4012 Order TB123A to install / remove.</p>	<p>Lower Tub Bearing Kit Reference: 2-4013</p>

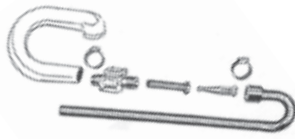
Maytag

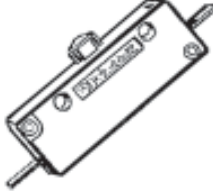
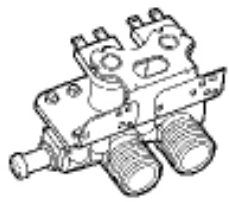

<p>204660 LP663</p>	<p>205000 LP921</p>	<p>204415 ES16100</p>	<p>205613 205614 33-2374N GVW151</p>
			
<p>Water Injector Kit for older style Newton models with rubber inlet hose</p>			<p>Glide & Spring Kit Reference: 2-5000</p>

Part numbers and illustrations are intended solely for identification. Items offered for sale are not represented to be manufactured by the company that built the original model.



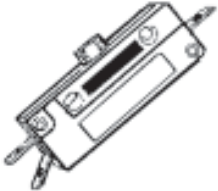

Washer Parts

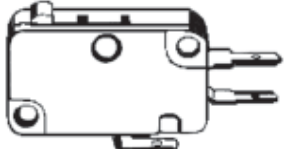
Exact Replacement Washer Parts



Maytag

<p>205416 ES16301</p>	<p>206154 LP585</p>	<p>206680 LP666</p>	<p>207166 ES7166</p>
			
<p>Lid Switch (3 terminal) 1950's to Current Reference: 33-3382</p>	<p>Injector Tube Older Style Newton Rubber Side Mount</p>	<p>Water Injector Kit for newer style Newton models with plastic inlet hose</p>	<p>Check Switch Used in 2201682</p>

Maytag

<p>211726 LP923</p>	<p>212989 LP956</p>	<p>213013 LP665</p>	<p>213015 LP580</p>
			
<p>Lid Hinge Ball Newton Models</p>	<p>Tub to Pump Hose Approx. 15" Long</p>	<p>Valve Hose Inlet to Injector</p>	<p>Injector Nozzle Used in both old & new</p>

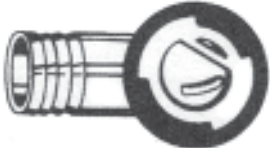
Maytag



<p>214765 LP992</p>	<p>215235 LP668</p>	<p>216016 LP991</p>	<p>216201 LP581</p>
			
<p>Siphon Break Gasket Used with 216016</p>	<p>Injector Tube Newer Style Newton Plastic Inlet</p>	<p>Siphon Break Elbow Gasket included</p>	<p>Injector Valve Used: 204660 & 206680</p>

Part numbers and illustrations are intended solely for identification. Items offered for sale are not represented to be manufactured by the company that built the original model.

Washer Parts

Exact Replacement Washer Parts

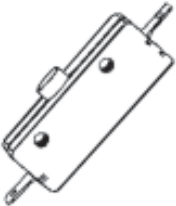

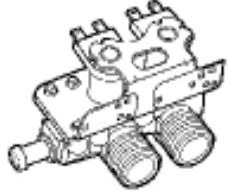

Maytag

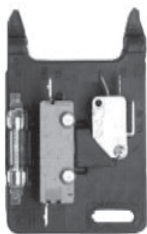
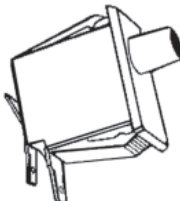
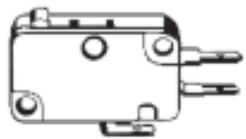
<p>12001187 ES16807</p>	<p>12001586 LP1586</p>	<p>12002533 LP2533 (Grey)</p>	<p>22001274 GVW151</p>
			
<p>Use with plastic or metal bracket Ref: 33-9064, 21001137</p>	<p>Antisiphon Kit Has sleeves for new style plastic drain hose</p>	<p>Door Boot w/drain Ref: 12001772, 22001978 Can be used to replace Black Boot 22003898</p>	<p>120V Water Valve 3/8" & 1/2" adapter</p>

Maytag

<p>22001682 ES682</p>	<p>22002044 ES16806</p>	<p>22002162 ES7166</p>
		
<p>New Style Lid Switch Assembly Complete with both switches and 4 amp fuse See 205415 & 207166 for individual switches</p>	<p>Tub Displacement (Out of Balance) Switch</p>	<p>Door Switch Lock / Spin Enable Front Loader</p>

Maytag

<p>22002263 10C7</p>	<p>21001873 LP128</p>	<p>21001906 LP123</p>	<p>27001233 LP127</p>
			
<p>Lamp (in latch) Used in Washer & Dryer</p>	<p>New Style Pump with metal plate Reference: 21002240</p>	<p>Late Model Pump Top Inlet Reference: 21001732</p>	<p>Direct Drive Pump Reference: 27001036 40040301</p>

Part numbers and illustrations are intended solely for identification. Items offered for sale are not represented to be manufactured by the company that built the original model.

Washer Parts

Exact Replacement Washer Parts

Whirlpool

21365
LP953



Cap Washer

21366
LP331

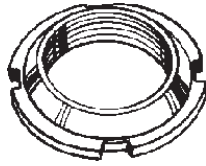

Drive Block Nut
Use with 96384
or 389140
Wrench order TB123A

76660
LP920



Anti-Siphon Kit
for Calypso Kit
order LP5834

76673
LP655



Tub Repair Kit
4 Bolts
4 Washers
4 Fiber Washers

Whirlpool

80040
LP338



Agitator Dog
Order 12 pack
80040D = LP338D
Reference
285770, 285770D

84867
89814

Control Magnet
Only order LP246



Control Magnet
w / Kit order LP247

85114
LP932



Foot Pad

91938
LP631



Center Post
Upper Seal
O.D. - 1 9/16"
I.D. - 1 3/16"
Thickness - 9/16"

Whirlpool

91939
LP632



Upper Shaft Seal
O.D. - 1"
I.D. - 3/4"
Thickness - 1/2"

93553
LP598



Outer Tub Grommet
"Button Trap"
2 3/4" I.D.

93770
LP617



Old Style Lid Bumper
All Rubber

95440
LP928



Drain Elbow
with Snap Lever

Part numbers and illustrations are intended solely for identification. Items offered for sale are not represented to be manufactured by the company that built the original model.



Washer Parts

Exact Replacement Washer Parts



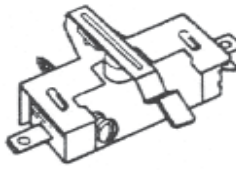

Whirlpool

<p>96384 LP332</p>	<p>99618 LP730</p>	<p>123931 TB123A</p>	<p>239453 ES16400</p>
			
<p>Drive Block Belt Drive Models 2 5/32" Tall Tub Nut Order LP331</p>	<p>Bearing & Seal Kit Used on Early Models 2 bearings, 2 lip seals, and 1 tube seal</p>	<p>Wrench Set to Remove Tub Nut Also for GE & Maytag</p>	<p>Motor Switch 5 terminal Replaces: 298800 Sears 80443</p>

Whirlpool

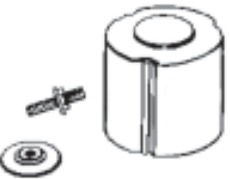
<p>279173 LP173</p>	<p>279347 LP210</p>	<p>285134 LP731</p>	<p>285206 LP988</p>
			
<p>Universal Push to Start Switch Kit</p>	<p>Lid Switch Kit Order LP985 (691581) for lever only Reference: 350484</p>	<p>Bearing & Seal Kit Later Belt Drive Models 2 bearings, 2 lip seals, and 4 tube seals</p>	<p>Direct Drive Washer Agitate Gear Cam</p>

Whirlpool



<p>285285 LP951</p>	<p>285317 LP115</p>	<p>285320 LP1586</p>	<p>285671 ES671</p>
			
<p>Agitator Cap Kit White with bolt</p>	<p>3 Hose Pump Belt Drive Models used on models that do have lint filter</p>	<p>Antisiphon Kit Plastic Drain Hoses or Rubber Drain Hoses includes inserts</p>	<p>Lid Switch Assembly Round Terminals 24" Wire 14" Tube</p>

Part numbers and illustrations are intended solely for identification. Items offered for sale are not represented to be manufactured by the company that built the original model.

Washer Parts

Exact Replacement Washer Parts

Whirlpool

<p>285672 LP925</p>	<p>285748 LP254</p>	<p>285753 LP337</p>	<p>285811 LP285</p>
			
<p>Spring & Seal Kit For Agitator shaft in gearcase assembly Reference: 92814</p>	<p>Agitator Cam Kit Includes: 4" Cam Thrust Spacer 4 dogs</p>	<p>Motor Coupler Replaces earlier versions Order LP337HD to replace Heavy Duty - Commercial 285852</p>	<p>Agitator Cam Kit Includes: Medium Cam Thrust Spacer, & 4 Dogs Repl: 285746 & 285751</p>

Whirlpool

<p>285834 LP5834</p>	<p>285852 LP337HD</p>	<p>350365 LP113</p>	<p>350367 LP114</p>
			
<p>Antisiphon Kit for Calypso Includes 4 " Extension Hose</p>	<p>Heavy Duty - Commercial Motor Coupler Replaces earlier versions Reinforced Rubber Isolator</p>	<p>2 Hose Pump Belt Drive Models used on models that do not have lint filter</p>	<p>4 Hose Pump Belt Drive Models used on models that do have lint filter</p>

Whirlpool





<p>350920 LP319</p>	<p>355519 LP218</p>	<p>356500 LP219</p>	<p>356934 LP630</p>
			
<p>T- Bearing Main Transmission Thrust Bearing</p>	<p>Chrome Timer Knob 1/4 - 20 Threads No Extension Replaces White 355643</p>	<p>Chrome Timer Knob 1/4 - 20 Threads Used 1974 to 1984</p>	<p>Transmission Stem Seal O.D. - 1 9/16" I.D. - 1 3/16" Thickness - 1"</p>

Part numbers and illustrations are intended solely for identification. Items offered for sale are not represented to be manufactured by the company that built the original model.

Washer Parts

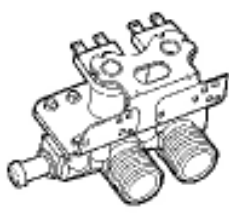
Exact Replacement Washer Parts

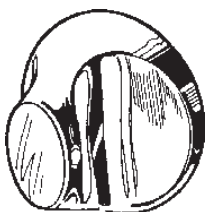



Whirlpool

<p>358276 GVW151</p>	<p>359449 LP634</p>	<p>359507 LP220</p>	<p>383727 LP633</p>
			
<p>120V Water Valve 3/8" & 1/2" adapter</p>	<p>Agitator Shaft Seal O.D. - 1 9/16" I.D. - 1 1/8" Thickness - 1/4"</p>	<p>Chrome 1/4 - 20 Threads 1/4" Extension</p>	<p>Outer Tub Main Seal (Tub Center Grommet) Reference:96690</p>

Whirlpool

<p>358336 LP318</p>	<p>389248 SM389248</p>	<p>482156 CS189-227X110</p>
		
<p>Snubber Pad Stabilizes tub during spin cycle</p>	<p>Speed Washer Motor 1/2 horsepower 1725 rpm on high 1140 rpm on low CS189-227X110 (482156) Capacitor separately</p>	<p>Start Capacitor Used on 2 & 3 Speed Direct Drive Washer Motors</p>

Whirlpool

<p>691581 LP985</p>	<p>3357027 GBNA</p>	<p>3348552 HP421</p>	<p>3349985 LP986</p>
			
<p>Switch Actuator Used with LP210</p>	<p>Aluminum Goosneck Plastic Gooseneck</p>	<p>Pump to Drain Connector Hose</p>	<p>Transmission Top Seal O.D. - 1 3/4" I.D. - 1 1/4"</p>

Part numbers and illustrations are intended solely for identification. Items offered for sale are not represented to be manufactured by the company that built the original model.

Washer Parts

Exact Replacement Washer Parts

Whirlpool

3352287
SM3352287



3 Speed Washer Motor
Order Capacitor Separately
CS189-227X110 (482156)

3355806
LP901



3 Coil Water Valve
Whirlpool / Sears
Typically Models with
Detergent Dispenser

3362624
LP225



2" Black Timer Knob
1 1/8" Metal Center
1/4 - 20 Threads
Replaces Almond Also

Whirlpool

3363394
LP116



2 Hose Pump
Direct Drive Models
Standard Outlet
no Check Valve

3363892
LP121



2 Hose Pump
Direct Drive Models
Oversize Outlet
has Check Valve

3364290
LP226



2 1/4" Black Timer Knob
1 3/4" Black Center
1/4 - 20 Threads

3364291
LP228



2 1/4" White Timer Knob
1 3/4" White Center
1/4 - 20 Threads

Whirlpool

3364293
LP234



2 1/4" Almond Knob
1 3/4" Almond Center
1/4 - 20 Threads

3949247
ES247



Lid Switch Assembly
3 Flat Terminals
27" Wire 14" Tube

4391969
SSD6



No Kink Drain Hose
4 ft. order SSD4
6 ft. order SSD6
8 ft. order SSD8

8318084
ES8084



Lid Switch Assembly
3 Flat Terminals
Harness plugs on to switch

Part numbers and illustrations are intended solely for identification. Items offered for sale are not represented to be manufactured by the company that built the original model.

Universal Hoses & Accessories

Universal Washer Drain Hoses

Features:

- Universal Design
- Economic
- Fits hundreds of models

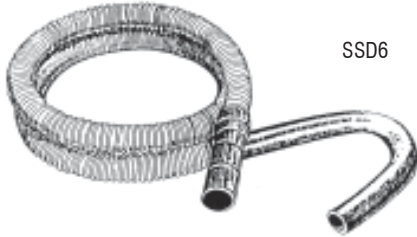

SSD6

Supco No.	Size	Connector Style	Step Down	Description
SSD4	1" X 4'	Straight	1", 1 1/8", & 1 1/4"	Universal
SSD4GE	1" X 4'	G.E.	1", 1 1/8", & 1 1/4"	GE Style, Order LA188 Clip
SSD6	1" X 6'	Straight	1", 1 1/8", & 1 1/4"	Universal
SSD6GE	1" X 6'	G.E.	1", 1 1/8", & 1 1/4"	GE Style, Order LA188 Clip
SSD8	1" X 8'	Straight	1", 1 1/8", & 1 1/4"	Universal
SSD8GE	1" X 8'	G.E.	1", 1 1/8", & 1 1/4"	GE Style, Order LA188 Clip



GNB

Build Your Own Drain Hose

- Step 1 Cut bulk hose to length
- Step 2 Use PVC cement to attach drain connector
- Step 3 Use PVC cement to attach gooseneck
- Step 4 Add antisiphon kit when needed



SSD50

Supco No.	Package	Description
SSD50	1" Dia.X 50 Feet	Bulk Washer Drain Hose
CUFA	1" X 1 1/8" X 1/ 1/4"	Universal Straight Connector
CUFE	1" X 1 1/8" X 1/ 1/4"	Universal 90° Connector
GNB	1" I.D.	Plastic Gooseneck
LP1586	Antisiphon Kit for Plastic Drain Hose	



CUFA

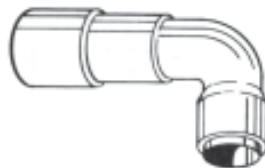

CUFE



LP1586

Hose Screens & Washers



LA094

Hose Washers

Supco No.	Package	Description
LA094	12	Green Stripe
LA100	100	Green Stripe



LA095

Hose Screens

Supco No.	Package	Description
LA095	25	30 Mesh Monel
LA091	100	30 Mesh Monel
LA096	25	60 Mesh Monel
LA092	100	60 Mesh Monel

Universal Hoses & Accessories

Accessories for Rubber Drain Hoses



GNBA



HL103



HM101

Supco No.	Description
GNBA	Aluminum 1" Dia. Gooseneck for rubber drain hose
HL103	90° elbow Hose Mender, for sharp bends - White
HM101	Straight Hose Mender - White
LP920	Standard Antisiphon kit for rubber hoses
LP1586	Antisiphon kit for rubber or plastic drain hoses
LP5834	Antisiphon kit with 4" extender, used on Calypso and Maytag

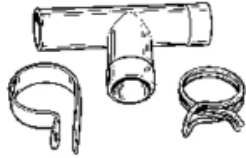

LP920



LP1586



LP5834



HYP38

"Y" Mixer Hose

HYP38 This high pressure mixing hose allows a washer to operate normally when only a cold water supply is available. Attach to water valve and fill hose.



3803FF

Washer & Dishwasher Inlet Hose

- Pressure tested to 800psi (cold) - 600psi (hot)
- Double crimped fittings for strength and safety
- Ozone resistant to prevent rubber decay
- Product Liability Insured



3803FE

Length	Female X Female	Female X 90° Female	Male X Female
3 Feet	3803 FF	3803 FE	3803 MF
4 Feet	3804 FF	3804 FE	3804 MF
5 Feet	3805 FF	3805 FE	3805 MF
6 Feet	3806 FF	3806 FE	3806 MF
8 Feet	3808 FF	3808 FE	
10 Feet	3810 FF	3810 FE	
12 Feet	3812 FF	3812 FE	



3803MF

New! PVC Inlet Hoses

- Built in washers
- Heat fused ends to prevent leaks
- Nylon couplers never rust or corrode
- 90° ends for tight spaces



3804FEPV

Supco No.	Length
3804FEPV	4 Feet
3805FEPV	5 Feet
3806FEPV	6 Feet

Exact Replacement Dryer Parts

Exact Replacement Dryer Parts Alliance Dryer Thermostats

OEM No.	Supco No.	Style	Temp. °F	Diff. °F	Term
51185	SET102	FL	325	50	2
51386	LD130	LD	130	15	3
51387	LD155	LD	155	20	3
51879	LD120	LD	120	15	3
51880	LD120	LD	120	15	3
51880A	LD145	LD	145	20	3
51897	SET110	L	120	10	2
52393	SET121	LD	145	20	3
52394	SET109	L	135	15	2
53708	SLF155VA	SLF	155	40	2
54736	LD120	LD	120	15	3
54737	SET153	LD	135	15	3
55742	SET133	F	300	50	2
56082	SET183	L	300	40	2
56115	SET110	L	110	10	2
56410	LD140	LD	140	20	3
56440	SET105	L	140	10	2
61372	FLD135	FLD	135	15	3
400011	L225	L	225	40	2
400198	L170	L	170	20	2
400199	L150	L	150	20	2
400209	L225	L	225	40	2
400296	L135	L	135	15	2



Style FL



Style FLD



Fuse



Style L

OEM No.	Supco No.	Style	Temp. °F	Diff. °F	Term
431177	L340	L	340	40	2
500807	LD120	LD	120	15	3
502498	L15510W	LW	155	10	4
503551	L15525W	LW	155	25	4
503552	L15510W	LW	155	10	4
503554	L15525W	LW	155	25	4
503979	LD135	LD	135	15	3
504237	FL225	FL	225	40	2
504514	L15510W	LW	155	10	4
504515	L15510W	LW	155	10	4
504516	L120	L	120	10	2
504517	L15525W	LW	155	25	4
504518	L155	L	155	20	2
504519	L14520W	LW	145	20	4
510701	FL225	FL	225	40	2
510702	SLF255VA	SLF	255	50	2
511412	SET182	Fuse	360	Fuse	2
M401254	SET105	L	140	10	2
M401255	SET129	L	165	2	2
M401256	L175	L	175	20	2
M401257	L200	L	200	40	2
M401258	L225	L	225	40	2
M4D9433	SET107	L	340	40	2



Style LD



Style LW



StyleSLF

Thermostat Kit 490P3 SET200



490P3 kit is used with 61927
For High Limit only see 510701 above
For Thermal fuse only see 511412 above
Reference: 511412 is also a 767511412

"M" Series Gas Valve 58804 25M0A-100



White
Rodgers



OEM No.	Supco No.	Orifice	Size
58804	25M01A-100	*#44	(.086)
60667	25M01A-100	#40	(.098)
62959	25M01A-100	#44	(.086)
504091	25M01A-100	*#42	(.0935)
60353P	25M01A-100	*#40	(.098)

*Use old orifice holder with new valve & orifice
Designed by White Rodgers to replace the "M" series clothes dryer valves. Kit shown is a right angle left outlet valve (RAL). Kit is a direct replacement valve with 8 orifices (6 Nat. & 2 LP), 2 bushings, and 2 nuts.

See 58804A & 58804B for replacement coils.

Dryer Parts

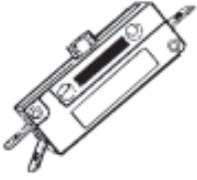
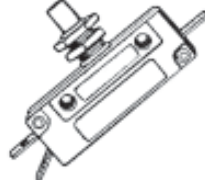



Alliance

<p>369P3 SDE359</p>	<p>33445 ES16301</p>	<p>51143 ES16200</p>	<p>51835 DE793</p>
			
<p>Round Igniter Spring Mount References: 54608, 56970, 58823, & 60868,</p>	<p>Coin Meter Switch Reference: 00-6103, 00-6163, 9128-1, M400001 T183-56</p>	<p>Dryer Door Switch Reference: 430540</p>	<p>Blower Wheel Shaft Smaller Blower Wheel</p>

Alliance









<p>52079 DE794</p>	<p>53001P DE795</p>	<p>53132 DE791</p>	<p>53519 DE910</p>
			
<p>Drum Shaft Bearing</p>	<p>Drum Roller Shaft Left Side</p>	<p>Drum Roller Shaft Right Side</p>	<p>Blower Wheel Shaft Larger Blower Wheel</p>

Alliance

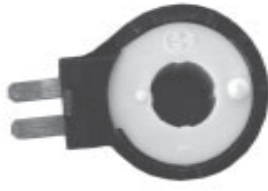
<p>54410 DE783</p>	<p>55428 SDE350</p>	<p>56225A DE381</p>	<p>56231 DE353</p>
			
<p>Idler Pulley Assembly Reference: 54415P</p>	<p>Round Ignitor Reference: M402743 Used 1981 and after</p>	<p>"K" Series Coil Kit Reference: 5303261027</p>	<p>I.R.Sensor Ref: M402742 & M402366</p>

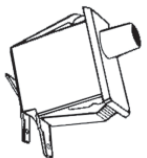
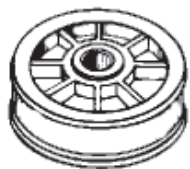
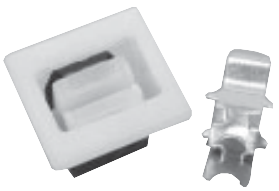
Part numbers and illustrations are intended solely for identification. Items offered for sale are not represented to be manufactured by the company that built the original model.

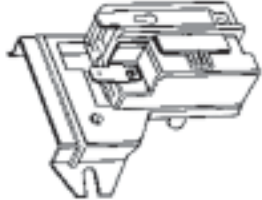
Dryer Parts

Alliance			
56461 DE796	58804A DE382AWR	58804B DE382BWR	60954 10C7
			
Drum Roller Shaft Used with 62649 Roller	Boost Coil 3 Terminals for "M" Series valve	Secondary Coil 2 Terminals for "M" Series valve	10 Watt Lamp
Alliance			
62649 DE691	504570 ES16806	510124 DE407	510177 DE902M
			
Drum Roller Used with 56461 Shaft	Switch Used on later models Reference: 56052, 62872, 430542, 504570 70107001, & M406119	Idler Pulley 54410 for pulley w/arm	Latch & Catch Kit Metal Latch Plastic Catch
Alliance			
510184P SDE364	510213 DE353	M400945 ES15807	M400947 DE947
			
Flat "M" Style Igniter Rapid Response Direct plug-in no bracket	I.R. Sensor Ref: M402742 & M402366	Permanent Press Toggle Switch	Cool Down Coin Meter Switch

Part numbers and illustrations are intended solely for identification. Items offered for sale are not represented to be manufactured by the company that built the original model.

Dryer Parts

Electrolux Dryer Thermostats

OEM No.	Supco No.	Style	Temp. °F	Diff. °F	Term		OEM No.	Supco No.	Style	Temp. °F	Diff. °F	Term
3204267	FL260	FL	250	50	2	 FL Style	5308001690	L150	L	150	20	2
3204307	L135	LDC	135	15	2		5308013213	L135	L	135	15	2
131298300	L14515W	Multi	140	15	4		5308013213	L135DC	LDC	135	15	2
134048800	L13515W	Multi	135	15	4		5308013595	SET104	FL	205	40	2
134120900	SLF222VA	SLF	222	40	2		5308015847	L145DC	LDC	155	20	2
131298400	L14515W	Multi	145	15	4		5308015856	FL200	FL	200	40	2
5300131743	SET119	LD	225	40	3		5308950121	SET104	FL	205	40	2
5300169845	LD120 & HA11	LD	120	10	3		5309951548	SET115	FL	240	50	2
5300169849	LD140 & HA11	LD	140	20	3		F30191	LD225	LD	225	40	3
5300169850	LD155 & HA11	LD	155	20	3		F32148	LD130	LD	130	15	3
5300169851	LD120 & HA11	LD	120	15	3	F36589	L205	L	205	40	2	
5300169853	LD135 & HA11	LD	135	15	3	F66908	L130	L	130	15	2	
5300169857	LD210 & HA11	LD	210	40	3	F76613	LD200	LD	200	40	3	
5300169858	LD240 & HA11	LD	240	40	3	F79198	L205	L	205	40	2	
5300169860	LD305 & HA11	LD	305	40	3	F132206	SET119	LD	225	40	3	
5300633905	L200	L	205	40	2	F65802-1	L150	L	150	20	2	
5300634209	L190	L	190	40	2	K1025647	L125	L	125	10	2	
5303211472	SLF330VA	SLF	330	50	2	K1027198	L225	L	225	40	2	
5303281034	L13515W	L	132	15	4	K1030890	L180-40	L	180	40	2	
5303281113	FL285	FL	285	40	2	K1031140	SET119	LD	225	40	3	
5303320997	SET105	L	140	10	2	K1034218	SET105	L	140	10	2	
5307531200	L13515W	L	135	15	4	K1035672	LD130	LD	130	15	3Style	
5307531201	L13510W	L	135	10	4	K1035674	L250	L	250	40	2	
5307531358	FL320	L	320	50	2	K1036048	L130	L	130	15	2	



Style LD



Style LDC



Style SLF



Multi-Temp



HA11 Adapter

Electrolux

"M" Series Gas Valve 25M0A-100

White Rodgers Direct Replacement Gas Valve Kit

Designed by White Rodgers to replace the "M" series clothes dryer valves. Kit shown is a right angle left outlet valve (RAL). Kit is a direct replacement valve with 8 orifices (6 Natural Gas & 2 LP), 2 bushings, and 2 nuts. Valve is a direct replacement, correct orifice included. Used since 1984.

White
Rodgers



25M01A-100

This genuine White Rodgers valve kit is designed to replace all right angle left outlet 25M series valves.

OEM No.	Supco No.	Orifice	Size
58804	25M01A-100	*#44	(.086)
60667	25M01A-100	#40	(.098)
62959	25M01A-100	#44	(.086)
504091	25M01A-100	*#42	(.0935)
60353P	25M01A-100	*#40	(.098)



Need a replacement coil kit for the "M" series valve?

Both Coils in a kit

For Electrolux 5303931775 order the direct replacement coil DE382WR

Booster / Holding Coil (3 terminal)

For Electrolux Q622601 order the direct replacement coil DE382AWR

Secondary Coil

For Electrolux Q622602 order the direct replacement coil DE382BWR











Part numbers and illustrations are intended solely for identification. Items offered for sale are not represented to be manufactured by the company that built the original model.

Dryer Parts

Electrolux			
3937010 DE339	131825900 DE727	134394900 SDE358	5300137504 DE520
			
Dryer Restring Kit Reference: 131475300	Bearing Reference: 5303281008	Igniter Reference: 134192000	Lint Screen
Electrolux			
530017854 DE381	5300234600 DE338	5300622032 DE335	5300622034 DE336
			
Coil Kit for "K" Series	Dryer Restring Kit	Dryer Restring Kit Reference: Q622032	Dryer Restring Kit Reference: Q622034
Electrolux			
5301167945 DE414	5303161103 DE413	5303281044 ES16806	5303281049 DE766
			
Drum Support Roller Kit Set of 5	Idler Pulley Assembly	Door switch	Felt Seal

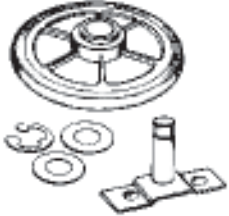
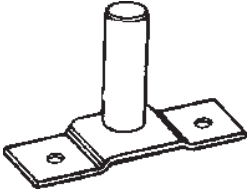
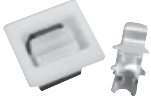
Part numbers and illustrations are intended solely for identification. Items offered for sale are not represented to be manufactured by the company that built the original model.

Dryer Parts

Electrolux			
5303281135 DE353	5303281153 DE724	5303931775 DE382WR	5303937139 DE790
			
Infrared Flame Sensor	Tub Bearing Kit	2 Coil Kit for "M" Series	Drum Felt with Glides Reference: 131154800 3201208, 5303211431
Electrolux			
5303937186 SDE364	5304440277 SDE350	5308057415 DE695	5308057416 DE694
			
Universal Flat Igniter "M" style with connector, wire nut kit included.	Round Igniter Reference: 5300600831 5301126982	Side Drum Roller Reference: F141888	Center Drum Roller Reference: F141724
Electrolux			
5308057417 DE699	5366021400 DE902M	5379499000 DE784	F133850 DE787
			
Roller Shaft for Center Drum Roller	Metal & Plastic DE902	Idler Pulley Assembly	Idler Pulley Reference: F133850-000
			
	Plastic Latch & Catch Kit		

Part numbers and illustrations are intended solely for identification. Items offered for sale are not represented to be manufactured by the company that built the original model.

Dryer Parts

General Electric

Dryer Thermostats

OEM No.	Supco No.	Style	Temp.°F	Diff.°F	Term		OEM No.	Supco No.	Style	Temp. °F	Diff.°F	Term
WE4M80	L290	L	290	40	2		WE4X587	SET188	L	140	15	2
WE4M127	SET187	L	135	15	2		WE4X589	L145	L	145	20	2
WE4M136	FL240	FL	240	50	2	Style FL	WE4X590	L135	L	135	15	2
WE4M137	SET800	LSP	310	80	2		WE4X591	L140	L	140	20	2
WE4M156	L125	L	125	10	2		WE4X592	SET192	L	300	40	2
WE4M160	SET104	FL	210	40	2		WE4X593	L300	L	300	40	2
WE4M216	L13510W	Multi	135	10	4	Fuse	WE4X594	L140	L	140	20	2
WE4X133	SET163	L	155	20	2		WE4X595	L155	L	155	20	2
WE4X151	L225	L	225	40	2		WE4X596	L130	L	130	15	2
WE4X254	SHF140	SHF	140	40	2		WE4X597	LD130	LD	130	15	3
WE4X255	L130	L	130	15	2	Style L	WE4X599	LD130	LD	130	15	3
WE4X256	L175	L	175	40	2		WE4X600	L145	L	145	20	2
WE4X257	L225	L	225	40	2		WE4X601	L135	L	135	15	2
WE4X258	SLF170VA	SLF	170	40	2		WE4X607	L145	L	145	20	2
WE4X261	L180-40	L	180	40	2	Style LD	WE4X608	L135	L	135	15	2
WE4X275	SET164	L	260	40	2		WE4X639	L205	L	205	40	2
WE4X291	SET189	L	155	25	2		WE4X670	L130	L	130	15	2
WE4X292	SET117	LD	155	20	3		WE4X690	L120	L	120	10	2
WE4X293	L270	L	270	40	2	Style SLF	WE4X691	SET187	L	135	15	2
WE4X295	LD145	LD	145	20	3		WE4X711	FL200	FL	200	40	2
WE4X323	LD170	LD	170	20	3		WE4X715	L145DC	LDC	145	20	2
WE4X324	SET192	L	300	40	2		WE4X755	L135	L	135	15	2
WE4X325	SET101	SLF	170	25	2	Style LDC	WE4X757	FL260	FL	260	50	2
WE4X325	SLF170VA	SLF	170	40	2		WE4X774	SLF222VA	SLF	222	40	2
WE4X339	SET129	L	165	20	2		WE4X800	SET800	LSP	310	80	2
WE4X340	L325	L	325	40	2		WE4X811	SET187	L	135	15	2
WE4X394	L325	L	325	40	2	Style LSP	WE4X812	SET193	L	325	50	2
WE4X395	SET188	L	140	15	2		WE4X813	SET190	L	230	40	2
WE4X396	SET153	LD	135	15	3		WE4X818	L130	L	130	15	2
WE4X419	SET189	L	155	25	2		WE4X819	L125	L	125	10	2
WE4X422	L165	L	165	20	2	Style Multi	WE4X820	SET193	L	325	50	2
WE4X429	LD140	LD	140	20	3		WE4X824	L145	L	145	20	2
WE4X454	L145	L	145	20	2		WE4X856	SET189	L	155	25	2
WE4X485	L145	L	145	20	2		WE4X857	SET401	Fuse	196	2
WE4X497	SET192	L	300	40	2	Style SHF	WE4X5040	L225	L	225	40	2
WE4X498	SET189	L	155	25	2		WE4X5091	SET105	L	140	10	2
WE4X510	L340	L	340	40	2		WE4X5098	L130	L	130	15	2
WE4X543	SET191	L	250	40	2		WE4X5099	FL260	FL	260	50	2
WE4X544	L130	L	130	15	2		WE4X5135	SET121	LD	145	20	3
WE4X545	L340	L	340	40	2		WE4X5136	LD155	LD	155	20	3
WE4X546	SET188	L	140	15	2	Style Multi	WE4X5137	SET144	FL	250	50	2
WE4X547	L130	L	130	15	2		WE4X5176	FL260	FL	260	50	2
WE4X549	L145	L	145	20	2		WE04X10002	FL260	FL	260	50	2
WE4X550	L135	L	135	15	2		WE04X10018	L14515W	Multi	145	15	4
WE4X551	L140	L	140	20	2	Style SHF	WE04X10028	L14515W	Multi	145	15	4
WE4X552	SET192	L	300	40	2		WE04X10055	L180-20	L	180	20	2
WE4X582	LD145	LD	145	20	3		WE04X10099	L13515W	Multi	135	15	4
WE4X583	SET189	L	155	25	2		WE25X139	L155	L	155	20	2
WE4X584	SET191	L	250	40	2	Style SHF	WE25X161	SET137	L	130	15	2
WE4X586	SET187	L	135	15	2		WE25X167	SET163	L	155	20	2

Part numbers and illustrations are intended solely for identification. Items offered for sale are not represented to be manufactured by the company that built the original model.

Dryer Parts

General Electric

"M" Series Gas Valves

25M0A-100 & 25MA-101

White Rodgers Direct Replacement Gas Valve Kit

**White
Rodgers**

Designed by White Rodgers to replace the "M" series clothes dryer valves. Each kit is a direct replacement valve with 8 orifices (6 Natural Gas & 2 LP), 2 bushings, and 2 nuts.



**25M01A-101 Right
Angle Left Outlet**

OEM No.	Supco No.
WE4X708	25M01A-101
WE4X709	25M01A-101
WE11X10009	25M01A-100
WE14X171	25M01A-101
WE14X207	25M01A-101
WE14X214	25M01A-101
WE14X215	25M01A-101
WE14X229	25M01A-101
WE14X10012	25M01A-100
WE14X10046	25M01A-101

Note: Match orifice to original or use old orifice. Special applications may require use of old orifice holder.



**25M01A-101
Right Angle Right Outlet**

Need a replacement coil kit for the "M" series valve?

Both Coils in a Kit	
OEM No.	Supco No.
WE04X10004	DE382WR
WE04X10020	DE382WR
WE04X10031	DE382WR
WE04X10048	DE382WR

**White
Rodgers**

Booster / Holding Coil (3 terminals)	
WE4X692	DE382AWR

Secondary Coil (2 terminals)	
WE4X693	DE382BWR

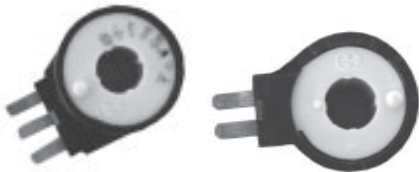

DE382WR





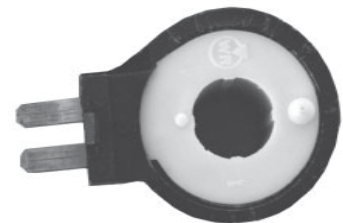





DE382AWR

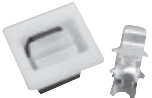

DE382BWR

Genuine White Rodgers Coil kits are designed to replace coils on the 25M series valves.

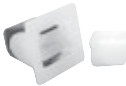
Dryer Parts

General Electric			
WE1M463 DE771	WE1M481 DE775	WE1X759D DE400	WE1X1201 DE773
			
Door Handle White Plastic Door Handle 4 3/8" X 1 1/2"	Teflon Front Glide 2 3/4" X 5/8"	Bushing inserts for WE12X81	Door Handle Almond Plastic Door Handle 7 1/4" X 1 1/2"
General Electric			
WE01X10023 DE902M	WE01X10122 DE905	WE01X10152 DE410	WE01X10156 LP217
			
Metal & Plastic DE902		Idler Arm assembly Reference: WE01X10030 WE01X10032, WE01X10052	
			
Plastic Latch & Catch Kit	Metal Panel Clip		Selector Switch Knob Reference: WE01X10033
General Electric			
WE3X37 DE726R	WE3X70 DE727	WE3X75 DE726	WE3X79 DE686
			
Straight Style Bearing for WE25X205	Tub Bushing for WE13X10011 & WE25X10001 Reference: WE03X10002	Right Side Top Hat Style Bearing for WE25X205	Drum Roller Shaft Used with WE3X82 Drum Roller

Part numbers and illustrations are intended solely for identification. Items offered for sale are not represented to be manufactured by the company that built the original model.

Dryer Parts

General Electric

WE3X82
DE702



Drum Roller Kit
For Washer / Dryer Combo

WE3X86
DE685



Left Side
Drum Roller Shaft
Used with
WE3X82 Drum Roller

WE3X87
DE776



Teflon Front Glide
2 3/4" X 1/2"

WE03X10001
DE790



Top Felt with
Glides

General Electric

WE03X1008
KIT

For Left Side Order
WE3X82 & WE3X86



For Right Side Order
WE3X82 & WE3X79

WE4M126
ES16806

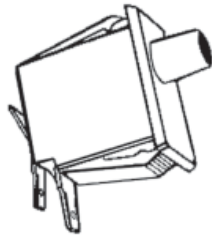

Door Switch

WE4X197
ES16700

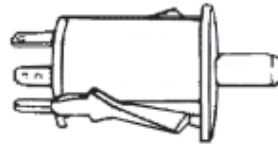

Door Switch

WE4X444
SDE350



Round Igniter
or Glow Bar

General Electric

WE4X448
DE355

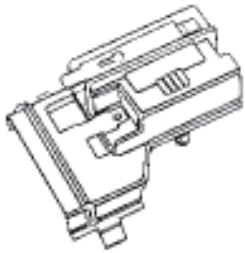

Infrared
Flame Sensor

WE4X532
ES15253



Belt Safety
Switch

WE4X739
SDE358



Shock Mount
Round Igniter

WE4X750
SDE364







"M" Style Flat Igniter
Reference: WE4X843

Part numbers and illustrations are intended solely for identification. Items offered for sale are not represented to be manufactured by the company that built the original model.

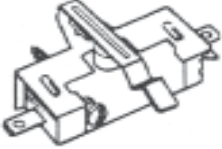
Dryer Parts

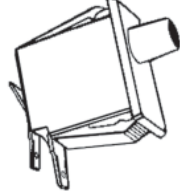



General Electric

WE4X814 LP210	WE04X10021 DE353	WE04X10046 ES16806	WE04X10132 SDE358
			
Door Switch Assembly For WE4X815 order Lever only LP985	Infrared Flame Sensor	Door Switch Reference: WE04X10034	Round Igniter Reference: WE04X10128 WE04X10116

General Electric

WE11M21C DE334	WE11X203 DE333	WE11X260 DE315D	WE11X261 DE316D
			
Restring Kit 5000 Watt 240 Volts 1/4" Q.C. Terminals	Restring Kit 5300 Watt 240 Volts 1/4" Q.C. Terminals	2 Coil Restring Kit 5000 Watt 230 Volts 1/4-28 Stud	2 Coil Restring Kit 5000 Watt 250 Volts 1/4-28 Stud

General Electric

WE11X60 DE315	WE11X61 DE316	WE11X90 DE337	WE11X99 DE338
			
1 Coil Restring Kit 2500 Watt 230 Volts 1/4-28 Stud	1 Coil Restring Kit 2500 Watt 250 Volts 1/4-28 Stud	Restring Kit 5000 Watt 230 Volts 1/4" Q.C. Terminals	Restring Kit 4500 Watt 240 Volts 5/16" Q.C. Terminals



Part numbers and illustrations are intended solely for identification. Items offered for sale are not represented to be manufactured by the company that built the original model.

Dryer Parts

General Electric

<p>WE11X10004 DE838</p>	<p>WE12X81 DE401</p>	<p>WE12X83 DE412</p>	<p>WE12X95 DE411</p>
			
<p>Dryer Element 5400 Watts 240 Volts</p>	<p>Idler Pulley Reference: WE12X47 WE12X33</p>	<p>Idler Pulley Reference: WE12X80 WE12X92 & WE12M8</p>	<p>Reference: WE12X10009</p>

General Electric

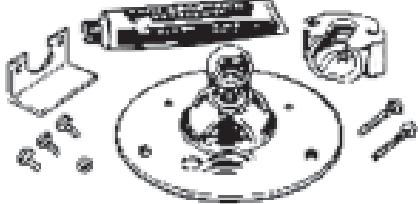
<p>WE13X68K DE729</p>	<p>WE13X93 DE730</p>	<p>WE13X10011 DE724</p>	
			
<p>Glide Kit to rebuild WE25X60 (2 needed)</p>	<p>Heavy Duty Bracket & Glide Assembly (2 Needed)</p>	<p>Drum Bearing Kit Reference: WE25X10001</p>	

General Electric



<p>WE18X26 DE520</p>	<p>WE25X60 DE731</p>	<p>WE25X62K DE725K</p>	<p>WE25X205 DE725</p>
			
<p>Lint Screen White Plastic Frame</p>	<p>Bracket & Glide Kit 2 brackets included</p>	<p>Rebuild Kit for WE25X205 & WE25X60</p>	<p>Drum Shaft and Bearing Kit</p>

Part numbers and illustrations are intended solely for identification. Items offered for sale are not represented to be manufactured by the company that built the original model.

Dryer Parts

Maytag

Dryer Thermostats

OEM No.	Supco No.	Style	Temp. °F	Diff. °F	Term		OEM No.	Supco No.	Style	Temp. °F	Diff. °F	Term
489P3	L255	L	255	40	2		62641	FL225	FL	225	40	2
492P3	L255	L	255	40	2		63589	L205	L	205	40	2
50850	L200	L	200	40	2		300608	SET111	L	150	20	2
50851	L225	L	225	40	2		300858	SET103	FLD	205	40	3
50880	SET109	L	135	15	2	300859	SET109	L	135	15	2	
51036	L150	L	150	20	2	301007	SET163	L	155	20	2	
51185	SET102	FL	325	50	2	301451	SET175	FL	220	40	2	
51186	FL200	FL	200	40	2	301552	SET106	L	145	10	2	
51386	LD130	LD	130	15	3	301634	SET121	LD	145	20	3	
51387	LD155	LD	155	20	3	301636	SET108	SHF	130	15	2	
51879	LD120	LD	120	15	3	301724	L180-40	L	180	40	2	
51880	LD120	LD	120	15	3	301933	FL150	FL	150	40	2	
51897	SET110	L	120	10	2	301948	L200	L	200	40	2	
51986	LD120	LD	120	15	3	301952	SET109	L	135	15	2	
51987	LD120	LD	120	15	3	301978	SHF160	SHF	160	20	2	
52393	SET121	LD	145	20	3	301979	LD170	LD	170	20	3	
52394	SET109	L	135	15	2	302838	SET109	L	135	15	2	
53752	L125	L	125	10	2	302850	SET145	FL	150	40	2	
54736	LD120	LD	120	15	3	303030	LD130	LD	130	15	3	
54737	LD135	LD	135	15	3	303035	SET163	L	155	20	2	
55099	L130	L	130	15	2	303036	SET145	FL	150	40	2	
55523	FL320	FL	320	50	2	303037	SHF130	SHF	130	15	2	
55741	SET195	L	120	10	2	303225	LD135	LD	135	15	3	
55742	SET133	F	300	50	2	303391	SET163	L	155	20	2	
56081	SET195	L	120	10	2	303392	SET105	L	140	10	2	
56082	SET133	FL	300	50	2	303394	SET108	SHF	130	15	2	
56115	SET195	L	120	10	2	303395	SET175	FL	220	40	2	
56116	LD140	LD	140	20	3	303396	SET104	FL	205	40	2	
56221	L255	L	255	40	2	303618	SET121	LD	145	20	3	
56410	LD140	LD	140	20	3	303773	SET105	L	140	10	2	
56440	SET105	L	140	10	2	303797	SET117	LD	155	20	3	
56470	L150	L	150	20	2	304474	SET117	LD	155	20	3	
56471	L120	L	120	10	2	304475	SET105	L	140	10	2	
56856	L155	L	155	20	2	305169	SET174	FL	240	40	2	
57015	L155	L	155	20	2	305864	SET106	L	145	10	2	
57239	LD120	LD	120	15	3	305865	SET145	FL	150	40	2	
58366	L255	L	255	40	2	305953	LD130	LD	130	15	3	
60191	L225	L	225	40	2	306060	SET111	L	150	20	2	
61210	FL225	FL	225	40	2	306608	SET111	L	150	20	2	
61372	FLD135	FLD	135	15	3	306910	L15515W	LW	155	15	4	
61401	L130	L	130	15	2	306911	L15515W	LW	155	15	4	
61556	L225	L	225	40	2	306965	SET175	FL	220	40	2	
61625	L15515W	LW	155	15	4	306966	FL200	FL	200	40	2	
61886	SLF255VA	SLF	250	50	2	306967	L15515W	LW	155	15	4	
62148	SET109	L	135	15	2	307249	L15515W	LW	155	15	4	
62600	FL350	FL	320	50	2	307250	LD15525W	LDW	155	25	5	



Style SLF

Part numbers and illustrations are intended solely for identification. Items offered for sale are not represented to be manufactured by the company that built the original model.

Dryer Parts

Maytag

Dryer Thermostats

OEM No.	Supco No.	Style	Temp. °F	Diff. °F	Term		OEM No.	Supco No.	Style	Temp. °F	Diff. °F	Term
308036	LD14520W	LDW	145	20	5	 Style FLD	60-7421	SET110	L	120	10	2
329314	LD135	LD	135	15	3		60-7424	SET103	FLD	205	40	3
400011	L225	L	225	40	2		60-7506	SET140	SLS	200	40	2
400198	L180-40	L	180	40	2		60-7879	L150	L	150	20	2
400199	SET111	L	150	20	2		60-7880	L250	L	250	40	4
400209	L225	L	225	40	2	60-9204	SET109	L	135	15	2	
400296	SET109	L	135	15	2	60-9210	SET110	L	120	10	2	
431177	L340	L	340	40	2	60-9211	SET109	L	135	15	2	
53-0171	SET106	L	145	10	2	60-9587	SET103	FLD	205	40	3	
53-0262	SET195	L	120	10	2	63-1375	SET137	L	130	15	2	
53-0263	SET106	L	145	10	2	63-1458	SET106	L	145	10	2	
53-0306	SET115	L	240	40	2	63-1551	SET121	LD	145	20	3	
53-0700	SET106	L	145	10	2	63-1552	L130	L	130	15	2	
53-0771	SET176	L	248	80	2	63-2825	SET133	F	300	50	2	
53-1037	SET176	L	248	80	2	63-3301	L130	L	130	15	2	
53-1095	SET106	L	145	10	2	63-3988	L255	L	255	40	2	
53-1096	SET404	SLF	240	40	2	63-3989	L255	L	255	40	2	
53-1107	SET196	L	146	25	2	63-4574	L155	L	155	20	2	
53-1182	SET403	SLS	240	40	2	63-5254	L340	L	340	40	2	
53-1459	SET176	L	248	80	2	63-5256	L340	L	340	40	2	
53-1459	SET176	L	248	80	2	63-5532	SET105	L	140	10	2	
53-2754	L14520W	LW	145	20	4	63-5533	L155	L	155	20	2	
60-2385	L200	L	200	40	2	63-6187	L340	L	340	40	2	
60-2386	L180-40	L	180	40	2	63-6305	SET105	L	140	10	2	
60-2390	L125	L	125	10	2	63-6306	SET163	L	155	20	2	
60-2713	L200	L	200	40	2	70-2548	SET176	L	248	80	2	
60-4324	SET105	L	140	10	2	73-0062	SET109	L	135	15	2	
60-4326	SET109	L	135	15	2	73-0063	SET109	L	135	15	2	
60-4327	L200	L	200	40	2	73-0065	SET109	L	135	15	2	
60-4941	L180-40	L	180	40	2	73-0155	SET109	L	135	15	2	
60-5182	L200	L	200	40	2	LA-1035	SET195	L	120	10	2+	
60-7180	SET109	L	135	15	2	31001088	L14520W	LW	145	20	4	
60-7420	LD130	LD	130	15	3	31001192	L14520W	LW	145	20	4	

Maytag

490P3 Kit SET200



Fuse and High Limit Kit
R9900489 kit is used with 61927
For High Limit only order 62641 (FL225)
For Thermal fuse only order 40113801 (SET182)

LA1053 SET405



Fuse and High Limit Kit for Gas & Electric
For High Limit only order 53-0771 (SET176)
For Thermal Fuse only order 53-1182 (SET403)
For Gas High Limit only order 53-1096 (SET404)

Dryer Parts

Maytag

**306604
SET408**



**Disc Style Thermal Fuse
Rated 84°C 183°F**

**307473
SET409**



**Disc Style Thermal Fuse
Rated 117°C 243°F**

**33001762
SET407**



**Oblong Style Thermal Fuse
Rated 84°C 183°F**

“M” Series Gas Valves

White Rodgers Direct Replacement Gas Valve Kit

**White
Rodgers**

Designed by White Rodgers to replace the “M” series clothes dryer valves. Each kit is a direct replacement valve with 8 orifices (6 Natural Gas & 2 LP), 2 bushings, and 2 nuts.



**25M01A-101
Right Angle Left Outlet**

OEM No.	Supco No.	Orifice Size
58804	25M01A-100	*#44 (.086)
60353	25M01A-100	*#40 (.098)
60667	25M01A-100	#40 (.098)
62959	25M01A-100	#44 (.086)
306084	25M01A-100	#45 (.082)
306176	25M01A-101	#43 (.089)
308345	25M01A-101	#41 (.096)
308541	25M01A-101	#41 (.096)
308542	25M01A-101	Kit
53-2908	25M01A-101	#56 (.0465)
53-3288	25M01A-101	#46 (.081)
63-6786	25M01A-101	*#46 (.081)



**25M01A-100
Right Angle Right Outlet**

*Note: Match orifice to original or use old orifice. Older or Special applications may require use of old orifice holder, mounting hardware, and pipe nipple.

Need a replacement coil kit for the “M” series valve?

Both Coils in a Kit

Booster / Holding Coil (3 terminals)

Secondary Coil (2 terminals)

OEM No.	Supco No.	OEM No.	Supco No.	OEM No.	Supco No.
12001349	DE382WR	306106	DE382AW	306105	DE382BWR
66-6615	DE382WR	58804A	DE382AWR	58804B	DE382BWR



DE382WR



DE382AWR





DE382BWR



This genuine White Rodgers valve kit is designed to replace all right angle left outlet 25M series valves.

Dryer Parts

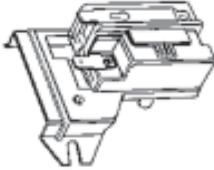
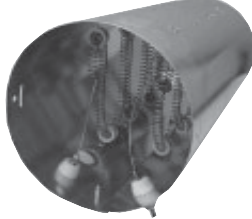
Maytag

<p>303318 ES16200</p>	<p>303376 SDE350</p>	<p>303377 DE353</p>	<p>303404 DE138</p>
			
<p>Door Switch Ref: 302288, 63-5541</p>	<p>Round Igniter</p>	<p>Flame Sensor Reference: 63-5013</p>	<p>13-32 Terminal Studs 5000 Watts 240 Volts</p>

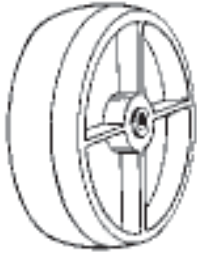
Maytag

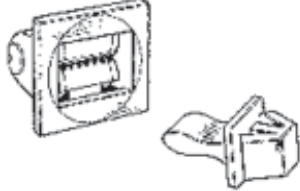
<p>303705 DE405</p>	<p>303836 DE602</p>	<p>304970 DE364</p>	<p>306436 DE902</p>
			
<p>Idler Pulley 3 1/4" Diameter</p>	<p>Blower wheel Reference: 312913</p>	<p>Flat "M" Style Igniter</p>	<p>Plastic Latch & Catch Door Kit</p>

Maytag

<p>306508 DE747</p>	<p>311534 DE739</p>	<p>311946 DE326</p>	<p>312948 DE687</p>
			
<p>Drum Glide Kit</p>	<p>Felt Drum Seal</p>	<p>1 Coil Restraining Kit 4400 Watt 240 Volts 2" Tail</p>	<p>Drum Roller Shaft Used with DE693</p>

Part numbers and illustrations are intended solely for identification. Items offered for sale are not represented to be manufactured by the company that built the original model.

Dryer Parts

Exact Replacement Dryer Parts

Maytag

313538
DE327

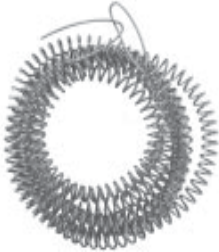

1 Coil Restring Kit
5000 Watt 240 Volts
2" Tail

53-0197
DE689

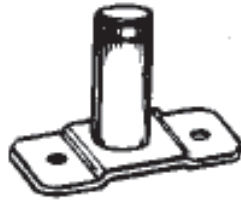

Single Support Shaft
Used with 53-1578
See LA1008 for Assembly

53-0665
DE700



Single Drum Roller
Used with 53-0198
See LA1007 for Assembly

53-0701
DE531



Lint Screen
3/8" Left & Right
Side Glides

Maytag

53-0918
DE530



Lint Screen
3/8" Left Glide
5/8" Right Glide

63-1170K
DE782

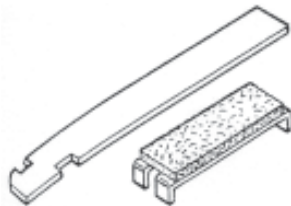

Drum Glide Kit
Includes: Pad & Glide
Used 1969 to 1971

63-1195C
DE247



1 Coil Restring Kit
5000 Watt 240 Volts
10-32 Terminals

63-3805K
DE780

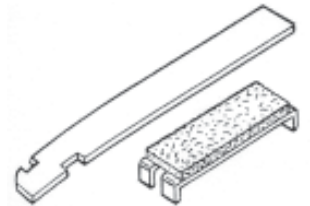

Drum Glide Kit
Includes: Pad & Glide
Used 1971 to 1981
Ref: 63-6301, 63-5719

Maytag

LA-1003
DE902M

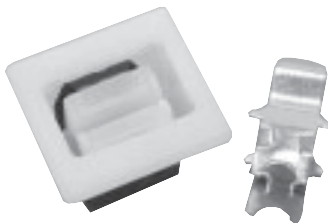

Metal Latch &
Plastic Catch
Door Kit

LA-1005
ES16600

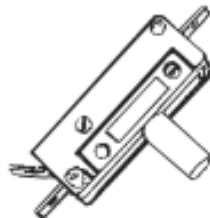

Door switch
Use Old Clip
Herrin Dryers

LA-1006
DE777

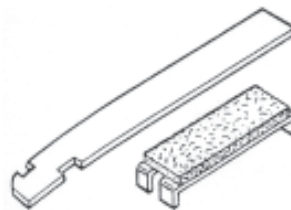

Drum Glide Kit
Includes: Pad & Glide
Reference: 53-0310N

LA-1007
DE690







Left Front
Drum Roller Kit
Reference: 53-0311N



Part numbers and illustrations are intended solely for identification. Items offered for sale are not represented to be manufactured by the company that built the original model.

Dryer Parts



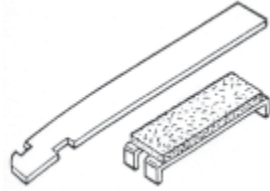
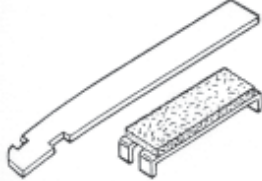

Maytag

<p>LA-1008 DE696</p>	<p>LA-1044 DE148</p>	<p>12001541 DE693</p>	<p>31001043 DE343</p>
			
<p>Drum Support Kit Reference: 53-0312N</p>	<p>Dryer Element 4750 Watts 240 Volts 1/4" Q.C. Terminals</p>	<p>Drum Roller Kit Roller & 2 washers Used with 312948 Reference: 303373</p>	<p>Blower Wheel 5/16" Shallow Shaft</p>

Maytag

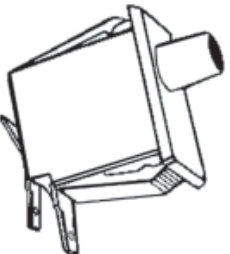
<p>31001096 DE692</p>	<p>31001469 DE786</p>	<p>31001470 DE785</p>	<p>33001167 DE532</p>
			
<p>Drum Roller Used in LA-1008</p>	<p>Left Side Glide Kit 6 7/8" X 5/8" Reference: 53-2272</p>	<p>Right Side Glide Kit 5 3/4" X 5/8" Reference: 53-2273</p>	<p>Lint Screen Not Symmetrical with magnet</p>

Maytag

<p>33001506 ES16806</p>	<p>33001808 DE534</p>	<p>33002970 DE533</p>	<p>33001003 DE529</p>
			
<p>Door Switch 3 Terminals</p>	<p>Lint Screen Newer Models</p>	<p>Lint Screen Not Symmetrical Reference: 33001171</p>	<p>Lint Screen Symmetrical Reference: 53-2045</p>

Part numbers and illustrations are intended solely for identification. Items offered for sale are not represented to be manufactured by the company that built the original model.

Dryer Parts

Whirlpool

Dryer Thermostats

OEM No.	Supco No.	Style	Temp.°F	Diff.°F	Term
279044	SET117	LD	155	20	3
279046	SET117	LD	155	20	3
279048	SET103	FLD	205	40	3
279050	SET118	LD	240	45	3
279052	SET144	LD	255	40	3
279054	SET149	LD	290	40	3
279080	SET119	LD	225	40	3
339908	SET119	LD	225	40	3
341371	SET123	LD	130	15	3
344395	SET153	LD	135	15	3
689935	SET122	LD	200	40	3
694674	SET177	L	Adjustable		2
696818	SET113	L	205	40	2
3387134	L15525W	Multi	155	25	3
3387138	L15510W	Multi	155	10	3
3390291	SET198	L	250	60	2
3391381	SET201	L	Adjustable		2
3398128	L14520W	Multi	145	20	3
3149653	SET175	FL	220	40	2
3403140	SET104	FL	205	40	2



Style FL



Style L



Style FLD



Style LD



Style Multi

Specialty Thermostats & Fuses

279769

SET184

Thermostat Kit
with 352°F Fuse



SET184 & SET194

279816

SET194

Thermostat Kit
with 325°F Fuse

196° F Thermal Fuses



330719
SET402



3392519
SET401



3399849
SET410

3977767

SET185

Thermostat only
L250-80



SET197

(3977767 w/ 325°F Fuse)
Thermostat Kit

"M" Series Gas Valves

White Rodgers Direct Replacement Gas Valve Kit

Designed by White Rodgers to replace the "M" series clothes dryer valves. Kit shown is a right angle left outlet valve (RAL). Kit is a direct replacement valve with 8 orifices (6 Natural Gas & 2 LP), 2 bushings, and 2 nuts. Valve is a direct replacement, correct orifice included. Used since 1984.



Replacement Valves	
OEM No.	Supco No.
279888	25M01A-101
279923	25M01A-100

White
Rodgers



Need a replacement coil kit for the "M" series valve?

Both Coils in a kit

For Whirlpool 279834 order the direct replacement coil

Booster / Holding Coil (3 terminal)

For Whirlpool 695398 order the direct replacement coil

Secondary Coil (2 Terminal)

For Whirlpool 695397 order the direct replacement coil

Note: Match orifice to original or use old orifice. Special applications may require use of old orifice holder. Example: The 80281911 uses a 2.4 mm orifice.

This genuine White Rodgers valve kit is designed to replace all right angle left outlet 25M series valves.

Dryer Parts

Whirlpool

230131
DE901



Dryer Door Cable

239087
DE737



Rear Drum Felt Seal
26" Dia. 82" Long

239453
ES16400

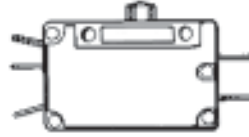

5 Wire Motor Switch
Replaces: 230652
1/4" Q.C. Terminals

239477
DE418

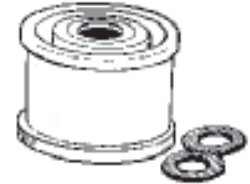

Idler Roller for
Old Style Idler

Whirlpool

239173
LP173



Push-to-start Switch Kit
1/4" Q.C. Terminals

279137
DE381

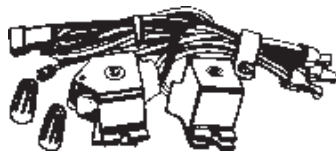

"K" Series
Split Coil Kit
Used prior to 1984

279264
DE735

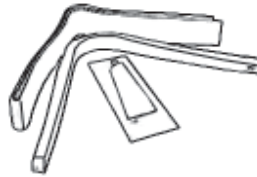

Front Bearing
Support Kit
Used with 3394508
and 3394509

279408
DE768

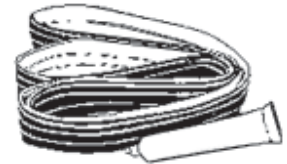

Rear Drum Felt Seal
25" Dia. 79" Long

Whirlpool

279455
DE180

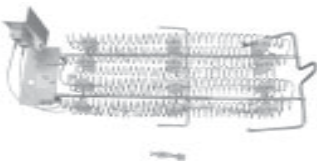

Dryer Element
5200 Watts 240 Volts
5/16" Push-on

279570
DE902M

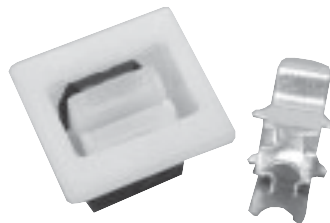

Latch & Catch Kit
Metal Latch
Plastic Catch

279598
DE195

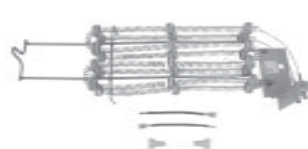

Dryer Element
5200 Watts 240 Volts
5/16" Push-on

279782
LP210



Door Switch Kit
Order LP985 (691581)
for lever only

Part numbers and illustrations are intended solely for identification. Items offered for sale are not represented to be manufactured by the company that built the original model.

Dryer Parts

Whirlpool

279787
SM279787



Replaces

3387185 3391891
3388237 3391893
3388238 3395654
3391890 3395656

Drive Shaft 1 5/8"
Blower Shaft 1 1/4"

279838
DE838

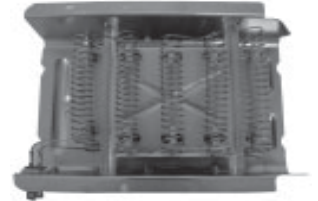

Used on front blower models prior to 1995
If you have a 1995 or 1996 model check shaft dimensions.

Dryer Element
Reference: 53-0312N

Whirlpool

279827
SM279827

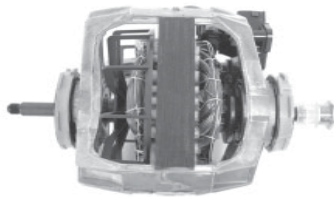

Replaces

299992
695925
& 39 SKU's

Drive Shaft 1 3/4"
Blower Shaft 1 3/4"

303919
ES16100

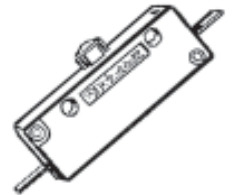

Used on front blower models prior to 1995
If you have a 1995 or 1996 model check shaft dimensions.

Door Switch
3 Wire Long Stem

Whirlpool

338906
DE353



Infrared
Flame Sensor

339392
DE522



Lint Screen
Brown
18 1/4" X 7 1/8"
Replaces: 690634

339489
DE686



Right Side
Drum Roller Shaft
Used with 349241

339491
DE904





Tri-Ring
for Drum Roller Shaft
Used with 349241



Part numbers and illustrations are intended solely for identification. Items offered for sale are not represented to be manufactured by the company that built the original model.

Dryer Parts

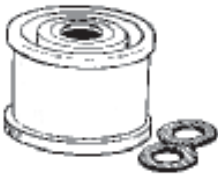
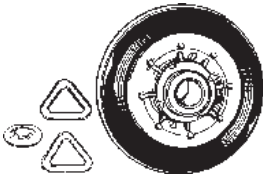

Whirlpool

<p>339489 DE686</p>	<p>342601 DE905</p>	<p>347226 DE418</p>	<p>349241 DE702</p>
			
<p>Right Side Drum Roller Shaft Used with 349241</p>	<p>Metal Panel Clip 2 (per pack)</p>	<p>Idler Pulley for Old Style 688166</p>	<p>Drum Roller Used with 339489 Right or 3399506 Left Shaft</p>

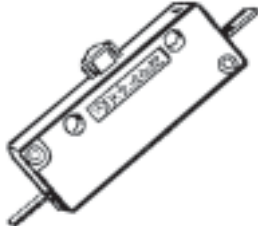
Whirlpool

<p>349241T DE702T</p>	<p>349639 DE525</p>	<p>355519 LP218</p>	<p>674819 ES16100</p>
			
<p>Same as 349241 except 2 Roller Set</p>	<p>Lint Screen Brown 20 3/4" X 7 1/2"</p>	<p>Chrome Timer Knob 1/4 - 20 threads Replaces White 355643</p>	<p>Door Switch 1/4" Push-on</p>

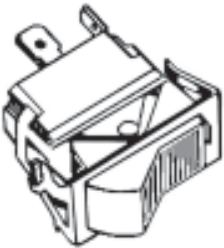
Whirlpool

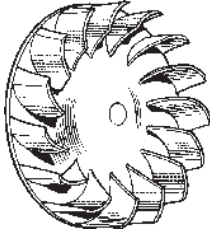
<p>686605 ES15907</p>	<p>691366 DE411</p>	<p>691581 LP985</p>	<p>694089 DE601</p>
			
<p>Air - Heat Rocker Switch 1/4" Push-on</p>	<p>Idler Arm Assembly Heavy Duty Style Reference: 688166</p>	<p>LP985D for 12 pack Lever for Door Switch for complete Assembly Order LP210</p>	<p>Blower Wheel Mounts on Motor Used in Models with Top Lint Screen Rep: 279711 & 695499</p>

Part numbers and illustrations are intended solely for identification. Items offered for sale are not represented to be manufactured by the company that built the original model.

Dryer Parts

Whirlpool			
<p>3387477 DE7477</p>  <p>Dryer Element 5/16" Terminals 5400 Watts 240 Volts New Style for Front Blower Models</p>	<p>3399506 DE685</p>  <p>Left Side Drum Roller Shaft Used with 349241</p>	<p>4391960 DE698</p>  <p>Dryer Element 5/16" Terminals 5200 Watts 240 Volts Includes 279457 adapter wires</p>	
Whirlpool			
<p>4391996 SDE364</p>  <p>Universal Flat Igniter "M" style with connector , wire nut kit included</p>	<p>4392003 SDE350</p>  <p>Universal Round Igniter Old "Wing" Style</p>		
Whirlpool			
<p>4392065 DE702K</p>  <p>Dryer Rebuild Kit Belt, Idler, & Drum Rollers</p>	<p>8536974 DE702HD</p>  <p>Heavy Duty Drum Roller Replaces front or rear on front blower models</p>	<p>8557882 DE526</p>  <p>Lint Screen White 22 1/4" X 7 1/8"</p>	<p>8667884 DE524</p>  <p>Lint Screen White 20 3/4" X 7 1/8" Replaces: 348855</p>

Part numbers and illustrations are intended solely for identification. Items offered for sale are not represented to be manufactured by the company that built the original model.

Universal Thermostats



Rollout Switches

Features/Benefits

- Auto and Manual Reset
- Offered in a broad temperature range to cover most heating applications
- Use 36T Electrical Ratings

Applications

- Automatic or Manual Rollout safety in gas fired furnaces, unit heater and roof top units.

THERMODISC



Small Flush Mount SPST Limit Thermostats

(Flush Mount Automatic Rollout)

Supco No.	Terminals	Cut Out	Cut In	Differential
SLF130-VA	Vertical 1/4"	130	115	15
SLF155-VA	Vertical 1/4"	155	115	40
SLF158-VB	Vertical 3/16"	158	118	40
SLF165-VA	Vertical 1/4"	165	125	40
SLF170-VA	Vertical 1/4"	170	130	40
SLF185-VB	Vertical 3/16"	185	145	40
SLF190-HA	Horizontal 1/4"	190	150	40
SLF194-HB	Horizontal 3/16"	194	154	40
SLF194-VB	Vertical 3/16"	194	154	40
SLF200-HA	Horizontal 1/4"	200	160	40
SLF200-VA	Vertical 1/4"	200	160	40
SLF210-HA	Horizontal 1/4"	210	170	40
SLF222-VA	Vertical 1/4"	222	182	40
SLF230-HA	Horizontal 1/4"	230	190	40
SLF230-HB	Horizontal 3/16"	230	190	40
SLF250-HA	Horizontal 1/4"	250	200	50
SLF255-VA	Vertical 1/4"	252	202	50
SLF252-VB	Vertical 3/16"	252	202	50
SLF255-VA	Vertical 1/4"	255	205	50
SLF260-HA	Horizontal 1/4"	260	210	50
SLF275-HB	Horizontal 3/16"	275	225	50
SLF275-VB	Vertical 3/16"	275	225	50
SLF280-HB	Horizontal 3/16"	280	230	50
SLF300-HB	Horizontal 3/16"	300	250	50
SLF300-VA	Vertical 1/4"	300	250	50
SLF330-VA	Vertical 1/4"	330	280	50



Automatic Rollouts - SPST Limit Thermostats

Special 30mm Center to Center

Supco No.	Terminals	Cut Out	Cut In	Differential
SLSW210	45° angle 1/4" Terminals	210	170	40
SLSW300	45° angle 1/4" Terminals	300	250	50
SLSW300HB	Horizontal 3/16" Terminals	300	250	50
SLSW350	45° angle 1/4" Terminals	350	300	50

Automatic Rollouts - SPST Limit Thermostats

Supco NO.	Terminals	Cut Out	Cut In	Differential
SLS85	45° angle 1/4" Terminals	85	70	15
SLS120	45° angle 1/4" Terminals	120	105	15
SLS130	45° angle 1/4" Terminals	130	115	15
SLS140	45° angle 1/4" Terminals	140	100	40
SLS145	45° angle 1/4" Terminals	145	105	40
SLS150	45° angle 1/4" Terminals	150	110	40
SLS155	45° angle 1/4" Terminals	155	115	40
SLS160	45° angle 1/4" Terminals	160	120	40
SLS165	45° angle 1/4" Terminals	165	125	40
SLS170	45° angle 1/4" Terminals	170	130	40
SLS175	45° angle 1/4" Terminals	175	135	40
SLS180	45° angle 1/4" Terminals	180	140	40
SLS200	45° angle 1/4" Terminals	200	160	40
SLS250	45° angle 1/4" Terminals	250	200	50
SLS255	45° angle 1/4" Terminals	255	205	50
SLS265	45° angle 1/4" Terminals	265	215	50
SLS275	45° angle 1/4" Terminals	275	225	50
SLS285	45° angle 1/4" Terminals	285	235	50
SLS295	45° angle 1/4" Terminals	295	245	50
SLS300	45° angle 1/4" Terminals	300	250	50
SLS300HB	Horizontal 3/16" Terminals	300	250	50
SLS350	45° angle 1/4" Terminals	350	300	50

Manual Rollouts - Flush Mount

SPST Limit Thermostats

Supco No.	Terminals	Cut Out	Cut In
SRLF275VA	Vertical 1/4"	275	Manual
SRLF320VA	Vertical 1/4"	320	Manual

Manual Rollouts - SPST Limit Thermostats

Supco No.	Terminals	Cut Out	Cut In
SRL130	Vertical 1/4"	130	Manual
SRL135	Vertical 1/4"	135	Manual
SRL220	Vertical 1/4"	220	Manual
SRL230	Vertical 1/4"	230	Manual
SRL240	Vertical 1/4"	240	Manual
SRL250	Vertical 1/4"	250	Manual
SRL260	Vertical 1/4"	260	Manual
SRL300	Vertical 1/4"	300	Manual

New! HVAC Flush Mount Adjustable Airsteam Themostats



Supco No.	5/16" Airstream Insert	Adjustable Range	Differential	Brand	OEM No.
HF757	Fan - Open on Rise	70 180	30	White Rodgers	757-1
HL758	Limit - Close on Rise	110 200	30	White Rodgers Carrier	758-1 HH680316

Universal Thermostats



HVAC Flush Mount Staging Thermostat

Supco No.	Description	Cut Out	Cut In	Differential
FL50	HVAC Staging Thermostat	50	35	15
FL60	HVAC Staging Thermostat	60	45	15



Standard Mount

Adjustable AT & Flat Series

- Series covers almost 95% of heater and dryer applications
- Dial knob
- 40° adjustable range
- 1/4" quick connect terminals
- Use 60T Electrical Ratings

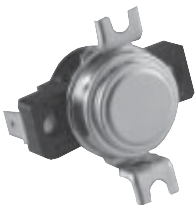

Flush Mount

THERMODISC



Adjustable Thermostats (Open on Rise)

Supco No.		Adjustable Range		Differential
Standard Mount	Flush Mount			
AT012	FLAT012	135	175	20
AT013	FLAT013	175	215	40
AT014	FLAT014	210	250	40
AT015	FLAT015	250	290	40

Adjustable Airflow Thermostats (Close on Rise)

Supco No.		Adjustable Range		Differential
Standard Mount	Flush Mount			
AT021	FLAT021	90	130	20
AT022	FLAT022	140	180	20

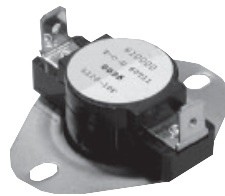

Fan Control* - Close on Rise

Supco No.	Description	Cut In	Cut Out	Differential
SHF90	Fan	90	80	10
SHF110	Fan	110	90	20
SHF110DC	Fan - Deep Cup	110	90	20
SHF120	Fan	120	110	10
SHF130	Fan	130	115	15
SHF140	Fan	140	120	20
SHF150	Fan	150	130	20
SHF160	Fan	160	140	20
SHF170	Fan	170	150	20
SHF180	Fan	180	150	30
SHF200	Fan	200	180	20
SHF250	Fan	250	220	30

*Adapter Flange Plate included with each thermostat.

*Use 60T Electrical Ratings

Limit Control* - Open on Rise

Supco No.	Description	Cut Out	Cut In	Differential
SHL120	Limit - Open on Rise	120	110	10
SHL140	Limit - Open on Rise	140	100	40
SHL150	Limit - Open on Rise	150	110	40
SHL160	Limit - Open on Rise	160	120	40
SHL170	Limit - Open on Rise	170	130	40
SHL180	Limit - Open on Rise	180	140	40
SHL190	Limit - Open on Rise	190	150	40
SHL200	Limit - Open on Rise	200	160	40
SHL210	Limit - Open on Rise	210	170	40
SHL230	Limit - Open on Rise	230	190	40
SHL250	Limit - Open on Rise	250	210	40
SHL300	Limit - Open on Rise	300	250	50
SHL325	Limit - Open on Rise	325	275	50

*Adapter Flange Plate included with each thermostat.

*Use 60T Electrical Ratings



Deep Cup Limit Thermostat

Supco No.	Range		Diff°F
	Open°F	Close°F	
L135DC	135	120	15
L145DC	145	125	20
L210DC	210	170	40

*Use 60T Electrical Ratings

Universal Thermostats

THERMODISC®

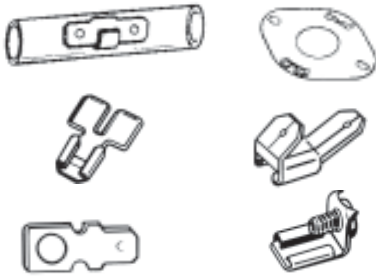

Terminal Adapters

Supco No.	Description	Where Used
HA-11	Large Flange / Airstream Adapter	60T to Oversize Flange
T1121	2 to 1 Terminal Adapter	1/4" Q.C. Female to 2 Male 1/4" Q.C. Chair Terminal
T1122	2 to 1 Terminal Adapter	1/4" Q.C. Female to 2 Male 1/4" Q.C. Side by Side Terminal
T1123	Screw to Terminal Adapter	8 - 10 Stud to 1/4" Q.C. Terminal
T1124	Terminal to Screw Adapter	1/4" Q.C. Female to Screw Right Angle Terminal
T1125	2 to 1 Terminal Adapter	1/4" Q.C. Female to 1/4" Q.C. Male Piggyback Terminal

Use 60T Electrical Ratings

Flush Mount SPST Thermostats

Supco No.	Cut Out °F	Cut In °F	Differential °F
FL135	135	120	15
FL15020	150	130	20
FL15040	150	110	40
FL155	155	125	30
FL190	190	180	10
FL200	200	160	40
FL205	205	165	40
FL220	220	180	40
FL225	225	185	40
FL240	240	190	50
FL250	250	200	50
FL260	260	210	50
FL285	295	245	50
FL320	320	270	50
FL350	350	300	50

Use 60T Electrical Ratings

Flush Mount SPDT Thermostats

Supco No.	Cut Out °F	Cut In °F	Differential °F
FLD135	135	120	15
FLD205	205	165	40

Use 60T Electrical Ratings

SPST Multi-Thermostats with Internal Heaters

Supco No.	Cut Out °F	Cut In °F	Differential °F	Thermostat Terminals	Heater Terminals	Total Terminals
L13510W	135	125	10	2 X 1/4"	2 X 3/16"	4
L13515W	135	120	15	2 X 1/4"	2 X 3/16"	4
L14515W	145	130	15	2 X 1/4"	2 X 3/16"	4
L14520W	145	125	20	2 X 1/4"	2 X 3/16"	4
L14625W	146	121	25	2 X 1/4"	2 X 3/16"	4
L15015W	150	135	15	2 X 1/4"	2 X 3/16"	4
L15025W	150	125	25	2 X 1/4"	2 X 3/16"	4
L15515W	155	140	15	2 X 1/4"	2 X 3/16"	4
L15525W	155	130	25	2 X 1/4"	2 X 3/16"	4
L21030W	210	180	30	2 X 1/4"	2 X 3/16"	4

Use 60T Electrical Ratings

SPDT Multi-Thermostats with Internal Heaters

Supco No.	Cut Out °F	Cut In °F	Differential °F	Thermostat Terminals	Heater Terminals	Total Terminals
LD14520W	145	125	20	3 X 1/4"	2 X 3/16"	5
LD15025W	150	125	25	3 X 1/4"	2 X 3/16"	5
LD15510W	155	145	10	3 X 1/4"	2 X 3/16"	5
LD15525W	155	130	25	3 X 1/4"	2 X 3/16"	5

Use 60T Electrical Ratings

Universal Thermostats



General Purpose L & LD Series

- Open on rise
- Close when temperature differential is reached
- 1/4" quick disconnect terminals
- Use 60T Electrical Ratings

Applications

- Most home laundry dryers
- Fan and Limit Applications

THERMODISC



UL RECOGNIZED

“L” Series, Single Pole - Single Throw

Supco No.	°Diff.	Open (°F)	Close (°F)
L120	10	120	110
L125	10	125	115
L130	15	130	115
L135	15	135	120
L140	20	140	120
L145	20	145	125
L150	20	150	130
L155	20	155	135
L160	20	160	140
L165	20	165	145
L170	20	170	150
L175	20	175	155
L180-20	20	180	160
L180-40	40	180	140
L190	40	190	150
L200	40	200	160
L205	40	205	165
L225	40	225	185
L240	40	240	200
L250	40	250	210
L260	40	260	220
L270	40	270	230
L290	40	290	250
L300	40	300	260
L320	40	320	280
L340	40	340	300

Typical Electrical Ratings

36T Electrical Ratings

VAC	Resistive (Non-Inductive)	Motor Rating (Inductive)		Pilot Duty
		Full Load	Locked Rotor	
120	15A	3A	12A	125 VA
240	10A	1.5A	6A	125 VA

350°F Max Ambient Temperature











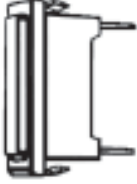
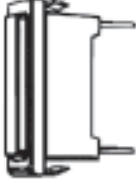
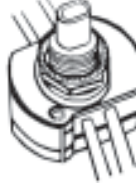
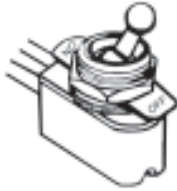





60T Electrical Ratings

VAC	Resistive (Non-Inductive)	Motor Rating (Inductive)		Pilot Duty
		Full Load	Locked Rotor	
120	25.0A	14.0A	72.0A	125 VA
240	25.0A	10.0A	60.0A	125 VA

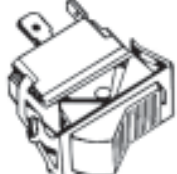
350°F Max Ambient Temperature

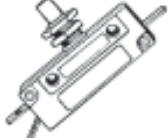

Supco No.	Cut Out °F	Cut In °F	Differential °F
LD120	120	105	15
LD130	130	115	15
LD135	135	120	15
LD140	140	120	20
LD145	145	125	20
LD155	155	135	20
LD170	170	150	20
LD190	190	170	20
LD200	200	160	40
LD210	210	170	40
LD225	225	185	40
LD240	240	200	40
LD270	270	230	40
LD290	290	250	40
LD305	305	265	40

Appliance Switches

ES15502 Pilot Light Rectangular Red Lens Replaces: 15502, 155-2 Watts 1/3 Volts 250 Mount Snap in 	ES15601 Pilot Light Rectangular Amber Lens Replaces: 15601, 156-1 Watts 1/3 Volts 125 Mount Snap in 	ES15801 Flourescent Light Switch Metal Push Button Replaces: 15801, 158-1 Watts 40 Volts 125 Mount Pal-nut 	ES15803 Toggle Switch Panel style toggle On- Off Replaces: 15803, 158-3 Amps 3 amps Volts 125 / 250 Mount Pal-nut 	ES15805 Appliance Switch White Rectangular Replaces: 15805, 158-1 Amps 20 / 10 amps Volts 125 / 250 Mount Snap in 
ES15806 Toggle Switch Panel style toggle On- Off heavy duty Replaces: 15806, 158-6 Amps 20 / 10 amps Volts 125/250 Mount Pal-nut 	ES15807 Toggle Switch Panel style toggle On - On 3 terminal Replaces: 15807, 158-7 Amps 20 / 10 amps Volts 125/250 Mount Pal-nut 	ES15810 Toggle Switch Panel style toggle On -Off - On 3 terminal Replaces: 15810, 158-10 Amps 15 amps Volts 125/250 Mount Pal-nut 	ES15811 Toggle Switch SPDT Heavy Duty Switch, typically used on GE Dishwashers, and others. Replaces: 15811, 158-11 Amps 15 amps Volts 125/250 Mount Pal-nut 	ES15813 Toggle Switch Panel style toggle On - Off - On 6 terminal Replaces: 15813, 158-13 Amps 15 amps Volts 125/250 Mount Pal-nut 
ES15901 Panel Rocker Switch Panel style Rectangular Black, Fan / On - Off Replaces: 15901, 159-1 Amps 7.5 / 10 amps Volts 125 / 250 Mount Snap in 	ES15902 Panel Rocker Switch Panel style Rectangular Black, Light / On - Off Replaces: 15902, 159-2 Amps 7.5 / 10 amps Volts 125 / 250 Mount Snap in 	ES15903 Panel Rocker Switch Panel style Rectangular Black, On - Off Replaces: 15903, 159-3 Amps 7.5 / 10 amps Volts 125 / 250 Mount Snap in 	ES15905 Panel Rocker Switch Rectangular Black, On - Off - On 3 terminal Replaces: 15905, 159-5 Amps 7.5 / 10 amps Volts 125 / 250 Mount Snap in 	ES15907 Panel Rocker Switch Rectangular White, On - On 3 terminal Replaces: 15907, 159-7 Amps 15 amps Volts 125 / 250 Mount Snap in 
ES16100 Appliance Switch SPST - Normally Open .250 Pushon Replaces: 16100, 161, 793085 WD21X557, 3135-0006 Amps 15 amps Volts 125 / 250 Mount Snap in 	ES16200 Appliance Switch SPDT - .250 Pushon Threaded or Bolt Replaces: 16200, 162 Amps 15 amps Volts 125 / 250 Mount Snap in 	ES16300 Appliance Switch SPDT - .250 Pushon Lever included Replaces: 16300, 163 Amps 15 amps Volts 125 / 250 Mount Snap in 	ES16301 Appliance Switch SPDT - .250 Pushon Lever included Replaces: 16301, 163-1 Amps 15 amps Volts 125 / 250 Mount Snap in 	ES16400 Appliance Switch DPDT - .250 Pushon Lever included Replaces: 16400, 164 Amps 15 amps Volts 125 / 250 Mount Snap in 



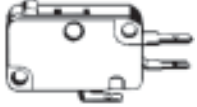
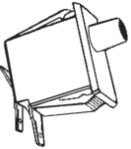



Part numbers and illustrations are intended solely for identification, Items offered for sale are not represented to be manufactured by the company that built the original equipment manufacturer, actual product may vary from illustration.

Appliance Switches

ES16600 Appliance Switch	ES16802 Appliance Switch	ES16806 Appliance Switch	ES16807 Appliance Switch	ES16814 Appliance Switch
SPDT - .250 Pushon Longer Stem Switch	Icemaker, Microwave, Vending 3/16" Terminals.	Dryer Door Switch Fits both Older and Newer models	SPST Heavy Duty Switch, typically used on S.Q., Maytag, & Commercial	Acts like lever or roller Vending, Microwave, 3/16" Terminals.
Replaces: 16600, 166, 30391	Replaces: 16802, 168-2	Replaces: 16806, 168-6, 304575, 304576	Replaces: 16807, 168-7, 0616353236, 305754	Replaces: 16814, 168-14, 625851, 627512
Amps 15 amps	Amps 15 amps	Amps 10 / 5 amps	Amps 25 amps	Amps 15 amps
Volts 125 / 250	Volts 125 / 250	Volts 125 / 250	Volts 125 / 250	Volts 125 / 250
Mount Bolt	Mount Bolt	Mount Snap in	Mount Bolt	Mount Snap in
				

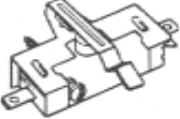
Part numbers and illustrations are intended solely for identification, Items offered for sale are not represented to be manufactured by the company that built the original equipment manufacturer, actual product may vary from illustration.

Specialty Switches

Maytag 22001682 ES682	Whirlpool 279173 LP173
 New Style Lid Switch Assembly Complete with both switches and 4 amp fuse. See 204515 & 207166 for individual switches	 Universal Push - to - Start Switch Kit Break off shaft to replace 15 part numbers. Replaces 60 different part numbers if old bracket is used.
Whirlpool 279347 LP210	Whirlpool 285671 ES671
 Lid Switch Assembly Order LP985 (691581) for lever only Order ES16803 for switch only.	 Lid Switch Assembly 3 Flat Terminals, 27" wire with 14" plastic sleeve Plastic sleeving can be trimmed to length.
Whirlpool 3949247 ES247	Whirlpool 8318084 ES8084
 Lid Switch Assembly 3 Round Terminals, 24" wire with 14" plastic sleeve Plastic sleeving can be trimmed to length.	 Lid Switch Assembly 3 Flat Terminals, Harness plugs on to switch Used on newer models.

Part numbers and illustrations are intended solely for identification, Items offered for sale are not represented to be manufactured by the company that built the original equipment, actual product may vary from illustration.

Laundry Belts by OEM No.

	Cross Section	Top Width	Height	Pitch
	2L	.25-IN	.16-IN	40°
	3L	.38-IN	.22-IN	40°
	4L	.50-IN	.31-IN	40°
	5L	.66-IN	.38-IN	40°

	Cross Section	Top Width	Height	Pitch
	A, AX	.50-IN	.31-IN	40°
	B, BX	.66-IN	.41-IN	40°
	C	.88-IN	.53-IN	40°

	Cross Section	Top Width	Height	Pitch
	3V, 3VX	.38-IN	.31-IN	38°
	5V, 5VX	.62-IN	.50-IN	38°
	7MR	Custom		

	Cross Section	Top Width	Height	Pitch
	SPZ, XPZ	9.7 MM	8 MM	38°
	SPA, XPA	12.7 MM	10 MM	38°
	SPB, XPB	16.3 MM	13 MM	38°

	Cross Section	Ridges
	J3	3
	J4	4
	J6	6
	J7	7

	Cross Section	Ridges
	H4	4
	H5	5
	H6	6

	Cross Section	Top Width
	50F	.50-IN

	Cross Section	Diameter
	6R	.19-IN
	7R	.22-IN
	8R	.25-IN

Alliance - Amana - Speed Queen - Huebsch - Unimac

OEM No	Supco No.	Cross Section	Length	UM	Surface
435P3	LB254	H4	93.5	IN	Friction
17558	LB270	J4	94	IN	Friction
20186	LB137	4X	36.5	IN	Friction
23759	LB143	3X	28	IN	Standard
27155	LB140	3L	22.4	IN	Standard
27246	LB142	4V	33	IN	Special
28808	LB142	4V	33	IN	Special
38174	LB302	4L	29.7	IN	Special
52556	LB251	J4	98	IN	Friction
55060	LB232	4R	74	IN	Standard
56095	LB270	J4	94	IN	Friction
56095P	LB270	J4	94	IN	Friction
59174	LB254	H4	93.5	IN	Friction
75098	LB231	3L	68	IN	Standard
76028	LB120	4L	30.2	IN	Standard
HT128	A43	A	43	IN	Friction
ST128	LB288	4L	67	IN	Wrapped
ST128-1	A76	A	76	IN	Wrapped
TT128	LB288	4L	67	IN	Wrapped
200063	LB302	4L	29.7	IN	Special
510178	LB254	H4	93.5	IN	Friction
511255P	LB340	H5	93.5	IN	Friction
M400607	LB288	4L	67	IN	Wrapped
M400608	A76	4L	78	IN	Wrapped
M401182	LB288	4L	67	IN	Wrapped
M406386	A61	4L	63	IN	Wrapped
M411814	A76	4L	78	IN	Wrapped
M412981	A78	4L	80	IN	Wrapped
27001006	LB302	4L	29.7	IN	Special
27001007	LB175	4L	30.8	IN	Special
40051501	LB340	H5	93.5	IN	Friction
40111201	LB254	H4	93.5	IN	Friction

Electrolux - Frigidaire - Franklin - Gibson Kelvinator - Westinghouse

OEM No.	Supco No.	Cross Section	Length	UM	Surface
63510	LB212	J3	89.5	IN	Friction
73382	LB275	J3	92	IN	Friction
78794	LB117	4L	32.5	IN	Wrapped
131654	LB210	J3	91.2	IN	Friction
133171	LB113	4L	32	IN	Wrapped
136102	LB202	J3	81	IN	Friction
139318	LB111	4L	31.5	IN	Wrapped
140801	LB210	J3	91.2	IN	Friction
141297	LB210	J3	91.2	IN	Friction
143056	LB260	50F	88	IN	Friction
144667	LB157	4L	32	IN	Wrapped
145221	LB260	50F	88	IN	Friction
145371	LB157	4L	32	IN	Wrapped
148270	LB216	H4	87.8	IN	Friction
148271	LB298	H4	89.5	IN	Friction
638957	LB201	J4	90.4	IN	Friction
639357	LB202	J3	81	IN	Friction
F63510	LB212	J3	89.5	IN	Friction
F73382	LB210	J3	91.2	IN	Friction
F78448	LB291	H4	78	IN	Wrapped
F78794	LB113	4L	32	IN	Wrapped
Q12967	LB151	3L	41.5	IN	Standard
Q12969	LB151	3L	41.5	IN	Standard
Q12970	LB150	4L	47	IN	Standard
Q62142	LB160	4L	48	IN	Cogged
Q62144	LB154	4L	53.5	IN	Standard
Q62148	LB160	4L	48	IN	Cogged
Q62149	LB151	3L	41.5	IN	Standard
Q62152	LB154	4L	53.5	IN	Standard
Q63259	LB152	3L	32	IN	Standard
Q63805	LB260	50F	88	IN	Friction
Q63806	LB260	50F	88	IN	Friction
Q63807	LB260	50F	88	IN	Friction

Laundry Belts

Electrolux - Frigidaire - Franklin - Gibson Kelvinator - Westinghouse					
OEM No.	Supco No.	Cross Section	Length	UM	Surface
Q63808	LB260	50F	88	IN	Friction
Q63809	LB260	50F	88	IN	Friction
Q63810	LB260	50F	88	IN	Friction
Q63812	LB260	50F	88	IN	Friction
11-1111	LB275	J3	92	IN	Friction
1500202	LB113	4L	32	IN	Wrapped
3004909	LB210	J3	91.2	IN	Friction
3161099	LB202	J3	81	IN	Friction
3161152	LB117	4L	32.5	IN	Wrapped
3161423	LB155	3L	32.9	IN	Standard
3203018	LB295	J6	1460	MM	Special
3204314	LB260	50F	88	IN	Friction
3204418	LB157	4L	32	IN	Wrapped
3261151	LB150	4L	47	IN	Standard
3261153	LB154	4L	53.5	IN	Standard
3261155	LB151	3L	41.5	IN	Standard
3280323	LB117	4L	32.5	IN	Wrapped
3280326	LB113	4L	32	IN	Wrapped
3281154	LB260	50F	88	IN	Friction
3283287	LB298	H4	89.5	IN	Friction
7537239	LB204	J4	89	IN	Friction
8001651	LB210	J3	91.2	IN	Friction
8001832	LB111	4L	31.5	IN	Wrapped
8002451	LB117	4L	32.5	IN	Wrapped
8004064	LB113	4L	32	IN	Wrapped
8006498	LB152	3L	32	IN	Standard
8011289	LB111	4L	31.5	IN	Wrapped
8015096	A45	A	45	IN	Friction
8015132	LB151	3L	41.5	IN	Standard
8015133	LB154	4L	53.5	IN	Standard
8027638	LB291	H4	78	IN	Wrapped
F131324	LB113	4L	32	IN	Wrapped
F131602	LB113	4L	32	IN	Wrapped
F131654	LB210	J3	91.2	IN	Friction
F133171	LB113	4L	32	IN	Wrapped
F139318	LB111	4L	31.5	IN	Wrapped
F141297	LB210	J3	91.2	IN	Friction
Q181621	LB152	3L	32	IN	Standard
Q181622	LB111	4L	31.5	IN	Wrapped
Q181623	LB111	4L	31.5	IN	Wrapped
Q181624	LB152	3L	32	IN	Standard
Q181625	LB111	4L	31.5	IN	Wrapped
Q607581	LB295	J6	1460	MM	Special
Q622451	LB155	3L	32.9	IN	Standard
131130700	LB216	H4	87.8	IN	Friction
131234000	LB117	4L	32.5	IN	Wrapped
131276300	LB295	J6	1460	MM	Special
131553800	LB216	H4	87.8	IN	Friction
131686100	LB157	4L	32	IN	Wrapped
134051000	LB295	J6	1460	MM	Special
134161100	LB117	4L	32.5	IN	Wrapped
134163400	LB216	H4	87.8	IN	Friction
134163500	LB298	H4	89.5	IN	Friction
134503600	LB216	H4	87.8	IN	Friction
134503900	LB298	H4	89.5	IN	Friction

Electrolux - Frigidaire - Franklin - Gibson Kelvinator - Westinghouse					
OEM No.	Supco No.	Cross Section	Length	UM	Surface
5300063253	LB151	3L	41.5	IN	Standard
5300063510	LB212	J3	89.5	IN	Friction
5300622451	LB155	3L	32.9	IN	Standard
5300638957	LB201	J4	90.4	IN	Friction
5300639357	LB202	J3	81	IN	Friction
5302834353	LB110	3L	31	IN	Standard
5303161099	LB202	J3	81	IN	Friction
5303161152	LB113	4L	32	IN	Wrapped
5303203018	LB295	J6	1460	MM	Special
5303261151	LB150	4L	47	IN	Standard
5303261155	LB151	3L	41.5	IN	Standard
5303276623	LB291	H4	78	IN	Wrapped
5303280326	LB113	4L	32	IN	Wrapped
5303281154	LB260	50F	88	IN	Friction
5303283287	LB298	H4	89.5	IN	Friction
5303283471	LB216	H4	87.8	IN	Friction
5304439725	LB260	50F	88	IN	Friction
5307529591	LB271	8R	90	IN	Standard
5307537239	LB204	J4	89	IN	Friction
5308001651	LB210	J3	91.2	IN	Friction
5308001832	LB111	4L	31.5	IN	Wrapped
5308002451	LB117	4L	32.5	IN	Wrapped
5308006498	LB152	3L	32	IN	Standard
5308011289	LB111	4L	31.5	IN	Wrapped
5308027638	LB291	H4	78	IN	Wrapped
5308057424	LB210	J3	91.2	IN	Friction
General Electric - Camco - Hotpoint - Mabe - Penncrest - Roper					
OEM No.	Supco No.	Cross Section	Length	UM	Surface
WE12M9	LB278	H4	79	IN	Friction
WE12M22	LB298	H4	89.5	IN	Friction
WE12M24	LB278	H4	79	IN	Friction
WE12X42	LB216	H4	87.8	IN	Friction
WE12X43	LB217	J4	99.4	IN	Friction
WE12X46	LB218	H3	68	IN	Friction
WE12X49	LB217	J4	99.4	IN	Friction
WE12X79	LB278	H4	79	IN	Friction
WE12X82	LB216	H4	87.8	IN	Friction
WE12X82R	LB216	H4	87.8	IN	Friction
WE12X85	LB202	J3	81	IN	Friction
WE12X88	LB260	50F	88	IN	Friction
WE12X93	LB278	H4	79	IN	Friction
WE12X5009	LB152	3L	32	IN	Friction
WE12X10001	LB216	H4	87.8	IN	Friction
WE12X10009	LB216	H4	87.8	IN	Friction
WE12X10011	LB276	H4	92	IN	Friction
WH1X1249	LB120	4L	30.2	IN	Standard
WH1X2026	LB120	4L	30.2	IN	Standard
WH1X2026R	LB120	4L	30.2	IN	Standard
WH1X2630	LB117	4L	32.5	IN	Standard
WH1X10031	LB120	4L	30.2	IN	Standard
WH7X86	LB117	4L	32.5	IN	Wrapped
WH7X98	LB117	4L	32.5	IN	Wrapped
WH7X113	LB157	4L	32	IN	Wrapped

Laundry Belts

Gemline (Cont.)					
OEM No.	Supco No.	Cross Section	Length	UM	Surface
LB111	LB111	4L	31.5	IN	Wrapped
LB113	LB117	4L	32.5	IN	Wrapped
LB117	LB117	4L	32.5	IN	Wrapped
LB120	LB120	4L	30.2	IN	Standard
LB125	LB125	3L	41	IN	Standard
LB126	LB126	4L	42	IN	Slip
LB127	LB127	2 Belt Set [2-11124 & 2-11125]			
LB131	LB131	SPZ	1077	MM	Standard
LB132	LB132	SPZ	1295	MM	Standard
LB140	LB140	3L	22.4	IN	Standard
LB142	LB142	4V	33	IN	Special
LB143	LB143	3L	28	IN	Standard
LB150	LB150	4L	47	IN	Standard
LB151	LB151	3L	41.5	IN	Standard
LB152	LB152	3L	32	IN	Standard
LB154	LB154	4L	53.5	IN	Standard
LB155	LB155	3L	32.9	IN	Standard
LB157	LB157	4L	32	IN	Wrapped
LB160	LB160	4L	48	IN	Cogged
LB161	LB161	7MR	47.5	IN	Cogged
LB175	LB175	4L	30.8	IN	Special
LB201	LB201	J4	90.4	IN	Friction
LB202	LB202	J3	81	IN	Friction
LB204	LB204	J4	89	IN	Friction
LB210	LB210	J3	91.2	IN	Friction
LB212	LB212	J3	89.5	IN	Friction
LB216	LB216	H4	87.8	IN	Friction
LB217	LB217	J4	99.4	IN	Friction
LB218	LB218	H3	68	IN	Friction
LB230	LB230	3L	47	IN	Standard
LB231	LB231	3L	68	IN	Standard
LB232	LB232	4R	74	IN	Standard
LB234	LB234	H5	100	IN	Friction
LB235	LB235	J3	77	IN	Friction
LB236	LB236	H4	77	IN	Friction
LB237	LB237	2 Belt Set [3-11012 & 3-11013]			
LB240	LB240	3L	74	IN	Friction
LB242	LB217	J4	99.4	IN	Friction
LB244	LB244	3L	45	IN	Friction
LB251	LB251	J4	98	IN	Friction
LB254	LB254	H4	93.5	IN	Friction
LB260	LB260	50F	88	IN	Friction
LB270	LB270	J4	94	IN	Friction
LB271	LB271	8R	90	IN	Standard
LB274	LB274	J3	94	IN	Friction
LB275	LB275	J3	93	IN	Friction
LB276	LB276	H4	92	IN	Friction
LB278	LB278	H4	79	IN	Friction
LB279	LB279	H5	92	IN	Friction
LB280	LB280	J4	58	IN	Friction
LB291	LB291	H4	78	IN	Wrapped
LB292	LB292	2X	28.5	IN	Wrapped
LB293	LB293	J7	1301	MM	Special
LB294	LB294	J6	1410	MM	Special
LB295	LB295	J6	1460	MM	Special

Gemline (Cont.)					
OEM No.	Supco No.	Cross Section	Length	UM	Surface
LB297	LB297	SPZ	1287	MM	Special
LB298	LB298	H4	89.5	IN	Friction
LB299	LB299	J6	67	IN	Special
LB300	LB300	J5	1321	MM	Special
LB301	LB301	J5	1900	MM	Special
LB302	LB302	4L	29.7	IN	Special
LB340	LB340	H5	94	IN	Friction
Maytag - Amana - Norge - Speed Queen					
OEM No.	Supco No.	Cross Section	Length	UM	Surface
20186	LB137	4X	36.5	IN	Friction
23759	LB143	3X	28	IN	Standard
27155	LB140	3L	22.4	IN	Standard
28808	LB142	4V	33	IN	Special
37820	LB175	4L	30.8	IN	Special
38174	LB302	4L	29.7	IN	Special
55060	LB232	4R	74	IN	Standard
56095	LB270	J4	94	IN	Friction
59174	LB254	H4	93.5	IN	Friction
211124	LB125	3L	41	IN	Standard
211125	LB126	4L	42	IN	Slip
2-11124/25	LB127	2 Belt Set [2-11124 & 2-11125]			
2K11124/25	LB127	2 Belt Set [2-11124 & 2-11125]			
211451	LB151	3L	41.5	IN	Standard
311012	LB230	3L	47	IN	Standard
311013	LB231	3L	68	IN	Standard
3-11012/13	LB237	2 Belt Set [3-11012 & 3-11013]			
3K11012/13	LB237	2 Belt Set [3-11012 & 3-11013]			
312512	LB232	4R	74	IN	Standard
312544	LB235	J3	77	IN	Friction
312959	LB234	H5	100	IN	Friction
313328	LB236	H4	77	IN	Friction
314774	LB234	H5	100	IN	Friction
510178	LB254	H4	93.5	IN	Friction
511255	LB254	H4	93.5	IN	Friction
757073	LB233	7R	62	IN	Standard
902115	LB233	7R	62	IN	Standard
911197	LB233	7R	62	IN	Standard
33-0388	LB131	SPZ	1077	MM	Standard
33-6104	LB131	SPZ	1077	MM	Standard
33-6343	LB131	SPZ	1077	MM	Standard
33-9787	LB131	SPZ	1077	MM	Standard
35-0186	LB131	SPZ	1077	MM	Standard
35-0425	LB131	SPZ	1077	MM	Standard
35-0465	LB131	SPZ	1077	MM	Standard
35-2320	LB132	SPZ	1295	MM	Standard
35-3662	LB132	SPZ	1295	MM	Standard
3700300	LB294	J6	1410	MM	Special
3713880	LB279	H5	92	IN	Friction
43-0283	LB131	SPZ	1077	MM	Standard
53-0186	LB276	H4	92	IN	Friction
53-1080	LB276	H4	92	IN	Friction
53-1086	LB276	H4	92	IN	Friction
53-2671	LB276	H4	92	IN	Friction
60-1267	LB240	3L	74	IN	Friction

Laundry Belts

Maytag - Amana - Norge - Speed Queen (Cont.)

OEM No.	Supco No.	Cross Section	Length	UM	Surface
63-1361	LB217	J4	99.4	IN	Friction
63-3161	LB217	J4	99.4	IN	Friction
63-3862	LB217	J4	99.4	IN	Friction
63-4663	LB217	J4	99.4	IN	Friction
63-5007	LB217	J4	99.4	IN	Friction
63-5264	LB217	J4	99.4	IN	Friction
63-6035	LB244	3L	45	IN	Friction
63-6333	LB244	3L	45	IN	Friction
73-0028	LB287	H6	73	IN	Friction
12001435	LB294	J6	1410	MM	Special
12001788	LB294	J6	1410	MM	Special
12002040	LB788	J6	1410	MM	Special
12111213	LB237	2 Belt Set [3-11012 & 3-11013]			
12112425	LB127	2 Belt Set [2-11124 & 2-11125]			
21001478	LB132	SPZ	1295	MM	Standard
21352320	LB132	SPZ	1295	MM	Standard
21353662	LB132	SPZ	1295	MM	Standard
22002040	LB788	J6	1410	MM	Special
22002313	LB788	J6	1410	MM	Special
22002709	LB297	SPZ	1287	MM	Special
22003483	LB297	SPZ	1287	MM	Special
24001094	B43	B	45	IN	Wrapped
24001096	LB306	3V	35.5	IN	Wrapped
24001097	BX90	B	93	IN	Cogged
27001006	LB302	4L	29.7	IN	Special
27001007	LB175	4L	30.8	IN	Special
31001026	LB276	H4	92	IN	Friction
31531589	LB276	H4	92	IN	Friction
33001777	LB279	H5	92	IN	Friction
33002535	LB279	H5	92	IN	Friction
40051501	LB254	H4	93.5	IN	Friction
40051502	LB254	H4	93.5	IN	Friction
40053601	LB302	4L	29.7	IN	Special
40053602	LB175	4L	30.8	IN	Special
40053606	LB302	4L	29.7	IN	Special
40053607	LB175	4L	30.8	IN	Special
40111201	LB254	H4	93.5	IN	Friction
62608400	LB297	SPZ	1287	MM	Special
62706950	LB294	J6	1410	MM	Special
63700300	LB279	H5	92	IN	Friction
R0606524	LB270	J4	94	IN	Friction
R0606539	LB142	4V	33	IN	Special
R0606549	LB254	H4	93.5	IN	Friction

Meile - Novatronics

OEM No.	Supco No.	Cross Section	Length	UM	Surface
5749920	LB300	J5	1321	MM	Special
5830920	LB301	J5	1900	MM	Special

Whirlpool - Roper - Sears

OEM No.	Supco No.	Cross Section	Length	UM	Surface
16192	LB160	4L	48	IN	Cogged
16358	LB160	4L	48	IN	Cogged
91261	LB160	4L	48	IN	Cogged
95405	LB160	4L	48	IN	Cogged

Whirlpool - Roper - Sears (Cont.)

OEM No.	Supco No.	Cross Section	Length	UM	Surface
96388	LB161	7MR	47.5	IN	Cogged
217101	LB160	4L	48	IN	Cogged
227203	LB276	H4	92	IN	Friction
237555	LB270	J4	94	IN	Friction
237683	LB271	8R	90	IN	Standard
238739	LB271	8R	90	IN	Standard
287371	LB271	8R	90	IN	Standard
296326	LB271	8R	90	IN	Standard
298422	LB271	8R	90	IN	Standard
337019	LB274	J3	94	IN	Friction
337388	LB275	J3	92	IN	Friction
337942	LB271	8R	90	IN	Standard
341241	LB276	H4	92	IN	Friction
345473	LB279	H5	92	IN	Friction
345675	LB278	H4	79	IN	Friction
349533	LB279	H5	92	IN	Friction
352967	LB161	7MR	47.5	IN	Cogged
356403	LB280	J4	58	IN	Friction
660996	LB276	H4	92	IN	Friction
660997	LB276	H4	92	IN	Friction
661561	LB276	H4	92	IN	Friction
661570	LB254	H4	93.5	IN	Friction
691371	LB271	8R	90	IN	Standard
693306	LB276	H4	92	IN	Friction
694088	LB279	H5	92	IN	Friction
694416	LB276	H4	92	IN	Friction
694868	LB276	H4	92	IN	Friction
695055	LB276	H4	92	IN	Friction
697388	LB276	H4	92	IN	Friction
3387610	LB254	H4	93.5	IN	Friction
3389628	LB276	H4	92	IN	Friction
3389720	LB254	H4	93.5	IN	Friction
3389728	LB254	H4	93.5	IN	Friction
3392665	LB276	H4	92	IN	Friction
3393999	LB254	H4	93.5	IN	Friction
3394651	LB276	H4	92	IN	Friction
3394652	LB278	H4	79	IN	Friction
3394653	LB278	H4	79	IN	Friction
3399844	LB276	H4	92	IN	Friction
4319392	LB278	H4	79	IN	Friction
8066065	LB276	H4	92	IN	Friction
8181670	LB293	J7	1301	MM	Special
8182633	LB293	J7	1301	MM	Special
8562613	LB299	J6	67	IN	Special
9724037	LB299	J6	67	IN	Special
EB033ET083	LB299	J6	67	IN	Special
46197020089	LB293	J7	1301	MM	Special

Laundry Belts by Supco No.

Supco No.	Cross Section	Length	UM	Surface
LB110	3L	31	IN	Standard
LB111	4L	31.5	IN	Wrapped
LB113	4L	32	IN	Wrapped
LB117	4L	32.5	IN	Wrapped
LB120	4L	30.2	IN	Standard
LB125	3L	41	IN	Standard
LB126	4L	42	IN	Slip
LB131	SPZ	1077	MM	Standard
LB132	SPZ	1295	MM	Standard
LB137	4X	36.5	IN	Friction
LB140	3L	22.4	IN	Standard
LB142	4V	33	IN	Special
LB143	3X	28	IN	Standard
LB150	4L	47	IN	Standard
LB151	3L	41.5	IN	Standard
LB152	3L	32	IN	Standard
LB154	4L	53.5	IN	Standard
LB155	3L	32.9	IN	Standard
LB157	4L	32	IN	Wrapped
LB160	4L	48	IN	Cogged
LB161	7MR	47.5	IN	Cogged
LB175	4L	30.8	IN	Special
LB201	J4	90.4	IN	Friction
LB202	J3	81	IN	Friction
LB204	J4	89	IN	Friction
LB210	J3	91.2	IN	Friction
LB212	J3	89.5	IN	Friction
LB216	H4	87.8	IN	Friction
LB217	J4	99.4	IN	Friction
LB218	H3	68	IN	Friction
LB230	3L	47	IN	Standard
LB231	3L	68	IN	Standard
LB232	4R	74	IN	Standard

Supco No.	Cross Section	Length	UM	Surface
LB233	7R	62	IN	Standard
LB234	H5	100	IN	Fric
LB235	J3	77	IN	Friction
LB236	H4	77	IN	Friction
LB240	3L	74	IN	Friction
LB244	3L	45	IN	Friction
LB251	J4	98	IN	Friction
LB254	H4	93.5	IN	Friction
LB260	50F	88	IN	Friction
LB270	J4	94	IN	Friction
LB271	8R	90	IN	Standard
LB274	J3	94	IN	Friction
LB275	J3	92	IN	Friction
LB276	H4	92	IN	Friction
LB278	H4	79	IN	Friction
LB279	H5	92	IN	Friction
LB280	J4	58	IN	Friction
LB287	H6	73	IN	Friction
LB288	4L	67	IN	Wrapped
LB291	H4	78	IN	Wrapped
LB292	2X	28.5	IN	Wrapped
LB293	J7	1301	MM	Special
LB294	J6	1410	MM	Special
LB295	J6	1460	MM	Special
LB297	SPZ	1287	MM	Special
LB298	H4	89.5	IN	Friction
LB299	J6	67	IN	Special
LB300	J5	1321	MM	Special
LB301	J5	1900	MM	Special
LB302	4L	29.7	IN	Special
LB306	3V	35.5	IN	Wrapped
LB340	H5	93.5	IN	Friction
LB788	J6	1410	MM	Special

Surface Elements

Universal Plug-in Surface Elements

- Direct replacements for thousands of models
- Meet or exceed OEM specifications
- Manufactured from high temperature stainless alloys
- Terminals are Nickel over steel “Looped Ends”
- Medallions have a high temperature black porcelain coating

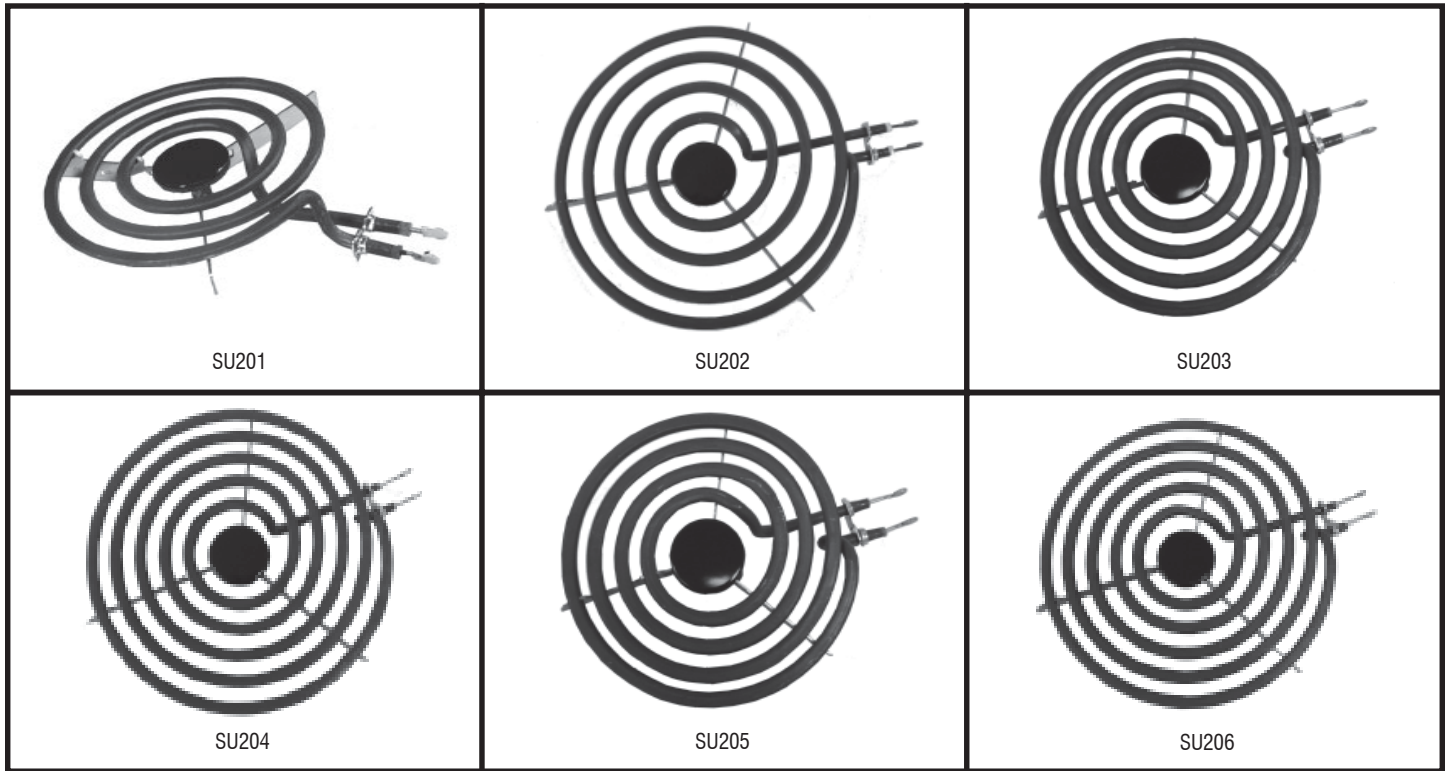

Surface Elements “Y” or “W” Spider

Supco No.	Chromalox	Watts	Volts	Turns	Size	Coils	Medallion
SU201	SP12YA	1250 / 938	240 / 208	3	6"	Single	Black
SU202	SP21YA	2100 / 1575	240 / 208	4	8"	Single	Black
SU203	MP12YA	1250 / 938	240 / 208	4	6"	Single	Black
SU204	MP21YA	2100 / 1575	240 / 208	5	8"	Single	Black
SU205	MP15YA	1500 / 1125	240 / 208	4	6"	Single	Black
SU206	MP26YA	2600 / 1950	240 / 208	5	8"	Single	Black

Surface Elements

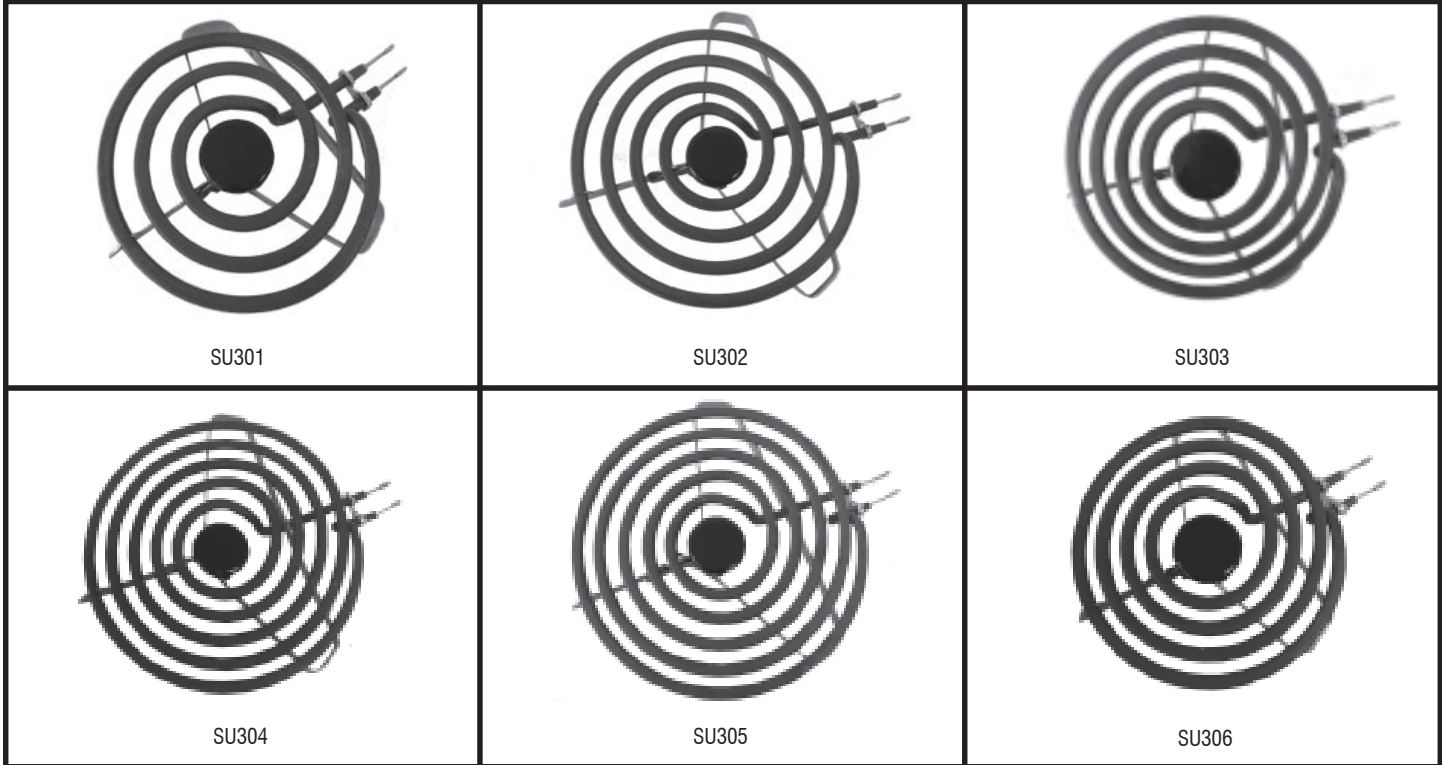

Delta Style Surface Elements

Supco No.	Chromalox	Watts	Volts	Turns	Size	Coils	Medallion
SU301	SP12MA	1250 / 938	240 / 208	3	6"	Single	Black
SU302	SP21MA	2100 / 1575	240 / 208	4	8"	Single	Black
SU303	MP12MA	1250 / 938	240 / 208	4	6"	Single	Black
SU304	MP15MA	1500 / 1125	240 / 208	4	6"	Single	Black
SU305	MP21MA	2100 / 1575	240 / 208	5	8"	Single	Black
SU306	MP26MA	2600 / 1950	240 / 208	5	8"	Single	Black

Tech Tips:

1. The SU3XX series are older and can be replaced with the SU2XX series, match size and wattage.
2. Check the terminals, if there is any sign of arcing, replace the receptacle as well to prevent call backs. Also check the receptacle wiring if brittle replace wiring.

Surface Elements

Hinged Surface Elements for GE

- Direct replacements for hundreds of models
- Meet or exceed OEM specifications
- Manufactured from high temperature stainless alloys
- Ceramics and screws are included

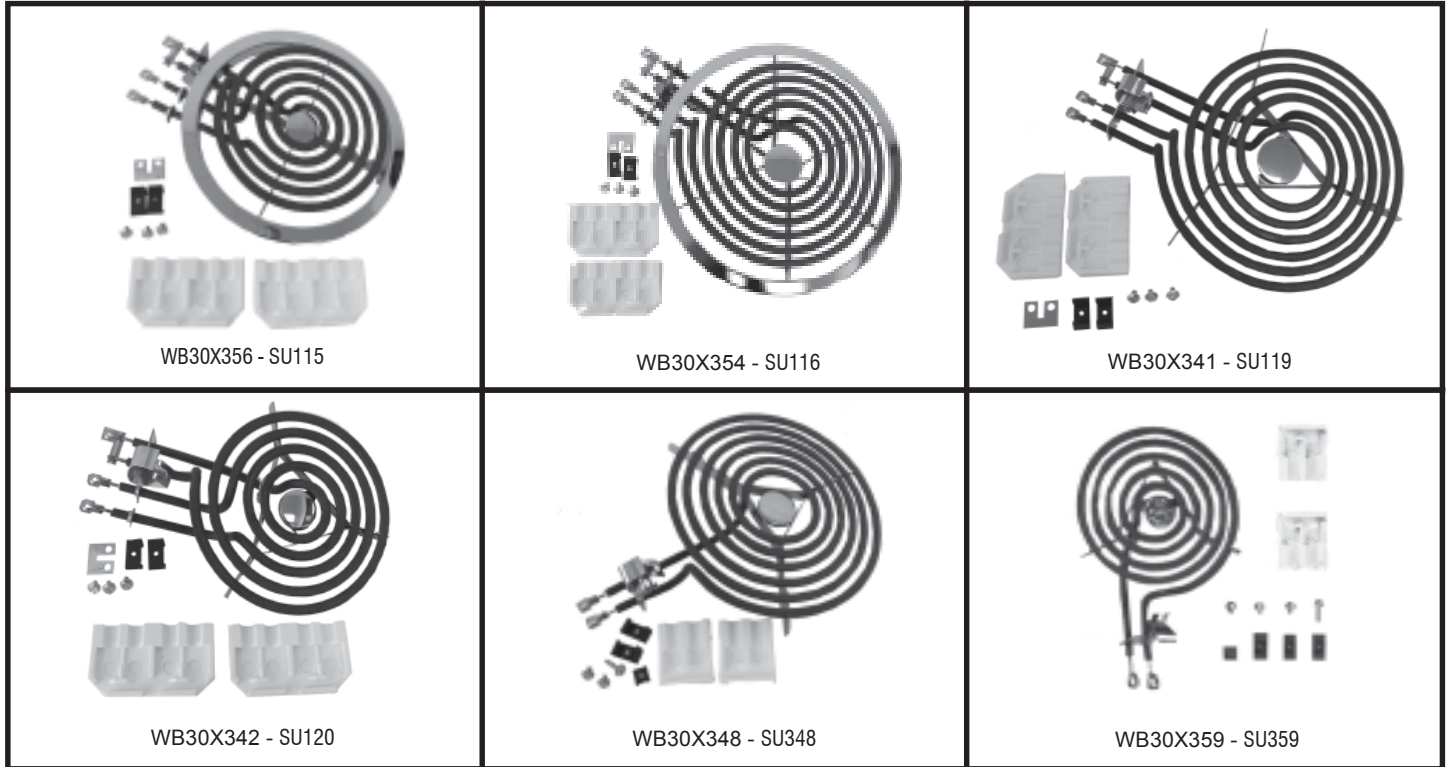

G.E. NO.	Supco No.	Watts	Volts	Turns	Size	Coils	Medallion
WB30X341	SU119	2450 / 1838	240 / 208	6	8"	Double	S/S
WB30X342	SU120	1350 / 1013	240 / 208	5	6"	Double	S/S
WB30X348	SU348	1350 / 1013	240 / 208	5	6"	Single	S/S
WB30X354	SU116	2450 / 1838	240 / 208	5	8"	Double	S/S
WB30X356	SU115	1350 / 1013	240 / 208	6	6"	Double	S/S
WB30X359	SU359	2350 / 1763	240 / 208	6	8"	Single	S/S

Surface Elements



WB30X218 - SU117



WB30X219 - SU118



WB30M1 - SU121



WB30M2 - SU122

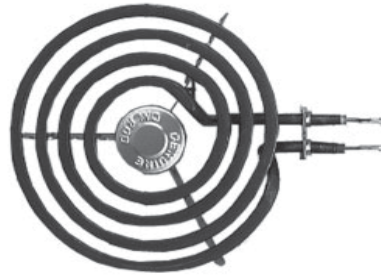

WB30T10078 - SU150

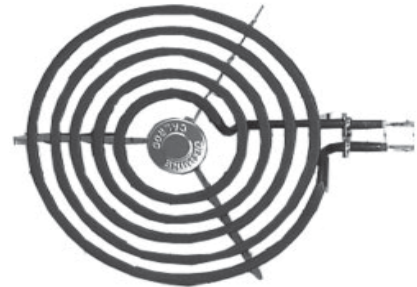

WB30T10074 - SU151

Plug-in Surface Elements for GE

General Electric	Supco No.	Watts	Volts	Turns	Size	Coils	Medallion
WB30M1	SU121	1325 / 994	240 / 208	5	6"	Single	S/S
WB30M2	SU122	2350 / 1763	240 / 208	6	8"	Single	S/S
WB30T10074	SU151	2350 / 1763	240 / 208	5	8"	Single	S/S
WB30T10078	SU150	1325 / 994	240 / 208	4	6"	Single	S/S
WB30X218	SU117	1325 / 994	240 / 208	5	6"	Single	S/S
WB30X219	SU118	2350 / 1763	240 / 208	6	8"	Single	S/S

Receptacles

Receptacles for Universal Plug-in Surface Elements

Supco No.	Electrolux	GE	Maytag	Whirlpool	Includes	Used with
RR105	5300219245	WB17X210			Horizontal mounting clip , block and 2 terminals	SU2XX & SU3XX series surface elements
RR109	5303912666				Vertical mounting clip , block, 2 wire leads, 2 wire nuts, and 2 heat shrink.	SU2XX & SU3XX series surface
RR110	5301167733	WB17X210		330031	Horizontal mounting clip , block, 2 wire leads, 2 wire nuts, and 2 heat shrink.	SU2XX & SU3XX series surface elements
RR117 RR122	5303935058	WB17X210 WB17X5051	0089336	330031	Horizontal & Vertical mounting clips, block, 2 wire leads, 2 wire nuts, and 2 heat shrink. Complete receptacle with bracket	SU2XX & SU3XX series surface elements SU117 & SU118

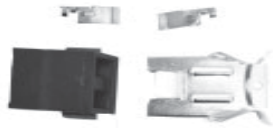

RR105

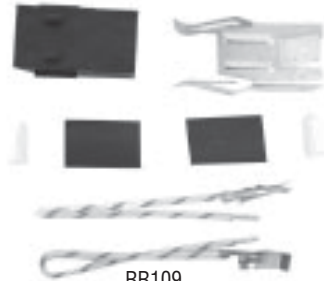

RR109



RR110



RR122

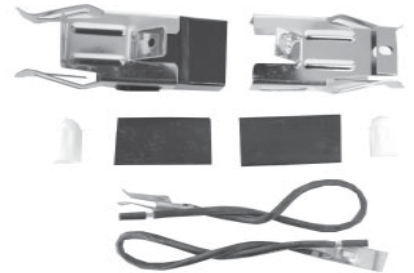

RR117

Universal Oven Thermostat Bulb Clip

Supco No.	Electrolux	GE	Maytag	Whirlpool	Includes	Used with
RR382	5303284616*	WB2X5041	7112P004-60 707234	313382*	Thermostat bulb clip for oven thermostat	Any brand thermostat that has a thermal bulb in the oven.

* Direct replacement for Electrolux & Whirlpool, universal replacement for GE & Maytag



RR382

Drip Pans, Rings & Broil Pans

Direct Replacement Trim Rings, Drip Pans, and Burner Bowls

Descriptions: Burner Bowl - A combination of a pan and trim ring all in one part

Drip Pan - A pan that fits in a trim ring (or under the ring for GE)

Trim Ring - Decorative ring that holds the pan (or covers the edge on GE)

Kit - Used here to designate a pan and ring (2 piece set)

Features:

Chromed pans and bowls are cold rolled steel with heavy chrome plating

Black pans and bowls are made from a special cold rolled steel to prevent cracking and crazing. Black pans and bowls are porcelain coated and can be cleaned in the self-cleaning cycle of the oven.

Trim Rings are manufactured from high nickel stainless steel.



DP101 & DP102
No slots



DP103
4" I.D. Center - 3 slots



DP104 & DP105
Pan fits under ring



DP106 & DP107
Deep Drawn Style



DP110 & DP111
Solid Bottom - Vertical Slot



DP112 & DP113
Vertical Slot



DP114 & DP115
DP116 & DP117
Use with trim ring



DP122
3 1/2" I.D. Center



DP125 3 grooves 3" I.D.
DP125W no grooves 4 1/2" I.D.



DP131 & DP132
Pan fits inside ring



DP133 & DP134
Alignment & Vertical Slots



DP142 & DP143
Vertical Slot

Drip Pans, Rings & Broil Pans



DP144 & DP145
DP146 & DP147
Use with trim ring



DP158
9 1/4" Wide X 9 1/8" Long
3 9/16" I.D. Center



DP159
9 7/16" Wide X 19" Long
3 9/16" I.D. Center



DP160
4" I.D. Center



DP161
Key Hole Center



DP164 & DP165
Alignment Bubble



DP166 & DP167
Bubble & Dips



DP333 & DP334
Alignment & Vertical Slots



DP364 & DP365
Alignment Bubble

Electrolux

Replaces: OEM No.	Supco No. Bagged	Supco No. Bulk	Size	Depth	Type	Style	Finish
318138500	DP147	DP247	8 1/2"	...	Pan	Electric	Black
318138501	DP146	DP246	6 1/4"	...	Pan	Electric	Black
5303131115	DP103	DP203	8 1/2"	...	Pan	Gas	Chrome
5300131961	DP116	DP216	6 1/4"	...	Bowl	Electric	Chrome
5300131964	DP117	DP217	8 1/2"	...	Bowl	Electric	Chrome
5300131986	DP131	DP231	6 1/4"	...	Ring	Electric	S/S
5300131987	DP132	DP232	8 1/2"	...	Ring	Electric	S/S
5300147221	DP106	DP206	6 5/8"	3/4"	Bowl	Electric	Chrome
5300147223	DP107	DP207	8 5/16"	3/4"	Bowl	Electric	Chrome
5303013588	DP113	DP213	8 3/16"	1/2"	Bowl	Electric	Chrome
5303207018	DP161	DP261	8 1/2"	...	Pan	Gas	Chrome
5303280336	DP112	DP212	6 5/16"	1/2"	Bowl	Electric	Chrome
5303935053	DP143	DP243	8 3/16"	1/2"	Pan	Electric	Black
5303935054	DP113	DP213	8 3/16"	1/2"	Bowl	Electric	Chrome
5303935055	DP142	DP242	6 5/16"	1/2"	Pan	Electric	Black
5303935057	DP112	DP212	6 5/16"	1/2"	Bowl	Electric	Chrome
5304432494	DP112	DP212	6 5/16"	1/2"	Bowl	Electric	Chrome
5304432495	DP113	DP213	8 3/16"	1/2"	Bowl	Electric	Chrome
5305010101	DP125W	9"	...	Pan	Gas	Chrome
5308003113	DP131	DP231	6 1/4"	...	Ring	Electric	s/s
5308003114	DP132	DP232	8 1/2"	...	Ring	Electric	s/s
5308011431	DP160	DP260	7 1/2"	...	Pan	Gas	Chrome
614T018F01	DP131	DP231	6 1/4"	...	Ring	Electric	S/S
614T018F02	DP132	DP232	8 1/2"	...	Ring	Electric	S/S

Drip Pans, Rings & Broil Pans

General Electric							
Replaces: OEM No.	Supco No. Bagged	Supco No. Bulk	Size	Depth	Type	Style	Finish
330685	DP113	DP213	8 3/16"	1/2"	Bowl	Electric	Chrome
330686	DP112	DP212	6 5/16"	1/2"	Bowl	Electric	Chrome
332299	DP125	DP225	9"	...	Pan	Gas	Chrome
345007	DP166	DP266	6 3/8"	3/8"	Bowl	Electric	Chrome
345008	DP167	DP267	8 1/2"	3/8"	Bowl	Electric	Chrome
WB31M2	DP113	DP213	8 3/16"	1/2"	Bowl	Electric	Chrome
WB31M1	DP112	DP212	6 5/16"	1/2"	Bowl	Electric	Chrome
WB31M15	DP165	DP265	8 1/2"	3/8"	Bowl	Electric	Chrome
WB31M16	DP164	DP264	6 3/8"	3/8"	Bowl	Electric	Chrome
WB31M19	DP365	DP465	8 1/2"	3/8"	Bowl	Electric	Black
WB31M20	DP364	DP464	6 3/8"	3/8"	Bowl	Electric	Black
WB32X84	DP103	DP203	8 1/2"	...	Pan	Gas	Chrome
WB32X90	DP159	DP259	9 1/4"	...	SQ.Pan	Gas	Chrome
WB32X102	DP158	DP258	9 1/2"	...	SQ.Dbl.Pan	Gas	Chrome
WB32X103	DP145	DP245	6 3/8"	...	Pan	Electric	Black
WB32X104	DP144	DP244	8 1/2"	...	Pan	Electric	Black
WB32X106	DP113	DP213	8 3/16"	1/2"	Bowl	Electric	Chrome
WB32X107	DP112	DP212	6 5/16"	1/2"	Bowl	Electric	Chrome
WB31K5024	DP166	DP266	6 3/8"	3/8"	Bowl	Electric	Chrome
WB31K5025	DP167	DP267	8 1/2"	3/8"	Bowl	Electric	Chrome
WB31K5044	DP131	DP231	6 1/4"	...	Ring	Electric	S/S
WB31K5046	DP132	DP232	8 1/2"	...	Ring	Electric	S/S
WB31K5047	DP147	DP247	6 1/4"	...	Pan	Electric	Black
WB31K5049	DP132	DP232	8 1/2"	...	Ring	Electric	S/S
WB31X5010	DP101	DP201	6 3/8"	1/4"	Bowl	Electric	Chrome
WB31X5011	DP102	DP202	8 1/2"	1/4"	Bowl	Electric	Chrome
WB31X5013	DP104	DP204	6 3/8"	...	Ring	Electric	S/S
WB31X5014	DP105	DP205	8 1/2"	...	Ring	Electric	S/S
WB31X5045	DP146	DP246	6 1/4"	...	Pan	Electric	Black
WB31X5047	DP147	DP247	8 1/2"	...	Pan	Electric	Black
WB32X5024	DP160	DP260	7 1/2"	...	Pan	Gas	Chrome
WB32X5036	DP117	DP217	6 1/4"	...	Bowl	Electric	Chrome
WB32X5045	DP116	DP216	8 1/2"	...	Bowl	Electric	Chrome
WB32X5051	DP144	DP244	6 3/8"	...	Pan	Electric	Black
WB32X5052	DP145	DP245	8 1/2"	...	Pan	Electric	Black
WB32X5069	DP365	DP464	6 3/8"	3/8"	Bowl	Electric	Black
WB32X5070	DP364	DP465	8 1/2"	3/8"	Bowl	Electric	Black
WB32X5075	DP164	DP264	6 3/8"	3/8"	Bowl	Electric	Chrome
WB32X5076	DP165	DP265	8 1/2"	3/8"	Bowl	Electric	Chrome
WB31T10010	DP164	DP264	6 3/8"	3/8"	Bowl	Electric	Chrome
WB31T10011	DP165	DP265	8 1/2"	3/8"	Bowl	Electric	Chrome
WB31T10014	DP364	DP464	6 3/8"	3/8"	Bowl	Electric	Black
WB31T10015	DP365	DP465	8 1/2"	3/8"	Bowl	Electric	Black
WB32X10012	DP114	DP214	6 3/8"	...	Pan	Electric	Chrome
WB32X10013	DP115	DP215	8 1/2"	...	Pan	Electric	Chrome
WB32X10014	DP165	DP265	8 1/2"	3/8"	Bowl	Electric	Chrome
WB32X10015	DP164	DP264	6 3/8"	3/8"	Bowl	Electric	Chrome
WB32X10017	DP112	DP212	6 5/16"	1/2"	Bowl	Electric	Chrome
WB32X10018	DP113	DP213	8 3/16"	1/2"	Bowl	Electric	Chrome

Drip Pans, Rings & Broil Pans

Maytag							
Replaces: OEM No.	Supco No. Bagged	Supco No. Bulk	Size	Depth	Type	Style	Finish
097083	DP160	DP260	7 1/2"	...	Pan	Gas	Chrome
099911	DP160	DP260	7 1/2"	...	Pan	Gas	Chrome
1430282		Order 2 each DP112 and 2 each DP113					
1430283		Order 3 each DP112 and 1 each DP113					
305837K	DP112	DP212	6 5/16"	1/2"	Bowl	Electric	Chrome
305839K	DP113	DP213	8 3/16"	1/2"	Bowl	Electric	Black
308648B	DP142	DP242	6 5/16"	1/2"	Bowl	Electric	Black
308648B	DP333	DP433	6 5/16"	1/2"	Bowl	Electric	Chrome
308648K	DP133	DP233	6 5/16"	1/2"	Bowl	Electric	Black
308649B	DP143	DP243	8 3/16"	1/2"	Bowl	Electric	Black
308649B	DP334	DP434	8 3/16"	1/2"	Bowl	Electric	Chrome
308649K	DP134	DP234	8 3/16"	1/2"	Bowl	Electric	Chrome
74001212	DP110	DP210	6 5/16"	1/2"	Bowl	Electric	Chrome
74001213	DP111	DP211	8 3/16"	1/2"	Bowl	Electric	Chrome
74004068	DP333	DP433	6 5/16"	1/2"	Bowl	Electric	Black
74001479	DP147	DP247	8 1/2"	...	Pan	Electric	Black
7725P013-60	DP146	DP246	6 1/4"	...	Pan	Electric	Black
7725P014-60	DP113	DP213	8 3/16"	1/2"	Bowl	Electric	Chrome
7725P015-60	DP112	DP212	6 5/16"	1/2"	Bowl	Electric	Chrome

Whirlpool							
Replaces: OEM No.	Supco No. Bagged	Supco No. Bulk	Size	Depth	Type	Style	Finish
229769	DP113	DP213	8 3/16"	1/2"	Bowl	Electric	Chrome
281348	DP112	DP212	6 5/16"	1/2"	Bowl	Electric	Chrome
285573	DP131	DP231	6 1/4"	...	Ring	Electric	S/S
330685	DP113	DP213	8 3/16"	1/2"	Bowl	Electric	Chrome
330686	DP112	DP212	6 5/16"	1/2"	Bowl	Electric	Chrome
332299	DP125	DP225	9" ...	Pan	Gas	Chrome	
345007	DP166	DP266	6 3/8"	3/8"	Bowl	Electric	Chrome
345008	DP167	DP267	8 1/2"	3/8"	Bowl	Electric	Chrome
814114	Kit - Order DP131 S/S Ring & DP146 Black Porcelain Pan						
814115	Kit - Order DP132 S/S Ring & DP147 Black Porcelain Pan						
834729	DP132	DP232	8 1/2"	...	Ring	Electric	S/S
834730	DP131	DP231	6 1/4"	...	Ring	Electric	S/S
868490	DP146	DP246	6 1/4"	...	Pan	Electric	Black
868491	DP147	DP247	8 1/2"	...	Pan	Electric	Black
868444	DP133	DP233	6 5/16"	1/2"	Bowl	Electric	Chrome
868447	DP134	DP234	8 3/16"	1/2"	Bowl	Electric	Chrome
3150244	DP131	DP231	6 1/4"	...	Ring	Electric	S/S
3150245	DP132	DP232	8 1/2"	...	Ring	Electric	S/S
3150246	DP133	DP233	6 5/16"	1/2"	Bowl	Electric	Chrome
3150247	DP134	DP234	8 3/16"	1/2"	Bowl	Electric	Chrome
3169204	DP333	DP433	6 5/16"	1/2"	Bowl	Electric	Black
3169205	DP334	DP434	8 3/16"	1/2"	Bowl	Electric	Black
4157865	DP110	DP210	6 5/16"	1/2"	Bowl	Electric	Chrome
4157866	DP111	DP211	8 3/16"	1/2"	Bowl	Electric	Chrome
4327709	DP112	DP212	6 5/16"	1/2"	Bowl	Electric	Chrome
4327709	DP133	DP233	6 5/16"	1/2"	Bowl	Electric	Chrome
4329225	DP113	DP213	8 3/16"	1/2"	Bowl	Electric	Chrome
4329225	DP134	DP234	8 3/16"	1/2"	Bowl	Electric	Chrome
4336679	DP146	DP246	6 1/4"	...	Pan	Electric	Black

Drip Pans, Rings & Broil Pans

Whirlpool (Cont.)							
Replaces: OEM No.	Supco No. Bagged	Supco No Bulk	Size	Depth	Type	Style	Finish
4336680	DP147	DP247	8 1/2"	...	Pan	Electric	Black
4389591	DP166	DP266	6 5/16"	1/2"	Bowl	Electric	Chrome
4389592	DP167	DP267	8 3/16"	1/2"	Bowl	Electric	Chrome
4396088	DP334	DP434	8 3/16"	1/2"	Bowl	Electric	Black
4396089	DP333	DP433	6 5/16"	1/2"	Bowl	Electric	Black
4396092	DP133	DP233	6 5/16"	1/2"	Bowl	Electric	Chrome
4396093	DP134	DP234	8 3/16"	1/2"	Bowl	Electric	Chrome
8189501	DP110	DP210	6 5/16"	1/2"	Bowl	Electric	Chrome
4212244	DP112	DP212	6 5/16"	1/2"	Bowl	Electric	Chrome
4212245	DP113	DP213	8 3/16"	1/2"	Bowl	Electric	Chrome
4324056	DP125W	9"	Pan	Gas	Chrome
4330786	DP160	DP260	7 1/2"	...	Pan	Gas	Chrome
4336770	DP125	DP225	9"	Pan	Gas	Chrome
4338568	DP158	DP258	9 1/2"	SQ.Dbl.Pan	Gas	Chrome
K15017	DP112	DP212	6 5/16"	1/2"	Bowl	Electric	Chrome
K15018	DP113	DP213	8 3/16"	1/2"	Bowl	Electric	Chrome

Economy Broiler Pan

Economy broiler pan features all steel construction, plated for easy cleaning.



Supco No.	Description
BP4000S	Steel Plated
Packaged 12 per carton	













Bake & Broil Elements

Bake & Broil Elements

- Manufactured on the same production lines as the OEM parts.
- Meet or exceed OEM specifications and are UL/CSA approved.
- The outside sheath is made of Incoloy™ a very high temperature nickel stainless alloy.
- The elements are sealed with a high temperature liquid silicone compound straight out of the annealing oven, to prevent any moisture in the element.



















Tech Tip:
 After Installing a Bake, Broil or Surface Element the element should run at full temperature for a minimum of 5 minutes. This will drive out any moisture that may have been absorbed by the element during shipping and storage.











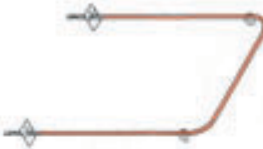



<p>RP44K5012 Bake</p> <p>Replaces: GE WB44M0001 Bracket Special Terminal 2672 Length 14 3/4" Width 17" Insert 4" Watts 2850/2138 Volts 240/208</p> 	<p>RP44X126 Bake</p> <p>Replaces: GE WB44X126 Bracket 1339 Terminal 6057 Length 14 5/8" Width 19 3/8" Insert 1 5/8" Watts 3000/2250 Volts 240/208</p> 	<p>RP44X127 Bake</p> <p>Replaces: GE WB44X196 Bracket 2598 Terminal 6057 Length 15" Width 8 1/2" Insert 1 5/8" Watts 2000/1500 Volts 240/208</p> 	<p>RP44X134 Broil</p> <p>Replaces: GE WB44X134 Bracket 1504 Terminal 6057 Length 15 1/2" Width 11 1/2" Insert 1 3/4" Watts 3000/2250 Volts 240/208</p> 
<p>RP44X164 Bake</p> <p>Replaces: GE WB44X148 Bracket 2781 Terminal 6057 Length 15 1/2" Width 17 1/2" Insert 3 1/2" Watts 3000/2250 Volts 240/208</p> 	<p>RP44X173 Broil</p> <p>Replaces: GE WB44X149 Bracket 1339 Terminal 6057 Length 15" Width 11" Insert 2 3/4" Watts 3000/2250 Volts 240/208</p> 	<p>RP44X200 Bake</p> <p>Replaces: GE WB44X160 Bracket 1339 Terminal 6057 Length 16 5/8" Width 13" Insert 2 1/2" Watts 3000/2077 Volts 250/208</p> 	<p>RP44X228 Bake</p> <p>Replaces: GE WB44X228 Bracket Special Terminal 2672 Length 15 1/2" Width 18 3/8" Insert 4" Watts 3000/2250 Volts 240/208</p> 
<p>RP44X5043 Bake</p> <p>Replaces: GE WB44X5043 Bracket 1339 Terminal 6057 Length 15 1/8" Width 13 1/2" Insert 1 1/2" Watts 3000/2250 Volts 240/208</p> 	<p>RP44X5074 Broil</p> <p>Replaces: GE WB44X5074 Bracket 2529 Terminal 6057 Length 16 3/16" Width 12 1/4" Insert 2 1/4" Watts 2750/2065 Volts 240/208</p> 	<p>RP44X5082 Bake</p> <p>Replaces: GE WB44X5082 Bracket 1339 Terminal 6057 Length 14 1/2" Width 18" Insert 2 1/2" Watts 2700/1869 Volts 250/208</p> 	<p>RP44X5083 Bake</p> <p>Replaces: GE WB44X5083 Bracket 1339 Terminal 6057 Length 14 1/2" Width 18" Insert 1 1/2" Watts 2700/1869 Volts 250/208</p> 

Part numbers and illustrations are intended solely for identification, Items offered for sale are not represented to be manufactured by the company that built the original equipment, actual product may vary from illustration.











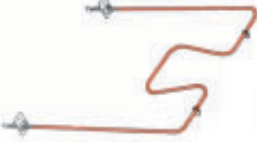



Bake & Broil Elements

<p>RP44X5099 Bake</p> <p>Replaces: GE WB44X5099 Bracket 1339 Terminal 6057 Length 15 1/2" Width 18" Insert 1 1/2" Watts 2700/1869 Volts 250/208</p> 	<p>RP45X56 Broil</p> <p>Replaces: GE WB45X56 Bracket N/A Terminal 5683 Length 14 1/2" Width 12" Insert 2" Watts 3000/2250 Volts 240/208</p> 	<p>RP4835 Broil</p> <p>Replaces: Sunray 0300-04 Bracket 2377 Terminal 2672 Length 15 3/4" Width 13 1/4" Insert 1 7/8" Watts 3000/2250 Volts 240/208</p> 	<p>RP4876 Bake</p> <p>Replaces: Kenmore 1311494 Bracket 2364 Terminal 1338 Length 17 3/8" Width 6 5/8" Insert 2 3/8" Watts 1500 Volts 208</p> 
<p>RP528 Bake</p> <p>Replaces: Whirlpool 265619 Bracket 2370 Terminal 6057 Length 16 5/8" Width 16" Insert 1" Watts 2300/1725 Volts 240/208</p> 	<p>RP571 Bake</p> <p>Replaces: GE WB44X133 Bracket 2460 Terminal plug-in Length 14" Width 19" Insert 1 1/2" Watts 3000/2250 Volts 240/208</p> 	<p>RP572 Broil</p> <p>Replaces GE WB45X58 Bracket 2460 Terminal 5683 Length 17 1/4" Width 13 1/4" Insert 2 1/2" Watts 2750/2063 Volts 240/208</p> 	<p>RP579 Broil</p> <p>Replaces: Hardwick 0E00200399 Bracket 2370 Terminal 6057 Length 16" Width 13 1/2" Insert 1 3/4" Watts 3000/2250 Volts 240/208</p> 
<p>RP580 Bake</p> <p>Replaces: Chromalox ROU-N Bracket 2378 Terminal 6057 Length 15 7/8" Width 13 5/8" Insert 1 5/8" Watts 2300/1725 Volts 240/208</p> 	<p>RP583 Broil</p> <p>Replaces: Modern Maid 7406164 Bracket 2370 Terminal 6057 Length 16" Width 13 1/4" Insert 2 1/2" Watts 3000/2250 Volts 240/208</p> 	<p>RP584 Bake</p> <p>Replaces: Admiral 73225 Bracket 2378 Terminal 6057 Length 14 3/8" Width 18 1/8" Insert 2 7/8" Watts 3100/2146 Volts 250/208</p> 	<p>RP5862 Bake</p> <p>Replaces: Hardwick 0E00105099 Bracket 2365 Terminal 6131 Length 16 1/2" Width 18 3/4" Insert 3 1/16" Watts 2800/2100 Volts 240/208</p> 
<p>RP587 Bake</p> <p>Replaces: Eagle 56991 Bracket 2378 Terminal 6057 Length 16" Width 13" Insert 3" Watts 2300/1725 Volts 240/208</p> 	<p>RP591 Broil</p> <p>Replaces: Sunray 3005 Bracket 2377 Terminal 6057 Length 17" Width 13 1/2" Insert 1 1/8" Watts 3000/2250 Volts 240/208</p> 	<p>RP595 Bake</p> <p>Replaces: Maytag 1938258 Bracket 2369 Terminal 6057 Length 16 1/4" Width 21" Insert 3" Watts 3100/2325 Volts 240/208</p> 	<p>RP613 Bake</p> <p>Replaces: Vernois P189 Bracket 2378 Terminal 6057 Length 17 5/8" Width 14 1/8" Insert 1 7/8" Watts 2300/1725 Volts 240/208</p> 













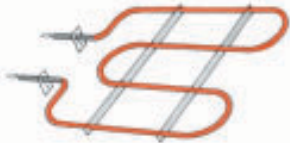

Bake & Broil Elements

<p>RP619 Broil</p> <p>Replaces: Tappan 02-233-2 Bracket 1500 Terminal 6057 Length 16 3/4" Width 11" Insert 1 3/8" Watts 2750/2063 Volts 240/208</p> 	<p>RP620 Bake</p> <p>Replaces: Sunray 3002 Bracket 2378 Terminal 6057 Length 15 3/4" Width 12 3/4" Insert 2 7/8" Watts 2100/1577 Volts 240/208</p> 	<p>RP624 Bake</p> <p>Replaces: Tappan 221T008P03 Bracket 1819 Terminal 6057 Length 15 1/2" Width 17 7/8" Insert 2" Watts 2500/1875 Volts 240/208</p> 	<p>RP625 Bake</p> <p>Replaces: Tappan 221T004P01 Bracket 2378 Terminal 6057 Length 13 3/4" Width 18 1/4" Insert 1 5/8" Watts 2400/1800 Volts 240/208</p> 
<p>RP629 Bake</p> <p>Replaces: Whirlpool 241215 Bracket 2378 Terminal 6057 Length 16 7/8" Width 19 1/4" Insert 3 1/4" Watts 2400/1800 Volts 240/208</p> 	<p>RP632 Broil</p> <p>Replaces: Philco 3204-35 Bracket 5771 Terminal 1338 Length 15 1/4" Width 13" Insert 3" Watts 1500/1125 Volts 240/208</p> 	<p>RP640 Bake</p> <p>Replaces: Whirlpool 265619 Bracket 2770 Terminal 6057 Length 17 1/8" Width 2" Insert 1" Watts 1500/1125 Volts 240/208</p> 	<p>RP641 Bake</p> <p>Replaces: Westinghouse 5300207517 Bracket 1340 Terminal 6057 Length 15 3/4" Width 19 3/4" Insert 1 3/8" Watts 3000/2250 Volts 240/208</p> 
<p>RP651 Bake</p> <p>Replaces: Westinghouse 5300210961 Bracket 2723 Terminal 6057 Length 14 3/4" Width 14" Insert 1 1/2" Watts 2400/1800 Volts 240/208</p> 	<p>RP653 Bake</p> <p>Replaces: Westinghouse Q210911 Bracket 2723 Terminal 6057 Length 13 1/2" Width 21" Insert 1 1/2" Watts 3000/2250 Volts 240/208</p> 	<p>RP660 Bake</p> <p>Replaces: Tappan/O'Keefe & Merritt 221L003P01 Bracket 2378 Terminal 6057 Length 17 9/16" Width 14 1/2" Insert 1" Watts 2200/1650 Volts 240/208</p> 	<p>RP672 Bake</p> <p>Replaces: Monarch R01-08041 Bracket 2378 Terminal 6057 Length 16 1/2" Width 16" Insert 1 1/2" Watts 2300/1725 Volts 240/208</p> 
<p>RP673 Bake</p> <p>Replaces: Philco 3204-40 Bracket 2378 Terminal 6057 Length 16 1/2" Width 19 3/4" Insert 1 1/2" Watts 3000/2250 Volts 240/208</p> 	<p>RP680 Bake</p> <p>Replaces: Brown 184-2E28 Bracket 2420 Terminal 6057 Length 13 5/8" Width 20 5/16" Insert 2 7/8" Watts 2600/1950 Volts 240/208</p> 	<p>RP6800 Bake</p> <p>Replaces: Jenn-Air 715269 Bracket 2369 Terminal 6057 Length 16 3/8" Width 12 1/4" Insert 1 3/16" Watts 2000/1500 Volts 240/208</p> 	<p>RP681 Broil</p> <p>Replaces: Brown 184-2E35 Bracket 1819 Terminal 6057 Length 16 1/4" Width 10" Insert 2" Watts 2300/1725 Volts 240/208</p> 

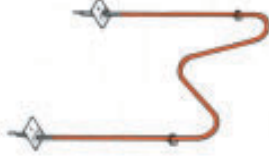









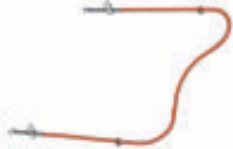





Bake & Broil Elements

<p>RP700 Bake</p> <p>Replaces: Whirlpool 832513 Bracket 2378 Terminal 6057 Length 16 1/4" Width 21 5/16" Insert 3" Watts 2500/1875 Volts 240/208</p> 	<p>RP701 Bake</p> <p>Replaces: Chambers 7568E Bracket 2378 Terminal 6057 Length 16 1/2" Width 15 3/4" Insert 1 3/4" Watts 2750/2065 Volts 240/208</p> 	<p>RP7019 Bake</p> <p>Replaces: Maytag 74003019 Bracket 2365 Terminal 2672 Length 15 1/2" Width 19 3/4" Insert 3 1/2" Watts 2800/2100 Volts 240/208</p> 	<p>RP7155 Broil</p> <p>Replaces: Whirlpool 814431 Bracket 2601 Terminal 2672 Length 15 1/2" Width 19" Insert 3" Watts 3400/2550 Volts 240/208</p> 
<p>RP716 Bake</p> <p>Replaces: Westinghouse 5300207513 Bracket 1339 Terminal 6057 Length 15 5/8" Width 18" Insert 2 1/4" Watts 3000/2250 Volts 240/208</p> 	<p>RP717 Bake</p> <p>Replaces: Kelvinator K1313171 Bracket 2378 Terminal 6057 Length 17 3/4" Width 19 1/4" Insert 3 1/8" Watts 2400/1800 Volts 240/208</p> 	<p>RP720 Broil</p> <p>Replaces: Whirlpool 293146 Bracket 2377 Terminal 6057 Length 15 1/2" Width 19 1/2" Insert 2 3/4" Watts 3000/2250 Volts 240/208</p> 	<p>RP738 Bake</p> <p>Replaces: Whirlpool 241622 Bracket 2368 Terminal 6057 Length 17 1/2" Width 9 3/4" Insert 2 3/4" Watts 2100/1454 Volts 250/208</p> 
<p>RP743 Bake</p> <p>Replaces: Chambers K16337 Bracket 2378 Terminal 1338 Length 15" Width 19 1/4" Insert 2" Volts 240/208</p> 	<p>RP746 Broil</p> <p>Replaces: Roper 300664 Bracket 2377 Terminal 6057 Length 16 1/4" Width 13 1/4" Insert 2 1/4" Volts 240/208</p> 	<p>RP748 Bake</p> <p>Replaces: Kenmore 630718 Bracket 2378 Terminal 6057 Length 16 1/2" Width 20 1/4" Insert 2 1/2" Volts 240/208</p> 	<p>RP751 Broil</p> <p>Replaces: Tappan/01-233-9 Bracket 1500 Terminal 6057 Length 16 3/8" Width 11" Insert 1 1/4" Watts 3000/2250</p> 
<p>RP761 Bake</p> <p>Replaces: Modern Maid 7406171 Bracket 2378 Terminal 2672 Length 16" Width 21 3/16" Insert 2 1/2" Watts 3000/2250 Volts 240/208</p> 	<p>RP775 Bake</p> <p>Replaces: Chambers 1312853 Bracket 2365 Terminal 6131 Length 15" Width 19 1/4" Insert 3 3/4" Watts 2400/1800 Volts 240/208</p> 	<p>RP776 Bake</p> <p>Replaces: Hardwick 0E00104899 Bracket 2378 Terminal 2672 Length 15 3/8" Width 19 5/16" Insert 3 5/8" Watts 2500/1875 Volts 240/208</p> 	<p>RP777 Bake</p> <p>Replaces: Kenmore 301444 Bracket 2858 Terminal 2672 Length 15 1/4" Width 19 3/4" Insert 3 3/4" Watts 2750/2065 Volts 240/208</p> 

Bake & Broil Elements



<p>RP778 Bake</p> <p>Bracket 2365 Terminal 6131 Length 15 5/8" Insert 2 7/8" Watts 2100/1577 Volts 240/208</p> 	<p>RP779 Broil</p> <p>Replaces: Whirlpool 660579 Bracket n/a Terminal 1993 Length 18 1/2" Width 11 3/4" Insert n/a Watts 3000/2250 Volts 240/208</p> 	<p>RP780 Bake</p> <p>Replaces: Enterprise 150617 Bracket 2378 Terminal 2672 Length 15" Width 18 3/8" Insert 3 1/8" Watts 2250/1688 Volts 240/208</p> 	<p>RP781 Bake</p> <p>Replaces: Caloric 91222 Bracket 2378 Terminal 2672 Length 15" Width 15 1/2" Insert 3 1/8" Watts 2000/1500 Volts 240/208</p> 
<p>RP789 Broil</p> <p>Replaces: Roper 314987 Bracket 2377 Terminal 2672 Length 15 3/8" Width 14 1/4" Insert 3 3/8" Watts 3400/2550 Volts 240/208</p> 	<p>RP790 Bake</p> <p>Replaces: Jenn-Air 201767 Bracket 2369 Terminal 2672 Length 15 3/4" Width 16 5/8" Insert 3 5/16" Watts 2600/1950 Volts 240/208</p> 	<p>RP792 Bake</p> <p>Replaces: Roper 4330446 Bracket 2369 Terminal 2672 Length 15 1/4" Width 19 1/4" Insert 4 1/8" Watts 2500/1875 Volts 240/208</p> 	<p>RP793 Broil</p> <p>Replaces: Roper 316186 Bracket 2378 Terminal 2672 Length 15 7/8" Width 13 1/4" Insert 4 1/8" Watts 3000/2250 Volts 240/208</p> 
<p>RP798 Bake</p> <p>Replaces: Maytag 4000041 Bracket 2369 Terminal 6131 Length 15" Width 19" Insert 3" Watts 2585/1940 Volts 240/208</p> 	<p>RP799 Bake</p> <p>Replaces: Eagle E1345-26 Bracket 2365 Terminal 2672 Length 15 5/8" Width 12 1/2" Insert 2 3/4" Watts 2600/1950 Volts 240/208</p> 	<p>RP805 Bake</p> <p>Replaces: Whirlpool 268766 Bracket 2378 Terminal 6057 Length 15 1/4" Width 21 1/2" Insert 1 1/4" Watts 2600/1950 Volts 240/208</p> 	<p>RP815 Broil</p> <p>Replaces: Caloric 96093P01 Bracket 2364 Terminal 2672 Length 16 1/2" Width 13 1/4" Insert 3 1/4" Watts 3000/2077 Volts 250/208</p> 
<p>RP825 Bake</p> <p>Replaces: Modern Maid 7406166 Bracket 2435 Terminal 6131 Length 11 7/8" Width 14 5/16" Insert 1" Watts 2000/1500 Volts 240/208</p> 	<p>RP829 Broil</p> <p>Replaces: Chambers 1311292 Bracket 2583 Terminal 2672 Length 15 1/2" Width 13 1/4" Insert 3 1/2" Watts 3400/2550 Volts 240/208</p> 	<p>RP832 Bake</p> <p>Replaces: Kenmore 37265 Bracket 2378 Terminal 6057 Length 15 3/4" Width 16" Insert 3 1/2" Watts 2000/1500 Volts 240/208</p> 	<p>RP835 Broil</p> <p>Replaces: Roper 4327217 Bracket 2377 Terminal 2672 Length 16" Width 13 1/4" Insert 3 1/8" Watts 3400/2550 Volts 240/208</p> 

Bake & Broil Elements





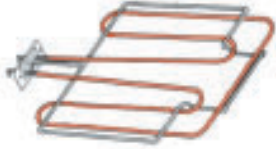



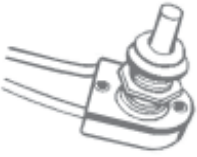

<p>RP836 Bake</p> <p>Replaces: Kenmore 82520 Bracket 2378 Terminal 2672 Length 16" Width 21 5/16" Insert 3" Watts 2500/1875 Volts 240/208</p> 	<p>RP837 Bake</p> <p>Replaces: Whirlpool 866375 Bracket 2365 Terminal 6131 Length 15 3/8" Width 19 1/4" Insert 3 3/4" Watts 2400/1800 Volts 240/208</p> 	<p>RP839 Bake</p> <p>Replaces: Chambers K14079 Bracket 2378 Terminal 2672 Length 16" Width 20 1/4" Insert 3" Watts 2600/1950 Volts 240/208</p> 	<p>RP840 Bake</p> <p>Replaces: Ropers K16337 Bracket 2378 Terminal 6057 Length 16" Width 20 1/4" Insert 1 1/2" Watts 2200/1650 Volts 240/208</p> 
<p>RP841 Bake</p> <p>Replaces: Whirlpool 326793 Bracket 2365 Terminal 6131 Length 15 5/16" Width 21 3/4" Insert 3" Watts 2500/1880 Volts 240/208</p> 	<p>RP853 Bake</p> <p>Replaces: GE WB44X5094 Bracket 2420 Terminal 2672 Length 15 3/4" Width 13 1/4" Insert 2 1/2" Watts 2000/1500 Volts 240/208</p> 	<p>RP856 Bake</p> <p>Replaces: Maytag 4000066 Bracket 2369 Terminal 3131 Length 16" Width 16" Insert 2" Watts 2750/2065 Volts 240/208</p> 	<p>RP858 Broil</p> <p>Replaces: Roper/Whirlpool 26360 Bracket 2377 Terminal 2672 Length 15 1/8" Width 13 1/4" Insert 4 1/8" Watts 3400/2550 Volts 240/208</p> 
<p>RP862 Broil</p> <p>Replaces: Roper/Whirlpool 4334925 Bracket 2377 Terminal 2672 Length 15 3/4" Width 13 1/4" Insert 4 1/8" Watts 3400/2550 Volts 240/208</p> 	<p>RP871 Bake</p> <p>Replaces: Roper/Whirlpool 4334928 Bracket 2378 Terminal 2672 Length 15 3/4" Width 13 1/4" Insert 4" Watts 3400/2550 Volts 240/208</p> 	<p>RP872 Bake</p> <p>Replaces: Amana C2704901 Bracket 2858 Terminal 2672 Length 16" Width 19 1/4" Insert 3 3/8" Watts 2500/1875 Volts 240/208</p> 	<p>RP958 Bake</p> <p>Replaces: Norge 41-5958 Bracket 2368 Terminal 2672 Length 15 1/2" Width 18 3/4" Insert 3" Watts 3000/2250 Volts 240/208</p> 
<p>RP969 Bake</p> <p>Replaces: Frigidaire 9950891 Bracket 1543 Terminal 5282 Length 18 3/8" Width 13 1/4" Insert 2 3/4" Watts 2700/1869 Volts 250/208</p> 	<p>RP978 Bake</p> <p>Replaces: Frigidaire 8004202 Bracket 1340 Terminal 2672 Length 14 5/8" Width 19 1/4" Insert 1 3/8" Watts 3000/2330 Volts 236/208</p> 	<p>RP979 Bake</p> <p>Replaces: Frigidaire 5309950887 Bracket 1340 Terminal 2672 Length 17 3/8" Width 13 1/4" Insert 1 3/8" Watts 3000/2330 Volts 236/208</p> 	<p>RP980 Bake</p> <p>Replaces: GE WB44X5019 Bracket 2461 Terminal 5683 Length 15" Width 15 1/2" Insert 1 1/2" Watts 3000/2250 Volts 240/208</p> 

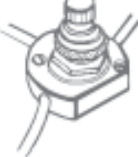
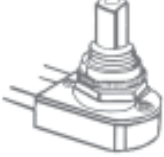
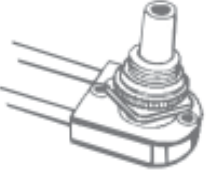
Bake & Broil Elements

RP985	Broil	RP987	Broil
Replaces:	GE WB44X5045	Replaces:	Whirlpool 326795
Terminal	1338	Terminal	1993
Length	16 7/8"	Length	18 3/4"
Width	13 1/4"	Width	11 1/2"
Insert	1 3/4"	Insert	---
Watts	3000/2250	Watts	3000/2250
Volts	240/208	Volts	240/208

Range Accessories

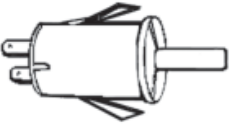
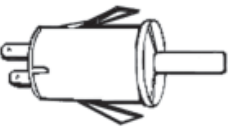
ES15100 Canopy Switch	ES15102 Canopy Switch	ES15105 Two Speed Fan	ES15106 Canopy Switch	ES15108 Single Speed Rotary
Metal Push Button On - Off Longer Threaded Shaft	Phenolic Push Button Off - On - On	Metal Rotary Button On - Off - On	Metal Push Button On - Off Shorter Threaded Shaft	Metal Rotary Button On - Off
Replaces: 15100, 151	Replaces: 15102, 151-2	Replaces: 15105, 151-5	Replaces: 15106, 151-6	Replaces: 15108, 151-8
Amps 3 / 1 amps	Amps 3 / 1 amps	Amps 3 / 1 amps	Amps 3 / 1 amps	Amps 3 / 1 amps
Volts 125 / 250	Volts 125 / 250	Volts 125 / 250	Volts 125 / 250	Volts 125 / 250
Mount Threaded	Mount Threaded	Mount Threaded	Mount Threaded	Mount Threaded
				
ES15200 Pilot Light	ES15201 Pilot Light	ES15202 Pilot Light	ES15204 Pilot Light	ES15205 Pilot Light
Raised Red Lens	Flush Red Lens	Flush Red Lens	5/16" Dia. Flush Red Lens	Special for GE
Replaces: 15200, 152, 7006	Replaces: 15201, 152-1, 4157976, 4157870	Replaces: 15202, 152-2, 0088640, 0088777	Replaces: 15204, 152-4, 04000016, 7407P062-60	Replaces: 15205, 152-5, WB2X1608
Watts 1/3	Watts 1/3	Watts 1/3	Watts 1/3	Watts 1/3
Volts 125	Volts 125	Volts 250	Volts 125	Volts 125
Mount Snap in	Mount Snap in	Mount Snap in	Mount Snap in	Mount Snap in
				
ES15211 Pilot Light	ES15400 Oven Door Switch	ES15401 Oven Door Switch	ES15402 Oven Door Switch	ES15501 Pilot Light
Flush Red Lens for pilot lights	3/4" High Temperature momentary On Normally Open	3/4" High Temperature momentary On Normally Open	3/4" High Temperature momentary On Normally Open	Rectangular Red Lens
Replaces: 15211, 152-11	Replaces: 15400, 154, WB24K2, WB24X795, 347305	Replaces: 15401, 154-1, 310345, 3196261	Replaces: 15402, 154-2, 3196262	Replaces: 15501, 155-1
Watts 1/3	Amps 3 / 1 amps	Amps 10 / 7.5 amps	Amps 10 / 7.5 amps	Watts 1/3
Volts 125	Volts 125 / 250	Volts 125 / 250	Volts 125 / 250	Volts 125
Mount Push-in	Mount Snap in	Mount Snap in	Mount Snap in	Mount Snap in
Use with ES15205 to replace Maytag 715396K				

Range & Appliance Wire

Sil-A-Blend®

Sil-A-Blend is the same high temperature wire that you have been using,

1. With a plated copper conductor
2. Silicone high temperature insulation
3. Glass braided cover for abrasion resistance

Here is the new twist.

4. A coat of colored silicone over the top of the glass braid
5. Triplexed in Red / White / Black for easy application

- No more itching
- Easier to strip,
- Replaces plastic, rubber and glass braid wire (up to 200°C / 392°F)
- Colors won't fade
- **UL / CSA**



Triplex 3 conductor twisted (Red / Black / White) rated to 392°F / 200°C

Gauge	Length	Packed	Sil-A-Blend® Silicone over Glass Braid	Old Style Glass Braid	Max amps at 40°C	Max Wattage at 40°C 240V / 120V
14	5 Feet	Bag	RP0514G	RP0514GB	36	8 / 4 KW
12	5 Feet	Bag	RP0512G	RP0512GB	45	10 / 5 KW
14	25 Feet	Boxed	RP2514G	RP2514GB	36	8 / 4 KW
12	25 Feet	Boxed	RP2512G	RP2512GB	45	10 / 5 KW
14	50 Feet	Boxed	RP5014G	RP5014GB	36	8 / 4 KW
12	50 Feet	Boxed	RP5012G	RP5012GB	45	10 / 5 KW

Go to www.supco.com for ampacity ratings at higher temperatures.

Old Style Glass Braid is the same high temperature wire that you have been using,

1. With a plated copper conductor
2. Silicone high temperature insulation
3. Glass braided cover for abrasion resistance

Replaces plastic, rubber and glass braid wire (up to 200°C / 392°F)

UL / CSA

Duplex 2 conductor twisted (Red / Black) rated to 392°F / 200°C

Gauge	Length	Packed	Old Style Glass Braid	Max amps at 40°C	Max Wattage at 40°C 240V / 120V
14	50 Feet	Boxed	RP21425GB	36	8 / 4 KW
14	25 Feet	Boxed	RP21225GB	36	8 / 4 KW
12	25 Feet	Boxed	RP21450GB	45	10 / 5 KW
12	50 Feet	Boxed	RP21250GB	45	10 / 5 KW

Go to www.supco.com for ampacity ratings at higher temperatures.

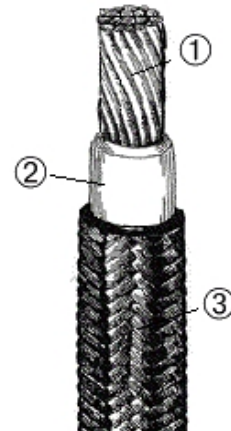

Range & Appliance Wire

250°C Nickel Hinge Wire

1. With a nickel plated copper conductor
2. Silicone high temperature insulation
3. Glass braided cover for abrasion resistance

UL / CSA

High Temperature Wire

Single conductor (neutral color - tan) 250°C Nickel Hinge wire

Gauge	Length	Packed	Glass Braid	Max amps at 40°C	Max Wattage at 40°C 240V / 120V	Temperature Rating °F / °C
18	25 feet	Bag	T301825	20	4 / 2 KW	482°F / 250°C
16	25 feet	Bag	T301625	26	6 / 3 KW	482°F / 250°C
14	25 feet	Bag	T301425	39	9 / 4.5 KW	482°F / 250°C
12	25 feet	Bag	T301225	54	12 / 6 KW	482°F / 250°C
10	25 feet	Bag	T301025	73	17 / 8.5 KW	482°F / 250°C

Go to www.supco.com for ampacity ratings at higher temperatures.

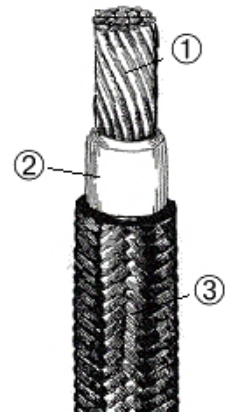

450°C Nickel Hinge Wire - MGT - Mica

1. With a nickel plated copper conductor
2. Mica high temperature insulation
3. Glass braided cover for abrasion resistance

UL / CSA

Single conductor (neutral color - tan) 450°C Nickel Hinge wire

Gauge	Length	Packed	Glass Braid	Max amps at 40°C	Max Wattage at 40°C 240V / 120V	Temperature Rating °F / °C
14	5 feet	Bag	RP0514NG	45	10 / 5 KW	842°F / 450°C
14	25 feet	Bag	RP2514NG	45	10 / 5 KW	842°F / 450°C
12	5 feet	Bag	RP0512NG	56	13 / 6.5 KW	842°F / 450°C
12	25 feet	Bag	RP2512NG	56	13 / 6.5 KW	842°F / 450°C

Go to www.supco.com for ampacity ratings at higher temperatures.

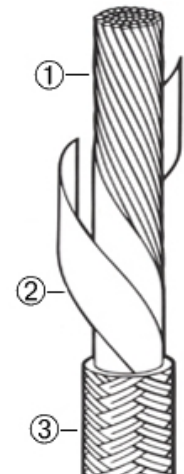

250°C High Voltage for spark ignition systems

1. Nickel plated copper conductor
2. High voltage silicone rubber insulator

UL / CSA

Single Conductor Red Silicone Rubber High Voltage Wire

Gaug	Length	Packed	Siicone Rubber	Max AC	Max DC	Temperature Rating °F / °C
16	25 feet	Bag	RP2516H	10 KVAC	25 KVDC	482°F / 250°C



Oven Door Gaskets & Racks

Oven Door Gaskets

- High Temperature Silicon Rubber
- FDA Approved Material
- Exact OEM Replacements

SUPCO No.	Description	OAL Length	C to C	Style
DG910	Stretch Gasket	8 13/16"	8 13/16"	A
DG1012	Stretch Gasket	9 13/16"	9 13/16"	A
DG1214	Stretch Gasket	11 13/16"	11 13/16"	A
DG1416	Stretch Gasket	13 13/16"	13 13/16"	A
DG1618	Stretch Gasket	15 13/16"	15 13/16"	A
DG1820	Stretch Gasket	17 13/16"	17 13/16"	A
DG2022	Stretch Gasket	19 13/16"	19 13/16"	A
DG2224	Stretch Gasket	21 13/16"	21 13/16"	A
DG2427	Stretch Gasket	24 13/16"	24 13/16"	A

SUPCO Number	Description	OAL Length Approx:	C to C	Style
DGL1012	Stretch Gasket	10 3/8"	9 13/16"	B
DGL1214	Stretch Gasket	12 3/8"	11 13/16"	B
DGL1416	Stretch Gasket	14 3/8"	13 13/16"	B
DGL1618	Stretch Gasket	16 3/8"	15 13/16"	B
DGL1820	Stretch Gasket	18 3/8"	17 13/16"	B
DGL2022	Stretch Gasket	20 3/8"	19 13/16"	B
DGL2224	Stretch Gasket	22 3/8"	21 13/16"	B
DGL2427	Stretch Gasket	24 3/8"	23 13/16"	B

SUPCO Part No.	OEM Part No.	Description	OAL Length Approx:	No. of Clips	Style
DG40	Maytag	7212-P001-60	72"	None	E
DG41	Frigidaire	647T086P02	51"	12	C
DG42	GE	WB32K3	54"	16	D
DG43	Maytag	7212-P043-60	53"	12	D
DG44	Frigidaire	316109700	32"	None	D
DG72	Universal	Extruded Gasket	72"	None	F
DG5103	GE	WB2X5103	44"	None	F



Style "A"

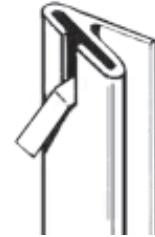

Style "B"



Style "C"



Style "D"

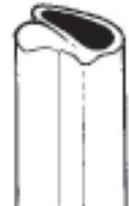

Style "E"



Style "F"

Oven Door Spring

Supco Part No.	OEM Part No.	Description	OEM	Replaces	Pack
1790263	RS101	5 3/4" OAL	Magic Chef/Maytag	1790-263, 1790-261, 1790-241, 1790-253, 1790-265, 1790-244, 7803P001-60	1



Direct and Universal Oven Racks

- Manufactured from heavy duty steel rods with a welded frame construction.
- These nickel plated racks are an affordable solution for replacing old racks.
- Heat tested to 1200°F to insure the highest quality plating.
- Replaces Regular, Self-Cleaning Gas or Electric.
- Replacement part numbers by brand or measurements for universal applications.
- Replaces many Amana, Maytag, Frigidaire, GE, Welbilt, and Whirlpool racks.



GEM P/N	Replacement For	Width	Depth	Support
OR100	General Electric WB48X5044, WB48X42, WB48X109	23"	15"	Keepers on either side
OR101	Whirlpool 3185641, 3185440, 308173	21 7/8"	16"	Keepers on either side
OR102	General Electric WB48X5012 WB48X5026 WB48X5031	23"	17"	Raised hump at back on either side

Oven Igniters

SGR Series Flat Igniters

The SIC style igniter is a direct replacement for hundreds of OEM numbers.

- Longer Life and greater strength, with the longest MTBF in the industry
- Supplied by an OEM manufacturer, meets or exceeds OEM specifications, UL & CSA.
- Will not overdrive the gas valve like some universal replacements.
- Used with 3.2 to 3.5 amp rated gas safety valves.
- 100% electrical testing, five times throughout the production process.
- High temperature stainless steel shield
- High temperature MGT wire leads
- High temperature ceramic wire nuts to wire into original harness



SGR407

Supco No.	Gem No.	Length	Supco Kit
SGR407	GR407	7 1/2"	SGR414
SGR408	GR408	9"
SGR409	GR409	5 1/2"	SGR414
SGR410	GR410	6 1/4"	SGR414
SGR411	GR411	6 1/4"	SGR414
SGR412	GR412	4 1/2"	SGR414



SGR414

SGR414 Universal Flat Igniter Kit

SGR414 universal flat igniter kit was designed to replace most flat range igniter with a shield mount. Hardware included will allow one flat igniter to replace hundreds. The SGR414 replaces the SGR407, SGR409, SGR410, SGR411, and SGR412.

SGR415 Direct Replacement Igniter

SGR415 is a direct replacement for the General Electric WB2X10016. No cutting or splicing required.



SGR415

SGR Series Round Igniters

- The SIC style igniter is a direct replacement for hundreds of OEM numbers.
- Longer Life and greater strength, with the longest MTBF in the industry
- Supplied by an OEM manufacturer, meets or exceeds OEM specifications, UL & CSA.
- Will not overdrive the gas valve like some universal replacements.
- Used with 2.8 to 3.0 amp rated gas safety valves.
- 100% electrical testing, five times throughout the production process.
- High temperature stainless steel shield
- High temperature MGT wire leads
- High temperature ceramic wire nuts to wire into original harness

Supco No.	Gem No.	Length	Supco Kit
SGR401	GR401	6 1/4"	SGR400
SGR402	GR402	5 1/4"	SGR400
SGR403	GR403	3 1/2"	SGR400
SGR404	GR404	3 1/2"	SGR400
SGR405	GR405	3 1/2"	SGR400

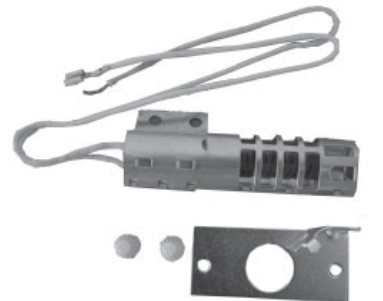

SGR403

SGR400 Universal Round Igniters

SGR400 universal round igniter kit was designed to replace most round range igniter with a shield mount. Hardware included will allow one round igniter to replace hundreds. The SGR400 replaces SGR401, SGR402, SGR403, SGR404, SGR405.



SGR400

OEM Cross Reference For Range Igniters

Baker's Pride			Electrolux (Cont.)			Electrolux (Cont.)			General Electric		
OEM No.	Supco No.	Supco Kit	OEM No.	Supco No.	Supco Kit	OEM No.	Supco No.	Supco Kit	OEM No.	Supco No.	Supco Kit
M2041A	SGR412	SGR414	316T017P03	SGR403	SGR400	A1505786	SGR403	SGR400	223C3381G005	SGR412	SGR414
Blodgett			316T017P05	SGR403	SGR400	AP00205001	SGR412	SGR414	GM142027	SGR403	SGR400
OEM No.	Supco No.	Supco Kit	316T017P06	SGR403	SGR400	AP00205005	SGR412	SGR414	WB13K1	SGR403	SGR400
11511	SGR403	SGR400	316T017P07	SGR403	SGR400	AP00205006	SGR412	SGR414	WB13K3	SGR403	SGR400
17952	SGR403	SGR400	316T017S01	SGR403	SGR400	AP00205011	SGR412	SGR414	WB13K4	SGR403	SGR400
Brown Stove			316T023P01	SGR409	SGR414	AP00205013	SGR412	SGR414	WB13K12	SGR412	SGR414
OEM No.	Supco No.	Supco Kit	316T023P02	SGR409	SGR414	AP00205014	SGR409	SGR414	WB13K13	SGR412	SGR414
180-2A190	SGR412	SGR414	316T023P03	SGR407	SGR414	AP00205015	SGR412	SGR414	WB13K14	SGR412	SGR414
180-2A216	SGR410	SGR414	316T023P04	SGR409	SGR414	AP00235030	SGR403	SGR400	WB13K21	SGR412	SGR414
180-2A251	SGR411	SGR414	316T023P05	SGR409	SGR414	AP205001	SGR412	SGR414	WB22X105	SGR402	SGR400
180-2A300	SGR412	SGR414	316T023P06	SGR409	SGR414	AP205002	SGR412	SGR414	WB2X4221	SGR409	SGR414
180-2A303	SGR412	SGR414	316T023P07	SGR407	SGR414	AP205004	SGR412	SGR414	WB2X4306	SGR409	SGR414
Crown			316T023P08	SGR409	SGR414	AP205005	SGR412	SGR414	WB2X4309	SGR409	SGR414
OEM No.	Supco No.	Supco Kit	316T023P10	SGR407	SGR414	AP205006	SGR412	SGR414	WB2X4385	SGR410	SGR414
519160	SGR401	SGR400	316T023P12	SGR407	SGR414	AP205011	SGR412	SGR414	WB2X4528	SGR412	SGR414
Dynamic Cooking			316T023S01	SGR407	SGR414	AP205013	SGR412	SGR414	WB2X4600	SGR412	SGR414
OEM No.	Supco No.	Supco Kit	316T030P01	SGR403	SGR400	AP205014	SGR409	SGR414	WB2X4752	SGR409	SGR414
16009	SGR412	SGR414	316T031P01	SGR412	SGR414	AP205015	SGR412	SGR414	WB2X4827	SGR407	SGR414
Baker's Pride			316T031P02	SGR412	SGR414	AP205016	SGR412	SGR414	WB2X5195	SGR403	SGR400
OEM No.	Supco No.	Supco Kit	316T031P03	SGR412	SGR414	AP235027	SGR403	SGR400	WB2X7954	SGR407	SGR414
7954	SGR403	SGR400	355T429S01	SGR403	SGR400	AP235030	SGR403	SGR400	WB2X8212	SGR412	SGR414
7959	SGR412	SGR414	355T429S02	SGR403	SGR400	K1301037	SGR401	SGR400	WB2X8215	SGR412	SGR414
7960	SGR412	SGR414	355T429S03	SGR403	SGR400	K1321037	SGR401	SGR400	WB2X9154	SGR403	SGR400
7964	SGR412	SGR414	5300007959	SGR412	SGR414	K1321263	SGR401	SGR400	WB2X9697	SGR412	SGR414
9190	SGR412	SGR414	5300009190	SGR412	SGR414	N316T030P01	SGR403	SGR400	WB2X9998	SGR412	SGR414
9360	SGR403	SGR400	5301321263	SGR401	SGR400	NR018	SGR412	SGR414	WB00X6609	SGR409	SGR414
9452	SGR412	SGR414	5301321263	SGR401	SGR400	NR020	SGR412	SGR414	WB02X4221	SGR409	SGR414
9590	SGR412	SGR414	5303016211	SGR409	SGR414	NR023	SGR412	SGR414	WB02X4306	SGR409	SGR414
10064	SGR412	SGR414	5303131300	SGR411	SGR414	P205001	SGR412	SGR414	WB02X4309	SGR409	SGR414
10220	SGR409	SGR414	5303200508	SGR409	SGR414	P205005	SGR412	SGR414	WB02X4385	SGR410	SGR414
10222	SGR411	SGR414	5303200508	SGR410	SGR414	P205006	SGR412	SGR414	WB02X4528	SGR412	SGR414
10233	SGR412	SGR414	5303207520	SGR412	SGR414	P205013	SGR412	SGR414	WB02X4600	SGR412	SGR414
10872	SGR409	SGR414	5303207521	SGR412	SGR414	P205014	SGR409	SGR414	WB02X4752	SGR409	SGR414
235030	SGR403	SGR400	5303210788	SGR412	SGR414	P205015	SGR412	SGR414	WB02X4827	SGR407	SGR414
3016211	SGR409	SGR414	5303308452	SGR412	SGR414	P205016	SGR412	SGR414	WB2X10016	SGR412	SGR414
3018981	SGR412	SGR414	5303308468	SGR412	SGR414	P205023	SGR409	SGR414	WB02X10016	SGR415	SGR414
3131090	SGR412	SGR414	5303912567	SGR407	SGR414	P205034	SGR412	SGR414	WB13T10001	SGR412	SGR414
3131300	SGR412	SGR414	5303912586	SGR403	SGR400	P205035	SGR409	SGR414	Harper Wyman		
3131872	SGR409	SGR414	5303912586	SGR401	SGR400	P205036	SGR412	SGR414	OEM No.	Supco No.	Supco Kit
3200508	SGR410	SGR414	5303935066	SGR412	SGR414	P235030	SGR403	SGR400	54099H02	SGR409	SGR414
3203706	SGR412	SGR414	5303935066	SGR412	SGR414	Q000198333	SGR403	SGR400	54099H03	SGR410	SGR414
3204718	SGR412	SGR414	5303935067	SGR409	SGR414	Q000198338	SGR412	SGR414	54099H04	SGR411	SGR414
3205156	SGR412	SGR414	5303935067	SGR409	SGR414	Q000198339	SGR412	SGR414	54099H05	SGR412	SGR414
8007988	SGR403	SGR400	5303935068	SGR407	SGR414	Q000198344	SGR412	SGR414	54099H06	SGR408	
08007988	SGR403	SGR400	5303935068	SGR407	SGR414	FMP			54099H07	SGR407	SGR414
08009420	SGR412	SGR414	5304401265	SGR403	SGR400	OEM No.	Supco No.	Supco Kit	Jade Range		
08011454	SGR409	SGR414	5304401265	SGR403	SGR400	187-1076	SGR403	SGR400	OEM No.	Supco No.	Supco Kit
08011455	SGR412	SGR414	5308007988	SGR403	SGR400	220-1191	SGR412	SGR414	501A	SGR412	SGR414
08013883	SGR412	SGR414	5308009420	SGR412	SGR414	Garland Range			Market Forge		
08067970	SGR407	SGR414	5308011452	SGR412	SGR414	OEM No.	Supco No.	Supco Kit	OEM No.	Supco No.	Supco Kit
08067971	SGR412	SGR414	5308011453	SGR412	SGR414	501A	SGR412	SGR414	10-8259	SGR403	SGR400
08068021	SGR409	SGR414	5308011454	SGR412	SGR414	General Electric			Maytag		
316030600	SGR412	SGR414	5308011454	SGR409	SGR414	OEM No.	Supco No.	Supco Kit	OEM No.	Supco No.	Supco Kit
316030700	SGR409	SGR414	5308011455	SGR412	SGR414	300259	SGR403	SGR400	0042166	SGR402	SGR400
316119301	SGR412	SGR414	5308067970	SGR407	SGR414	319887	SGR403	SGR400	0047067	SGR402	SGR400
316119302	SGR409	SGR414	5312400035	SGR412	SGR414	327617	SGR403	SGR400	0054068	SGR405	SGR400
316126400	SGR412	SGR414	223240-1010	SGR412	SGR414	330689	SGR403	SGR400	0061567	SGR405	SGR400
318177710	SGR412	SGR414	A00P235030	SGR403	SGR400	336650	SGR407	SGR414	0061568	SGR405	SGR400
318177710	SGR412	SGR414	A1505507	SGR412	SGR414	337263	SGR403	SGR400	0062766	SGR408	
318177720	SGR412	SGR414	A1505508	SGR412	SGR414	4336387	SGR403	SGR400	0063148	SGR408	
318177720	SGR412	SGR414	A1505523	SGR403	SGR400	4337848	SGR412	SGR414	0064395	SGR408	
318177730	SGR412	SGR414	A1505744	SGR412	SGR414	4338008	SGR403	SGR400	0064446	SGR408	
318177730	SGR412	SGR414	A1505745	SGR412	SGR414	4342528	SGR403	SGR400	0064671	SGR408	
072T699F01	SGR403	SGR400	A1505748	SGR412	SGR414	223C3381G001	SGR412	SGR414	0068013	SGR405	SGR400
316T013S01	SGR403	SGR400	A1505782	SGR412	SGR414	223C3381G002	SGR412	SGR414	0068014	SGR405	SGR400
316T017P01	SGR403	SGR400	A1505783	SGR412	SGR414	223C3381G003	SGR412	SGR414	0068015	SGR405	SGR400
316T017P02	SGR403	SGR400	A1505784	SGR412	SGR414	223C3381G004	SGR412	SGR414	0068016	SGR405	SGR400

OEM Cross Reference For Range Igniters

Maytag (Cont.)			Maytag (Cont.)			Maytag (Cont.)			Whirlpool (Cont.)		
Supco No.	Supco Kit	OEM No.	Supco No.	Supco Kit	OEM No.	Supco No.	Supco Kit	OEM No.	Supco No.	Supco Kit	
0068017	SGR405	SGR400	74007399	SGR412	SGR414	31-0311618-04-0	SGR408	327617	SGR403	SGR400	
0068018	SGR405	SGR400	74007498	SGR412	SGR414	R0710104	SGR408	330689	SGR403	SGR400	
0068019	SGR405	SGR400	74008064	SGR412	SGR414	R0710131	SGR408	336650	SGR407	SGR414	
0068025	SGR408		74-06-170	SGR402	SGR400	R0710132	SGR408	337263	SGR403	SGR400	
0068026	SGR408		74-06-199	SGR402	SGR400	R0710221	SGR408	439202	SGR409	SGR414	
0068043	SGR408		74-06-219	SGR402	SGR400	Norton / Eaton			786324	SGR408	
0069737	SGR405	SGR400	0100500399	SGR402	SGR400	OEM No.	Supco No.	Supco Kit	786924	SGR408	
0070245	SGR405	SGR400	0100504199	SGR411	SGR414	IGN-1	SGR407	SGR414	814269	SGR412	SGR414
0070369	SGR405	SGR400	0100505099	SGR411	SGR414	IGN-2	SGR409	SGR414	814284	SGR401	SGR400
0070957	SGR405	SGR400	7432M075-60	SGR412	SGR414	IGN-3	SGR410	SGR414	814289	SGR403	SGR400
0072202	SGR405	SGR400	7432P025-60	SGR412	SGR414	IGN-4	SGR411	SGR414	816624	SGR409	SGR414
0072203	SGR405	SGR400	7432P026-60	SGR412	SGR414	IGN-5	SGR412	SGR414	816625	SGR412	SGR414
0086689	SGR405	SGR400	7432P032-60	SGR411	SGR414	IGN-6	SGR408		816826	SGR412	SGR414
0086690	SGR405	SGR400	7432P033-60	SGR412	SGR414	IGN-7	SGR407	SGR414	816928	SGR403	SGR400
0087699	SGR408		7432P035-60	SGR412	SGR414	IGN-8	SGR412	SGR414	3186491	SGR412	SGR414
0089333	SGR405	SGR400	7432P036-60	SGR411	SGR414	Peerless			3196447	SGR403	SGR400
0091160	SGR405	SGR400	7432P040-60	SGR412	SGR414	OEM No.	Supco No.	Supco Kit	4157446	SGR403	SGR400
0309145	SGR408		7432P051-60	SGR412	SGR414	1469	SGR404	SGR400	4157689	SGR401	SGR400
0309150	SGR405	SGR400	7432P052-60	SGR412	SGR414	Robertshaw			4163781	SGR407	SGR414
0309151	SGR405	SGR400	7432P062-60	SGR412	SGR414	OEM No.	Supco No.	Supco Kit	4164936	SGR401	SGR400
0309154	SGR405	SGR400	7432P064-60	SGR412	SGR414	41-202	SGR409	SGR414	4165441	SGR401	SGR400
0309155	SGR403	SGR400	7432P066-60	SGR412	SGR414	41-203	SGR410	SGR414	4168768	SGR401	SGR400
0309157	SGR408		7432P067-60	SGR412	SGR414	41-204	SGR411	SGR414	4170062	SGR401	SGR400
0309157SV	SGR408		7432P075-60	SGR412	SGR414	41-205	SGR412	SGR414	4320913	SGR412	SGR414
0309158	SGR408		7432P076-60	SGR412	SGR414	41-206	SGR408		4322910	SGR403	SGR400
0309158SV	SGR408		7432P106-60	SGR412	SGR414	41-207	SGR407	SGR414	4328133	SGR403	SGR400
0309159	SGR408		7432P025-60K	SGR412	SGR414	Surface Igniter			4331193	SGR403	SGR400
10-9220	SGR402	SGR400	7432P051-60K	SGR409	SGR414	OEM No.	Supco No.	Supco Kit	4331669	SGR403	SGR400
1482224	SGR412	SGR414	7432P052-60K	SGR412	SGR414	NR001	SGR408		4332948	SGR403	SGR400
1482225	SGR412	SGR414	33-42166-04-0	SGR402	SGR400	NR002	SGR410	SGR414	4333355	SGR403	SGR400
309157	SGR408		33-61567-04-0	SGR405	SGR400	NR004	SGR409	SGR414	4333356	SGR403	SGR400
309158	SGR408		33-61568-04-0	SGR405	SGR400	NR005	SGR411	SGR414	4335338	SGR403	SGR400
359-176	SGR402	SGR400	33-62766-04-0	SGR408		NR006	SGR407	SGR414	4336387	SGR403	SGR400
359-181	SGR402	SGR400	33-63148-04-0	SGR408		NR018	SGR412	SGR414	4337848	SGR412	SGR414
359-183	SGR412	SGR414	33-64395-04-0	SGR408		NR020	SGR412	SGR414	4338008	SGR403	SGR400
359-184	SGR412	SGR414	33-64446-04-0	SGR408		NR023	SGR412	SGR414	4338036	SGR403	SGR400
359-195	SGR412	SGR414	33-64671-04-0	SGR408		NR029	SGR412	SGR414	4342525	SGR403	SGR400
359-196	SGR412	SGR414	33-68013-04-0	SGR405	SGR400	RA262	SGR402	SGR400	4342528	SGR403	SGR400
359-199	SGR411	SGR414	33-68014-04-0	SGR405	SGR400	RA264	SGR402	SGR400	4342528	SGR403	SGR400
359-201	SGR402	SGR400	33-68015-04-0	SGR405	SGR400	RA270	SGR401	SGR400	4349502	SGR403	SGR400
359-202	SGR402	SGR400	33-68016-04-0		SGR400	RA271	SGR402	SGR400	4363351	SGR412	SGR414
359-218	SGR402	SGR400	33-68017-04-0	SGR405	SGR400	RA272	SGR403	SGR400	4363761	SGR403	SGR400
359-233	SGR412	SGR414	33-68018-04-0	SGR405	SGR400	RA273	SGR404	SGR400	4371216	SGR410	SGR414
359-234	SGR412	SGR414	33-68019-04-0	SGR405	SGR400	RC026	SGR405	SGR400	4372474	SGR412	SGR414
359-244	SGR402	SGR400	33-68025-04-0	SGR408		Thermador			4372534	SGR412	SGR414
359-247	SGR411	SGR414	33-68026-04-0	SGR408		OEM No.	Supco No.	Supco Kit	4372535	SGR412	SGR414
359-262	SGR412	SGR414	33-68043-04-0	SGR408		08-04-051	SGR412	SGR414	4389493	SGR403	SGR400
359-263	SGR412	SGR414	33-69737-04-0	SGR405	SGR400	15-10-136	SGR412	SGR414	4392018	SGR408	
359-264	SGR402	SGR400	33-70245-04-0	SGR405	SGR400	15-10-312	SGR412	SGR414	4392019	SGR407	SGR414
550346	SGR411	SGR414	33-70369-04-0	SGR405	SGR400	15-10-312-01	SGR412	SGR414	4392020	SGR409	SGR414
550735	SGR412	SGR414	33-70957-04-0	SGR405	SGR400	20-01-500	SGR412	SGR414	4392021	SGR411	SGR414
551003	SGR412	SGR414	33-72202-04-0	SGR405	SGR400	Viking			4392022	SGR407	SGR414
551207	SGR412	SGR414	33-72203-04-0	SGR405	SGR400	OEM No.	Supco No.	Supco Kit	4392023	SGR412	SGR414
551291	SGR412	SGR414	33-86689-04-0	SGR405	SGR400	PB040001	SGR412	SGR414	8053999	SGR403	SGR400
790023	SGR412	SGR414	33-86690-04-0		SGR400	Whirlpool			8169928	SGR412	SGR414
790401	SGR412	SGR414	33-87699-04-0	SGR408		OEM No.	Supco No.	Supco Kit	8184969	SGR403	SGR400
86689	SGR405	SGR400	33-89333-04-0	SGR405	SGR400	7954	SGR403	SGR400	8190012	SGR412	SGR414
86690	SGR405	SGR400	33-91160-04-0	SGR405	SGR400	9360	SGR403	SGR400	9751123	SGR409	SGR414
87699	SGR408		31-0309145-04-0	SGR408		9502	SGR403	SGR400	9751784	SGR407	SGR414
12400035	SGR412	SGR414	31-0309146-04-0	SGR408		10220	SGR409	SGR414	9753108	SGR412	SGR414
309157SV	SGR408		31-0309150-04-0	SGR405	SGR400	10222	SGR411	SGR414	9782065	SGR412	SGR414
309158SV	SGR408		31-0309151-04-0		SGR400	300259	SGR403	SGR400	98005652	SGR412	SGR414
31939801	SGR408		31-0309157-04-0	SGR408		311618	SGR409	SGR414	18601	SGR412	SGR414
31939901	SGR408		31-0309157-SV-0	SGR408		313584	SGR403	SGR400	72306D	SGR412	SGR414
31991701	SGR412	SGR414	31-0309158-04-0	SGR408		319887	SGR403	SGR400	<i>These igniters are used in many applications. Check the safety valve for voltage requirements before use.</i>		
70001036	SGR412	SGR414	31-0309158-SV-0	SGR408		321342	SGR403	SGR400			
74007398	SGR412	SGR414	31-0309159-04-0	SGR408		327263	SGR403	SGR400			

Infinite Switches

Infinite Switches

Supco infinite switch kits have a 1/8" square shaft with universal mounting kit and universal knob adapter kit. The break off shaft, universal mounting, combined with knob adapters, make these kits a must for truck stock. Using the knob adapter kit allows the "Off" position to be at the 12, 3, 6, or 9 o'clock position. All switches rotate 360°, the rotation is the direction the shaft is turned to reach high. See chart for knob kit options. All switches have P/N, Rotation, type, printed on the base.

Standard Infinite Kits

Switches are indexed at Low, Off, and High. On high the switch has continuous 100% on time, on low 5% on time. Switches can be used on large or small surface element.

Supco No.	Uni-Line No.	Operating Voltage	Maximum Load	Knob Kit	Rotation
ES5500202	5500-202	240 V	15 amps	None	CW to High
ES5500203	5500-203	240 V	15 amps	Black	CW to High
ES5500204	5500-204	240 V	15 amps	White	CW to High
ES5500225	5500-225	240 V	15 amps	None	CCW to High



ES5500202 & ES5500225



ES5500203



ES5500204

Push to Turn Kits

Push to turn kits indexed Low and High positions with locking safety feature at Off. Switch shaft must be pushed in to unlock the switch before rotation. On high the switch has continuous 100% on time, on low 5% on time. Switches can be used on large or small surface element.

Supco No.	Uni-Line No.	Operating Voltage	Maximum Load	Knob Kit	Rotation
ES5500200	5500-200	240 V	15 amps	None	CW to High
ES5500206	5500-206	240 V	15 amps	Black	CW to High
ES5500207	5500-207	240 V	15 amps	White	CW to High
ES5500299	5500-299	240 V	15 amps	None	CCW to High



ES5500200 & ES5500299



ES5500206



ES5500207

Range Knobs

Direct Replacement Knobs

Brand	Replaces OEM No.	Exact Supco No.	Color	Number of Knobs	Stem Type	Style
GE	WB3X5699	RK699	Black	3	Split	Vertical
Whirlpool	307458	RK458	Black	1	Fig. 8	Clip Left*
Whirlpool	330190	RK190	Black	1	Fig. 8	Clip Left*

*Looking at shaft side



RK699



RK458



RK190



RK362

Direct Replacement Knob Kit

Brand	Replaces OEM No.	Exact Supco No.	Color	Number of Knobs	Stem Type	Style
Whirlpool	814362	RK362	Black	9	See Chart	

Like the 814362, Supco's RK362 knob kit replaces hundreds of different knobs. The original knob kit contained the 9 knobs listed below, RK362 has all of the listed knobs. Supco does not offer these knobs individually.

Quantity	OEM No.	Description	Shaft
4	3149983	Surface Knob	Fig. 8 Clip Right*
1	3149984	Bake - Off - Broil	"D" Flat @ Broil
1	3149985	Bake - Off - Broil - Timed Broil	"D" Flat @ Broil
1	3149986	Bake - Off - Broil - Timed Broil - Clean	"D" Flat @ Broil
1	3149987	Thermostat with Custom Broil [Off - Broil - 500 ... 150]	Adjustable Fig. 8 Clip Right*
1	3149988	Thermostat with Clean and Custom Broil [Off - Clean - HI Broil - 500 ... 150]	Adjustable Fig. 8 Clip Right*

*Looking at shaft side, clip is on right. Thermostat knobs are adjustable for temperature accuracy.

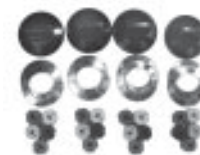

RK100



RK101



RK102



RK103

Universal Electric Range Knob Kits

Supco No.	Type	Replaces	Color	Number of Knobs	Inserts	Overlays
RK100	Electric	Kit	Black	4	20	Surface
RK101	Electric	Kit	Black	1	5	Surface & Oven
RK102	Electric	Kit	Black	1	5	Oven
RK103	Electric	Kit	Black	5	25	Surface & Oven

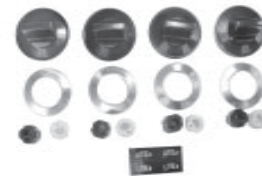

RK200



RK201

Universal Gas Range Knob Kits

Supco No.	Type	Replaces	Color	Number of Knobs	Inserts	Overlays
RK200	Gas	Kit	Black	4	8	Surface
RK201	Gas	Kit	Black	1	2	Surface & Oven
RK203	Gas	Kit	Black	5	10	Surface & Oven
RK401	Gas	Kit	White	1	2	Surface



RK203



RK401

Universal Gas or Electric Range Knob Kits

Most Universal Knob Kit - Design allows this knob kit to be used on Gas or Electric ranges. The overlays and inserts cover Surface or Thermostat applications.

Supco No.	Type	Replaces	Color	Number of Knobs	Inserts	Overlays
RK701	Both	Kit	Black	1	7	Surface & Oven

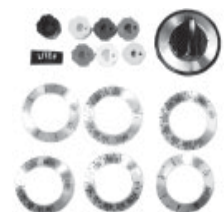

RK701

Range Accessories

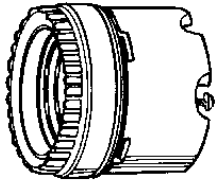

GA25
Range Lamp Holder
2 piece Porcelain
White
Max. 660 W @ 250 V

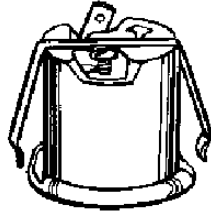

GA26
Range Lamp Holder
Snap-in Phenolic
Black
Max. 660 W @ 250 V

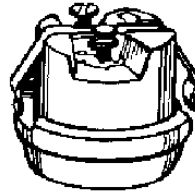

GA27
Range Lamp Holder
Snap-in Porcelain
White
Max. 660 W @ 250 V

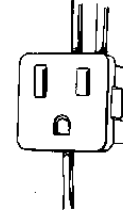

GA28
3 Wire Outlet
Snap-in Plastic
White
15 Amp @ 115 Volts

Appliance Light Bulbs

Appliance, Refrigerator, Oven Lamps/Bulbs

SUPCO Part No.	GEM No.	ROBERTSHAW No.	Watts	Volts	Bulb Shape	Packaged Quantity	Description/ Base
15T7C	LT006	87-006	15W	130V	T	25	Clear/Candelabra
15T7DC	LT007	87-007	15W	130V	T	25	Clear/Bayonet D.C.
25T61/2	LT008	87-008	25W	130V	T	25	Clear/Interm. Screw
25T61/2DC	LT009	87-009	25W	130V	T	25	Clear/Bayonet D.C.
25T8N	LT010	87-010	25W	130V	T	25	Clear/Interm. Screw
25T8DC	LT011	87-011	25W	130V	T	25	Clear/Bayonet D.C.
40A15	LT012	87-012	40W	130V	A	100	Gen'l Purpose/Med.
40T61/2	LT013	87-013	40W	130V	T	25	Clear/Interm. Screw
40T10	LT014	87-014	40W	130V	T	25	Clear/Med. Screw
40T10IF	LT018	87-018	40W	130V	T	25	Frstd./Interm. Screw

Pilot and Indicator Lamps/Bulbs

6S6	LT001	87-00	6W	130V	S	50	Clear/Candelabra
6S6DC	LT002	87-002	6W	130V	S	50	Clear/Bayonet D.C.
7C7	LT003	87-003	7W	130V	C	50	Clear/Candelabra
10C7	LT004	87-004	10W	130V	C	50	Clear/Candelabra
10C7DC	LT005	87-005	10W	130V	C	50	Clear/Bayonet D.C.

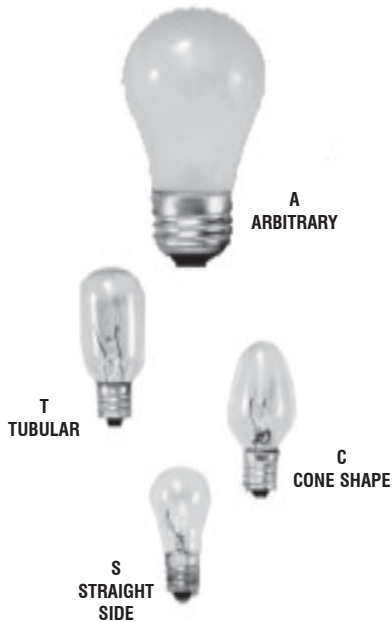

Meters

Infrared Thermometers



PIT1

- 1:1 Optical Ratio
- Pocket Size
- Min/Max Measurements



LIT6

- 6:1 Optical Ratio
- Laser Pointer
- Backlight



LIT8B

- 8:1 Optical Ratio
- Laser Pointer
- Trigger Style
- Backlight



LIT11TC

- 11:1 Optical Ratio
- Laser Pointer
- High & Low Temperature Range
- Backlight
- Carrying Case Included



LIT50

- 50:1 Optical Ratio
- Laser Pointer
- High & Low Temperature Range
- Backlight
- Carrying Case Included

Laser Infrared Thermometers offer precise, non-contact measurement in a lightweight, hand held instrument. With one hand operation, they are ideal for a wide variety of applications.

Applications

- Refrigeration Systems
- Heating Systems
- Supply and Return Registers
- Circuit Breaker Panels
- Motors/Bearings
- Transformers
- Ducts
- And More

Application Note:

What is Distance to Spot Ratio (D:S)?

This is the size of the measurement field that a non-contact infrared thermometer uses to provide a temperature reading. The infrared thermometer averages the temperature of that field to calculate the temperature reading. For example, a D:S ratio of 8:1 means that the measurement field measures approximately 1 foot in diameter when the target is approximately 8 feet away.

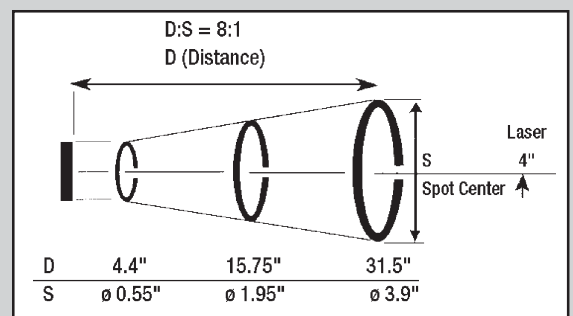

- K-Type Thermocouple (probe included)
 - Temperature Range 58°F to 482°F (14°C to 250°C)
 - Full range: -83.2°F to 1999°F (-64°C to 1400°C)
 - Temperature Accuracy +/- 1% of reading or 2°F

Emissivity:

The ability of a surface to reflect the infrared radiation relative to an ideal surface. A flat black surface is as close to ideal as you can get. Most infrared thermometers have a fixed emissivity of .95. The more reflective the surface the lower the emissivity adjustment should be.

Infrared Specifications

	PIT1	LIT6	LIT8B	LIT11TC	LIT50
Optical Ratio	1:1	6:1	8:1	11:1	50:1
Temperature Range	-27°F to +428°F (-33°C to +220°C)	0°F to +500°F (-18°C to +260°C)	-4°F to 518°F (-20°C to 270°C)	-76 °F to 932°F (-60°C to 500°C)	-58°F to 1832°F (-50°C to 1000°C)
Best Resolution	0.1°C or °F	1°F (1°C)	1°F (1°C)	0.1°F	0.1°F
Accuracy	±2% of reading or ±2°C	±2% of reading or ±2°C	±2% of reading or ±4°F (2°C)	+/- 2°F (+/- 1°C)	+/- 2% of reading or ±4°F (2°C)
Emissivity	0.95 adjustable	0.95 fixed	0.95 fixed	0.95 adjustable	0.95 fixed
Automatic shut off	Yes	Yes	Yes	Yes	Yes
Power Supply	CR2032 (Included)	9V Battery (Not Included)	9V Battery (Included)	2 AA Batteries (Included)	9 V Battery (Included)
Weight	1.3 oz. (32g)	5.3 oz. (150g)	5.8 oz. (180g)	6.3 oz. (179g)	10.23 oz. (290g)
Dimensions	.7" X 1.5" X 2.7" (18mm X 37mm X 68mm)	5.1" X 2" X 1.25" (18mm X 50mm X 42mm)	6.4" X 3.2" X 2.4" (159mm X 79mm X 57mm)	6.9" X 1.5" X 2.8" (175 X 39 X 71mm)	3.94" X 2.2" X 9.06" (100 X 56 X 230 mm)

Meters

Digital Thermometers

Applications

- Superheat Measurements (T1-T2)
- Oven Temperature measurements
- Ambient Temperature Measurements
- Surface Temperature Measurements
- Food Service
- Measure HVAC and Refrigeration System Temperatures



DT12 Digital Thermometer

The full ranging DT12 Digital Thermometer comes complete with a K-type thermocouple oven clip probe and is housed in a sturdy rubber boot for accurate and reliable temperature measurements.

Features/Benefits

- K-Type Thermocouple Probe with Oven Clip Included
- Range -112°F to 1832°F (-80°C to 1000°C)
- Protective Rubber Boot Included
- Low Battery Indicator
- 3 Year Warranty
- Low Battery Indicator
- 3 Year Warranty



DT22 Dual Digital Thermometer

The Dual Input DT22 Digital Thermometer comes complete with two (2) K-type thermocouples. Providing Temperature Differential Measurement (T1-T2), it is ideal for superheat applications.

Features/Benefits

- Two (2) K-Type Thermocouple Probes Included
- Range -328°F to 2498°F (-200°C to 1350°C)
- Temperature Differential Measurement (T1-T2)
- K-Type and J-Type Thermocouple Selectable
- Min/Max Record
- Data Hold
- Protective Rubber Boot Included
- Auto Shut Off
- Low Battery Indicator
- 3 Year Warranty



DDT2 Digital Differential Thermometer

With its Dual Display, the DDT2 provides instant measurements for two Temperature points (T1,T2) and their difference (T1-T2). Optional PC Software (DDT2S) allows for analysis of trend data.

Features/Benefits

- Dual K-Type Thermocouple Inputs
- Temperature Differential Measurement (T1-T2)
- Records Up to 8 Min/Max/Avg Measurements
- Relative Function provides instant Temperature Difference between successive measurements
- Dual Display
- Auto-Ranging
- Data Hold
- Auto Power Off
- Vinyl Case Included



PT100 Digital Pocket Surface Thermometer

Applications

- Speedy recovery - reclaim temperature measurement
- Measures evaporator plate and condensing temperatures
- Air inlet, outlet and surrounding air

Features

- Ultra sensitive air and surface reading probe
- Provides fast response—within seconds
- Temperature “HOLD” switch—keeps readings fixed



PART NO.	DESCRIPTION
PT100	Fahrenheit Model
PT100C	Celsius Model
PT100H	High Temp. Fahrenheit
PT100HC	High Temp. Celsius

K-Type Thermocouple Probes

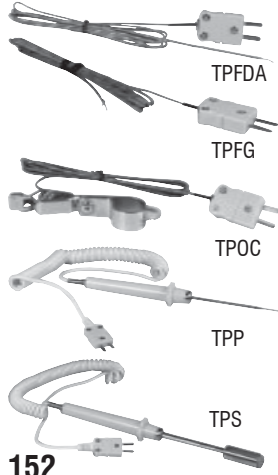

Temperature Probe Specifications

	TPFDA	TPFG	TPOC W/ OVEN CLIP	TPP PIERCING	TPS SURFACE
Temp. Range:	-40°F to 950°F -40°C to 510°C	-40°F to 950°F -40°C to 510°C	-40°F to 950°F -40°C to 510°C	-58°F to 482°F -50°C to 250°C	-58°F to 1202°F -50°C to 650°C
Subminiature connector	*	*	*	*	*
4' bead tip probe with FDA approved insulation	*				
3.7" heavy duty chisel tip insertion probe with handle and 4' cord			*		
4" heavy duty spring loaded tip surface probe with handle and 4' cord				*	

Meters

Temperature and Humidity Tester Specifications

	DT12	DT22	DDT2	PT100	TPM110	THP2	THC200
# of inputs	1	2	2	1	1	1 Temp./1 Hum.	1 Temp./1 Hum.
Thermo - couple Type	K	K, J	K		J		
Differential		*	*				
Data Hold		*	*	*			
Min/ Max		*	*				*
Dual Display			*				Triple Display
Auto-Off	*	*	*				
Temp. Range	-112°F to 2462°F -80°C to 1000°C	K-Type -112°F to 2462° F -80°C to 1000° C J-Type -328°F to 1832°F -200°C to 1000°C	-328°F to 2498°F -200°C to 1370°C	PT100/PT100C -40°F to 199.9°F -40°C to 93.28°C PT100H/PT100HC -40°F to 250°F -40°C to 120°C	-70°F to 199°F -56.67°C to 93.28°C	-4°F to 122°F -20°C to 50°C	-4°F to 122°F -20°C to 50°C
Temp. Resolution	0.1°F -112°F to 299°F 1°F (300 +°F)	0.1°F -328°F to 999.9°F 1°F (1000 +°F)	0.1°F -200°F to 200°F 1°F otherwise	0.1°F -40°F to 199.9°F 1.0°F (-40° to 250°F)	1.0°F	0.1°F	0.1°F
Temp. Accuracy	±0.5% Rdg +1.8°F (-58°F to 1832°F)	±0.3% Rdg +1.8°F	±0.5% Rdg +2°F	0.2 Surface 1.0 Air	±1°F	±2°F	±1.8°F or 1.0°C
Humidity Range						10% to 90% RH	25% to 95% RH
Humidity Resolution						1% RH	1% RH
Humidity Accuracy						±5% for -40% to 80% RH otherwise	±5% RH ±7%
Power	AAA (2) Batteries	9V Alkaline	9V Alkaline	9V Alkaline	120/240V 50/ 60 Hz	Button cell (1) LR44	AA (2) Batteries
Size (HxLxW)	1.8" x 6" x 3"	1.8" x 6" x 3"	7.25" x 2.5" x 1.4"	1.5" x 6.75" x 0.8"	3.38" X 3.38"	6.5" X 1.75" X .6"	4.38" X 2.75" X 0.5"
Weight	7.2 oz	7.2 oz	7.4 oz				
Warranty	3 year	3 year	1 year	1 year	1 year	1 year	1 year



DSP1000 Digital Psychrometer

The DSP1000 provides fast, accurate measurements for analysis of critical environmental conditions.

- Temperature
- Humidity
- Fast Response
- Dual Display
- Max Hold
- No Twirling
- No Reading Charts
- No Water Necessary

Features

- Fast Response Time
- High Accuracy
- Temperature
- Humidity
- Dewpoint Temperature
- Wet Bulb Temperature
- Max Hold
- Data Hold Function
- Micro Processor-based Design
- Dual Display Temperature & Humidity
- Auto Power Off (Disable Sleep mode)
- Backlight
- 1 Year Warranty



Applications

- Cellophane
- Chemical
- Laboratory
- Pharmaceuticals
- Textile
- Paper
- Photographic
- Printing
- Snowmaking
- Tobacco
- Indoor Air Quality
- Wine Storage
- Floral
- Meat

Specifications

RANGE	
Humidity	0-100% RH (Non-Condensing)
Temperature	-22°F to 212°F (-30°C to 100°C)
Dewpoint Temperature	-22°F to 212°F (-30°C to 100°C)
Wet Bulb Temperature	32°F to 176°F (0°C to 80°C)
ACCURACY	
Humidity	±2% RH (20% RH to 80% RH) ±2.5% RH (all other ranges)
Temperature	±0.9°F/±0.5°C (at 77°F/25°C) ±1.5°F/±0.8°C (all other ranges)
Resolution	0.01% RH, 0.01°F/0.01°C
Response Time	10s (90% at +77°F (+25°C) still air)
Battery Type	9V Battery NEDA 1604, IEC 6F22 (included)
Operation Temperature	32°F to 104°F/0°C to 40°C (<80%RH)
Storage Temperature	14°F to 140°F/-10°C to 60°C (<70%RH)
Size (H X W X D)	8.86" X 1.77" X 1.34" (225mm X 45mm X 34mm)
Weight	7.05oz (200g)

Thermometers



THP2 Thermo-Hygrometer Pen

Features/Benefits

- Measures Temperature & Humidity, Simultaneously
- Dual Display
- Temperature in °F or °C
- Pocket Clip
- Battery Included
- Min/Max Memory



THC200 Thermo-Hygrometer w/ Clock

Features/Benefits

- Table top or wall mount
- Measure Temperature and Humidity Simultaneously
- Real Time Clock
- Set High and Low Alarms for Temperature and Humidity
- Temperature Range: -4°F to 122°F (-20°C to 50°C)
- Humidity Range: 25% to 95%
- °F/°C Switchable
- Min/Max



TPM110 Temperature Indicator

A highly reliable, extremely accurate temperature indicator. Custom designed faceplates with your company name or logo are available with quantity orders.



Features/Benefits

- Large LCD display
- Easy installation
- Thermocouple wire can be extended to 500'
- Can calibrate in the field

Applications

- Direct replacement for old style 2 1/4" and 2 1/2" dial gauges
- Commercial Refrigeration/Freezer Panels
- Hospital/Laboratory Control Panels

PART NO.		
TPM110	110 VAC	Fahrenheit Model
TPM110C	110 VAC	Celsius Model
TPM220C	220 VAC	Celsius Model

Pocket Digital Thermometers

ST09

- -40°F to 392°F (-40°C to 200°C)
- Accuracy: +/-2°F between -14°F to 212°F (+/-1°C between -10°C to 100°C)
- Min/Max
- F°/C° Switch
- Protective Sheath
- Data Hold
- ON/OFF Switch
- Pocket Clip
- Battery Included (STBAT)
- Drop Resistant
- Waterproof
- 2 1/2" Long Stem

Applications

- Refrigerators/Freezers
- Food Processing/Prep.
- Heating/Ventilating

ST10

- -50°F to +392°F (-45°C to +200°C)
- Accuracy: +/-2°F or +/-1°C
- F°/C° Switch
- Large LCD
- Display updates every second
- Battery included. Free spare battery (STBAT)
- Pocket clip
- 4 23/32" (12cm) stainless steel stem

Pocket Dial Thermometers

ST01/ST02

- 1" dial
- 5" stem
- °F only
- Recalibration adjustment
- Temperature Range:
ST01 -40°F to 160°F
ST02 0°F to 220°F

ST07/ST08

- 1 3/4" dial
- 5" stem
- °F and °C
- Recalibration adjustment
- Temperature Range:
ST07 0°F to 220°F (-18°C to 105°C)
ST08 -40°F to 160°F (-40°C to 70°C)

Application

- Air Conditioners
- Refrigerators/Freezers

Appliance Thermometers

ST03/ ST04

- Stainless Steel Construction
- Hangs or stands
- °F and °C
- Unbreakable lens

ST06

- Horizontal design
- °F and °C

PART NO.	TEMPERATURE RANGE	APPLICATION
ST03	-20°F to 80°F (-30°C to 27°C)	Refrigerators
ST04	100°F to 600°F (38°C to 315°C)	Ovens
ST06	-40° to 80°F (-40° to 27°C)	Refrigerators/Freezers

- Stainless steel wire clips for easy hanging

Temperature Alarms & Controls



TA Series Temperature Alarms

All of your temperature sensitive areas are protected with the broadest line of temperature alarms: single and dual set point, wireless remote, battery operated and multi-channel. Select the right one for your application.

Features/Benefits

- Adjustable alarm temperature ranges
- Audible and visual alarm
- Built-in terminals for remote alarm or telephone dialer connection (except TA7)
- Alarm switch for 'No delay' or '1 hour delay'

TA2 Single Set Point Temperature Alarm

A reliable, inexpensive alarm for refrigerators and freezers. Just flip a switch to activate alarm on a rise or fall in temperature.

- Adjustable Range from -10°F to +80°F (-25°C to +30°C)



TA6 Dual Set Point Temperature Alarm

Alarms on a rise **AND** fall in temperature.

- Adjustable Range from -10°F to +80°F (-25°C to +30°C)

TA7 Battery Operated Temperature Alarm

For sensitive temperature applications in remote areas, this battery operated unit is inexpensive and easy to install. Alarms on rise in temperature only.

- Adjustable Range from -10°F to +80°F (-25°C to +30°C)



Applications

- Food Markets, Convenience Stores, Supermarkets
- Restaurants, Florists, Greenhouses
- Laboratories, Pharmaceutical Storage Facilities
- Refrigerated Transport, Cold Storage Facilities
- Computer

MODEL NO.	
TA2	120 VAC Fahrenheit Model
TA2C	120 VAC Celsius Model
TA2-220	220 VAC Fahrenheit Model
TA2-220C	220 VAC Celsius Model



MODEL NO.	
TA6	120 VAC Fahrenheit Model
TA6C	120 VAC Celsius Model
TA6220	220 VAC Fahrenheit Model
TA6C220	220 VAC Celsius Model



MODEL NO.	
TA7	Fahrenheit Model
TA7C	Celsius Model

Temperature Alarm Specifications

	TA2	TA6	TA7
Alarm Channels	1	2	1
Alarm Adjustment Range	-10°F to 80°F (-25°C to 30°C, Celsius model)	-10°F to 80°F (-25°C to 30°C, Celsius model)	-10°F to 80°F (-25°C to 30°C, Celsius model)
Probe	Encapsulated sensor with 6 ft. cord	Encapsulated sensor with 15 ft. cord	Encapsulated sensor with 6 ft. cord
Sensor Type	Thermistor	Thermistor	Thermistor
Maximum Probe extension	200 ft.	200 ft.	100 ft.
Temperature Accuracy (Display)			±2°F at 75°F ambient
Remote Alarm Connections	Screw type, 120 VAC, 5 Amps (dry contacts)	Screw type 120 VAC, 5 Amp max., (dry contacts)	None
Power	120 V AC (220 V optional)	120 V AC (220 V optional)	9 V alkaline battery (not included)
Case	Hi-impact thermoplastic	Hi-impact thermoplastic	Hi-impact thermoplastic
Mounting	Surface, external holes provided	Surface, external holes provided	Surface, adhesive pads/keyhole slot
Dimensions	3" x 4 7/8" x 1 5/8"	3" x 4 7/8" x 1 5/8"	5 3/4" x 1 1/2" x 1"
Weight	13 oz	13 oz	5 oz
Warranty	1 year	1 year	1 year

Temperature Alarm Accessories

Temperature Alarm Accessories

		TA2	TAL2	TA4	TA6	TA7	TA3	TAP4										
SW25	25' Extension Wire	*	*		*	*		*	TA2PROBE	Probe w/ 6' extension wire	*							
SW50	50' Extension Wire	*	*		*	*		*	TA6PROBE	Probe w/ 6' extension wire		*						
SW75	75' Extension Wire	*	*		*	*		*	TA7PROBE	Probe w/ 4' extension wire			*					
SW100	100' Extension Wire	*	*		*	*		*	14265	Replacement Sensor		*						*
TCW25	25' Type J Thermocouple Wire			*			*		USBS	USB to Serial Interface		*						
TCW50	50' Type J Thermocouple Wire			*			*		13495	Serial Port Cable		*						
TCW75	75' Type J Thermocouple Wire			*			*		ADTA	Auto Dialer	*	*	*	*	*	*	*	*
TCW100	100' Type J Thermocouple Wire			*			*											
TA3P	Probe w/ 6' Type J Thermocouple Wire							*										
TA4P	Probe w/ 6' Type J Thermocouple Wire			*														

Specialty Meters

MADE IN THE
USA

MFD10 Digital Capacitor Tester

With its one hand operation, the MFD provides the fastest measurements for capacitor values.



Features/Benefits

- Range 0.01 to 10,000 mF
- Accuracy $\pm 5\%$
- Test clip storage within case
- Alligator clips to capacitor terminals
- LED display
- One button operation
- Operates on one 9V Battery (not included)
- Soft carrying case included

Applications

- Verification of Start and Run Capacitors
- Checks for open and short capacitors
- Identify unmarked capacitors
- Confirms weak capacitors
- Use as continuity tester

Specialty Instrument Selection Guide

- Measurement/Function - Capacitance
- Range - 0.01 to 10,000 MFD

Standard Accessories

PART NO.
MFDCASE Soft Case
MDFUSE Fuse

WA100 Water Alarm w/Remote Sensor

Protect property and valuable possessions. With its 85dB alarm, the WA100 will alert you immediately of the presence of water.



Features/Benefits

- 85 dB alarm sounds for up to 3 days.
- Remote sensor has 6 foot wire
- Dual position sensor
- Test button
- Wall mountable alarm



Applications

- Warns of leaks and overflows
- Alerts user when desired water level is reached (i.e. pools)
- Kitchen, laundry, furnace, computer room, pools, aquariums, more...



CR87B - Temperature Recorder

Applications

- Designed for Refrigerators/Freezers, Laboratory and Environmental Applications
- Measures and records temperature in air, gas, liquids, powders, solids, and semi-solids



Features/Benefits

- Temperature range: -40°F to 120°F (-40°C to 50°C)
- Remote readings from up to 100 ft. (optional sensor wire p/n CABLE10T)
- Programmable speed and temperature ranges

PART NO.	TEMP. READING IN	OPERATING VOLTAGE
CR87B	Fahrenheit	110-120V, 50/60 Hz
CR87BC	Celsius	110-120V, 50/60 Hz
CR87B220	Fahrenheit	220-240V, 50/60 Hz
CR87B220C	Celsius	220-240V, 50/60 Hz

CR87B Series Recording Charts

TEMP. RANGE	6 Hrs.	24 Hrs.	7 Days	31 Days
-40°F to 30°F	CR87-4	CR87-1	CR87-7	CR87-19
-20°F to 50°F	CR87-5	CR87-2	CR87-8	CR87-20
50°F to 120°F	CR87-6	CR87-3	CR87-9	CR87-21
-40°C to 0°C	CR87-13	CR87-10	CR87-16	CR87-22
-30°C to 10°C	CR87-14	CR87-11	CR87-17	CR87-23
10°C to 50°C	CR87-15	CR87-12	CR87-18	CR87-24

VG64 Digital Vacuum Gauge

Suitable for field or laboratory use, the VG64 delivers high precision at a low price.



Features/Benefits

- Ultra fine resolution: (1 Micron when vacuum ≤ 200 Microns)
- Reads vacuum in 7 international units
- Display updates every 1/2 second
- Convenient built in hanger
- Cleaning port provides quick cleaning and drying of sensor

MADE IN THE
USA

Accessories

PART NO.	
10475	120 V Power Adapter
MFDCASE	Soft Pouch
VGC	Vacuum Gauge Coupler

Multimeters & Current Probes

Digital Multimeters



DM10T Economy Digital Multimeters with Temperature

The DM10T Digital Multimeter provides an economical solution to your everyday electrical and temperature measurement needs.

Features/Benefits

- 1000 Volts DC
- Continuity
- 10 Amps DC
- 750 Volts AC
- Temperature

Current Probes



CPH100 HVAC Current Probe

Features/Benefits

- 400 Amps AC
- DC μ Amps
- AC/DC Volts
- Resistance
- Capacitance
- Temperature
- Frequency
- Continuity
- Auto Shut off
- 1 year Warranty



Applications

- HVAC Equipment Consumption
- Flame Safeguard circuits (CPH100)
- Branch Circuit Current
- AC Line and Control Voltages
- Continuity Check
- Temperature Testing
- Capacitor Testing



CP070 Open Jaw Multi Probe

Features/Benefits

- Simultaneous measurements: 200 Amps AC and one of the following:
 - AC or DC Volts
 - Resistance
 - Capacitance
 - Frequency
- Two LCD displays
- 3 year Warranty

Optional Accessories



TPA1 Temperature Adapter

The TPA1 Temperature Adapter can be used with digital multimeters having 200mV or 2V DC ranges and analog multimeters having DCmV ranges up to 300mV DC.

Features/Benefits

- Measures up to 500°F
- Uses K-type thermocouple

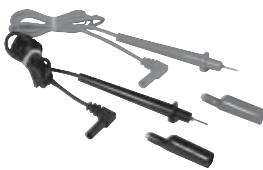

TLA Test Leads

- 1000V AC or DC max
- 10 Amps max
- Includes screw-on alligator clips



SCDM/SCCP Soft Deluxe Cases

Features/Benefits

- Rugged Cordura Case
- Zippered Case

Soft Case Dimensions

PART NO.	DIMENSIONS
SCDM	6 1/4" Wide 9 3/4" Long 2 1/2" Deep
SCCP	5 1/4" Wide 7 1/4" Long 2 1/2" Deep



TPFDA FDA Approved Temperature Probe



TPFG Fiberglass Temperature Probe

Multimeters & Current Probes

	DM10T	CP070	CPH100
Volts AC	750	600	600
Volts AC Best Resolution	1 V	1mV	0.1mV
Volts DC	1000	600	600
Volts DC Best Resolution	0.1 mV	0.1mV	0.1mV
Amps AC	10	200A	400A
Amps AC Best Resolution	0.1mA	100mA	0.1A
Amps DC			
Amps DC Best Resolution			
Frequency (Hz)		9.999MHz	150.0KHz
Frequency Best Resolution		0.001Hz	0.001Hz
Base Accuracy (DC Volts) (AC Amps)	± 0.5% ± 2 dgts	± 1.2% ± 2 dgts ± 3.0% ±3 dgts	± (1.5% +3 dgts) ± (2.0% + 3 dgts)
Resistance max. (Ohms)	2 M	40M	40M
Continuity	Yes	Yes	Yes
Capacitance		200µF	100.0µF
Capacitance Best Resolution		1pF	0.01nF
Temperature	-4 °F to 2498° F (DM10T) (-20° C to 1370 °C) (DM10T)		-50°F to 2372°F -5°C to 1300°C
Temperature Accuracy	±3 ± 2 digits		±(3% +5 digits)
Display (Counts)	2,000	2,000	4,000
Data Hold		Yes	Yes
Sleep Mode			Auto Shut Off
Operating Temperature	32° F to 74° F (0°C to 23°C)	14°F to 122°F (-10°C to 50°C)	14°F to 122°F (-10°C to 50°C)
Storage Temp. Temperature		-22°F to 140°F (-30°C to 60°C)	-22°F to 140°F (-30°C to 60°C)
Relative Humidity	0% to 75% RH	0% to 90% RH	0% to 90% RH
Fuse Protection	mA: 0.2A/ 250V		
Power	9 V Battery (included)	2 AA Batteries (included)	2 1.5V AAA Batteries (included)
Size (HxLxW)	5.5"L x 3"W x 1.5"D (140mm x 76mm x 36mm)	8.5" X 2.0" X 1.7" (216mm x 51mm x 43mm)	7.9" X 2.0" X 1.4" (200mm X 50mm X 35mm)
Weight	8 oz (227 g)	16oz. (454g)	7.1 oz (200g)
Warranty	1 Year	3 Year	1 Year

Digital Multimeters & Current Probe Accessories

PART NO.	DESCRIPTION	DM10T	CPH100
Standard Accessories (Included)			
TLA	Test Leads w/ Alligator Clips		•
TPFG	Fiberglass Temperature Probe		•
	9 V Battery		•
	AAA Battery		2

Optional Accessories

PART NO.	DESCRIPTION	DM10T	CPH100
TPFDA	FDA Approved Temperature Probe		•
SCDM	Soft Carrying Case		
SCCP	Soft Case Case	•	•

Tools



4 in 1 Multi-Socket

Features/Benefits

- Replaces the four most common nut drivers. SAE socket sizes 1/4", 3/8", 5/16", 7/16".
- Telescoping action provides two socket sizes at each end.
- Push right for 5/16" or 3/8" socket.
- Push left for 7/16" or 1/4" socket.
- High-torque grip textured, non-slip surface.
- Tough, high-quality industrial steel construction.



PART NO.	
SAB601	Countertop Display of 12

Security Multi-Driver

Features/Benefits

- Features extra-long 3" nosepiece reaches even recessed fasteners.
- Hard-wearing, heavyweight tool for professionals working with security fasteners.
- Includes 14 security tips plus 2 standard tips on eight 3" long, double-ended bits.



Bits Included

HEX SECURITY	1/8", 9/64", 5/32", 3/16"
SPANNER	4, 6, 8, 10
ROBERTS SECURITY	1, 2
TORX™ SECURITY	10, 15, 20, 25
PHILLIPS	2
SLOT	7/32

PART NO.	
SAB454	Countertop Display
SAB454R	Display Refill
SAB444	Clamshell Packaging

Classic Multi-Driver

Features/Benefits

- Standard size driver. Replaces 16 of the most frequently used bits.



Bits Included

HEX	3/32", 1/8", 5/32", 3/16"
ROBERTS	2, 3
SLOT	1/4", 3/16"
TORX™	15, 20, 25, 30
PHILLIPS	0, 1, 2, 3

PART NO.	
SAB243	Countertop Display of 12
SAB243R	Display Refill
SAB233	Clamshell Packaging

Ratchet Multi-Driver

Features/Benefits

- Heavy-duty reversible ratchet mechanism.
- Adjustable angle nosepiece swivels 180° and locks into the angle you need.
- Also available with a 7-piece SAE socket set which includes these sockets: 3/16", 5/16", 3/8", 7/16", 11/32", 1/2", Plus adapter bit.



Bits Included

HEX	3/32", 1/8", 5/32", 3/16"
ROBERTS	2, 3; SLOT 1/4", 3/16"
TORX™	15, 20, 25, 30
PHILLIPS	0, 1, 2, 3

PART NO.	
SAB505	Countertop Display of 12
SAB505R	Display Refill
SAB510	Clamshell Packaging
SAB515	Driver with SAE Socket Set (clamshell packaging)

Ratio Multi-Driver

Features/Benefits

- Multi-driver replaces 16 screwdrivers.
- 4 to 1 ratio nosepiece turns four times with each turn of the handle.
- 1 to 1 ratio nosepiece turns with the handle.
- Reversible ratchet changes direction quickly with one hand, even during use.
- 8 extra-long (3") double-ended bits. Bits store in the handle and a 1/4" nut driver in the nose.
- Handle has separate bit compartments and end cap that allows individual bit selection; won't turn during use.
- Industrial quality bits are hardened S2 steel.
- Countertop display packaging is reusable.



Bits Included

HEX	3/32", 1/8", 5/32", 3/16"
ROBERTS	2, 3
SLOT	1/4", 3/16"
TORX™	15, 20, 25, 30
PHILLIPS	0, 1, 2, 3

PART NO.	
SAB705	Countertop Display of 12
SAB705R	Display Refill
SAB710	Clamshell Packaging

Tools



Replacement Bits

Features/Benefits

- Universally sized for power tools or as replacement parts for Select-A-Bit™ Multi-Drivers
- 3" long, double-ended, hardened S2 steel bits.
- Security (taper-proof) and standard sizes available.



00210 Torx™ 15-20	00230 Hex 3/32"-1/8"
00211 Torx™ 25-27	00231 Hex 3/16"-5/32"
00212 Torx™ 25-30	00232 Hex 7/32"-1/4"
00213 Torx™ 30-40	00270 Slot 5/32"-7/32"
00250 Torx™ 0-1	00271 Slot 3/16"-1/4"
00251 Torx™ 2-3	00290 Roberts 0-1
00280 Torx™ 2-Slot 7/32"	00291 Roberts 2-3

Security Bits

00310 Torx™ Security 7-8	00330 Hex Security 1/8"-5/32"
00311 Torx™ Security 9-10	00332 Hex Security 3/16"-5/32"
00315 Torx™ Security 10-15	00333 Hex Security 1/8"-9/64"
00312 Torx™ Security 15-20	00350 Spanner Security 4-6
00316 Torx™ Security 20-25	00351 Spanner Security 8-10
00313 Torx™ Security 25-27	00360 Roberts Security 1-2
00314 Torx™ Security 30-40	

Hi Torx™ 6 in 1 Driver

Features/Benefits

- 6 in 1 driver available with standard or security (tamper-proof) bits. Has a nut driver on each end and double-ended bits.
- Handle ergonomic. Oversized, tapered, three-sided, maximizes torque force, minimizes exertion for less hand fatigue.
- Kraton rubber grip handle coating tacky, non-sticky surface, for a non-slip grip—even when wet or oily.
- Durable double-ended bits are hardened S2 steel, nosepiece is chrome plated.



Standard Bit Load

PHILLIPS	1, 2; slot 3/16", 1/4"
NUT DRIVER	1/4", 5/16"

Security Bit Load

TORX™ SECURITY	15, 20, 25, 30
NUT DRIVER	1/4", 5/16"

PART NO.
ELB810 Standard
ELB811 Security

Flexible Lighted Magnet Pickup

Features/Benefits

- LED technology. Super-bright lights, no light bulbs to replace.
- Efficient illumination of the search area. Light is located at the magnet end; 23" total length.
- Strong 5 pound magnet.
- Magnet is encased in a brass shield. Directs the magnetic force to the tip, won't attract peripheral objects.
- Flexible pickup. Thin shaft that bends to any angle without breaking.
- Protective coating on shaft prevents rust and corrosion.
- Light turns off when not in use; just turn magnet end.
- Uses 3 button cell batteries (357/SR4 – included).



PART NO.
ELB904

Telescoping Lighted Magnet Pickup

Features/Benefits

- Telescoping magnet pickup telescopes to 26", collapses to 7"
- Telescoping pickup and mirror.
- Fits easily in a tool box.
- Pickup is available individually, or in a set that includes the telescoping mirror and carrying case.
- Oversized mirror (2.25" diameter) with a universal joint that adjusts to any angle telescopes to 36", collapses to 8"
- Telescoping pickup and mirror both feature a rigid, chrome-plated shaft with non-slip textured coating.



PART NO.	
ELB913	Telescoping Magnet Pickup (Pickup Only)
ELB910	Telescoping Pickup & Mirror (3 pc. Set Includes Pickup, Mirror, Case)

Nut Driver Set, 7 pc. SAE

Features/Benefits

- Color-coded hollow shafts accommodate longer fasteners.
- Extra-deep sockets securely grip nuts and bolts.
- Includes 7 SAE sizes: 3/16", 1/4", 5/16", 11/32", 3/8", 7/16", 1/2".



PART NO.
ELB717

2 in 1 Pocket Driver

Features/Benefits

- Double-ended bit seats firmly, won't slip during use.
- High quality, bit is chrome-plated to prevent rust; brass inset won't wear or crack.



Standard Driver

ELB801 bits: Philips #1, slot 3/16"

Electronic Driver

ELB802 bits: Philips #1, Slot 1/8"

Limited Lifetime Warranty for Select-A-Bit™ products: SUPCO will replace any driver parts that are damaged. Bits that are effective or damaged through normal use will be replaced for up to three years from date of purchase.

Tools



Innovative
TOOLS
INC.

Utility Jack Knife

Features/Benefits

- Lock-back design holds blade securely during use, folds to 3.5".
- Patented quick change blade mechanism allows you to slide in a new blade without disassembling the knife or using tools.
- No special blades to order. Accepts double-notched standard- and contractor- blades.
- Includes 5 spare blades in reusable blade holder.
- Stainless steel belt clip.



Innovative
TOOLS
INC.

Mini Utility Jack Knife

Features/Benefits

- Folds to 2.5". Compact, fits conveniently on an included key ring.
- Same quick change mechanism and heavy-duty construction
- 10 spare blades in reusable blade holder are included. Mini replacement blades are sold separately.



Innovative
TOOLS
INC.

2 in 1 Cutter/Stripper

Features/Benefits

- Cuts wire with one end, grabs and strips wire with the other.
- Stripper self-adjusts to wire; no stripping holes.
- 5" model strips stranded wire sizes 26 to 14 awg.
- 6" model strips electrical wire sizes 14 to 10 awg.
- Cutting head is full-flush cutting and low profile with stainless steel, induction-hardened jaws.

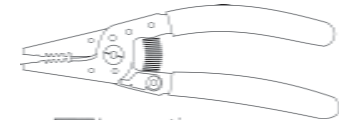

Innovative
TOOLS
INC.

Ergonomic Wire Stripper

Features/Benefits

- Ergonomic handles feature sealed air pocket cushion grips and curved design that delivers more force at the jaw, reducing hand fatigue.
- Stripping stations for solid and stranded wire sizes 10-20 AWG.
- Screw sizing stations for 6-32 and 8-32 screws.



Innovative
TOOLS
INC.

3 in 1 Multi Pliers

Features/Benefits

- Three interchangeable plier heads lock into place, won't slip during use.
- Double lever design yield twice the force of standard pliers.
- Handle of chrome molybdenum and PVC, warranted for life.
- Plier heads are induction-hardened carbon steel, which carry a three-year warranty.
- Set includes long nose, diagonal cutting and combination plier heads in a Velcro-close ripstop nylon holster.



Innovative
TOOLS
INC.

Heavy Duty Pliers Assortment

Features/Benefits

- Super heavy-duty oversized cross section, induction-hardened cutting edges and hot-riveted joints.
- Two-color textured non-slip handles.
- Professional quality materials and construction make this assortment a great value.



Innovative
TOOLS
INC.

Heavy Duty Pliers-11" Extended

Features/Benefits

- Specialty pliers, 11" reach and a choice of nose angles.
- Professional quality.
- Two-color textured handles.
- Model selection includes straight nose, or curves of 20°, 45°, or 90°.



Innovative
TOOLS
INC.

Torpedo Level 9"

Features/Benefits

- Three 360° vials are tinted for easy reading: one plumb, one level, one 45°.
- Magnetic strip and top read window.



PART NO.
RC5000 Knife Without Pouch in Disposable Countertop Display
RC5003 Knife with Ballistic Nylon Pouch

PART NO.
RC5010 Mini Utility Knife
RC5019 Mini Replacement Blades



PART NO.
ELB250 5" for Low Voltage Wire
ELB251 6" for Electrical Wire



PART NO.
ELB730



PART NO.
RC4300 3 in 1 Multi-Pliers



PART NO.	
ELB305	8" Diagonal Cutter
ELB304	7" Diagonal Cutter
ELB301	10" Crimping
ELB303	8" Long Nose
ELB302	9.5" Linesman
ELB312	8.5" Linesman



PART NO.	
ELB320	Straight
ELB322	90° Angle
ELB321	45° Angle
EL323	20° Angle



PART NO.
ELB714

Tools



Innovative TOOLS INC.

Heavy Duty Pliers-Telecom

Features/Benefits

- The most efficient pliers for telecom use cut, strip and crimp with one tool.
- Long nose pliers, one skinning hole to strip 22 awg wire and feature a cross-jaw grip.
- Diagonal cutting pliers, two skinning holes for stripping 16 and 22 AWG wire.
- Quality construction, drop-forged chrome vanadium steel with hot-riveted joint.
- Both models have induction-hardened cutting edges and crimper features between handles.
- Velcro-close ripstop nylon holster included with each tool.

NEW

PART NO.
ELB101 Long Nose
ELB201 Diagonal Cutting



Innovative TOOLS INC.

Ratcheting Pipe Wrench

Features/Benefits

- Oversized jaws automatically set-to-fit for one-handed operation.
- Ratcheting jaw doesn't require resetting between turns.
- Power jaw clamps tighter as you increase torque force.
- 360° Swivel head allows full leverage in tight spots.
- Heavy-gauge chrome vanadium steel has excellent durability.

NEW

PART NO.
RC3110 10" Wrench Opens to 4.5"
RC3114 14" Wrench opens to 2.5"



Innovative TOOLS INC.

Precision Adjustable Wrench

Features/Benefits

- Oversized jaw opens 18% wider than standard wrenches
- Dual calibrated jaw.
- Superior engineering.
- Oversized grip has superior balance to reduce hand fatigue.
- Constructed of heavy-gauge, industrial-quality steel insuring durability.

NEW

PART NO.
RC2104 4" spans 11/16"
RC2106 6" spans 15/16"
RC2108 8" spans 1 1/8"
RC2110 10" spans 1 5/16"
RC2112 12" spans 1 9/16"



Innovative TOOLS INC.

Box Joint Pump Pliers

Benefits/Features

- Heavy-duty box joint construction can't torque out, won't loosen with use.
- Self-gripping jaw pattern provides tight, secure grip, even on slippery pipes.
- Cushioned, non-slip grip.
- Industrial quality chrome vanadium steel with induction-hardened teeth.

NEW

PART NO.
ELB345 10"
ELB346 12"



Innovative TOOLS INC.

8 in 1 Multi-Wrench

Features/Benefits

- Chrome vanadium hardened steel with a solid shaft, chrome plated and rust resistant.
- Heavy-weight tool stands up to heavy use.
- Replaces 8 SAE wrenches: 5/16", 3/8", 9/16", 5/8", 7/16", 1/2", 11/16", 3/4".

NEW

PART NO.
SAB688 8 in 1 Multi-Wrench



Innovative TOOLS INC.

Dual Snap Ring Pliers

Features/Benefits

- Lighten your toolbox.
- All-in-one tool removes both internal and external snap rings.
- Spring-loaded over sized handle, cushioned for comfortable use.

NEW

PART NO.
ELB340 Snap Ring Pliers



Innovative TOOLS INC.

Electronic Digital Caliper

Features/Benefits

- 6" caliper, zero setting at any position.
- Conversion switch, instant conversion between millimeters and inches at any setting.
- High contrast, easy-to-read LCD digital display .
- Durable hardened stainless steel shaft.
- Uses one battery, type SR44 (included).
- One-year warranty.

NEW

PART NO.
ELB726 Digital Caliper

Technical Specifications

Measuring range:	0 - 150 mm/0 - 6"	Measuring system:	Linear capacitive measuring system
Resolution:	0+01 mm/0.0005"	Display:	LCD display
Accuracy:	0+02 mm/0.001"(< 100 mm) 0+03 mm/0.001"(> 100 mm)	Battery power:	One silver oxide 1+55v, type SR44
Repeatability:	0+01 mm/0.0005"	Max. measuring speed:	1+5 m/second, 60"/second

Tools



Electrician's Fish Stick Set

Features/Benefits

- Economical, efficient, and snarl-free way to pull or push wire.
- Safe, non-conductive flexible PVC plastic, bends easily around obstacles.
- Five-piece set contains 5 connectable rods, 24" long and 3/8" diameter.
- Includes 2 bull tip slotted heads for attaching wire.
- Rods feature rust-resistant internal connectors.
- Set includes nylon carrying case.



PART NO.	
ELB713 Fish Stick Set	



Pry-Angle™ Adjustable Prybar

Features/Benefits

- Clawhead is indexed to lock into 5 positions: 180° (straight), 155°, 130°, 105°, 80°.
- Super tough locking mechanism with thumb lever allows one-handed angle changes.



PART NO.	
RC1216	16" Prybar
RC1220	20" Prybar



Quick Release Tubing Cutter

Features/Benefits

- Auto ratchet closure sets to pipe automatically.
- Quick release, spring-loaded retractor releases pipe instantly.
- Lightweight aluminum body with built-in reamer feature.
- ELB401 1.25" Tubing Cutter cuts 1/8" to 1-1/4" o.d. copper tubing.
- ELB402 2" Tubing Cutter cuts 1/4" to 2" o.d. copper tubing.
- Replacement cutting wheels; replacements sold separately.



PART NO.	
ELB401	Cutter
ELB402	Cutter
ELB401/R	Replacement Wheel
ELB402/R	Replacement Wheel



Mini Tubing Cutter

Features/Benefits

- Tough, lightweight aluminum cutter for copper pipe 1/8" – 7/8" o.d.
- One Spare wheel included.



PART NO.	
ELB400	



Automatic Cable Tie Gun

Features/Benefits

- Fast, efficient cable tie gun.
- Tension adjustment wheel, choose preferred tension, automatically cuts when correct tension is reached.
- Fastens and cuts plastic cable ties in one motion.
- For use with ties up to 0.25".



PART NO.	
ELB720	

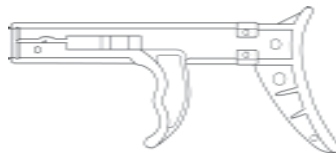

Mini Cable Tie Gun

Features/Benefits

- The right cable tie gun for small jobs.
- Compact size accommodates plastic cable ties up to 0.25" in width.
- Twist cable gun to cut and trim off excess cable tie length.



PART NO.	
ELB721	



Fish Tape

Features/Benefits

- Trigger for constant tension and finger grips around the reel keep the tape under control and retracting tightly.
- Tape reel cleans the tape as it retracts.
- Refills sold separately.



REFILL		
PART NO.		PART NO.
ELB710	50' Length	ELB710/R
ELB711	100' Length	ELB711/R



Cable Splicing Knife

Features/Benefits

- Coping-type blade is machined from fine cutlery steel.
- Non-slip, textured rubberized handle.
- Heavy-duty leather carrying sheath included.



PART NO.	
ELB701-L	



Painless Safety Cutter

Features/Benefits

- Prevent injuries from sharp cable ties—the safety cutter has a square cutting profile that blunt-cuts wire ties and other plastics.
- Professional quality, spring-loaded handles with precision ground, hardened steel jaws.
- To leave a blunt edge on wire tie bundles, place flush edge of cutter head toward the bundle, then cut.



PART NO.	
ELB400	

Tools & Accessories



CTP1- Capillary Tube Cutter

5" stripper and cutter. Fast, efficient and all purpose.



TC2 - Heavy Duty Tube Cutter

- For clean cuts in hard or soft copper aluminum, brass, thin wall steel and stainless steel.
- Rollers have flared cut off groove
- Complete with foldaway reamer blade and spare cutting wheel.

- Cuts tubes from 1/8" thru 1 1/8" O.D.
- Replacement cutting wheel p/n TC2W



UFC1 - Fin Comb

Cleans and straightens fins for better operating efficiency.



FPT10, FPT13 & FPT15 Fin Jack

Straightens and separates bent fins quickly and easily. One tool can be used for up to 3 sizes of fins.



FCR6 - Handy Ring Fin Comb Set

Six of the most popular Fin Combs covering twelve different size fins on a convenient ring. Includes FC0810, FC0915, FC1113, FC1214, FC1617, and FC1820.



Fin Combs

Straighten and clean evaporator and condensor fins.

PART NO.	DESCRIPTION
FPT10	9 & 10 Fins per inch
FPT13	11, 12 & 13 Fins per inch
FPT15	14, 15 & 16 Fins per inch

PART NO.	FINS PER		COLOR	PART NO.	FINS PER	
	INCH	INCH			INCH	INCH
FC0810	8 and 10		Orange	FC1617	16 and 17	Lime
FC0915	9 and 15		Yellow	FC1820	18 and 20	Red
FC1113	11 and 13		Blue	FC2224	22 and 24	Purple
FC1214	12 and 14		Green			



SF4311- "FasTap" Tube Piercing Pliers

- Fast refrigerant recovery: Just clamp and recover
- Tubing sizes 1/4" to 7/8" OD
- Replaceable self-sharpening tip

- Simple to use
- Light weight



SF4314 - Tube Piercing Pliers Replacement Tip



SF3970 - Internal Temperature Reading Tool

Take Internal Temperatures of Refrigerant Lines digitally.

- Accurately adjust superheat
- Simple instructions
- Inserts through access fitting (supplied)

Includes: Core Removal Tool and Digital Thermometer
Replaces SF3940 AND SF3960



DHS55 - Digital Handheld Scale

This compact handheld scale provides quick measurements for your refrigeration applications.

Features/Benefits

- 55 lbs max scale
- 2% accuracy
- One button operation
- Auto shut off

- Lbs/Kgs switchable
- Max weight memory
- 9 V battery included



HVT2 - Safe-T-Tester Screwdriver

- 110-220 VAC
- Light in handle indicates power



P85 "Tester Plus"

- 12-440 VAC
- Check Continuity, Voltage and Polarity



P89 - Voltage Detector

- 12-440 VAC

- Non-contact Voltage Detection



Tools & Accessories



ELD - Illuminated Inspection Mirror/Flashlight

- For previously inaccessible areas
- Push button and continuous "ON" twist switch.



Telescoping Tools

Match Clip, Magnet, and Inspection Mirrors

Features/Benefits

- Double ball joint head adjustment
- Extendable/retractable design
- Magnified glass mirror available with IM4
- Carry pouch included
- Glass Mirrors

PART NO.	DESCRIPTION	EXTENDED LENGTH
CT1	Heavy Duty Match Clip, Pocket Clip	26"
IM1	1.25" Round Glass Mirror, Pocket Clip	27"
IM2	1" x 2" Oval Glass Mirror, Pocket Clip	28"
IM3	2.25" Round Glass Mirror, Vinyl Grip Handle	14.5"
IM4	2.25" Round Magnifying Glass Mirror, Vinyl Grip Handle	14.5"
IM5	2.25" x 3.25" Rectangular Glass Mirror, Vinyl Grip Handle	15.5"
IMK3	Combination Tool, Pocket Clip Includes: Match Clip, Magnet, 2" Round Mirror & PVC Pouch	27"



417 - Drain Blaster

Hooks up to air tank or refrigeration hose to use as a high pressure blow-out for drains.



FWB1 - Fin Wisk Brush

Features

- Long lasting, sturdy Bristle Design



Air Conditioning & Refrigeration Wrenches

PART NO.	DESCRIPTION
RW516	1/4" - 3/16" Sq. x 3/8" - 5/16" Hex
RW916	1/4" - 3/16" Sq. x 1/2" - 9/16" Hex
RWA10	Hex adapter for refrigeration wrenches



S7L300 - Tension Tool

Tension tool for 120-175 lb. Duct Ties



MT100 - Magnetic Parts Tray



Blower Wheel Pullers

A fast and easy method to remove blower wheel from shaft without damage to the blower, blower motor or shaft.

PART NO.	DESCRIPTION
SF3500	Drive bolt shank and 1 1/4" hub
SF3510	Drive bolt shank and 1 3/8" hub
SF3515	1 3/8" hub only
SF3525	1 1/2" hub only
SF3535	1 5/8" hub only
SF3570	Blower wheel puller kit

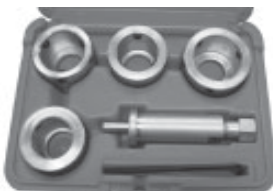

FBP100 - Fan Blade Puller

Features

- Sturdy, heavy duty steel
- 5/8" steel center shaft
- 4 pull fingers
- Alignment tool included
- Has flats for wrench
- Fine thread version provides additional torque & pulling power



Tools & Accessories



TC103 Test Cord

- 6', heavy duty, 16 gauge wire
- Male plug to medium duty spring clips
- 2 wire, black/red



TC104

- 24", heavy duty, 16 gauge wire
- Female plug to medium size spring clips
- 3 wire, black/red/green



TA3001

- 15' long, 1" nylon webbing
- Adjusts from 1' to 15'
- Ratchet handle w/ quick release

- Vinyl coated "S" hooks at each end
- 3000 lb. capacity



THS1441

- 12' long, 1" nylon webbing
- Adjusts from 1' to 12'
- Steel cam lever buckle for quick release

- Vinyl coated "S" hooks at each end
- 3000 lb. strap capacity/ 1500 lb. buckle capacity



THS60

- 5' long, 3/4" polypropylene web strap
- Reinforced grommet
- Spring loaded buckle at one end



SR6N1- 6 in 1 Ratchet Screwdriver

Sold in 12 pack display!

- Ratchet Action
- 3-Settings:
 - Forward
 - Manual
 - Reverse

- Bit Sizes
 - Slotted: 3/16" (5mm) and 1/4" (6mm)
 - Phillips: #1 and #2
 - Nut Driver: 1/4" and 5/16"



SAR21- 21 in 1 Angling Ratchet Screwdriver

Sold in 6 pack display!

- 21 Bit Sizes
- Multi-Position Angle
- Bit Storage

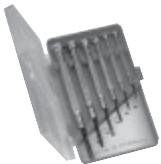

JS1 Jeweler's Screwdriver Set

Set of six assorted small-sized, swivel type screwdrivers.



UW1- Universal Wrench

Ranges in sizes from 1/4", 5/16", 11/32", and 3/8".



HK7 - Hex Key Wrench Set

Consists of seven 12" long hex wrenches: 5/64", 3/32", 1/8", 5/32", 3/16", 7/32" and 1/4".

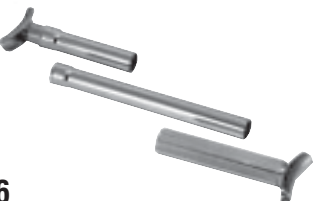

BJ10 - Belt-Jack Instant Belt Tightener

Designed to set belt tension and to help align pulleys on all belt driven units including blower motors, compressors, transmissions, and automotive components.

- Opens from 4 1/2" to 15" with extender
- Heavy duty 3/8-16 thread

BJ10PLUS - Belt-Jack Instant Belt Tightener

Same as BJ10 Plus an extra 6" extension

Terminals & Connectors

SUPCO Terminals, Cable Clamps, Grommets, Heat Shrink Tubing, Cable and Duct Ties are available in three convenient packages:

- The service pack is handy and low priced, ideal for small jobs.
- The BX (Box) which includes 50 or 100 pieces.
- The C Pack (Bag) which include 100 pieces.



SHS
Series

SHS Series Heat Shrink Tubing, Polyolefin 50% Shrink

PART NO.	DESCRIPTION	PKG QTY
SHS03	Heat Shrink Tubing 3/16" ID x 4"	8
SHS04	Heat Shrink Tubing 1/4" ID x 4"	7
SHS06	Heat Shrink Tubing 3/8" ID x 4"	6
SHS08	Heat Shrink Tubing 1/2" ID x 4"	5
SHS012	Heat Shrink Tubing 3/4" ID x 4"	4
SHS16	Heat Shrink Tubing 1" ID x 4"	3
SHSA1	Assorted 3/16, 1/4, 3/8" x 4"	7
SHSA2	Assorted 1/2, 3/4, 1" x 4"	4



SGV
Series

SGV Series Grommets, Vinyl (by panel hole size)

PART NO.	DESCRIPTION	PKG QTY
SGV04	Grommets 1/4" (.250)	18
SGV05	Grommets 5/16" (.3125)	15
SGV06	Grommets 3/8" (.375)	13
SGV07	Grommets 7/16" (.437)	12
SGV08	Grommets 1/2" (.500)	12
SGV10	Grommets 5/8" (.625)	7
SGV14	Grommets 7/8"	4
SGV16	Grommets 1"	4
SGVA1	Assorted Grommets - Small	15
SGVA2	Assorted Grommets - Large	5



SWC
Series

SWC Series Nylon Cable Clamps

PART NO.	DESCRIPTION	PKG QTY
SWC02	Nylon Cable Clamp 1/8" (.125)	40
SWC03	Nylon Cable Clamp 3/16" (.187)	40
SWC04	Nylon Cable Clamp 1/4" (.250)	35
SWC05	Nylon Cable Clamp 5/16" (.3125)	35
SWC06	Nylon Cable Clamp 3/8" (.375)	30
SWC08	Nylon Cable Clamp 1/2" (.500)	25
SWC110	Nylon Cable Clamp 5/8"	20
SWC112	Nylon Cable Clamp 3/4"	15
SWC116	Nylon Cable Clamp 1"	14
SWCA1	Cable Clamps, Assorted, 1/8" to 1"	26

Terminals & Connectors

Electrical Terminals



PART NO.	SIZE / DESCRIPTION	PKG QTY
Quick Disconnects - Insulated		
T1001	12-10 .250 (1/4") female tab	15
T1001C	12-10 .250 (1/4") female tab	100
T1002	16-14 .250 (1/4") female tab	20
T1002C	16-14 .250 (1/4") female tab	100
T2002	16-14 .187 (3/16") female tab	20
T2002C	16-14 .187 (3/16") female tab	100
T2004	22-18 .250 (1/4") female tab	20
T2004C	22-18 .250 (1/4") female tab	100



PART NO.	SIZE / DESCRIPTION	PKG QTY
Quick Disconnects - Insulated		
T1005	16-14 .250 (1/4") female fully insulated	10
T1105C	16-14 .250 (1/4") female fully insulated	100
T1007	18-22 .250 (1/4") female fully insulated	10
T1007C	18-22 .250 (1/4") female fully insulated	100
T1009	12-10 .250 (1/4") female fully insulated	10
T1009C	12-10 .250 (1/4") female fully insulated	100



PART NO.	SIZE / DESCRIPTION	PKG QTY
Quick Disconnects - Insulated		
T1021	.250 (1/4") double male tab	10
T1021C	.250 (1/4") double male tab	100



PART NO.	SIZE / DESCRIPTION	PKG QTY
Quick Disconnects - Insulated		
T1023	.250 (1/4") triple male tab	10
T1023C	.250 (1/4") triple male tab	100



PART NO.	SIZE / DESCRIPTION	PKG QTY
Quick Disconnects - Non Insulated		
T1102	16-14 .250 (1/4") female tab	20
T1102C	16-14 .250 (1/4") female tab	100
T1105	16-14 .187 (3/16") female tab	20
T1105C	16-14 .187 (3/16") female tab	100
T1107	22-18 .110 (7/64") female tab	20
T1107C	22-18 .110 (7/64") female tab	100
T2001	22-18 .110 (1/4") female tab	20
T2001C	22-18 .110 (1/4") female tab	100
Quick Disconnects - High Temp to 900°F		
T1111	16-14 .250 (1/4") female tab	20
T1111C	16-14 .250 (1/4") female tab	100
T1112	12-10 .250 (1/4") female tab	15
T1112C	12-10 .250 (1/4") female tab	100



PART NO.	SIZE / DESCRIPTION	PKG QTY
Quick Disconnects - Non Insulated		
T1108	16-14 .157 (5/32") bullet male	20
T1108C	16-14 .157 (5/32") bullet male	100



PART NO.	SIZE / DESCRIPTION	PKG QTY
Quick Disconnects - Insulated		
T1003	16-14 .250 (1/4") male tab	20
T1003C	16-14 .250 (1/4") male tab	100
T1004	12-10 .250 (1/4") male tab	15
T1004C	12-10 .250 (1/4") male tab	100
T2003	16-14 .187 (3/16") male tab	20
T2003C	16-14 .187 (3/16") male tab	100



PART NO.	SIZE / DESCRIPTION	PKG QTY
Quick Disconnects - Insulated		
T1106	16-14 .250 (1/4) male fully insulated	10
T1106C	16-14 .250 (1/4) male fully insulated	100
T1008	18-22 .250 (1/4) male fully insulated	10
T1008C	18-22 .250 (1/4) male fully insulated	100
T1010	12-10 .250 (1/4) male fully insulated	10
T1010C	12-10 .250 (1/4) male fully insulated	100



PART NO.	SIZE / DESCRIPTION	PKG QTY
Quick Disconnects - Insulated		
T1022	.250 (1/4) double male tab	10
T1022C	.250 (1/4) double male tab	100



PART NO.	SIZE / DESCRIPTION	PKG QTY
Quick Disconnects - Insulated		
T1027	16-14 .250 (1/4") male/female p.b.	10
T1027C	16-14 .250 (1/4") male/female p.b.	100
T1028	22-18 .250 (1/4") male/female p.b.	10
T1028C	22-18 .250 (1/4") male/female p.b.	100
T1029	12-10 .250 (1/4") male/female p.b.	10
T1029C	12-10 .250 (1/4") male/female p.b.	100



PART NO.	SIZE / DESCRIPTION	PKG QTY
Quick Disconnects - Non Insulated		
T1103	16-14 .250 (1/4") male tab	20
T1103C	16-14 .250 (1/4") male tab	100



PART NO.	SIZE / DESCRIPTION	PKG QTY
Quick Disconnects - Non Insulated		
T1104	16-14 .250 (1/4") flag	20
T1104C	16-14 .250 (1/4") flag	100
T1106	16-14 .187 (3/16") flag	20
T1106C	16-14 .187 (3/16") flag	100
Quick Disconnects - High Temp to 900 F		
T1113	16-14 .250 (1/4") female x 90 degree flag	20
T1113C	16-14 .250 (1/4") female x 90 degree flag	100



PART NO.	SIZE / DESCRIPTION	PKG QTY
Quick Disconnects - Non Insulated		
T1110	16-14 .157 (5/32") bullet female	20
T1110C	16-14 .157 (5/32") bullet female	100

Terminals & Connectors

Electrical Terminals



PART NO.	SIZE / DESCRIPTION	PKG QTY
Quick Disconnects - Non Insulated		
T1109	16-14 .250 (1/4") female tab w/insulation crimp	20
T1109C	16-14 .250 (1/4") female tab w/insulation crimp	100
T1120	16-14 .312 (5/16") female tab w/insulation crimp	10
T1120C	16-14 .312 (5/16") female tab w/insulation crimp	100
Quick Disconnects - High Temp to 900°F		
T2101	16-14 .250 (1/4") female with crimp	20
T2101C	16-14 .250 (1/4") female with crimp	100



PART NO.	SIZE / DESCRIPTION	PKG QTY
Quick Disconnects - Non Insulated		
T1127	16-14 .250 (1/4") male/female p.b.	10
T1127C	16-14 .250 (1/4") male/female p.b.	100



PART NO.	SIZE / DESCRIPTION	PKG QTY
Quick Disconnects - High Temp to 900°F		
T1114	12-10 .250 (1/4") female x 90 degree flag	20
T1114C	12-10 .250 (1/4") female x 90 degree flag	100



PART NO.	SIZE / DESCRIPTION	PKG QTY
Spade Flanged - Insulated		
T1042	22-18 #8 stud 11/64 I.D.	20
T1042C	22-18 #8 stud 11/64 I.D.	100
T1043	16-14 #8 stud 11/64 I.D.	20
T1043C	16-14 #8 stud 11/64 I.D.	100
T1044	16-14 #10 stud 13/64 I.D.	20
T1044C	16-14 #10 stud 13/64 I.D.	100
T1046	12-10 #10 stud 13/64 I.D.	15
T1046C	12-10 #10 stud 13/64 I.D.	100



PART NO.	SIZE / DESCRIPTION	PKG QTY
Spade - Insulated		
T1047	22-18 #8 stud 11/64 I.D.	20
T1047C	22-18 #8 stud 11/64 I.D.	100
T1048	16-14 #10 stud 13/64 I.D.	20
T1048C	16-14 #10 stud 13/64 I.D.	100
T1049	12-10 #10 stud 13/64 I.D.	15
T1049C	12-10 #10 stud 13/64 I.D.	100
T1050	12-10 #8 stud 11/64 I.D.	15
T1050C	12-10 #8 stud 11/64 I.D.	100



PART NO.	SIZE / DESCRIPTION	PKG QTY
Spade Flanged - Insulated		
T1141	22-18 #8 stud 11/64 I.D.	20
T1141C	22-18 #8 stud 11/64 I.D.	100
T1142	22-18 #10 stud 13/64 I.D.	20
T1142C	22-18 #10 stud 13/64 I.D.	100
T1143	16-14 #8 stud 11/64 I.D.	20
T1143C	16-14 #8 stud 11/64 I.D.	100
T1144	16-14 #10 stud 13/64 I.D.	20
T1144C	16-14 #10 stud 13/64 I.D.	100



PART NO.	SIZE / DESCRIPTION	PKG QTY
Rings - Insulated		
T1030	22-18 #6 stud 9/64 I.D.	10
T1030C	22-18 #6 stud 9/64 I.D.	100
T1031	22-18 #8 stud 11/64 I.D.	20
T1031C	22-18 #8 stud 11/64 I.D.	100
T1032	22-18 #10 stud 13/64 I.D.	20
T1032C	22-18 #10 stud 13/64 I.D.	100
T1033	16-14 #8 stud 11/64 I.D.	20
T1033C	16-14 #8 stud 11/64 I.D.	100
T1034	16-14 #10 stud 13/64 I.D.	20
T1034C	16-14 #10 stud 13/64 I.D.	100
T1035	16-14 1/4 stud 17/64 I.D.	15
T1035C	16-14 1/4 stud 17/64 I.D.	100
T1036	12-10 #8 stud 11/64 I.D.	15
T1036C	12-10 #8 stud 11/64 I.D.	100
T1037	12-10 #10 stud 13/64 I.D.	15
T1037C	12-10 #10 stud 13/64 I.D.	100
T1038	12-10 1/4 stud 17/64 I.D.	15
T1038C	12-10 1/4 stud 17/64 I.D.	100
T1039	16-14 3/8 stud 25/64 I.D.	15
T1039C	16-14 3/8 stud 25/64 I.D.	100
T1040	12-10 3/8 stud 25/64 I.D.	15
T1040C	12-10 3/8 stud 25/64 I.D.	100
T2033	16-14 #6 stud 9/64 I.D.	20
T2033C	16-14 #6 stud 9/64 I.D.	100
T2065	#8 1/4 stud 17/64 I.D.	15
T2065C	#8 1/4 stud 17/64 I.D.	100
T2066	#6 1/4 stud 17/64 I.D.	15
T2066C	#6 1/4 stud 17/64 I.D.	100



PART NO.	SIZE / DESCRIPTION	PKG QTY
Rings - Non Insulated		
T1131	22-18 #8 stud 11/64 I.D.	20
T1131C	22-18 #8 stud 11/64 I.D.	100
T1133	16-14 #8 stud 11/64 I.D.	20
T1133C	16-14 #8 stud 11/64 I.D.	100
T1134	16-14 #10 stud 11/64 I.D.	20
T1134C	16-14 #10 stud 11/64 I.D.	100
T1135	16-14 1/4 stud 17/64 I.D.	20
T1135C	16-14 1/4 stud 17/64 I.D.	100
T1136	12-10 #8 stud 11/64 I.D.	20
T1136C	12-10 #8 stud 11/64 I.D.	100
T1137	12-10 #10 stud 13/64 I.D.	20
T1137C	12-10 #10 stud 13/64 I.D.	100
T1138	12-10 1/4 stud 17/64 I.D.	15
T1138C	12-10 1/4 stud 17/64 I.D.	100
Rings - High Temp to 900°F		
T1115	16-14 #10 stud 13/64 I.D.	20
T1115C	16-14 #10 stud 13/64 I.D.	100
T1116	16-14 1/4 stud 17/64 I.D.	20
T1116C	16-14 1/4 stud 17/64 I.D.	100
T1117	12-10 #10 stud 13/64 I.D.	20
T1117C	12-10 #10 stud 13/64 I.D.	100
T1118	12-10 1/4 stud 17/64 I.D.	15
T1118C	12-10 1/4 stud 17/64 I.D.	100

Terminals & Connectors

Electrical Terminals



PART NO.	SIZE / DESCRIPTION	PKG QTY
Spade - Non Insulated		
T1145	22-18 #10 stud 13/64 I.D.	10
T1145C	22-18 #10 stud 13/64 I.D.	100
T1146	16-14 #10 stud 13/64 I.D.	10
T1146C	16-14 #10 stud 13/64 I.D.	100
T1147	10-12 #10 stud 13/64 I.D.	10
T1147C	10-12 #10 stud 13/64 I.D.	100
T1147-50	WIRE CNCTR, SM, GRAY	50



PART NO.	SIZE / DESCRIPTION	PKG QTY
Butt Connectors		
T1119	22-18 non insulated	20
T1119C	22-18 non insulated	100
T2067	#8 non insulated	20
T2067C	#8 non insulated	100
T2068	#6 non insulated	20
T2068C	#6 non insulated	100
T2111	16-14 non insulated	20
T2111C	16-14 non insulated	100
T2112	12-10 non insulated	15
T2112C	12-10 non insulated	100



PART NO.	SIZE / DESCRIPTION	PKG QTY
Line Tap Connector		
T1061	22-18 line tap connector	10
T1061C	22-18 line tap connector	100
T1062	16-14 line tap connector	10
T1062C	16-14 line tap connector	100
T1064	12-10 line tap connector	5
T1064C	12-10 line tap connector	100



PART NO.	SIZE / DESCRIPTION	PKG QTY
Connectors and Adapters		
T1122	.250 (1/4") 2 male x 1 female	10
T1122C	.250 (1/4") 2 male x 1 female	100



PART NO.	SIZE / DESCRIPTION	PKG QTY
Wire Connectors		
T1150	small blue wire nut with spring insert	20
T1150C	small blue wire nut with spring insert	100
T1151	medium orange wire nut with spring insert	15
T1151C	medium orange wire nut with spring insert	100
T1152	large yellow wire nut with spring insert	15
T1152C	large yellow wire nut with spring insert	100
T1153	extra large red wire nut with spring insert	10
T1153C	extra large red wire nut with spring insert	100
T1161	small yellow wire nut without insert	20
T1161C	small yellow wire nut without insert	100
T1162	medium white wire nut without insert	20
T1162C	medium white wire nut without insert	100
T1163	large white wire nut without insert	20
T1163C	large white wire nut without insert	100



PART NO.	SIZE / DESCRIPTION	PKG QTY
Butt Connectors		
T1051	22-18 insulated - red	20
T1051C	22-18 insulated - red	100
T1052	16-14 insulated - blue	20
T1052C	16-14 insulated - blue	100
T1053	12-10 insulated - yellow	15
T1053C	12-10 insulated - yellow	100



PART NO.	SIZE / DESCRIPTION	PKG QTY
Closed End Connectors		
T1056	22-18 insulated crimp type	20
T1056C	22-18 insulated crimp type	100
T1057	16-14 insulated crimp type	15
T1057C	16-14 insulated crimp type	100
T1058	12-10 insulated crimp type	15
T1058C	12-10 insulated crimp type	100
T1059	#8 insulated crimp type	15
T1059C	#8 insulated crimp type	100



PART NO.	SIZE / DESCRIPTION	PKG QTY
Line Tap with Disconnect		
T1065	18-14 line taps only	10
T1065C	18-14 line taps only	100



PART NO.	SIZE / DESCRIPTION	PKG QTY
Connectors and Adapters		
T1121	.250 (1/4") 2 male x 1 female	10
T1121C	.250 (1/4") 2 male x 1 female	100



PART NO.	SIZE / DESCRIPTION	PKG QTY
Connectors and Adapters		
T1123	.250 (1/4") x #10 stud	10
T1123C	.250 (1/4") x #10 stud	100



PART NO.	SIZE / DESCRIPTION	PKG QTY
Connectors and Adapters		
T1125	.250 (1/4") 2 male x 1 female	10
T1125C	.250 (1/4") 2 male x 1 female	100



PART NO.	SIZE / DESCRIPTION	PKG QTY
Connectors and Adapters		
T1124	.250 (1/4") female x #6 screw	10
T1124C	.250 (1/4") female x #6 screw	100



PART NO.	SIZE / DESCRIPTION	PKG QTY
Connectors and Adapters		
T1129	12-8 .250 (1/4") compressor terminal	10
T1129C	12-8 .250 (1/4") compressor terminal	100
T1130	16-14 .250 (1/4") compressor terminal	10
T1130C	16-14 .250 (1/4") compressor terminal	100

Terminals & Connectors

Electrical Terminals



PART NO.	SIZE / DESCRIPTION	PKG QTY
High Heat Porcelain Wire Connectors (Up To 1800 F)		
T1164	small #1 high heat porcelain wire nut 18- 14wire	15
T1164C	small #1 high heat porcelain wire nut 18 - 14 wire	100
T1165	small #3 high heat porcelain wire nut 12- 10 wire	15
T1165C	small #3 high heat porcelain wire nut 12 - 10 wire	100
T2070	small #1 high heat porcelain wire nut 8 - 10 wire	10
T2070C	small #1 high heat porcelain wire nut 8 - 10 wire	100



PART NO.	SIZE / DESCRIPTION	PKG QTY
Scotchlok Electrical Spring Connectors		
T1166	small yellow	15
T1166C	small yellow	100
T1167	medium red	10
T1167C	medium red	100
T1168	large gray	5
T1168L	large gray	50
T1169	extra large blue	5
T1169L	extra large blue	50



PART NO.	SIZE / DESCRIPTION	PKG QTY
Banana Plug		
T1179	includes black and red insulators	1 pair

PART NO.	SIZE / DESCRIPTION	PKG QTY
Heavy Duty Alligator Clips		
T1186	small includes black and red insulators	1 pair
T1187	medium includes black and red insulators	1 pair
T1188	large includes black and red insulators	1 pair

PART NO.	SIZE / DESCRIPTION	PKG QTY
Alligator Clips		
T1191	small standard clips	10
T1192	medium standard clips	5
T1193	medium for use with test leads	5

PART NO.	SIZE / DESCRIPTION	PKG QTY
Alligator Clips		
T1196	small includes black and red insulators	3 pair
T1197	medium includes black and red insulators	1 pair

Chemicals



12 per case

M44 Aerosol Lubricant & Metal Protectant

Specially created and perfected for Professional technicians and mechanics everywhere... and there is nothing like it in the world!

- Turns old tools into new ones
- Can be used on cars, trucks, bicycles, fishing gear, marine gear, electrical and electronic gear, machinery, appliances etc.

Applications

- Lubricates
- Prevents Rust and Corrosion
- Restores Moisture
- Restores Tools and Equipment



M098



M044

M098 Zoom Spout® Oiler

A paraffin base, non-gumming, high quality lubricating oil

- All-Purpose Lubricating Oil
- Flexible spout extends and retracts, adjusts to any "in-between" length
- Withstands high temperatures without breaking down
- Viscosity 92-99 @ 140°F

Applications

- All types of motors, blowers, oil burner bearings, linkages, appliance pumps, etc...
- Normal and High speed shaft bearings

Rust Buster® Solvent

Dissolves Rust

- Telescoping Pullout Spout
- Loosens rust in seconds
- No lingering odor
- Counter Display Case

PART NO.	BOTTLE SIZE	PACKAGING
M098	4 oz	12/Case
M044	4 oz	12/Case

SUPCO88 Oil Additive

Introduced in 1954 and valued worldwide, this super lubricant is a "must use" in repair and preventative maintenance programs.

- Compatible with all refrigeration oils
- Dissolves sludge buildup on bearing and valve surfaces
- Prevents binding of high speed compressors
- Prevents excess wear in motors and compressors

PART NO.	BOTTLE SIZE	PACKAGING
S8	8 OZ.	24/Ctn



Application Notes:

To Prevent Excess Wear on Expansion Valves and Capillaries Mix one part SUPCO88 to 9 parts refrigeration oil.

- Prevents excess wear on expansion valve needles and seats.
- Penetrates the pores of ALL moving metal parts of the expansion valve for constant lubrication.

Extend the Life of ALL Motors (i.e. for Blowers Air Conditioners)

- A few drops will help free a "frozen" or sticking motor shaft
- Mix 9 to one for regular bearing maintenance.
- Decreases "bearing to shaft" friction and sludge accumulation when mixed 9 to one.

More Efficiency for High Speed Compressors

- Increases the lubricating capability of mineral oils in high speed compressors.
- Used in new units to reduce current draw by reducing friction and preventing overloading.
- SUPCO88 can be left in the system permanently.

S0100/ST200

Slimeout®

Condensate Pan Conditioning Tablets

- Slimeout® tablets prevent plugging of the air conditioning condensate drip pans and drain lines
- Slimeout® does not release any chlorine or other noxious fumes
- Slimeout® eliminates odors
- Slimeout® easily solves problems

	PART NO.	PART NO.
	S0100	ST200
Description	Slime Out	Slime Tab
Tablets Jar	100	200
Tablet Size	35 grams	20 grams
Initial Application	2 tabs/3 tons	3 tabs/3 tons
Maintenance	2 per month	3 per month



* MSDS Sheets are available for all chemicals, visit www.supco.com

Chemicals



Leak Lock and Leak Lock GOLD with Teflon

A resin based soft setting brushable paste pipe joint compound resistant to all refrigerants, oils, water and most chemicals, liquids and gases.

- Use with pressures to 10,000 PSI to full vacuums.
- Temperature range -200°F to 400°F, (-93°C) to (204°C).
- It never hardens and it never becomes brittle.
- Ideal for joining all metals, plastics and other materials.
- Will stick to all clean surfaces.
- Will stick to all clean surfaces.
- Prevent vibration from loosening nuts, bolts, plugs and fittings.
- Non Toxic

PART NO.	SIZE	PKG
HS10001	1 1/3 oz Tube	12/Case
HS10004	4 oz Brush Top Plastic Jar	12/Case
HS10016	16 oz Brush Top Plastic Jar	12/Case
HS10128	1 Gallon Can	1

PART NO.	SIZE	PKG
HS11001	1 1/3 oz TUBE	12/Case
HS11004	4 oz Brush Top Plastic Jar	12/Case
HS11016	16 oz Brush Top Plastic Jar	12/Case
HS11128	1 Gallon Can	1

- GUARANTEES A PERFECT SEAL... UNDER ALL CONDITIONS



Red Epoxy

When you need a sealant you can count on. High Performance, Heat Cured, Two Part, Epoxy Kit

- Exhibits a Color Change When Cured (Turns Gold)
- May Be Cured With a Hot Air Gun or Open Flame in Minutes
- -100°F to 300°F, (-73°C) to (149°C)
- Working Pressure in Excess of 3000 PSI
- Tensile Strength: 6000 PSI
- Works on Vertical Surfaces
- Pressure Tested to 3000 PSI
- Simple, Quick Mixing & Application
- Oil, Gas, Fuel & Solvent Resistant
- No Rush, No Wait, You Control Curing Time
- Equipment is Serviceable Immediately
- Use on All Metals and Rigid Plastics
- HVAC & Refrigeration
- Plumbing & Appliances
- Automotive & Marine
- Petrochemical, Manufacturing
- Industrial, Commercial, Institutional

PART NO.	SIZE	PKG
HS12001	Kit Including 2 1/2 oz Tubes	12/Case



Solderlene

High Quality, Paste Type, Non-Acid Soldering Flux.

- Industrial strength wetting agents to promote solder flow
- For use with low and mid-temp. soft solders, both lead and lead-free
- Effective on all metals except aluminum and magnesium.
- Brush Top Plastic Jars
- Effective on all metals except aluminum and magnesium.

PART NO.	SIZE	PKG
HS30004	4 oz	12/Case
HS30016	16 oz	12/Case



Thawzone (New Formula)

The original liquid dehydrant, frees your frozen system in minutes. It seeks out moisture and chemically bonds to it.

- Enhanced moisture control in even the most advanced systems.
- Aids with oil return in low temperature systems.
- Compatible with all refrigerants and refrigeration lubricants.
- Helps prevent the formation of acid.
- No Methanol
- Environmentally Sound
- Safer
- Biodegradable, non-polluting
- Non-Poisonous

PART NO.	BOTTLE SIZE	PKG
HS17001	1 oz	24/Case
HS17004	4 oz	12/Case
HS17016	16 oz	6/Case

Add 1/8 fluid ounce (3.75 ml) of THAWZONE directly to the refrigerant of any system for every 1 lb. of refrigerant in the system.

*HIGH SIDE SYSTEM INJECTOR (part no. HSINJ001) IS RECOMMENDED FOR INTRODUCING THAWZONE INTO AN OPERATING SYSTEM.



Spiro Lite UV Bulb

120 Volt Florescent UV Light Source
For Your Light Trouble

PART NO.	PKG
HSUVB001	1

Chemicals

Highside System Injector

Use for introducing any liquid into the low side of a charged hermetic system.

- Entirely reusable
- Constructed of rugged aluminum for long life
- Designed for use with any standard manifold gauge and requires no extra valves or fittings
- Drip proof, no spill design takes the mess out of maintenance
- Helps prevent the venting of refrigerants into the atmosphere.
- Prevents the introduction of air into an operating system.
- It can be used on sealed operating systems to avoid shutdowns.
- Use with Trace, Trace 2, Thawzone and Acid Neutralizer
- Compatible with all refrigerants



PART NO.	PKG
HSINJ001	1

Gas Leak Detector Low Temp

Leaks appear as large strong bubbles which cling to the surface and are fluorescent under a black light.

- Non-freezing
- Fluorescent
- Rated to -30°F (-34°C)
- Non-toxic
- Non-hazardous
- Bubble-type gas leak detector

Use On:

- Hot and cold piping
- Natural Gas
- Most Gases
- Air
- All Refrigerants

PART NO.	SIZE	TYPE	PKG
LOW TEMP			
HS22008	8 oz	Plastic Bottle w/Dauber	24/Case
HS22032	32 oz	Trigger Sprayer Bottle	12/Case
HS22128	1 Gal.	Plastic Bottle	6/Case
MID TEMP			
HS23008	8 oz	Plastic bottle w/Dauber	24/Case
HS23032	32 oz	Trigger Sprayer Bottle	12/Case
HS23128	1 Gal.	Plastic Bottle	6/Case

Gas Leak Detector Mid Temp

Trace2

A red penetrant dye in a polyolester base that is completely compatible with all refrigerants and lubricants, old and new. Use to locate the hardest to find leaks under the toughest conditions in low light or dark areas.

- Leaks show as bright red stains
- For refrigeration and hydraulic systems
- Florescent with any ultraviolet light source
- Non-volatile and will not sludge or deposit gum
- Clearly visible, even through ice and frost
- Locates leaks exactly, no false positives

Trace

A red penetrant dye in a mineral oil base that is completely harmless to refrigeration, air conditioning and hydraulic equipment.

Hydro Trace

Locate hard-to-find leaks in any closed system containing water and/or antifreeze compounds such as Propylene Glycol and Ethylene Glycol. When added to a system leaks are easily visible as bright red stains under normal lighting conditions and as a bright orange glow when exposed to an ultraviolet light source.

Applications Include:

- Refrigeration
- Hydronics
- Automotive
- Process Cooling
- Chemically Inert
- Will not harm equipment or seals

WITH SUPERBRITE UV TRACER		
PART NO.	SIZE	PKG
TRACE2		
HS21004	4 oz Plastic Bottle	12/Case
HS21016	16 oz Plastic Bottle	6/Case
HS21128	1 Gallon Can	4/Case
TRACE		
HS20004	4 oz Plastic Bottle	12/Case
HS20016	16 oz Plastic Bottle	6/Case
HS20128	1 Gallon Can	4/Case
HYDRO TRACE		
HS26004	4 oz Plastic Bottle	12/Case
HS16016	16 oz Plastic Bottle	6/Case
HS26128	1 Gallon Can	4/Case

Trace2 and Trace are the easiest and least expensive way to locate leaks in an operating system and are for use in systems where the lubricants travel with refrigerants.

* MSDS Sheets are available for all chemicals, visit www.supco.com



Chemicals



Trax

Bubble-type liquid leak detector formulated to produce long lasting bubbles under 'job-site' conditions.

- Clear
- No Cleanup
- Environmentally Friendly
- Evaporates Leaving No Residue
- Temp Range: 27°F (-3°C) to 200°F (93°C).
- Non-Toxic
- Does Not Pit Surfaces
- Detects Leaks as Small as 1 Micron
- Oxygen Compatible

Meets the performance requirements of Military specifications: MIL 25567 Type I A, B & C.

PART NO.	SIZE	TYPE	PKG
HS24000	1-1/3 oz	Squeeze Bottle	24/Case
HS24010	10 oz	Squeeze Bottle w/ Extensible Spout	12/Case
HS24128	1 GAL.	Bottle	6/Case



Dye Wash

Removes any type of leak detecting dye from equipment and Pipe surfaces to prevent false readings during future and follow-up leak detection.

- Non-Toxic
- Environmentally Friendly
- Non-Corrosive
- Easy To Use

PART NO.	SIZE	PKG
HS51032	32 oz Spray Bottle	12/Case
HS51128	1 GAL. Pastic Bottle(Refill)	6/Case



The Acid Test - 4 COMPLETE TESTS IN EACH KIT

For detecting the presence and formation of acid in air conditioning and refrigeration systems.

- Easy to use
- No Complicated Charts
- Results in Seconds
- Very Inexpensive
- Non-Toxic
- Non-Hazardous
- Accurate Results
- Eliminates Guess Work
- Safe Formula
- Biodegradable
- Non-Flammable
- For use with all Refrigerants

PART NO.	PKG
HS16001	12/Case

Simple to Understand Color Change Indicators!

BLUE OR VIOLET . No Acid Present

GREEN Moderately Acidic

YELLOW Acidic



Acid Neutralizer

The BEST Acid Treatment available neutralizes residual acid caused by compressor burnout.

The Cure for Acid Problems.

- Works Fast
- Circulates Quickly
- Compatible with ALL Lubricants
- Safe, Will Not Harm System Components
- No Complicated Charts
- No Solids or Solid Residuals
- Compatible with ALL Refrigerants
- Neutralizes Acid in Recovery Equipment
- Easy to Use
- Can Prevent Compressor Burnout

PART NO.	SIZE	PKG
HS18004	4 oz.	12/Case

A vital part of any preventative maintenance program.



Super Flush AC/R Internal System Cleaner

Neutralizes and Removes Acid Caused By Compressor Burnout

- Biodegradable
- Easy to Use
- Cleans in a Single Treatment
- Compatible with All Refrigerants and Refrigeration Oils
- Does Not Contain Halogenated Solvents
- Cleaning Agent for all A/C and Refrigeration Parts
- Environmentally Safe
- Non-Flammable
- Saves Time and Money
- One Treatment Cleans and Removes:
 - Sludge
 - Gum
 - Debris
 - Moisture
 - Carbon Deposits
 - Tar
 - Grease
 - Organic Acids
 - Soot
 - Mineral Acids

Use:

- Before a system retrofit
- After a compressor burnout
- Recovery, Recycling and Reclamation Equipment
- On automotive (Remove immediately)

PART NO.	SIZE	PKG
HS55032	32 oz Plastic Bottle	12/Case
HS55128	1 Gal. Plastic Bottle	6/Case

* MSDS Sheets are available for all chemicals, visit www.supco.com

Chemicals

Coil Tamer Products Made For The Professionals



PINK STUFF

Heavy Duty, Foaming, Acid Based Concentrated Liquid Coil Cleaner Foaming Action Pushes Dirt Out of Coils to be Rinsed Away.

- Non Flammable
- Easy to Use
- Non Oily
- Biodegradable

Cleans and Brightens:

- Condenser Coils
- Evaporator Coils
- Equipment Surfaces

Effective On:

- Heavy Oxidation
- Oily Dirt
- Grease
- Mold
- Algae
- Oils
- Lint
- Mildew

Easily Applied Using Standard Low Pressure Sprayer

PART NO.	CONTAINER	PKG
HS58128	1 Gal. Plastic Bottle	4/Case



GREEN STUFF

Concentrated Alkaline Based Liquid Coil Cleaner

- Non Flammable
- Fast Acting
- Non Oily
- Biodegradable
- Brightens

For Heavy Duty Cleaning and Degreasing of:

- Condenser Coils
- Evaporator Coils
- Fins
- Permanent Filters
- Equipment Surfaces
- Electronic Cells

Effective On:

- Grease
- Dirt
- Dust
- Lint
- Mildew
- Algae
- Tar
- Oil
- Nicotine
- Mold

Self Rinsing on Evaporator Coils and is Easily Applied with a Low Pressure Sprayer.

PART NO.	CONTAINER	PKG
HS59128	1 Gal. Plastic Bottle	4/Case



EV Coil Max

Powerful Coil Cleaner in Powder Form to Avoid Dangerous Liquid Spills.

- Environmentally Friendly
- Virtually Odorless
- Easy to Use and Clean Up
- Lowers Freight Costs
- Extra Long Shelf Life *(13 to 1)
- Its powder form is a safer alternative to liquid coil cleaners
- No Acidic Residue
- Fast Acting
- Prevents Corrosion
- Less Storage Space *(16 to 1)

*16 oz equals 1 gallon 6:1 (9 lbs or 144oz weight) solution

PART NO.	CONTAINER	PKG
HS56011	16 oz Plastic Jar	12/Case



HL Coil Brite Coil Cleaner

Acid Based, Powder Coil Cleaner with Controlled Foaming Action

- Clean the Toughest Coils
- Mild Odor
- Indefinite Shelf Life
- Nonflammable
- Lowers Freight Costs *(13 To 1)
- Less Storage Space*(16 to 1)
- Easy to Use
- No Dangerous Liquid Spills
- Makes Old Coils Look New
- Easy Rinse for Quick Cleaning

*14oz equals 1 gallon 6:1 (9 lbs or 144oz weight) solution

PART NO.	CONTAINER	PKG
HS57014	14 oz Plastic Bottle	12/Case



Coil Blaster Solvent

Solvent Based High Pressure Aerosol Coil Cleaner

- Pleasantly Scented
- Nonflammable
- Degreases
- Fast Drying
- Nonconductive
- Safe To Use On Equipment While Running
- Basting Aerosol Nozzle
- No Residue
- Easy To Use
- No Cleanup

Use On:

- Evaporator Coils
- Electrical Equipment
- Condenser Coils
- Automotive Parts
- All HVAC/R Equipment
- Electrical Components

Effective On:

- Dirt
- Grime
- Grease
- Oil

PART NO.	CONTAINER	PKG
HS58520	18 oz Aerosol Can	12/Case

Chemicals



HD Jet Foamer Coil Cleaner

Heavy Duty Foaming Coil Cleaner in an aerosol can

- Convenient
- Pleasant Scent
- Environmentally Friendly
- No Ozone Depleaters
- 360
- No Chlorinated Solvents
- Easy to Store
- Water Based
- Nonflammable
- Corrosion Inhibitors
- Spray Nozzle

Quickly and Easily Liquifies:

- Dirt
- Oil
- Deposits
- Grease
- Residues

Use On:

- Evaporator Coils
- Condenser Coils

Will Not Harm Plastics, Metals or Surrounding Equipment

PART NO.	SIZE	PACKAGING
HS59520	19 oz Aerosol Can	12/Case



ICEMAX Nickel Safe Ice Machine Cleaner

High Performance Ice Machine Cleaner in a Powder avoids dangerous and messy spills that can damage your facility, vehicles and destroy other valuable inventory. Prevents liquid spills that can attract unnecessary regulatory attention.

- Inhibits Formation of Scale
- Prevents Corrosion
- Environmentally Friendly
- Will Not Separate or Chemically Change Over Time
- Indefinite Shelf Life (When Kept Sealed)
- Saves Freight Costs
- Maximum Scale Removing Power
- No Acidic Residue
- Makes 1 Gallon of Concentrated Cleaner

PART NO.	SIZE	PACKAGING
HS50004	4.4 oz	12/Case



Filter Fan & Vent Cleaner

Heavy duty cleaner specifically formulated for the heating, ventilation, air-conditioning and refrigeration industry.

- Biodegradable
- Non-Corrosive
- Easy to Use
- Environmentally Friendly
- Non-Toxic
- Safe & Effective

Removes:

- Dust
- Grease
- Tar Deposits
- Dirt
- Oil

Use On:

- Electronic Cells
- Permanent Air Filters
- All Vents & Vent Surfaces
- Equipment Surfaces
- Most Air Cleaning Equipment
- Permanent Pre-Filters
- Fan Blades, Plastic & Metal

PART NO.	SIZE	PACKAGING
HS52032	32oz Plastic Spray Bottle	12/Case
HS52128	1 Gal. Plastic Refill	6/Case



Mainsqueeze

Industrial strength citrus hand cleaner

- Safe
- Moisturizes and Conditions
- Water Rinse or can be Wiped Dry
- Biodegradable
- Refreshing and Pleasant Scent

Twice the cleaning power of any other hand cleaner.

Citrus Terpenes and other natural emollients to cut through the tough, hard to remove elements.

- Dirt
- Grime
- Resins
- Paints
- Grease
- Odors
- Inks
- Rubber, Gasket and Tile Cements

Available with or without pumice in 8 oz. pocket squeeze tube or 1 gallon portable container with pump dispenser.

PART NO.	SIZE	PACKAGING
HS40008	8 oz Tube w/Pumice	12/Case
HS40128	1 Gal. Dispenser w/Pumice	4/Case
HS41008	8 oz Tube w/o Pumice	12/Case
HS41128	1 Gal. Dispenser w/o Pumice	4/Case



CDC Anti-Clog

Condensate Drainpan Conditioner

Laboratory proven to kill 99% of Legionnaire's Disease bacteria and a broad spectrum of harmful bacteria including those causing the common cold and other respiratory ailments.

- EPA Registered
- Improved Chemical Formulation
- Water activated timed-release
- 3 to 6 months, 24 hours/day service
- Works in equipment of all sizes (Available in 2 Sizes)
- Filter material meters biocide for consistent chemical release
- Sealed, tamper proof housing prevents skin contact w/ biocide
- Designed not to clog drain hole
- Can be placed vertically or horizontally
- Ph neutralizers help protect drainpan against corrosion
- 40% more high efficiency biocide (by weight)

Use CDC ANTI-CLOG* wherever there is Air Conditioning and Refrigeration Equipment

PART NO.	SIZE	PACKAGING
HS52105	Units up to 5 Tons	24/Case
HS52115	Units up to 15 Tons	12/Case

* MSDS Sheets are available for all chemicals, visit www.supco.com

Chemicals



ICE BLOCK Heat Transfer & Anti-Freeze

Propylene Glycol based anti-freeze and heat transfer fluid capable of providing pipe burst protection to temperatures as low as -100°F (-73°C). All ingredients are generally regarded as safe by the FDA, making ICE BLOCK the recommended anti-freeze protection where there is possible contact with potable water sources.

- Non-Toxic
- Chemically Stable - Will Not Separate
- Maximum Heat Transfer
- Protects Pipes and Other System Components From Freeze Damage
- Safe and Easy to Use
- Lubricates As It Works
- Safe For Use Where Contact with Potable Water is Possible
- Maximum Corrosion Protection
- Will Not Leave Deposits

Applications Include:

- Refrigeration Systems
- Chilled Water Systems
- Coil Defrosting
- Ice Making Machines
- Water Based Heat Extraction System
- Snow Melting Systems
- Winterization of Any Water Based Systems
- Hydronic Heating Systems
- Solar Heating & Hot Water Systems
- Cooling Systems & Chillers
- Immersion Freezing
- Air Hydronic, Heat Pumps & Furnaces.
- Process Cooling
- Ground Water Coupled Heat Pumps
- Cooling Towers
- Industrial Heat Transfer Systems
- Fire Hydrant & Sprinkler System

PART NO.	SIZE	PACKAGING
HS15128	1 Gallon	6/Case



KLEEN-AIR Odor Absorber

- Simply open the spout to absorb and remove all kinds of odors.
- One 8 ounce bottle works for 1 year in a 9' x 12' room

PART NO.	SIZE	PACKAGING
KA12	8 oz.	12/Case
KA36	8 oz.	36/Case*

*KA36 case is a counter display 13" x 13" x 15"



Epoxi Putty

- Cures Wet or Dry - will cure underwater
- Mixes like clay hardens like steel
- After curing, can be sanded, drilled, tapped, machined, sawn, or painted.
- Initial set in 10 to 15 minutes, hard set 1 hour, with full cure in 24 hours.
- Temperature range -65°F to +250°F
- Works on glass, wood, plastic, fiberglass, tile, concrete, and many more.

PART NO.	DESCRIPTION	QUANTITY PER CARTON	REPLACES GEM NO.
9900H	Tan Epoxy Putty 4" blocks	24	—
9900K	Tan Epoxy Putty 8" blocks	24	—
9901K	Tan Quick Epoxy Putty 4" blocks	24	—
9904H	White Epoxy Putty 4" blocks	24	EP8002 Half-size
9904K	White Epoxy Putty 8" blocks	24	EP8002
9906H	Aluminum Epoxy Putty 4" blocks	24	EP8001 Half-size
9906K	Aluminum Epoxy Putty 8" blocks	24	EP8001
9915K	White Fast Set Epoxy Paste	24	—

Reference No.	Supco No.	Page
0042166	SGR402	145
0047067	SGR402	145
0054068	SGR405	145
0054156	SL90	55
0054159	SM365	10 - 11
0054160	SLT55	55
0054450	RIM116	20 to 27
0054498	RIM115	20 to 27
0054628	SH416	53 & 54
0055501	SL10010	56, 58 to 60
0055546	SM339	10 - 11
0056504	RIM900	20 to 27
0056599	IMM8366	20 to 27
0056605	RIM900	20 to 27
0056606	RIM900	20 to 27
00-6103	ES16301	82, 92, & 118
0061567	SGR405	145
0061568	SGR405	145
00-6163	ES16301	82, 92, & 118
00620365	SM316	9 & 11
00620901	SL50	55
00620962	SM316	9 & 11
00621008	SL50	55
00621891	SM316	9 & 11
00622462	SM316	9 & 11
00622609	SL50	55
00622852	SM316	9 & 11
00623048	SM316	9 & 11
00623319	SM316	9 & 11
00624974	SFR100	37, 40 to 44
00625094	SM316	9 & 11
00627250	SFR85	37, 40 to 44
00627286	SM316	9 & 11
00627289	SM316	9 & 11
00627293	SM316	9 & 11
00627316	SL50	55
00627414	SM333	9 & 11
0062766	SGR408	145
00627878	SL50	55
00627879	SM332	9 & 11
00628046	SL50	55
00628530	SM316	9 & 11
00628531	SM316	9 & 11
00629464	SL50	55
00629966	SM316	9 & 11
00629968	SM316	9 & 11
0063148	SGR408	145
0064395	SGR408	145
0064446	SGR408	145
0064671	SGR408	145
0068013	SGR405	145
0068014	SGR405	145
0068015	SGR405	145
0068016	SGR405	145
0068017	SGR405	145
0068018	SGR405	145
0068019	SGR405	145
0068025	SGR408	145
0068026	SGR408	145
0068043	SGR408	145
0069737	SGR405	145
0070245	SGR405	145
0070369	SGR405	145
0070957	SGR405	145
0072202	SGR405	145
0072203	SGR405	145
0086689	SGR405	145
0086690	SGR405	145
0087699	SGR408	145
0089333	SGR405	145
0089336	RR117	129
0091160	SGR405	145
01124534	SFR85	37, 40 to 44
01135288	SL50	55
01135442	SM332	9 & 11
01135914	SM332	9 & 11
01136916	SL50	55
01137820	SM333	9 & 11
01137863	SFR100	37, 40 to 44
01138694	SFR100	37, 40 to 44

Reference No.	Supco No.	Page
015494	LP349	81
0309145	SGR408	145
0309150	SGR405	145
0309151	SGR405	145
0309154	SGR405	145
0309155	SGR403	145
0309157	SGR408	145
0309157SV	SGR408	145
0309158	SGR408	145
0309158SV	SGR408	145
0309159	SGR408	145
0311155	RIM900	20 to 27
0311729	SL5844	24
0312471	SL10010	56, 58 to 60
0312578	RIM900	20 to 27
0312738	RIM900	20 to 27
0312739	RIM900	20 to 27
0312740	RIM900	20 to 27
039282-07	SAM32	39 to 44
045563-01	SM335	9 & 11
047195-01	RIM900	20 to 27
06540457	SL50	55
06565294	SL50	55
06582737	SL50	55
06585546	SL50	55
06595156	SL50	55
06595294	SL50	55
06595363	SL50	55
06598507	SM316	9 & 11
06599014	SM316	9 & 11
06599015	SM316	9 & 11
06599388	SM316	9 & 11
06599389	SM316	9 & 11
06599538	SL2690	56, 58 to 60
072T699F01	SGR403	145
07511940	SL50	55
07512366	SL50	55
07512516	SFR75	37, 40 to 44
07513645	SL50	55
07515434	SM316	9 & 11
07516267	SL50	55
07516378	SL50	55
07516457	SM316	9 & 11
07516628	SFR75	37, 40 to 44
07516629	SFR75	37, 40 to 44
07516659	SL50	55
07541121	SFR85	37, 40 to 44
07544342	SFR75	37, 40 to 44
07544495	SM316	9 & 11
07546170	SL50	55
07546181	SM316	9 & 11
07546735	SM316	9 & 11
08000036	SM336	9 & 11
08000061	SH439	51 & 54
08000068	GC161	1 - 3
08000073	SL2690	56, 58 to 60
08000131	SGI47	37, 40 to 44
08000290	SGI46	37, 40 to 44
08000745	SH419	51 & 54
08000816	SWC21	37, 40 to 44
08000817	SWC20	37, 40 to 44
08002726	GC161	1 - 3
08003635	GC161	1 - 3
08003827	SL50	55
08004171	SH419	51 & 54
08004176	SM336	9 & 11
08007095	GC161	1 - 3
08007104	SGI47	37, 40 to 44
08007115	SGI46	37, 40 to 44
08007122	SWC21	37, 40 to 44
08007123	SWC20	37, 40 to 44
08007988	SGR403	145
08009420	SGR412	145
08009564	SH439	51 & 54
08009733	SWC41	37, 40 to 44
08009735	SWC12	37, 40 to 44
08009754	SH457	51 & 54
08010243	SWC58	37, 40 to 44
08010244	SWC55	37, 40 to 44
08010249	SWC49	37, 40 to 44

Reference No.	Supco No.	Page
08010755	SGI47	37, 40 to 44
08011166	SL2690	56, 58 to 60
08011454	SGR409	145
08011455	SGR412	145
08013883	SGR412	145
08014146	SL2691	56, 58 to 60
08015544	SWC12	37, 40 to 44
08015762	GC161	1 - 3
08015763	GC161	1 - 3
08016625	SWC58	37, 40 to 44
08016626	SWC55	37, 40 to 44
08017217	GC161	1 - 3
08017218	GC161	1 - 3
08017430	SWC49	37, 40 to 44
08017445	GC161	1 - 3
08017487	SWC12	37, 40 to 44
08017563	SL2690	56, 58 to 60
08-04-051	SGR412	145
08067970	SGR407	145
08067971	SGR412	145
08068021	SGR409	145
097083	DP160	130 to 134
099911	DP160	130 to 134
0A4298	LP348	81
0I00500399	SGR402	145
0I00504199	SGR411	145
0I00505099	SGR411	145
10064	SGR412	145
10129301	SPA12930	6
10220	SGR409	145
10222	SGR411	145
10233	SGR412	145
103079002	SL79002	57 to 60
103079005	SL79005	57 to 60
10359709	SAM63	38, 40 to 44
10359709Q	SAM63	38, 40 to 44
10442402	SLT55	55
10442407	SLT55	55
10442411	SL2691	56, 58 to 60
10530703	SPM10530	6
10544001	SL50	55
10544002	SL2690	56, 58 to 60
10544003	SL50	55
10544005	SL50	55
10549201	RIM900	20 to 27
10563705	RIM900	20 to 27
10563705Q	RIM900	20 to 27
10563707	RIM900	20 to 27
10563708	RIM900	20 to 27
105877	SH224	49
106.8114	RIM900	20 to 27
106.81503	RIM2000	20 to 27
106.8340	RIM2000	20 to 27
106.8390	RIM2000	20 to 27
106.8550	RIM900	20 to 27
10-8259	SGR403	145
10872	SGR409	145
10-9220	SGR402	145
1100435	SL3084	57 to 60
1100436	SL3084	57 to 60
1100473	SM343	10 - 11
1100474	SM343	10 - 11
1100945	SM328	10 - 11
1100992	SM343	10 - 11
1103841	SL2697	57 to 60
1103842	SL2697	57 to 60
1104905	SCS98	39 to 44
1105164	SH447	53 & 54
1105298	RIM313	20 to 27
1105608	SM343	10 - 11
1105609	SM343	10 - 11
1105693	GC182	1 - 3
1105694	GC182	1 - 3
1106173	SCS115	39 to 44
1106174	SCS75	39 to 44
1106175	SCS115	39 to 44
1106176	SCS75	39 to 44
1106177	SCS102	39 to 44
1106179	SCS102	39 to 44
1106890	SL2697	57 to 60

Reference No.	Supco No.	Page
1107331	GC185	1 - 3
1107638	SCS46	39 to 44
1107711	SM328	10 - 11
1107715	SM328	10 - 11
1108001	GC185	1 - 3
1108002	GC185	1 - 3
1108003	GC185	1 - 3
1108008	GC182	1 - 3
1108010	GC182	1 - 3
1108106	RIM316	20 to 27
1108111	SM328	10 - 11
1108154	RIM316	20 to 27
1108164	SL3084	57 to 60
1108165	SL3084	57 to 60
1108182	SL2697	57 to 60
1108199	SL3084	57 to 60
1108574	SL3084	57 to 60
1108575	SL3084	57 to 60
1108614	GC185	1 - 3
1109185	SCS115	39 to 44
1109186	SCS75	39 to 44
1109187	SCS115	39 to 44
1109188	SCS75	39 to 44
1110545	SL3084	57 to 60
1110546	SL3084	57 to 60
1110569	SCS98	39 to 44
1110648	SCS105	39 to 44
1110649	SCS116	39 to 44
1110658	SCS79	39 to 44
1110659	SCS97	39 to 44
1110702A	RIM115	20 to 27
1110762	SL3084	57 to 60
1110763	SL3084	57 to 60
11-1111	LB275	120 to 124
1113044	SL3084	57 to 60
1113405	SL3084	57 to 60
1114185	RIM313	20 to 27
1114209	RIM316	20 to 27
1114238	GC182	1 - 3
1114241	GC182	1 - 3
1115076	GC185	1 - 3
1115192	SL7500	57 to 60
1115193	SL7500	57 to 60
1115314	SCS105	39 to 44
1115315	SCS79	39 to 44
1115456	SL3084	57 to 60
1115457	SL3084	57 to 60
1115682	SCS99	39 to 44
1116734	SCS99	39 to 44
1118191	SCS116	39 to 44
1118192	SCS97	39 to 44
1118554	RIM313	20 to 27
1118555	RIM900	20 to 27
1118688	SL3084	57 to 60
1118690	SL3084	57 to 60
1118691	SL3084	57 to 60
1118715	SM328	10 - 11
1118746	RIM313	20 to 27
1118766	RIM316	20 to 27
1118824	SL3084	57 to 60
1118825	SL7500	57 to 60
1118826	SL3084	57 to 60
1121294	SL7500	57 to 60
1121295	SL7500	57 to 60
1122826	SCS115	39 to 44
1122827	SCS75	39 to 44
1122829	SCS102	39 to 44
1123212	GC182	1 - 3
1123213	GC182	1 - 3
1123393	GC182	1 - 3
1123394	GC182	1 - 3
1124971	SCS116	39 to 44
1124972	SCS97	39 to 44
1125889	SCS99	39 to 44
1125924	SCS103	39 to 44
1125926	SCS79	39 to 44
1125927	SCS105	39 to 44
1125928	SCS97	39 to 44
1125929	SCS116	39 to 44
1127256	SCS103	39 to 44

Reference No.	Supco No.	Page
1127307	SCS116	39 to 44
1127308	SCS97	39 to 44
1127309	SCS116	39 to 44
1127310	SCS97	39 to 44
1127599	RIM316	20 to 27
1127661	SL3084	57 to 60
1127753	SL3084	57 to 60
1127754	SL3084	57 to 60
1127771	SL3084	57 to 60
1127805	SL7500	57 to 60
1127867	SL7500	57 to 60
1127868	SL7500	57 to 60
1127884	GC182	1 - 3
1128059	SCS115	39 to 44
1128060	SCS102	39 to 44
1128061	SCS98	39 to 44
1129266	SCS105	39 to 44
1129267	SCS79	39 to 44
1129303	RIM316	20 to 27
1129306	RIM316	20 to 27
1129312	RIM313	20 to 27
1129313	RIM313	20 to 27
1129314	RIM900	20 to 27
1129316	RIM316	20 to 27
1129318	RIM316	20 to 27
1129617	GC182	1 - 3
1135288	SL55	55
1135693	SL90	55
11511	SGR403	145
116136	SL50	55
116139	SL50	55
116310	RIM900	20 to 27
1165801A	RIM2000	20 to 27
1165807A	RIM115	20 to 27
1170101A	RIM117	20 to 27
12001027	SH327	52 & 54
12001187	ES16807	78, 83 & 119
12001294	RIM900	20 to 27
12001302	RIM116	20 to 27
12001349	DE382WR	94, 96, 98, 105 & 109
12001435	LB294	120 to 124
12001541	DE693	108
12001586	LP1586	78, 83, 85, & 90
12001772	LP2533	83
12001788	LB294	120 to 124
12002040	LB788	120 to 124
12002533	LP2533	83
12017802	SL50	55
12017804	SL50	55
12017806	SL50	55
12017816	SL50	55
12017823	SL50	55
12111213	LB237	120 to 124
12112425	LB127	120 to 124
123931	LP920	81, 84, & 90
12400035	SGR412	145
12500010	RIM900	20 to 27
12500011	RIM900	20 to 27
12500012	RIM900	20 to 27
12500048	RIM2000	20 to 27
12550101Q	SAM54	38, 40 to 44
12550109Q	SAM55	38, 40 to 44
12550111Q	SAM56	38, 40 to 44
12550112Q	SAM57	38, 40 to 44
12550115Q	SAM58	38, 40 to 44
12550116Q	SAM59	38, 40 to 44
126693	SH222	49
1301601A	RIM2000	20 to 27
131130700	LB216	120 to 124
131154800	DE790	96 & 100
131180500	25M01A-100 110	92 to
131180700	25M01A-100	92 to 110
131208500	GVW151	78, 80, 81, 83, 87

Reference No.	Supco No.	Page
131234000	LB117	120 to 124
131276300	LB295	120 to 124
131298300	L14515W	94, 97 & 116
131298400	L14515W	94, 97 & 116
131475300	DE339	95
131553800	LB216	120 to 124
131654	LB210	120 to 124
131686100	LB157	120 to 124
131825900	DE727	95
131862900	DE788	78
1327001PA	RIM2000	20 to 27
133171	LB113	120 to 124
134048800	L13515W	94, 97 & 116
134049200	SSD8	78, 88, & 89
134051000	LB295	120 to 124
134120900	SLF222VA	94, 97 & 114
134161100	LB117	120 to 124
134163400	LB216	120 to 124
134163500	LB298	120 to 124
134192000	SDE358	95, 100, 101
13439400	SDE358	95, 100, 101
134394900	SDE358	95, 100, 101
134503600	LB216	120 to 124
134503900	LB298	120 to 124
136102	LB202	120 to 124
138833	SH223	49
139318	LB111	120 to 124
140254	SH226	49
140801	LB210	120 to 124
141297	LB210	120 to 124
143056	LB260	120 to 124
143151	SH224	49
144667	LB157	120 to 124
145221	LB260	120 to 124
145371	LB157	120 to 124
1469	SGR404	145
1482224	SGR412	145
1482225	SGR412	145
148270	LB216	120 to 124
148271	LB298	120 to 124
1500202	LB113	120 to 124
150747	SH221	49
15100	ES15100	141
15-10-136	SGR412	145
15102	ES15102	141
15-10-312	SGR412	145
15-10-312-01	SGR412	145
15105	ES15105	141
15106	ES15106	141
15108	ES15108	141
15200	ES15200	141
15201	ES15201	141
15202	ES15202	141
15204	ES15204	141
15205	ES15205	141
15211	ES15211	141
15400	ES15400	141
15501	ES15501	141
15502	ES15502	118
15601	ES15601	118
15801	ES15801	118
15803	ES15803	118
15805	ES15805	118
15806	ES15806	118
15807	ES15807	93 & 118
15810	ES15810	118
15811	ES15811	118
15813	ES15813	118
15901	ES15901	118
15902	ES15902	118
15903	ES15903	118
15905	ES15905	118
15907	ES15907	93, 112, & 118
16009	SGR412	145
16100	ES16100	76, 81, 111, 112 & 118
16192	LB160	120 to 124
16200	ES16200	78, 92, 106, & 118
16300	ES16300	73, 76, 82, 118

Reference No.	Supco No.	Page
16301	ES16301	82, 92, & 118
16358	LB160	120 to 124
16400	ES16400	85, 110 & 118
16600	ES16600	76, 81, 107 & 119
16700	ES16700	100
16802	ES16802	24, 73, 119
16806	ES16806	83, 93, 95, 100, 101, 108, 119
16807	ES16807	78, 83 & 119
17001	ML45	55
17003	ML50	55
17005	ML55	55
17007	ML60	55
17009	ML70	55
17011	ML80	55
17013	ML90	55
17558	LB270	120 to 124
1790263	RS101	144
17952	SGR403	145
18001005	C25D	28
180-2A190	SGR412	145
180-2A216	SGR410	145
180-2A251	SGR411	145
180-2A300	SGR412	145
180-2A303	SGR412	145
1805E115	DP122	130 to 134
18100	ES18100	45
18200	ES18200	45
18300	ES18300	45
1841N17	DP112	130 to 134
1841N18	DP113	130 to 134
1841N29	DP112	130 to 134
1841N30	DP113	130 to 134
18500	ES18500	45
18503	SPP5	62
18504	SPP6	62
18505	SPP8E	62
18600	ES18600	45
18601	SGR412	145
18700	ES18700	45
187-1076	SGR403	145
187C144H01	SL70	55
18801	ES18801	45
18802	ES18802	45
18803	ES18803	45
18804	ES18804	45
18805	ES18805	45
18806	ES18806	45
18807	ES18807	45
18809	ES18809	45
18810	ES18810	45
18811	ES18811	45
18812	ES18812	45
18813	ES18813	45
18814	ES18814	45
18815	ES18815	45
18816	ES18816	45
18817	ES18817	45
2000528	SL3084	57 to 60
200063	LB302	120 to 124
2001	SU2001	36, 37, 40 to 44
20-01-500	SGR412	145
2002	SU2002	36, 37, 40 to 44
2003	SU2003	36, 37, 40 to 44
2004	SU2004	36, 37, 40 to 44
200937P	LP127	78, 83
201112	LP920	81, 84, & 90
20129	LP515	78
201537	LP347	81
201809	ES16600	76, 81, 107 & 119
20186	LB137	120 to 124
202203	LP117	81
204012	LP340	81
204013	LP341	81
204415	ES16100	76, 81, 111, 112 & 118
204660	LP663	81
205000	LP921	81

Reference No.	Supco No.	Page
205416	ES16301	82, 92, & 118
205613	GVW151	78, 80, 81, 83, 87
205614	GVW151	78, 80, 81, 83, 87
206154	LP585	82
20640IL60	SL5844	24
20640L44510-842	SLT55	55
20640L44510-860	SLT55	55
20641L1137-596	SL5022	24
206680	LP666	82
207166	ES7166	82, 83
21001137	ES16807	78, 83 & 119
21001478	LB132	120 to 124
21001732	LP123	83
21001873	LP128	83
21001906	LP123	83
21002240	LP128	83
211124	LB125	120 to 124
2-11124/25	LB127	120 to 124
211125	LB126	120 to 124
211451	LB151	120 to 124
211726	LP923	82
212989	LP956	82
213013	LP665	82
213015	LP580	82
21352320	LB132	120 to 124
21353662	LB132	120 to 124
21365	LP953	84
21366	LP331	84
2147024	SCS103	39 to 44
214765	LP992	82
2148043	SCS115	39 to 44
2148044	SCS102	39 to 44
2148270	SCS105	39 to 44
2148271	SCS79	39 to 44
2149299	SM399	10 - 11
2149641	SL7503	57 to 60
2149643	SL7503	57 to 60
2149849	SL6155	57 to 60
2150117	SCS75	39 to 44
215019104	SWC49	37, 40 to 44
2151215	SL3084	57 to 60
215213300	SM378	9 & 11
215235	LP668	82
215314700	SM336	9 & 11
215348100	SM378	9 & 11
215348200	SM336	9 & 11
215360800	SM336	9 & 11
2154419	SM343	10 - 11
2154544	SL3084	57 to 60
215464000	SM336	9 & 11
215464100	SM336	9 & 11
2154945	OL4	32
2154974	GC182	1 - 3
2154977	SM343	10 - 11
2155184	RIM900	20 to 27
2155185	RIM316	20 to 27
2155186	RIM316	20 to 27
2155187	RIM316	20 to 27
2155188	RIM316	20 to 27
2155468	RIM2000	20 to 27
2155469	RIM316	20 to 27
2155469A	RIM2000	20 to 27
2155468	RIM2000	20 to 27
2155469	RIM316	20 to 27
2155469A	RIM2000	20 to 27
215608901	SWC55	37, 40 to 44
215608911	SWC20	37, 40 to 44
215608931	SWC55	37, 40 to 44
215608941	SWC20	37, 40 to 44
215608961	SWC55	37, 40 to 44
215608971	SWC20	37, 40 to 44
2157229	GC182	1 - 3
2157231	GC182	1 - 3
215732401	SWC58	37, 40 to 44
215732402	SWC41	37, 40 to 44
215732403	SWC12	37, 40 to 44
215732411	SWC21	37, 40 to 44
215732412	SWC26	37, 40 to 44

Reference No.	Supco No.	Page
215732461	SWC58	37, 40 to 44
215732462	SWC41	37, 40 to 44
215732463	SWC12	37, 40 to 44
215776701	SWC55	37, 40 to 44
215776711	SWC20	37, 40 to 44
215776761	SWC55	37, 40 to 44
215846602	SC959	8
215846604	A1401ADO	8
216016	LP991	82
2160436	SCS103	39 to 44
2160438	SCS103	39 to 44
2160883	SCS103	39 to 44
216100110	OL1	32
2161331	SL6155	57 to 60
216201	LP581	82
2162293	GC182	1 - 3
2162404	SM399	10 - 11
2162425	GC182	1 - 3
2162427	GC182	1 - 3
2162642	SCS112	39 to 44
2163766	SM345	10 - 11
2163894	SL7503	57 to 60
2166013	SM346	10 - 11
216744400	SC801	7
2169116	SM343	10 - 11
2169143	SM343	10 - 11
2169485	SM346	10 - 11
217101	LB160	120 to 124
2171718	RIM400	20 to 27
2171811	RIM2000	20 to 27
2172694	SL7503	57 to 60
2176066	SL6155	57 to 60
2176298	SM345	10 - 11
2176748	GC182	1 - 3
2176941	SL7490	57 to 60
2177232	SCS103	39 to 44
218226700	RIM116	20 to 27
2182380	SL7503	57 to 60
2183072	SL7503	57 to 60
2183073	SL7490	57 to 60
218322200	SM336	9 & 11
2183400	SC804	7
2183448	SM345	10 - 11
2183833	SM345	10 - 11
218394100	SM378	9 & 11
218661700	SM336	9 & 11
218699501	RIM116	20 to 27
218710901	WF284	30
218710902	WF284	30
218713500	RIM116	20 to 27
218717805	WF284	30
218718402	SM378	9 & 11
218718403	SM336	9 & 11
218730603	SWC26	37, 40 to 44
218730604	SWC41	37, 40 to 44
218730609	SWC22	37, 40 to 44
218730610	SWC12	37, 40 to 44
218734400	RIM400	20 to 27
218736300	RIM115	20 to 27
2188303	SM399	10 - 11
2188404	SCS105	39 to 44
2188405	SCS79	39 to 44
2188406	SCS79	39 to 44
218876901	SL2690	56, 58 to 60
218878700	SM336	9 & 11
218878701	SM336	9 & 11
218878901	SM336	9 & 11
218916201	SL2690	56, 58 to 60
21899501	RIM116	20 to 27
2191888	SCS112	39 to 44
2196155	SL6155	57 to 60
2198597	RIM900	20 to 27
22001274	GVV151	78, 80, 81, 83, 87
22001682	ES682	83 & 119
22001978	LP2533	83
22002040	LB788	120 to 124
22002044	ES16806	83, 93, 95, 100, 101, 108 & 119
22002162	ES7166	82 - 83

Reference No.	Supco No.	Page
22002313	LB788	120 to 124
22002709	LB297	120 to 124
22003483	LB297	120 to 124
22003898	LP2533	83
2200546	SM345	10 - 11
220-1191	SGR412	145
2204	SU2204	35, 38, 40 to 44
2205138	SM345	10 - 11
2213	SU2213	35, 38, 40 to 44
22204012	LP340	81
2221677	SL7503	57 to 60
223240-1010	SGR412	145
223C3381G001	SGR412	145
223C3381G002	SGR412	145
223C3381G003	SGR412	145
223C3381G004	SGR412	145
223C3381G005	SGR412	145
227203	LB276	120 to 124
229769	DP113	130 to 134
2301	SU2301	36, 37, 40 to 44
230131	DE901	110
2302	SU2302	36, 37, 40 to 44
2303	SU2303	36, 37, 40 to 44
2304	SU2304	36, 37, 40 to 44
230652	ES16400	85, 110 & 118
235030	SGR403	145
23540	ES16200	78, 92, 106, & 118
237555	LB270	120 to 124
23759	LB143	120 to 124
237683	LB271	120 to 124
238739	LB271	120 to 124
239087	DE737	110
239173	LP173	85, 110 & 119
239453	ES16400	85, 110 & 118
239477	DE418	110 & 112
24001096	LB306	120 to 124
2-4012	LP340	81
2-4013	LP341	81
240352401	RIM116	20 to 27
240352403	RIM116	20 to 27
240352407	RIM116	20 to 27
240352409	RIM116	20 to 27
240352412	RIM116	20 to 27
240389101	WF284	30
24157-12	SAD38	38
24A34-1	Q101	67
24A34-14	Q107	67
24A34-2	Q102	67
24A34-3	Q103	67
24A34-4	Q104	67
24A34-5	Q105	67
24A34-6	Q106	67
2-5000	LP921	81
25001812	C25D	28
25002012	C25	28
2564D44H05	SL6792	56, 58 to 60
26230-2	SL55	55
26230-3	SL55	55
26230-9	SL45	55
26289-1	SL60	55
2655D44H04	SL6792	56, 58 to 60
2656D44H02	SL60	55
2656D44H03	SL60	55
2656D44H04	SL60	55
2656D44H05	SL60	55
2656D44H09	SL50	55
27001006	LB302	120 to 124
27001007	LB175	120 to 124
27001036	LP127	78, 83
27001233	LP127	78, 83
27155	LB140	120 to 124
27246	LB142	120 to 124
27268-1	SL60	55
27612	ES16807	78, 83 & 119
27791-1	SL60	55
27791-2	SL60	55
27791-4	SL60	55
27791-5	SL70	55
27791-6	SL60	55

Reference No.	Supco No.	Page
27791-7	SL60	55
27791-8	SL70	55
279044	SET117	97, 104 & 109
279046	SET117	97, 104 & 109
279048	SET103	103, 104 & 109
279050	SET118	109
279052	SET144	97 & 109
279054	SET149	109
279080	SET119	94 & 109
279137	DE381	93, 95 & 110
279173	LP173	85, 110 & 119
279264	DE735	110
279347	LP210	85, 101, 110 & 119
279408	DE768	110
279455	DE180	110
279570	DE902M	96, 99, 107 & 110
279598	DE195	110
279711	DE601	112
279769	SET184	109
279782	LP210	85, 101, 110 & 119
279787	SM279787	111
279816	SET194	109
279827	SM279827	111
279834	DE382WR	94, 96, 98, 105 & 109
279838	DE838	102 & 111
27987000	SM554	16
279888	25M01A-10198	to 110
279923	25M01A-10092	to 110
28-08-00200-001	SH270	50 & 54
28-08-00200-004	SH271	50 & 54
281348	DP112	130 to 134
285134	LP731	85
285206	LP988	85
285285	LP951	85
285317	LP115	85
285320	LP1586	78, 83, 85, & 90
285573	DP131	130 to 134
285671	ES671	85 & 119
285672	LP925	86
285746	LP285	86
285748	LP254	86
285751	LP285	86
285753	LP337	86
285770	LP338	84
285770D	LP338D	84
285811	LP285	86
285834	LP5834	86 & 90
285852	LP337HD	86
287371	LB271	120 to 124
28808	LB142	120 to 124
29425-3	SM339	10 - 11
296326	LB271	120 to 124
29708	SM335	9 & 11
29708-1	SM335	9 & 11
297P3	LP1586	78, 83, 85, & 90
29815-1	SH311	52 & 54
298422	LB271	120 to 124
298800	ES16400	85, 110 & 118
299992	SM279827	111
2K11124/25	LB127	120 to 124
2NT01L0959	SLT55	55
300105	DW439	76
3001224	SM336	9 & 11
3001304	SWC55	37, 40 to 44
3001317	SWC58	37, 40 to 44
3001336	GC161	1 - 3
3001362	SH419	51 & 54
3001363	SL2690	56, 58 to 60
3001398	SWC58	37, 40 to 44
3001399	SWC55	37, 40 to 44
3001416	SWC12	37, 40 to 44
3001421	SM336	9 & 11
3001453	GC161	1 - 3
3001466	SH439	51 & 54
3001517	SWC41	37, 40 to 44
3001525	GC161	1 - 3
3001529	SH457	51 & 54
3002-01	SPN1111AD7	
300259	SGR403	145
3002-801	SC801	7
3002-802	SC802	7
3002-803	SC803	7
3002-804	SC804	7
3002-806	SC806	7
3002-807	SC807	7
3002-901	SPF17633	6
3002-903	SPL1111W7	
3002-904	SP931WP	7
3002-905	SPJ1111AM7	
3002-906	SPF1111F7	
3004909	LB210	120 to 124
300608	SET111	103 & 104
3006112	GC161	1 - 3
3007540	SL2690	56, 58 to 60
300858	SET103	103, 104 & 109
300859	SET109	91, 103 & 104
301007	SET163	97, 103 & 104
301451	SET175	103, 104 & 109
3015075	SL2690	56, 58 to 60
3015195	SL2691	56, 58 to 60
301552	SET106	103 & 104
3015865	SL55	55
3016211	SGR409	145
301634	SET121	91, 97, 103, 104
301636	SET108	103 & 104
3016814	SL2690	56, 58 to 60
301724	L180-40	94, 97, 103, 104 & 117
3017373	SWC41	37, 40 to 44
3017815	GC161	1 - 3
3018238	SWC12	37, 40 to 44
3018555	SWC22	37, 40 to 44
3018792	SWC22	37, 40 to 44
3018981	SGR412	145
301933	FL150	#N/A
301948	L200	91, 94, 103, 104 & 117
301952	SET109	91, 103 & 104
301978	SHF160	103 & 115
301979	LD170	97, 103 & 117
302288	ES16200	78, 92, 106, 118
302838	SET109	91, 103 & 104
302850	SET145	103 & 104
3030-116	GC116	1 - 3

Reference No.	Supco No.	Page
3030-11F	GC116	1 - 3
3030-140	GC140	1 - 3
3030-14J	GC140	1 - 3
3030-16J	GC161	1 - 3
3030-178	GC178	1 - 3
3030-17H	GC178	1 - 3
303030	LD130	91, 94, 97, 103 & 104
3030-305	GC175	1 - 3
3030-314	GC183	1 - 3
3030-31D	GC183	1 - 3
303035	SET163	97, 103 & 104
303036	SET145	103 & 104
303037	SHF130	104 & 115
303225	LD135	91, 94, 97, 103, 117
303318	ES16200	78, 92, 106, & 118
303373	DE693	108
303376	DE350	#N/A
303377	DE353	93, 96, 101, 106, 111
303391	SET163	97, 103 & 104
303392	SET105	91, 94, 97, 103 & 104
303394	SET108	103 & 104
303395	SET175	103, 104 & 109
303396	SET104	94, 97, 104 & 109
303404	DE138	106
303618	SET121	91, 97, 103 & 104
303705	DE405	106
303773	SET105	91, 94, 97, 103 & 104
303797	SET117	97, 104 & 109
303806	DE602	106
303836	DE602	106
303919	ES16100	76, 81, 111, 112 & 118
304474	SET117	97, 104 & 109
304475	SET105	91, 94, 97, 103 & 104
304970	DE364	#N/A
305169	SET174	104
305837K	DP112	130 to 134
305839K	DP113	130 to 134
305864	SET106	103 & 104
305865	SET145	103 & 104
305953	LD130	91, 94, 97, 103 & 104
306060	SET111	103 & 104
306084	25M01A-10092	to 110
306105	DE382BWR	93, 94, 95, 98, 105, 109
306106	DE382AWR	93, 94, 95, 98, 105, 109
306176	25M01A-10198	to 110
306436	DE902	93, 96, 99, & 106
306508	DE747	106
306604	SET408	105
306608	SET111	103 & 104
306910	L15515W	116
306911	L15515W	116
306965	SET175	103, 104 & 109
306966	FL200	94, 97, 103, 104 & 116
306967	L15515W	116
307249	L15515W	116
307250	LD15525W	104 & 117
307458	RK458	149
307473	SET409	105
308036	LD14520W	104 & 117
3081180	SC802	7
308345	25M01A-10198	to 110
308541	25M01A-10198	to 110
308542	25M01A-10198	to 110
308648B	DP142	130 to 134
308648K	DP133	130 to 134
308649B	DP143	130 to 134
308649K	DP134	130 to 134
309157	SGR408	145
309157SV	SGR408	145
309158	SGR408	145

Reference No.	Supco No.	Page
309158SV	SGR408	145
31-001	ML45	55
31001026	LB276	120 to 124
31001043	DE343	108
31001088	L14520W	91, 104, 109 & 116
31001096	DE692	108
31001192	L14520W	91, 104, 109 & 116
31001469	DE786	108
31001470	DE785	108
31-002	ML50	55
31-003	ML55	55
31-004	ML60	55
31-005	ML70	55
31-006	ML80	55
31-007	ML90	55
31-0309145-04-0	SGR408	145
31-0309146-04-0	SGR408	145
31-0309150-04-0	SGR405	145
31-0309157-04-0	SGR408	145
31-0309157-SV-0	SGR408	145
31-0309158-04-0	SGR408	145
31-0309158-SV-0	SGR408	145
31-0309159-04-0	SGR408	145
31-0311618-04-0	SGR408	145
311012	LB230	120 to 124
3-11012/13	LB237	120 to 124
311013	LB231	120 to 124
311534	DE739	106
311618	SGR409	145
311946	DE326	106
311946C	DE326	106
312512	LB232	120 to 124
312544	LB235	120 to 124
312913	DE602	106
312948	DE687	106
312959	LB234	120 to 124
3131090	SGR412	145
3131300	SGR412	145
3131872	SGR409	145
313328	LB236	120 to 124
313382	RR382	129
313538	DE327	107
313584	SGR403	145
314774	LB234	120 to 124
3149653	SET175	103, 104 & 109
3149983	RK362	149
3149984	RK362	149
3149985	RK362	149
3149986	RK362	149
3149987	RK362	149
3149988	RK362	149
3150244	DP131	130 to 134
3150245	DP132	130 to 134
3150246	DP133	130 to 134
3150247	DP134	130 to 134
3-15-032-0	FB718G	18
31531589	LB276	120 to 124
316030600	SGR412	145
316030700	SGR409	145
3161099	LB202	120 to 124
3161152	LB117	120 to 124
316119301	SGR412	145
316119302	SGR409	145
316126400	SGR412	145
3161423	LB155	120 to 124
3169204	DP333	130 to 134
3169205	DP334	130 to 134
316T013S01	SGR403	145
316T017P01	SGR403	145
316T017P02	SGR403	145
316T017P03	SGR403	145
316T017P05	SGR403	145
316T017P06	SGR403	145
316T017P07	SGR403	145
316T017S01	SGR403	145
316T023P01	SGR409	145
316T023P02	SGR409	145
316T023P03	SGR407	145
316T023P04	SGR409	145
316T023P05	SGR409	145

Reference No.	Supco No.	Page
316T023P06	SGR409	145
316T023P07	SGR407	145
316T023P08	SGR409	145
316T023P10	SGR407	145
316T023P12	SGR407	145
316T023S01	SGR407	145
316T030P01	SGR403	145
316T031P01	SGR412	145
316T031P02	SGR412	145
316T031P03	SGR412	145
318138500	DP147	130 to 134
318138501	DP146	130 to 134
318177710	SGR412	145
318177720	SGR412	145
318177730	SGR412	145
3186491	SGR412	145
31939801	SGR408	145
31939901	SGR408	145
3196447	SGR403	145
319887	SGR403	145
31991701	SGR412	145
3200258	SWC20	37, 40 to 44
3200261	SWC26	37, 40 to 44
3200274	SWC49	37, 40 to 44
3200508	SGR410	145
3200799	SWC49	37, 40 to 44
3200810	GC161	1 - 3
3201208	DE790	96 & 100
3202115	SM334	9 & 11
3202296	SL50	55
3203018	LB295	120 to 124
3203706	SGR412	145
3204267	FL260	94, 97, & 116
3204307	L135	91, 94, 97 & 117
3204314	LB260	120 to 124
3204418	LB157	120 to 124
3204422	DE788	78
3204718	SGR412	145
3204873	IC102	32
3204985	SL2690	56, 58 to 60
3205156	SGR412	145
3205549	DW116	73
3206301	GA31	25
3206306	IMM6306	25
3206319	SL6319	24
3206322	SL6322	24
321342	SGR403	145
3261151	LB150	120 to 124
3261153	LB154	120 to 124
3261155	LB151	120 to 124
32701	SPP5	62
32702	SPP6	62
32707	SPP7S	62
32708	SPP8E	62
327263	SGR403	145
32741	RCO410	31
327617	SGR403	145
32781	RCO810	31
3280323	LB117	120 to 124
3280326	LB113	120 to 124
3281154	LB260	120 to 124
3283287	LB298	120 to 124
329314	LD135	91, 94, 97, 103 & 117
33001003	DE529	108
33001167	DE532	108
33001171	DE533	108
33001506	ES16806	83, 93, 95, 100, 101, 108 & 119
33001508	ES16806	83, 93, 95, 100, 101, 108 & 119
33001762	SET407	105
33001777	LB279	120 to 124
33001808	DE534	108
33002535	LB279	120 to 124
33002970	DE533	108
330031	RR110	129
33008	SL45	55
33009	SL50	55

Reference No.	Supco No.	Page
33010	SL55	55
33011	SL60	55
33012	SL70	55
33013	SL243	55
33014	SL245	55
33015	SL247	55
330190	RK190	149
33020	SL80	55
33021	SL90	55
33031	SL5844	24
33035	SL5022	24
33-0388	LB131	120 to 124
330685	DP113	130 to 134
330686	DP112	130 to 134
330689	SGR403	145
330719	SET402	109
33-100	SM550	16
33-101	SM551	16
33-103	SM552	16
33-104	SM553	16
33-105	SM554	16
33-106	SM555	16
332299	DP125	130 to 134
33232	Q105	67
33233	Q106	67
33-2374N	GVW151	78, 80, 81, 83, 87
33241	Q101	67
33242	Q102	67
33244	Q103	67
33245	Q104	67
33248	Q107	67
33265	Q113	67
33-3382	ES16301	82, 92, & 118
33-42166-04-0	SGR402	145
33445	ES16301	82, 92, & 118
3348552	HP421	87
3349985	LP986	87
3352287	SM3352287	88
3355806	LP901	88
3357027	GNBA	80, 87
33-6104	LB131	120 to 124
33-61567-04-0	SGR405	145
33-61568-04-0	SGR405	145
3362624	LP225	88
33-62766-04-0	SGR408	145
33-63148-04-0	SGR408	145
3363394	LP116	88
33-6343	LB131	120 to 124
3363892	LP121	88
3364290	LP226	88
3364291	LP228	88
3364293	LP234	88
33-64395-04-0	SGR408	145
33-64446-04-0	SGR408	145
33-64671-04-0	SGR408	145
336650	SGR407	145
3367910	DW132	76
33-68013-04-0	SGR405	145
33-68014-04-0	SGR405	145
33-68015-04-0	SGR405	145
33-68017-04-0	SGR405	145
33-68018-04-0	SGR405	145
33-68019-04-0	SGR405	145
33-68025-04-0	SGR408	145
33-68026-04-0	SGR408	145
33-68043-04-0	SGR408	145
33-69737-04-0	SGR405	145
337019	LB274	120 to 124
33-70245-04-0	SGR405	145
33-70369-04-0	SGR405	145
33-70957-04-0	SGR405	145
33-72202-04-0	SGR405	145
33-72203-04-0	SGR405	145
337263	SGR403	145
337388	LB275	120 to 124
337942	LB271	120 to 124
33832	Q105	67
33833	Q106	67
33841	Q101	67

Reference No.	Supco No.	Page	Reference No.	Supco No.	Page	Reference No.	Supco No.	Page	Reference No.	Supco No.	Page
33842	Q102	67	34197	SH301	51 & 54	3713880	LB279	120 to 124	40051502	LB254	120 to 124
33844	Q103	67	34198	SH302	51 & 54	37820	LB175	120 to 124	40053601	LB302	120 to 124
33845	Q104	67	342601	DE905	99 & 112	3772129009	SL90	55	40053602	LB175	120 to 124
33848	Q107	67	344395	SET153	91, 97 & 109	3772129011	SL90	55	40053606	LB302	120 to 124
33-86689-04-0	SGR405	145	34484000	SM556	16	3772129022	SL60	55	40053607	LB175	120 to 124
3387134	L15525W	91, 109 & 116	345007	DP166	130 to 134	3772129023	SL60	55	40111201	LB254	120 to 124
3387138	L15510W	91, 103, 104, & 109	345008	DP167	130 to 134	3772129024	SL90	55	41-202	SGR409	145
3387185	SM279787	111	345473	LB279	120 to 124	3772129025	SL70	55	41-203	SGR410	145
3387477	DE7477	113	345675	LB278	120 to 124	3772129026	SL60	55	41-204	SGR411	145
3387610	LB254	120 to 124	347226	DE418	110 & 112	3772129049	SL90	55	41-205	SGR412	145
33-87699-04-0	SGR408	145	34885	SP931WP	7	3772143206	SL90	55	41-206	SGR408	145
3387747	DE7477	113	348855	DE524	113	3772143266	SL55	55	41-207	SGR407	145
3388237	SM279787	111	34886	SPF17633	6	3773129134	SLT55	55	4157446	SGR403	145
3388238	SM279787	111	34890	SPF1111F	7	3773129312	SLT55	55	4157689	SGR401	145
338906	DE353	93, 96, 101, & 111	34891	SPL1111W	7	377312967	SLT55	55	4157865	DP110	130 to 134
33-89333-04-0	SGR405	145	34892	SPJ1111AM	7	38174	LB302	120 to 124	4157866	DP111	130 to 134
3389628	LB276	120 to 124	34895	SPF17633	6	383727	LP633	87	4159914	ES16300	73, 76, 82, 118
3389720	LB254	120 to 124	349241	DE702	100 & 112	386P3	LP1586	78, 83, 85, & 90	4160011	ES16100	76, 81, 111, 112 & 118
3389728	LB254	120 to 124	349241T	DE702T	112	389248	SM389248	87	4160496	DW303	76
3390291	SET198	109	349533	LB279	120 to 124	3937010	DE339	95	4161629	DW304	76
33-9064	ES16807	78, 83 & 119	349639	DE525	112	3949247	ES247	88 & 119	4162322	DW610	76
33-91160-04-0	SGR405	145	34963P	GVW151	78, 80, 81, 83, & 87	3977767	SET185	109	4163781	SGR407	145
3391381	SET201	109	35004	OV32	33	3977767 Kit	SET197	109	4164936	SGR401	145
3391890	SM279787	111	35007	OV34	33 - 34	3ART5C167	GC195	1 - 3	4165441	SGR401	145
3391891	SM279787	111	35009	OV36	33 - 34	3ART5C197	GC190	1 - 3	4168768	SGR401	145
3391893	SM279787	111	35010	OV36	33 - 34	3ART5C212	GC195	1 - 3	4170062	SGR401	145
3392519	SET401	97 & 109	35011	OV38	33 - 34	3ART5LP5	GC185	1 - 3	4172010	DW606	76
3392665	LB276	120 to 124	35012	OV40	33 - 34	3ART5MA16	GC161	1 - 3	4200520	RIM900	20 to 27
339392	DE522	111	35014	OV38	33 - 34	3ART5VAA14	GC192	1 - 3	4200521	RIM900	20 to 27
3393999	LB254	120 to 124	35015	OV40	33 - 34	3ART5VC131	GC188	1 - 3	4200522	RIM900	20 to 27
3394651	LB276	120 to 124	35016	OV48	33 - 34	3ART5VC163	GC188	1 - 3	4201760	RIM943	20 to 27
3394652	LB278	120 to 124	35017	OV44	33 - 34	3ART5VC44	GC183	1 - 3	4210317	RIM500	20 to 27
3394653	LB278	120 to 124	35018	OV46	33 - 34	3ART5VC84	GC140	1 - 3	4210579	SC801	7
339489	DE686	99, 111 & 112	35-0186	LB131	120 to 124	3ART5VC96	GC140	1 - 3	4211173	RIM500	20 to 27
339491	DE904	111	35019	OV48	33 - 34	3ART5VC99	GC140	1 - 3	4212244	DP112	130 to 134
3395654	SM279787	111	35020	OV50	33	3ART5VCH35	GC175	1 - 3	4212245	DP113	130 to 134
3395656	SM279787	111	350365	LP113	86	3ART5VG1	GC161	1 - 3	422311606	Q111	67
33-9787	LB131	120 to 124	350367	LP114	86	3ART5VG10	GC161	1 - 3	422311607	Q112	67
3398128	L14520W	91, 104, 109 & 116	35-0425	LB131	120 to 124	3ART5VG15	GC161	1 - 3	422311608	Q110	67
339908	SET119	94 & 109	35-0465	LB131	120 to 124	3ART5VG16	GC161	1 - 3	43002	43309	68
3399506	DE685	100 & 113	350484	LP210	85, 101, 110 & 119	3ART5VG21	GC161	1 - 3	43006	43359	68
3399844	LB276	120 to 124	350920	LP319	86	3ART5VG3	GC161	1 - 3	43007	43004	68
3399849	SET410	109	35-2320	LB132	120 to 124	3ART5VG4	GC161	1 - 3	43011	43320	68
3403140	SET104	94, 97, 104 & 109	352967	LB161	120 to 124	3ART5VG6	GC161	1 - 3	43018	43005	68
34111	SH221	49	35-3662	LB132	120 to 124	3ART5VG8	GC161	1 - 3	43-0283	LB131	120 to 124
34112	SH222	49	355519	LP218	86 & 112	3ART5VH39	GC177	1 - 3	43053	43054	69
34113	SH223	49	355T429S01	SGR403	145	3ART5VN11	GC182	1 - 3	430540	ES16200	78, 92, 106, & 118
34114	SH224	49	355T429S02	SGR403	145	3ART6A11	GC116	1 - 3	430542	ES16806	83, 93, 95, 100, 101, 108 & 119
34115	SH225	49	355T429S03	SGR403	145	3ART6A14	GC116	1 - 3	43103	43154	70
34116	SH226	49	356403	LB280	120 to 124	3ART6A22	GC116	1 - 3	431177	L340	91, 97, 104 & 117
34117	SH227	49	356500	LP219	86	3ART6A25	GC116	1 - 3	43153	43154	70
34118	SH228	49	356934	LP630	86	3ART6A32	GC116	1 - 3	43157	43154	70
34119	SH229	49	358276	GVW151	78, 80, 81, 83, & 87	3ART6A9	GC116	1 - 3	4317943	RIM500	20 to 27
34120	SH230	48	358336	LP318	87	3ART6MA4	GC116	1 - 3	4318001	SM343	10 - 11
34121	SH231	48	359-176	SGR402	145	3ART6VA32	GC116	1 - 3	4318002	SM328	10 - 11
34122	SH232	48	359-181	SGR402	145	3ART6VA4	GC116	1 - 3	4318083	IC100	32
34123	SH233	48	359-183	SGR412	145	3ART6VA3	GC116	1 - 3	4318297	SP697	61
34124	SH234	48	359-184	SGR412	145	3ART6VC43	GC116	1 - 3	4319392	LB278	120 to 124
34125	SH235	48	359-195	SGR412	145	3ART6VC44	GC116	1 - 3	4320913	SGR412	145
34126	SH236	48	359-196	SGR412	145	3ART6VC45	GC116	1 - 3	43218	SH416	53 & 54
34127	SH237	48	359-199	SGR411	145	3ART6VC54	GC116	1 - 3	4322910	SGR403	145
34128	SH238	48	359-201	SGR402	145	3ART8VC1	GC116	1 - 3	4324056	DP125W	130 to 134
34129	SH239	48	359-202	SGR402	145	3ART8VC3	GC116	1 - 3	43255	43154	70
34130	SH240	48	359-218	SGR402	145	3ART8VC4	GC116	1 - 3	4327709	DP112	130 to 134
34131	SH241	48	359-233	SGR412	145	3ARTVC1	GC116	1 - 3	4328133	SGR403	145
34132	SH242	48	359-234	SGR412	145	3K11012/13	LB237	120 to 124	4329225	DP113	130 to 134
34133	SH243	48	359-244	SGR402	145	400011	L225	91, 94, 97, 103, 104 & 117	4330786	DP160	130 to 134
34134	SH244	48	359-247	SGR411	145	400198	L180-40	94, 97, 103, 104 & 117	4331193	SGR403	145
34135	SH245	48	359-262	SGR412	145	400199	SET111	103 & 104	4331669	SGR403	145
34136	SH246	48	359-263	SGR412	145	400209	L225	91, 94, 97, 103, 104 & 117	4332948	SGR403	145
34137	SH247	48	359-264	SGR402	145	400296	SET109	91, 103 & 104	4333355	SGR403	145
34138	SH248	48	359449	LP634	87	40040301	LP127	78, 83	4333356	SGR403	145
34139	SH249	48	359507	LP220	87	40051501	LB254	120 to 124	4335338	SGR403	145
34140	SH250	48	36863P	LP127	78, 83				4336387	SGR403	145
34141	SH251	48	369P3	SDE359	92				4336679	DP146	130 to 134
34142	SH252	48	3700300	LB294	120 to 124						

Reference No.	Supco No.	Page	Reference No.	Supco No.	Page	Reference No.	Supco No.	Page	Reference No.	Supco No.	Page
43018	43005	68	4387637	SCS97	39 to 44	483105	IMM8366	20 to 27	51835	DE793	92
43-0283	LB131	120 to 124	4387638	SCS116	39 to 44	489P3	L255	103, 104 & 117	51879	LD120	91, 94, 103 & 117
43053	43054	69	4387639	SCS116	39 to 44	490P3	SET200	91 & 109	51880	LD120	91, 94, 103 & 117
430540	ES16200	78, 92, 106, & 118	4387641	SCS116	39 to 44	492P3	L255	103, 104 & 117	51880A	LD145	91, 97 & 117
430542	ES16806	83, 93, 95, 100, 101, 108 & 119	4389140	SM343	10 - 11	5007S	FB456	19	51897	SET110	91, 103 & 104
43103	43154	70	4389141	SM328	10 - 11	500807	LD120	91, 94, 103 & 117	519160	SGR401	145
431177	L340	91, 97, 104 & 117	4389142	SM345	10 - 11	501A	SGR412	145	519218	SM327	10 - 11
43153	43154	70	4389144	SM399	10 - 11	502498	L15510W	91, 103, 104, & 109	51986	LD120	91, 94, 103 & 117
43157	43154	70	4389145	SM346	10 - 11	503551	L15525W	91, 109 & 116	51987	LD120	91, 94, 103 & 117
4317943	RIM500	20 to 27	4389195	SA1005	9, 22, 26, & 27	503552	L15510W	91, 103, 104, & 109	520024	SM327	10 - 11
4318001	SM343	10 - 11	4389493	SGR403	145	503554	L15525W	91, 109 & 116	52079	DE794	92
4318002	SM328	10 - 11	4389591	DP166	130 to 134	5036F	FB456	19	520819	SCS27	39 to 44
4318083	IC100	32	4389592	DP167	130 to 134	503979	LD135	91, 94, 97, 103 & 117	520825-13	SL45	55
4318297	SP697	61	4391960	DE698	113	504091	25M01A-100	92 to 110	52085-1	SL55	55
4319392	LB278	120 to 124	4391969	SSD6	88 & 89	504237	FL225	91, 103 & 116	52085-10	SL45	55
4320913	SGR412	145	4391974	SPF17633	6	504514	L15510W	91, 103, 104, & 109	52085-11	SL55	55
43218	SH416	53 & 54	4391996	SDE364	93, 96, 100, 106 & 113	504515	L15510W	91, 103, 104, & 109	52085-12	SL60	55
4322910	SGR403	145	4392003	SDE350	92, 96, 100, 106 & 113	504516	L120	91, 97, 103, & 117	52085-13	SL45	55
4324056	DP125W	130 to 134	4392018	SGR408	145	504517	L15525W	91, 109 & 116	52085-15	SL55	55
43255	43154	70	4392019	SGR407	145	504518	L155	91, 97, 103, 104 & 117	52085-17	SL80	55
4327709	DP112	130 to 134	4392020	SGR409	145	504519	L14520W	91, 104, 109 & 116	52085-19	SL8519	56, 58 to 60
4328133	SGR403	145	4392021	SGR411	145	504570	ES16806	83, 93, 95, 100, 101, 108 & 119	52085-20	SL60	55
4329225	DP113	130 to 134	4392022	SGR407	145	50850	L200	91, 94, 103, 104 & 117	52085-22	SL8528	56, 58 to 60
4330786	DP160	130 to 134	4392023	SGR412	145	50851	L225	91, 94, 97, 103, 104 & 117	52085-24	SL8528	56, 58 to 60
4331193	SGR403	145	4392065	DE702K	113	510124	DE407	93	52085-25	SL8528	56, 58 to 60
4331669	SGR403	145	4392949	WF271	29	510177	DE902M	96, 99, 107 & 110	52085-28	SL8528	56, 58 to 60
4332948	SGR403	145	4394996	SDE364	93, 96, 100, 106 & 113	510178	LB254	120 to 124	52085-29	SL8513	56, 58 to 60
4333355	SGR403	145	4396088	DP334	130 to 134	510184P	SDE364	93, 96, 100, 106 & 113	52085-3	SL55	55
4333356	SGR403	145	4396089	DP333	130 to 134	5101B	FB455	12 & 19	52085-30	SL8517	56, 58 to 60
4333538	SGR403	145	4396092	DP133	130 to 134	510213	DE353	93, 96, 101, 106 & 111	52085-33	SL8528	56, 58 to 60
4336387	SGR403	145	4396093	DP134	130 to 134	51036	L150	91, 94, 103, 104 & 117	52085-4	SL60	55
4336679	DP146	130 to 134	46197020089	LB293	120 to 124	510701	FL225	91, 103 & 116	52085-5	SL45	55
4336680	DP147	130 to 134	468150	RIM900	20 to 27	510702	SLF255VA	91, 103 & 114	52085-6	SL60	55
4336770	DP125	130 to 134	46-9906	WF284	30	511255	LB254	120 to 124	52085-7	SL60	55
4337848	SGR412	145	46-9906P	WF284	30	511255P	LB340	120 to 124	52085-9	SL45	55
4338008	SGR403	145	46-9910	WF284	30	511412	SET182	91	52121-1	SM334	9 & 11
4338036	SGR403	145	46-9910P	WF284	30	51143	ES16200	78, 92, 106, & 118	52304-1	RIM900	20 to 27
4338568	DP158	130 to 134	46-9914	WF282	29	51172-131-5	Q107	67	52305-1	RIM900	20 to 27
4339427	SCS102	39 to 44	4725C	SL5708	57 to 60	51172-22	Q104	67	52305-3	RIM900	20 to 27
43403	43558	70	4751C	SL5709	57 to 60	51172-32	Q105	67	52305-4	RIM900	20 to 27
4342525	SGR403	145	480478	SL2697	57 to 60	51172-33	Q106	67	52305-6	RIM900	20 to 27
4342528	SGR403	145	480594	SL2697	57 to 60	51185	SET102	91 & 103	52305-8	RIM900	20 to 27
4343267	SCS107	39 to 44	480595	SL2697	57 to 60	51186	FL200	94, 97, 103, 104 & 116	52393	SET121	91, 97, 103 & 104
4343917	SL7503	57 to 60	480616	RIM500	20 to 27	512274	SCS27	39 to 44	52394	SET109	91, 103 & 104
4349502	SGR403	145	480617	RIM500	20 to 27	513315	SL2697	57 to 60	52530-1	SH311	52 & 54
4356928	SL8513	56, 58 to 60	480639	SM327	10 - 11	513543	FB353	19	52530-6	SH311	52 & 54
435P3	LB254	120 to 124	480851	SL2697	57 to 60	513548	SL2697	57 to 60	52556	LB251	120 to 124
4363351	SGR412	145	481227	SL2697	57 to 60	513574	SL2697	57 to 60	52637000	SM551	16
4363761	SGR403	145	482014	RIM500	20 to 27	51386	LD130	91, 94, 97, 103 & 104	52763-1	SH277	50, 52, & 54
4371216	SGR410	145	482015	RIM500	20 to 27	51387	LD155	91, 94, 97, 103 & 117	52763-7	SH277	50, 52, & 54
4372474	SGR412	145	482016	RIM500	20 to 27	513989	SL2697	57 to 60	52763-9	SH277	50, 52, & 54
4372534	SGR412	145	482017	RIM500	20 to 27	513990	SL2697	57 to 60	52764-1	SH311	52 & 54
4372535	SGR412	145	482018	RIM500	20 to 27	515235	SM327	10 - 11	52764-14	SH311	52 & 54
4387489	SL3084	57 to 60	482019	RIM500	20 to 27	515246	SL2697	57 to 60	52764-15	SH374	52 & 54
4387490	SL7490	57 to 60	482020	RIM900	20 to 27	515315	SL2697	57 to 60	52764-22	SH311	52 & 54
4387498	SL6155	57 to 60	482021	RIM500	20 to 27	517441	SM327	10 - 11	52764-24	SH311	52 & 54
4387499	SL3084	57 to 60	482156	CS189-227X	66 & 87	517472	SM327	10 - 11	52764-64	SH311	52 & 54
4387500	SL7500	57 to 60	482290	SL2697	57 to 60				52764-8	SH311	52 & 54
4387501	SL8513	56, 58 to 60	482394	RIM500	20 to 27				527698	SCS27	39 to 44
4387503	SL7503	57 to 60	482415	SM328	10 - 11				52881-24	GC183	1 - 3
4387566	SCS102	39 to 44	482433	RIM500	20 to 27				52881-25	GC183	1 - 3
4387577	SCS103	39 to 44	482468	SM327	10 - 11				52881-33	GC183	1 - 3
4387580	SCS103	39 to 44	482469	SM328	10 - 11				52881-34	GC183	1 - 3
4387590	SCS46	39 to 44	482470	SM343	10 - 11				52881-36	GC183	1 - 3
4387602	SCS112	39 to 44	482493	SC802	7				52881-45	GC183	1 - 3
4387603	SCS99	39 to 44	482671	SA1005	9, 22, 26, & 27				52881-47	GC183	1 - 3
4387604	SCS99	39 to 44	482697	SL2697	57 to 60				52881-5	GC183	1 - 3
4387605	SCS99	39 to 44	482729	SM328	10 - 11				5300007959	SGR412	145
4387607	SCS98	39 to 44	482731	SM343	10 - 11				5300009190	SGR412	145
4387608	SCS115	39 to 44	482733	SM343	10 - 11				5300063253	LB151	120 to 124
4387609	SCS75	39 to 44	482990	RIM500	20 to 27				5300063510	LB212	120 to 124
4387617	SCS79	39 to 44	483006	SL2697	57 to 60				5300086493	GC161	1 - 3
4387622	SCS105	39 to 44	483007	SL2697	57 to 60						
4387623	SCS105	39 to 44	483042	IMM8366	20 to 27						
4387624	SCS105	39 to 44	483051	SM328	10 - 11						
4387634	SCS97	39 to 44	483084	SL3084	57 to 60						
			483101	IMM8366	20 to 27						

Reference No.	Supco No.	Page	Reference No.	Supco No.	Page	Reference No.	Supco No.	Page	Reference No.	Supco No.	Page
5301167733	RR110	129	5303007173	IC102	32	5303300829	SL2691	56, 58 to 60	5305510264	C25	28
5301167945	DE414	95	5303007540	SL2690	56, 58 to 60	5303300840	SL2691	56, 58 to 60	5306599388	SM316	9 & 11
5301228589	SL50	55	5303013588	DP113	130 to 134	5303300853	SL2691	56, 58 to 60	5306599389	SM316	9 & 11
5301230220	SL60	55	5303015195	SL2691	56, 58 to 60	5303304035	SFPC	57	53-0665	DE700	107
5301321263	SGR401	145	5303015865	SL55	55	5303308266	SL2691	56, 58 to 60	530668	SL70	55
53-0171	SET106	103 & 104	5303016211	SGR409	145	5303308291	SL2691	56, 58 to 60	530675	SM327	10 - 11
53-0186	LB276	120 to 124	5303017373	SWC41	37, 40 to 44	5303308452	SGR412	145	530679	SL70	55
53-0197	DE689	107	5303018555	SWC22	37, 40 to 44	5303308468	SGR412	145	53-0700	SET106	103 & 104
530215	SL2697	57 to 60	5303018792	SWC22	37, 40 to 44	5303309908	SL50	55	53-0701	DE531	107
530216	SL2697	57 to 60	53-0306	SET115	94 & 104	5303309910	SL55	55	5307512516	SFR75	37, 40 to 44
530217	SL2697	57 to 60	53-0310N	DE777	107	5303309911	SL60	55	5307529591	LB271	120 to 124
530253	SL2697	57 to 60	53-0311N	DE690	107	5303310100	SM336	9 & 11	5307531200	L13515W	94, 97 & 116
530254	SL2697	57 to 60	53-0312N	DE696	108	5303311375	SL45	55	5307531201	L13510W	94, 97 & 116
53-0262	SET195	103, 104 & 109	5303131115	DP103	130 to 134	5303311376	SL70	55	5307531358	FL320	94, 103 & 116
53-0263	SET106	103 & 104	5303131300	SGR411	145	5303320997	SET105	91, 94, 97, 103 & 104	5307537239	LB204	120 to 124
5302834353	LB110	120 to 124	530314	SM327	10 - 11	5303321453	GC193	1 - 3	530763	SM327	10 - 11
5303001304	SWC55	37, 40 to 44	5303161099	LB202	120 to 124	5303321915	D1401AMO	8	530764	GC185	1 - 3
5303001362	SH419	51 & 54	5303161103	DE413	95	5303323233	SFPC	57	53-0771	SET176	104
5303001398	SWC58	37, 40 to 44	5303161152	LB113	120 to 124	5303351197	DW116	73	5308000068	GC161	1 - 3
5300131743	SET119	94 & 109	530317	SL2697	57 to 60	530341	SH222	49	5308001651	LB210	120 to 124
5300131961	DP116	130 to 134	530318	SL2697	57 to 60	5303912510	LP118	78	5308001690	L150	91, 94, 103, 104 & 117
5300131964	DP117	130 to 134	5303200258	SWC20	37, 40 to 44	5303912530	LP394	78	5308001832	LB111	120 to 124
5300131986	DP131	130 to 134	5303200274	SWC49	37, 40 to 44	5303912558	SL50	55	5308002451	LB117	120 to 124
5300131987	DP132	130 to 134	5303200508	SGR409	145	5303912567	SGR407	145	5308002726	GC161	1 - 3
5300137504	DE520	95 & 102	5303200799	SWC49	37, 40 to 44	5303912586	SGR401	145	5308003113	DP131	130 to 134
5300147221	DP106	130 to 134	5303200810	GC161	1 - 3	5303912666	RR109	129	5308003114	DP132	130 to 134
5300147223	DP107	130 to 134	5303202296	SL50	55	5303912727	SM336	9 & 11	5308003635	GC161	1 - 3
5300158066	SH445	51 & 54	5303203018	LB295	120 to 124	5303917278	SM378	9 & 11	5308006498	LB152	120 to 124
5300158289	SM336	9 & 11	5303206641	SWC22	37, 40 to 44	5303917473	SM336	9 & 11	5308006679	GVW151	78, 80, 81, 83, 87
5300169845	LD120	91, 94, 103 & 117	5303206885	OL4	32	5303917595	ES16802	24, 73, 119	5308007095	GC161	1 - 3
5300169849	LD140	91, 94, 103, 104 & 117	5303207018	DP161	130 to 134	5303917625	SL2690	56, 58 to 60	5308007104	SGI47	37, 40 to 44
5300169850	LD155	91, 94, 97, 103 & 117	5303207345	SWC61	37, 40 to 44	5303917626	SL2690	56, 58 to 60	5308007115	SGI46	37, 40 to 44
5300169851	LD120	91, 94, 103 & 117	5303207418	GVW151	78, 80, 81, 83, 87	5303917627	SL2690	56, 58 to 60	5308007122	SWC21	37, 40 to 44
5300169853	LD135	91, 94, 97, 103 & 117	5303207520	SGR412	145	5303917628	SL50	55	5308007123	SWC20	37, 40 to 44
5300169857	LD210	94 & 117	5303207521	SGR412	145	5303917629	SL2691	56, 58 to 60	5308007988	SGR403	145
5300169858	LD240	94 & 117	5303211396	SL2690	56, 58 to 60	5303917630	SL60	55	5308009420	SGR412	145
5300169860	LD305	94 & 117	5303211431	DE790	96 & 100	5303917633	SPF17633	6	5308009754	SH457	51 & 54
530017854	DE381	93, 95 & 110	5303211472	SLF330VA	94 & 114	5303917634	SC802	7	5308010244	SWC55	37, 40 to 44
5300184701	ES16200	78, 92, 106, & 118	53032161027	DE381	93, 95 & 110	5303917752	WF284	30	5308011166	SL2690	56, 58 to 60
53001P	DE795	92	5303261151	LB150	120 to 124	5303917836	WF284	30	5308011289	LB111	120 to 124
5300219245	RR105	129	5303261155	LB151	120 to 124	5303917937	WF284	30	5308011431	DP160	130 to 134
5300234600	DE338	95 & 101	530327	SL2697	57 to 60	5303917954	SL2691	56, 58 to 60	5308011452	SGR412	145
5300280162	SWE58	37, 40 to 44	5303270406	OL2	32	5303918015	SM316	9 & 11	5308011453	SGR412	145
5300280163	SWE55	37, 40 to 44	5303271473	SWC66	37, 40 to 44	5303918017	WF284	30	5308011454	SGR409	145
5300286103	SL70	55	5303275771	SWC22	37, 40 to 44	5303918277	RIM116	20 to 27	5308011455	SGR412	145
53003	SM334	9 & 11	5303275772	SWC12	37, 40 to 44	5303931775	DE382WR	94, 96, 98, 105 & 109	5308013213	L135	91, 94, 97 & 117
53003-1	SM334	9 & 11	5303276514	OL3	32	5303935053	DP143	130 to 134	5308013595	SET104	94, 97, 104 & 109
5300460792	SL6792	56, 58 to 60	5303276623	LB291	120 to 124	5303935054	DP113	130 to 134	5308015544	SWC12	37, 40 to 44
5300460793	SL60	55	5303279149	SFPC	57	5303935055	DP142	130 to 134	5308015762	GC161	1 - 3
5300600831	SDE350	92, 96, 100, 106 & 113	5303279266	SL2691	56, 58 to 60	5303935057	DP112	130 to 134	5308015763	GC161	1 - 3
5300622032	DE335	95	530328	SL2697	57 to 60	5303935058	RR117	129	5308015847	L145DC	94, 97 & 115
5300622034	DE336	95	5303280326	LB113	120 to 124	5303935066	SGR412	145	5308015856	FL200	94, 97, 103, 104 & 116
5300622451	LB155	120 to 124	5303280336	DP112	130 to 134	5303935068	SGR407	145	5308017217	GC161	1 - 3
5300624974	SFR100	37, 40 to 44	5303281008	DE727	95	5303937139	DE790	96 & 100	5308017218	GC161	1 - 3
5300628518	B1401FO	8	5303281034	L13515W	94, 97 & 116	5303937186	SDE364	93, 96, 100, 106 & 113	5308017430	SWC49	37, 40 to 44
5300629464	SL50	55	5303281044	ES16806	83, 93, 95, 100, 101, 108 & 119	5303943007	DW114	73	5308017445	GC161	1 - 3
5300633905	L200	91, 94, 103, 104 & 117	5303281049	DE766	95	530435	SL2697	57 to 60	5308027638	LB291	120 to 124
5300634209	L190	94 & 117	5303281113	FL285	94 & 116	5304401265	SGR403	145	5308057415	DE695	96
5300638957	LB201	120 to 124	5303281135	DE353	93, 96, 101, 106 & 111	5304402782	SFPC	57	5308057416	DE694	96
5300639357	LB202	120 to 124	5303281153	DE724	96 & 102	5304404033	SGI47	37, 40 to 44	5308057417	DE694	96
5300900072	SC807	7	5303281154	LB260	120 to 12	5304404821	GC193	1 - 3	5308057424	LB210	120 to 124
5301124534	SFR85	37, 40 to 44	5303281154	LB260	120 to 12	5304406555	SC952	8	5308067970	SGR407	145
5301126982	SDE350	92, 96, 100, 106 & 113	5303281155	SL55	55	5304413855	SL45	55	530807680	ES16802	24, 73, 119
5301135442	SM332	9 & 11	5303281155	SL55	55	5304413856	SL70	55	530809703	DW118	73
5301135914	SM332	9 & 11	5303281155	SL55	55	5304415914	SL45	55	5308871201	SL2690	56, 58 to 60
5301137820	SM333	9 & 11	5303281155	SL55	55	5304415916	SL50	55	5308871202	SL2690	56, 58 to 60
5303001399	SWC55	37, 40 to 44	5303281155	SL55	55	5304415917	SL60	55	5308871203	SL2690	56, 58 to 60
5303001453	GC161	1 - 3	5303281155	SL55	55	5304415918	SL70	55	5308950121	SET104	94, 97, 104 & 109
5303001517	SWC41	37, 40 to 44	5303281155	SL55	55	5304432494	DP112	130 to 134	53-0918	DE530	107
5303001525	GC161	1 - 3	5303281155	SL55	55	5304432495	DP113	130 to 134	530918015	SM316	9 & 11
5303006112	GC161	1 - 3	5303281155	SL55	55	5304439725	LB260	120 to 124	530990	SL2697	57 to 60
			5303281155	SL55	55	5304440277	SDE350	92, 96, 100, 106 & 113	5309951548	SET115	94 & 104
			5303281155	SL55	55	530452	SM327	10 - 11	5309956756	SH278	51 & 54
			5303281155	SL55	55	5305010101	DP125W	130 to 134	53-1037	SET176	104

Reference No.	Supco No.	Page
53105-1	RIM900	20 to 27
53105-2	RIM900	20 to 27
53105-37	RIM900	20 to 27
53105-47	RIM900	20 to 27
53105-7	RIM900	20 to 27
531068	SL2697	57 to 60
531069	SL2697	57 to 60
53-1080	LB276	120 to 124
53-1086	LB276	120 to 124
53-1095	SET106	103 & 104
53-1096	SET404	104
53-1107	SET196	104
53-1182	SET403	104
5312400035	SGR412	145
53132	DE791	92
53-1459	SET176	104
531479	SL2697	57 to 60
531480	SL2697	57 to 60
5315282802	SGE433	36, 38, 40 to 44
5316269001	SL2690	56, 58 to 60
531645	SM327	10 - 11
531646	SM327	10 - 11
531647	SM327	10 - 11
531648	SM327	10 - 11
531668	SL2697	57 to 60
531669	SL2697	57 to 60
531676	SL2697	57 to 60
531678	SL2697	57 to 60
531679	SL2697	57 to 60
531680	SL2697	57 to 60
531688	SL70	55
531689	SL2697	57 to 60
531690	SL2697	57 to 60
531769	SL70	55
5317842502	SH439	51 & 54
531813	SL2697	57 to 60
531814	SL2697	57 to 60
531826	SM327	10 - 11
531831	SL70	55
5318680302	SWC21	37, 40 to 44
5318680305	SWC23	37, 40 to 44
5318680311	SWC26	37, 40 to 44
5318693207	SGI47	37, 40 to 44
531885	SM327	10 - 11
53-2045	DE529	108
53-2272	DE786	108
53-2273	DE785	108
53-2671	LB276	120 to 124
53-2754	L14520W	91, 104, 109 & 116
53-2908	25M01A-101	98 to 110
53-3288	25M01A-101	98 to 110
53337	SWC58	37, 40 to 44
53338	SWC55	37, 40 to 44
531769	SL70	55
5317842502	SH439	51 & 54
531813	SL2697	57 to 60
531814	SL2697	57 to 60
531826	SM327	10 - 11
531831	SL70	55
5318680302	SWC21	37, 40 to 44
5318680305	SWC23	37, 40 to 44
5318680311	SWC26	37, 40 to 44
5318693207	SGI47	37, 40 to 44
531885	SM327	10 - 11
53-2045	DE529	108
53-2272	DE786	108
53-2273	DE785	108
53-2671	LB276	120 to 124
53-2754	L14520W	91, 104, 109 & 116
53-2908	25M01A-101	98 to 110
53-3288	25M01A-101	98 to 110
53337	SWC58	37, 40 to 44
53338	SWC55	37, 40 to 44
53339	SWC41	37, 40 to 44
53435	SL70	55
53519	DE910	92
5366021400	DE902M	96, 99, 107 & 110

Reference No.	Supco No.	Page
53706-1	SM335	9 & 11
53706-2	SM335	9 & 11
53708	SLF155VA	91 & 114
53752	L125	94, 97, 103, 104 & 117
53767-1	SM334	9 & 11
5379499000	DE784	96
53839	SH439	51 & 54
53900	SWC12	37, 40 to 44
54099H02	SGR409	145
54099H03	SGR410	145
54099H04	SGR411	145
54099H05	SGR412	145
54099H06	SGR408	145
54099H07	SGR407	145
54410	DE783	92
54415P	DE783	92
54482-1	SM335	9 & 11
54482-10	SM335	9 & 11
54482-2	SM335	9 & 11
54482-3	SM335	9 & 11
54482-4	SM335	9 & 11
54482-5	SM335	9 & 11
54482-8	SM335	9 & 11
54482-9	SM335	9 & 11
5451100	5451-100	35
545150	5451-50	35
54608	SDE359	92
547048	SL2697	57 to 60
547069	SL2697	57 to 60
547088	SL2697	57 to 60
547089	SL2697	57 to 60
547090	SL2697	57 to 60
547091	SL2697	57 to 60
547295	SL2697	57 to 60
547296	SL2697	57 to 60
547323	SL2697	57 to 60
54736	LD120	91, 94, 103 & 117
54737	LD135	91, 94, 97, 103 & 117
547454	SL2697	57 to 60
547455	SL2697	57 to 60
547585	GC185	1 - 3
547853	SL2697	57 to 60
547854	SL2697	57 to 60
547855	SL2697	57 to 60
547856	SL2697	57 to 60
547857	SL2697	57 to 60
547858	SL2697	57 to 60
547859	SL2697	57 to 60
547860	SL2697	57 to 60
547861	SL2697	57 to 60
547862	SL2697	57 to 60
547956	SM327	10 - 11
547958	SM327	10 - 11
548029	SH429	53 & 54
548030	SH429	53 & 54
548042	SM327	10 - 11
548262	SM328	10 - 11
548460	SH429	53 & 54
548463	SL2697	57 to 60
548464	SL2697	57 to 60
548635	SH414	53 & 54
548645	SH413	53 & 54
548697	SM343	10 - 11
548712	SL2697	57 to 60
548713	SL2697	57 to 60
548761	GC185	1 - 3
548762	GC185	1 - 3
548886	SL2697	57 to 60
548887	SL2697	57 to 60
548888	SL2697	57 to 60
548889	SL2697	57 to 60
548890	SL2697	57 to 60
548891	SL2697	57 to 60
548892	SL2697	57 to 60
548893	SL2697	57 to 60
548894	SL2697	57 to 60
548895	SL2697	57 to 60
548896	SL2697	57 to 60

Reference No.	Supco No.	Page
549098	SM328	10 - 11
549212	SM328	10 - 11
549392	SH414	53 & 54
549393	SH413	53 & 54
549418	SH433	53 & 54
549420	SM343	10 - 11
549433	SH433	53 & 54
549603	SH413	53 & 54
549679	GC185	1 - 3
549682	GC185	1 - 3
549698	SL2697	57 to 60
549699	SL2697	57 to 60
549700	SL2697	57 to 60
549701	SL2697	57 to 60
549757	SL2697	57 to 60
549758	SL2697	57 to 60
549928	SL2697	57 to 60
549929	SL2697	57 to 60
5500-200	ES5500200	146 - 148
5500-202	ES5500202	146 - 148
5500-203	ES5500203	146 - 148
5500-204	ES5500204	146 - 148
5500-206	ES5500206	146 - 148
5500-207	ES5500207	146 - 148
5500-225	ES5500225	146 - 148
5500-299	ES5500299	146 - 148
55024-3	SL243	55
55024-5	SL245	55
55024-7	SL247	55
550346	SGR411	145
55060	LB232	120 to 124
550735	SGR412	145
55099	L130	94, 97, 103, 104 & 117
551003	SGR412	145
551207	SGR412	145
551291	SGR412	145
553839	SCS108	39 to 44
55394-1	SM334	9 & 11
55394-3	SM334	9 & 11
55394-5	SM334	9 & 11
55394-7	SM334	9 & 11
55428	DE794	92
55488-2	SM335	9 & 11
55523	FL320	94, 103 & 116
556226	SCS108	39 to 44
556241	SCS108	39 to 44
556253	SCS108	39 to 44
55735-1	SM334	9 & 11
55735-8	SM334	9 & 11
55741	SET195	103, 104 & 109
55742	SET133	91, 103 & 104
5604-14-1	SL45	55
5604-14-2	SL60	55
5604-14-37	SL60	55
5604-14-4	SL45	55
5604-14-5	SL45	55
5604-14-6	SL60	55
5604-14-7	SL60	55
5604-14-8	SL60	55
5604-15-1	SL45	55
5604-17-1	SL45	55
5604-17-2	SL60	55
5604-18-2	SL60	55
5604-18-4	SL45	55
5604-18-5	SL45	55
5604-18-6	SL60	55
5604-19-2	SL5844	24
5604-20-3	SL45	55
5604-23-1	SL45	55
5604-23-2	SL45	55
5604-23-4	SL45	55
5604-23-5	SL2690	56, 58 to 60
56052	ES16806	83, 93, 95, 100, 101, 108 & 119
56081	SET195	103, 104 & 109
56082	SET133	91, 103 & 104
56095	LB270	120 to 124
56095P	LB270	120 to 124
56115	SET110	91, 103 & 104
56221	L255	103, 104 & 117

Reference No.	Supco No.	Page
56225A	DE381	93, 95 & 110
56231	DE353	93, 96, 101, 106 & 111
56287-11	SAD77	38
562P3	LP1586	78, 83, 85, 90
56321	DE353	93, 96, 101, 106 & 111
56410	LD140	91, 94, 103, 104 & 117
56440	SET105	91, 94, 97, 103 & 104
56461	DE796	93
56470	L150	91, 94, 103, 104 & 117
56471	L120	91, 97, 103, & 117
56488-1	SM334	9 & 11
56488-2	SM334	9 & 11
56488-3	SM334	9 & 11
56488-4	SM334	9 & 11
56488-5	SM334	9 & 11
56856	L155	91, 97, 103, 104 & 117
56970	SDE359	92
57015	L155	91, 97, 103, 104 & 117
57239	LD120	91, 94, 103 & 117
5749920	LB300	120 to 124
576399	SCS108	39 to 44
576400	SCS108	39 to 44
581985	SCS108	39 to 44
5830920	LB301	120 to 124
58366	L255	103, 104 & 117
58804	25M01A-100	92 to 110
58804A	DE382AWR	93, 94, 95, 98, 105, 109
58804B	DE382BWR	93, 94, 95, 98, 105, 109
58823	SDE359	92
59000A	FB590	18
59174	LB254	120 to 124
600-052	SPP6	62
600-057	SPP5	62
6000A0NI-87	Q103	67
6000A0NI-97	Q102	67
6000A0NI-98	Q101	67
600-410	RC0410	31
6007-356-6	SPH52	37, 40 to 44
6007-356-7	SPH53	37, 40 to 44
600-810	RC0810	31
60106-1	SH319	52 & 54
60106-13	SH319	52 & 54
60106-14	SH320	52 & 54
60106-15	SH326	52 & 54
60106-17	SH320	52 & 54
60106-19	SH319	52 & 54
60106-2	SH320	52 & 54
60106-20	SH320	52 & 54
60106-21	SH326	52 & 54
60106-23	SH320	52 & 54
60106-25	SH319	52 & 54
60106-26	SH320	52 & 54
60106-27	SH326	52 & 54
60106-28	SH319	52 & 54
60106-29	SH320	52 & 54
60106-3	SH326	52 & 54
60106-30	SH326	52 & 54
60106-32	SH320	52 & 54
60106-34	SH319	52 & 54
60106-35	SH320	52 & 54
60106-36	SH326	52 & 54
60106-38	SH320	52 & 54
60106-40	SH320	52 & 54
60106-41	SH320	52 & 54
60106-44	SH320	52 & 54
60-1267	LB240	120 to 124
60191	L225	91, 94, 97, 103, 104 & 117
60-2385	L200	91, 94, 103, 104 & 117

Reference No.	Supco No.	Page	Reference No.	Supco No.	Page	Reference No.	Supco No.	Page	Reference No.	Supco No.	Page
60-2386	L180-40	94, 97, 103, 104 & 117	626002	RIM900	20 to 27	63-3805K	DE780	107	68233-1	SPF17633	6
60-2390	L125	94, 97, 103, 104 & 117	62608400	LB297	120 to 124	63-3862	LB217	120 to 124	68233-2	B1401FO	8
60-2713	L200	91, 94, 103, 104 & 117	626201	RIM500	20 to 27	63-3988	L255	103, 104 & 117	68233-3	SPM6823-3	6
60353	25M01A-100	92 to 110	626237	RIM500	20 to 27	63-3989	L255	103, 104 & 117	68601-1	GC183	1 - 3
60353P	25M01A-100	92 to 110	626366	RIM500	20 to 27	63-4574	L155	91, 97, 103, 104 & 117	68601-2	GC183	1 - 3
60413-4	SL8517	56, 58 to 60	62641	FL225	91, 103 & 116				68601-3	GC183	1 - 3
60-4324	SET105	91, 94, 97, 103 & 104	626461	RIM500	20 to 27	63-4663	LB217	120 to 124	68601-4	GC183	1 - 3
60-4326	SET109	91, 103 & 104	626489	RIM500	20 to 27	63-5007	LB217	120 to 124	68601-5	GC183	1 - 3
60-4327	L200	91, 94, 103, 104 & 117	62649	DE691	93	63-5013	DE353	93, 96, 101, 106 & 111	68601-6	GC183	1 - 3
60-4941	L180-40	94, 97, 103, 104 & 117	626500	SA1005	9, 22, 26, & 27	63510	LB212	120 to 124	68601-7	GC183	1 - 3
60-5182	L200	91, 94, 103, 104 & 117	626501	SA1005	9, 22, 26, & 27	63-5254	L340	91, 97, 104 & 117	68601-8	GC183	1 - 3
60667	25M01A-100	92 to 110	626502	SA1005	9, 22, 26, & 27	63-5256	L340	91, 97, 104 & 117	68626000	SM140-40A	12
60-7180	SET109	91, 103 & 104	626503	SA1005	9, 22, 26, & 27				68627000	SM555	16
60-7420	LD130	91, 94, 97, 103 & 104	626504	SA1005	9, 22, 26, & 27				686605	ES15907	93, 112, & 118
60-7421	SET110	91, 103 & 104	626505	SA1005	9, 22, 26, & 27				688166	DE411	102 & 112
60-7424	SET103	103, 104 & 109	626506	SA1005	9, 22, 26, & 27	63-5264	LB217	120 to 124	68920	SB001	18
60-7506	SET140	104	626507	SA1005	9, 22, 26, & 27	63-5532	SET105	91, 94, 97, 103 & 104	68929300	FB660	18
60-7879	L150	91, 94, 103, 104 & 117	626508	SA1005	9, 22, 26, & 27	63-5533	L155	91, 97, 103, 104 & 117	68972-1	RIM900	20 to 27
60-7880	L250	94, 104 & 117	626511	SA1005	9, 22, 26, & 27	63-5541	ES16200	78, 92, 106, & 118	68972-4	RIM900	20 to 27
60-9204	SET109	91, 103 & 104	626512	SA1005	9, 22, 26, & 27				689935	SET122	109
60-9210	SET110	91, 103 & 104	626513	SA1005	9, 22, 26, & 27				690634	DE522	111
60-9211	SET109	91, 103 & 104	626514	SA1005	9, 22, 26, & 27	63-5719	DE780	107	69106-1	SM362	10 - 11
60938312	SPA1403FL	6	626517	SA1005	9, 22, 26, & 27	63589	L205	94, 97, 103 & 117	69106-2	SM362	10 - 11
60954	10C7	83, 93, & 150	626519	SA1005	9, 22, 26, & 27				69106-4	SM362	10 - 11
60-9587	SET103	103, 104 & 109	626519R	SA1005	9, 22, 26, & 27				691366	DE411	102 & 112
60968	SDE359	92	626520	SA1005	9, 22, 26, & 27	63-6035	LB244	120 to 124	691371	LB271	120 to 124
61001139	SH311	52 & 54	626522	SA1005	9, 22, 26, & 27	63-6187	L340	91, 97, 104 & 117	691581	LP985	85, 112 & 119
61001140	SH374	52 & 54	626524	SA1005	9, 22, 26, & 27				691581D	LP985D	85, 112 & 119
61001846	SH311	52 & 54	626608	RIM500	20 to 27	63-6301	DE780	107	693306	LB276	120 to 124
61001874	SH374	52 & 54	626609	RIM500	20 to 27	63-6305	SET105	91, 94, 97, 103 & 104	694088	LB279	120 to 124
61002046	SH277	50, 52, & 54	626626	RIM500	20 to 27				694089	DE601	112
61005508	RIM900	20 to 27	627051	SL5844	24	63-6306	SET163	97, 103 & 104	694416	LB276	120 to 124
61005789	GC195	1 - 3	62706950	LB294	120 to 124	63-6333	LB244	120 to 124	69452302	RIM900	20 to 27
611-007	Q107	67	627180	SL5844	24	63675000	SM552	16	69452310	RIM900	20 to 27
611-232	Q105	67	627512	ES16802	24, 73, 119	63-6786	25M01A-101	98 to 110	69452329	RIM900	20 to 27
611-233	Q106	67	627572	RIM500	20 to 27	63700300	LB279	120 to 124	69452337	RIM900	20 to 27
611-241	Q101	67	627797	IMM8366	20 to 27	638957	LB201	120 to 124	69463673	RIM900	20 to 27
611-242	Q102	67	627801	IMM8366	20 to 27	639357	LB202	120 to 124	694674	SET177	109
611-244	Q103	67	627808	SL7985	24	6450-237-1	SH224	49	694868	LB276	120 to 124
611-245	Q104	67	627811	IMM8366	20 to 27	6490-084-02	SH270	50 & 54	695055	LB276	120 to 124
61210	FL225	91, 103 & 116	627816	IMM8366	20 to 27	6490-099-1K	SH415	51 & 54	695397	DE382BWR	93, 94, 95, 98, 105, 109
61372	FLD135	91, 103 & 116	627984	SL7985	24	65100	SM550	16	695398	DE382AWR	93, 94, 95, 98, 105, 109
61401	L130	94, 97, 103, 104 & 117	627985	SL7985	24	65101	SM551	16	695499	DE601	112
614T018F01	DP131	130 to 134	628134	IMM8366	20 to 27	65103	SM552	16	695925	SM279827	111
614T018F02	DP132	130 to 134	628135	IMM8366	20 to 27	65104	SM553	16	696818	SET113	109
61556	L225	91, 94, 97, 103, 104 & 117	628209	SL7985	24	65105	SM554	16	697388	LB276	120 to 124
61625	L15515W	116	628210	GA31	25	65106	SM555	16	69848-1	SH311	52 & 54
61886	SLF255VA	91, 103 & 114	628247	IMM8366	20 to 27	65638-1	RIM900	20 to 27	69848-11	SH311	52 & 54
62148	SET109	91, 103 & 104	628258	IMM8366	20 to 27	65878000	SM550	16	69848-12	SH374	52 & 54
623288	SH274	50 & 54	628302	IMM8366	20 to 27	6599346	SH274	50 & 54	69848-2	SH374	52 & 54
625601	RIM500	20 to 27	628303	IMM8366	20 to 27	660996	LB276	120 to 124	69958-1	FB718	18
625603	RIM500	20 to 27	628305	IMM8366	20 to 27	660997	LB276	120 to 124	70001036	SGR412	145
625610	RIM500	20 to 27	628332	IMM8366	20 to 27	66128-1	A1401ADO	8	70025-2	SAD99	38
625611	RIM500	20 to 27	628342	IMM8366	20 to 27	661561	LB276	120 to 124	70025-4	SAD97	38
625622	RIM500	20 to 27	628357	IMM8366	20 to 27	661570	LB254	120 to 124	70025-5	SAD100	38
625625	RIM500	20 to 27	628384	SA1005	9, 22, 26, & 27	66545-1	GC183	1 - 3	70025-6	SAD101	38
625653	RIM500	20 to 27	628384R	SA1005	9, 22, 26, & 27	66545-2	GC183	1 - 3	70047-1	SAD67	38
625656	RIM500	20 to 27	628386	SA1005	9, 22, 26, & 27	66582000	SM553	16	70047-2	SAD69	38
625660	RIM500	20 to 27	628397	SL7985	24	6662100	6662-100	35	70047-3	SAD71	38
62577-1	RIM900	20 to 27	628398	IMM8366	20 to 27	666250	6662-50	35	70048-1	SAD68	38
62577-11	RIM900	20 to 27	628399	IMM8366	20 to 27	66-6615	DE382WR	94, 96, 98, 105 & 109	70048-2	SAD70	38
62577-13	RIM900	20 to 27	62872	ES16806	83, 93, 95, 100, 101, 108 & 119	66857-1	IC102	32	70048-4	SAD73	39 to 44
62577-4	RIM900	20 to 27	628943	SH416	53 & 54	66858-1	IC102	32	70048-5	SAD81	39 to 44
62577-5	RIM900	20 to 27	62934-2	FB718	18	66929-31	SAD76	38	70053105	LB270	120 to 124
62577-6	RIM900	20 to 27	62959	25M01A-100	92 to 110	67001263	RIM900	20 to 27	70107001	ES16806	83, 93, 95, 100, 101, 108 & 119
62577-7	RIM900	20 to 27	63-1170K	DE782	107	67001740	RIM900	20 to 27			
625843	SH416	53 & 54	63-1195C	DE247	107	67005153	RIM900	20 to 27			
625844	SL5844	24	63-1361	LB217	120 to 124	674744	DW307	76			
625963	SH416	53 & 54	63-1375	SET137	97 & 104	674819	ES16100	76, 81, 111, 112 & 118			
62600	FL350	103 & 116	63-1458	SET106	103 & 104				70-2548	SET176	104
			63-1551	SET121	91, 97, 103 & 104	675611	DW308	76	707234	RR382	129
			63-1552	L130	94, 97, 103, 104 & 117	67679-1	SH311	52 & 54	7112P004-60	RR382	129
			631648	SM327	10 - 11	67679-2	SH374	52 & 54	716348	DW605	76
			63-2825	SET133	91, 103 & 104	68111-1	RIM900	20 to 27	72306D	SGR412	145
			63-3161	LB217	120 to 124	68119-1	GC183	1 - 3	73-0028	LB287	120 to 124
			63-3301	L130	94, 97, 103, 104 & 117	68119-2	GC183	1 - 3	73-0062	SET109	91, 103 & 104
						68119-3	GC183	1 - 3	73-0063	SET109	91, 103 & 104
						68119-5	GC183	1 - 3	73-0065	SET109	91, 103 & 104
						68119-6	GC183	1 - 3	73-0155	SET109	91, 103 & 104
									73382	LB275	120 to 124

Reference No.	Supco No.	Page
74001212	DP110	130 to 134
74001213	DP111	130 to 134
74001479	DP147	130 to 134
74004068	DP333	130 to 134
74007398	SGR412	145
74007399	SGR412	145
74007498	SGR412	145
74008064	SGR412	145
74-06-170	SGR402	145
74-06-199	SGR402	145
74-06-219	SGR402	145
7432M075-60	SGR412	145
7432P025-60	SGR412	145
7432P025-60K	SGR412	145
7432P026-60	SGR412	145
7432P032-60	SGR411	145
7432P033-60	SGR412	145
7432P035-60	SGR412	145
7432P036-60	SGR411	145
7432P040-60	SGR412	145
7432P051-60	SGR412	145
7432P051-60K	SGR409	145
7432P052-60	SGR412	145
7432P052-60K	SGR412	145
7432P062-60	SGR412	145
7432P064-60	SGR412	145
7432P066-60	SGR412	145
7432P067-60	SGR412	145
7432P075-60	SGR412	145
7432P076-60	SGR412	145
7432P106-60	SGR412	145
75098	LB231	120 to 124
7537239	LB204	120 to 124
755182	SM327	10 - 11
756048	SM327	10 - 11
757073	LB233	120 to 124
76028	LB120	120 to 124
76660	LP920	81, 84, & 90
76663	LP655	84
77194-4	GC195	1 - 3
7725P013-60	DP146	130 to 134
7725P014-60	DP113	130 to 134
7725P015-60	DP112	130 to 134
77284-3	SH277	50, 52, & 54
786324	SGR408	145
786924	SGR408	145
78794	LB117	120 to 124
790023	SGR412	145
790401	SGR412	145
7954	SGR403	145
7959	SGR412	145
7960	SGR412	145
7964	SGR412	145
797991	RIM500	20 to 27
8001651	LB210	120 to 124
8001832	LB111	120 to 124
8002451	LB117	120 to 124
8003	C25D	28
80040	LP338	84
8004064	LB113	120 to 124
80040D	LP338D	84
8006498	LB152	120 to 124
8007988	SGR403	145
8011289	LB111	120 to 124
8015132	LB151	120 to 124
8015133	LB154	120 to 124
8027638	LB291	120 to 124
80443	ES16400	85, 110 & 118
8053999	SGR403	145
8066065	LB276	120 to 124
807007	DW602	73
807008	DW601	73
807043	ES16300	73, 76, 82, 118
807680	ES16802	24, 73, 119
808180K	DW114	73
809018	DW117	73
809703	DW118	73
8112	SM343	10 - 11
8114	RIM900	20 to 27
8116	SM328	10 - 11

Reference No.	Supco No.	Page
814269	SGR412	145
814284	SGR401	145
814289	SGR403	145
814362	RK362	149
81503	RIM2000	20 to 27
816624	SGR409	145
816625	SGR412	145
816826	SGR412	145
816928	SGR403	145
8169928	SGR412	145
8181670	LB293	120 to 124
8182633	LB293	120 to 124
8184969	SGR403	145
8189501	DP110	130 to 134
8190012	SGR412	145
83001-1	OV36	33 - 34
83006	OV36	33 - 34
83007	OV38	33 - 34
8300MRT26	OV42	33 - 34
8300MRT58	OV40	33 - 34
8300MRT60	OV42	33 - 34
83011	OV42	33 - 34
83012	OV32	33 - 34
83013	OV44	33 - 34
83015	OV42	33 - 34
83016	OV34	33 - 34
83017	OV44	33 - 34
83018	OV36	33 - 34
83021	OV36	33 - 34
83022	OV38	33 - 34
83023	OV34	33 - 34
83024	OV32	33
83026	OV34	33 - 34
83029	OV32	33
83030	OV38	33 - 34
83031	OV46	33 - 34
83032	OV32	33
83033	OV32	33
83035	OV42	33 - 34
83036	OV44	33 - 34
83040	OV34	33 - 34
83042	OV36	33 - 34
83047	OV40	33 - 34
83059	OV32	33
83060	OV32	33
83063	OV44	33 - 34
83074	OV46	33 - 34
83075	OV34	33 - 34
83076	OV34	33 - 34
83077	OV36	33 - 34
83085	OV34	33 - 34
83087	OV32	33
83091	OV36	33 - 34
83092	OV34	33 - 34
83100	OV32	33
83114	OV32	33
83118	OV32	33
83131	OV38	33 - 34
831383	SL90	55
83139	OV42	33 - 34
83145	OV32	33
83145-1	OV44	33 - 34
83158	OV38	33 - 34
83160	OV36	33 - 34
83160-1	OV36	33 - 34
83161	OV42	33 - 34
83161-1	OV42	33 - 34
83162	OV32	33
83162-1	OV32	33
83163	OV42	33 - 34
83163-1	OV42	33 - 34
83165	OV36	33 - 34
83165-1	OV36	33 - 34
83166	OV38	33 - 34
83166-1	OV38	33 - 34
83167	OV32	33
83167-1	OV32	33
83168	OV46	33 - 34
83168-1	OV46	33 - 34
83169	OV32	33

Reference No.	Supco No.	Page
83169-1	OV32	33
83170	OV42	33 - 34
83170-1	OV42	33 - 34
83171	OV40	33 - 34
83171-1	OV40	33 - 34
83172	OV44	33 - 34
83172-1	OV44	33 - 34
8318084	ES8084	88 & 119
83183	OV38	33 - 34
83183-1	OV38	33 - 34
83186	OV34	33 - 34
83187	OV42	33 - 34
83188	OV34	33 - 34
83191	OV36	33 - 34
83191-1	OV36	33 - 34
83192	OV44	33 - 34
83192-1	OV44	33 - 34
83194	OV40	33 - 34
83205	OV32	33
83219	OV48	33 - 34
83224	OV32	33
83225	OV42	33 - 34
83226	OV34	33 - 34
83229	OV34	33 - 34
83237	OV36	33 - 34
83248	OV34	33 - 34
83257	OV46	33 - 34
83257-1	OV46	33 - 34
83257-2	OV46	33 - 34
83259	OV42	33 - 34
83262	OV38	33 - 34
83266	OV34	33 - 34
83280	OV36	33 - 34
83281	OV34	33 - 34
83282	OV34	33 - 34
83286	OV34	33 - 34
83287	OV36	33 - 34
56116	LD140	91, 94, 103, 104 & 117
83288	OV38	33 - 34
83289	OV42	33 - 34
83290	OV38	33 - 34
83291	OV40	33 - 34
83292	OV42	33 - 34
83293	OV46	33 - 34
83301	OV42	33 - 34
83307	OV46	33 - 34
83316	OV34	33 - 34
83321	OV44	33 - 34
83323	OV42	33 - 34
83324	OV42	33 - 34
83332	OV46	33 - 34
83333	OV50	33
83337	OV32	33
83348	OV48	33 - 34
83350	OV38	33 - 34
83354	OV48	33 - 34
83358	OV48	33 - 34
83358-1	OV48	33 - 34
83359	OV48	33 - 34
83363	OV48	33 - 34
83363-1	OV48	33 - 34
83366	OV40	33 - 34
833701	RIM900	20 to 27
83373	OV44	33 - 34
83373-1	OV44	33 - 34
833752	SM327	10 - 11
83376	OV44	33 - 34
83376-1	OV44	33 - 34
833768	SM328	10 - 11
83378	OV44	33 - 34
83382	OV48	33 - 34
83386	OV50	33
83387	OV40	33 - 34
83390	OV46	33 - 34
83391	OV40	33 - 34
83392	OV40	33 - 34
833958	SL2697	57 to 60

Reference No.	Supco No.	Page
8340	RIM2000	20 to 27
83400	OV44	33 - 34
83413	OV46	33 - 34
83413-1	OV46	33 - 34
83415	OV46	33 - 34
83419	OV34	33 - 34
83421	OV42	33 - 34
83426	OV38	33 - 34
83429	OV46	33 - 34
83430	OV46	33 - 34
83432	OV34	33 - 34
83434	OV48	33 - 34
83435	OV44	33 - 34
83437	OV34	33 - 34
83438	OV34	33 - 34
83439	OV38	33 - 34
83441	OV34	33 - 34
83444	OV34	33 - 34
83446	OV46	33 - 34
83448	OV38	33 - 34
83449	OV32	33
83451	OV48	33 - 34
83452	OV48	33 - 34
83453	OV46	33 - 34
83454	OV46	33 - 34
83455	OV48	33 - 34
83457	OV38	33 - 34
83458	OV42	33 - 34
83459	OV44	33 - 34
83460	OV38	33 - 34
83461	OV34	33 - 34
83463	OV36	33 - 34
83464	OV46	33 - 34
83466	OV34	33 - 34
83467	OV32	33
834729	DP132	130 to 134
83473	OV34	33 - 34
834730	DP131	130 to 134
83474	OV32	33
83480	OV34	33 - 34
83482	OV42	33 - 34
83497	OV32	33
83497-1	OV46	33 - 34
83498	OV46	33 - 34
83498-1	OV46	33 - 34
83545	OV46	33 - 34
83601	OV38	33 - 34
83605	OV50	33
83606	OV34	33 - 34
83613	OV34	33 - 34
83618	OV38	33 - 34
83619	OV34	33 - 34
836228	SCS79	39 to 44
83623	OV42	33 - 34
83623-1	OV42	33 - 34
83625	OV46	33 - 34
83627	OV32	33
83628	OV34	33 - 34
83630	OV34	33 - 34
83631	OV46	33 - 34
83632	OV48	33 - 34
836356	SCS46	39 to 44
83637	OV46	33 - 34
83640	OV46	33 - 34
83643	OV32	33
83644	OV32	33
83647	OV44	33 - 34
83648	OV32	33
83649	OV32	33
83650	OV44	33 - 34
83651	OV48	33 - 34
836510	SCS46	39 to 44
83654	OV32	33
83661	OV32	33
83669	OV48	33 - 34
83670	OV40	33 - 34
83671	OV34	33 - 34
83673	OV48	33 - 34
83674	OV32	33
83675	OV38	33 - 34

Reference No.	Supco No.	Page	Reference No.	Supco No.	Page	Reference No.	Supco No.	Page	Reference No.	Supco No.	Page
83677	OV50	33	851612	GC185	1 - 3	936164	SM328	10 - 11	9530N1162	GC161	1 - 3
83678	OV32	33	851631	SH443	53 & 54	937001	SCS102	39 to 44	9530N1189	GC185	1 - 3
83680	OV40	33 - 34	851674	SL2697	57 to 60	937071	SL2697	57 to 60	9530N1190	GC185	1 - 3
83681	OV44	33 - 34	851675	SL2697	57 to 60	937072	SL2697	57 to 60	9530N1199	GC185	1 - 3
83682	OV50	33	851778	SH448	53 & 54	937272	GC185	1 - 3	9530N1209	GC185	1 - 3
83686	OV34	33 - 34	851789	SH434	53 & 54	937273	GC185	1 - 3	9530N1221	GC183	1 - 3
83688	OV40	33 - 34	851890	SL2697	57 to 60	937274	GC185	1 - 3	9530N1254	GC183	1 - 3
83689	OV36	33 - 34	851891	SL2697	57 to 60	937276	SM328	10 - 11	9530N1255	GC183	1 - 3
83691	OV36	33 - 34	851931	GC185	1 - 3	937302	SH431	53 & 54	9530N1256	GC183	1 - 3
83692	OV34	33 - 34	851932	GC185	1 - 3	937303	SL2697	57 to 60	9530N1263	GC183	1 - 3
83694	OV44	33 - 34	851933	GC185	1 - 3	937304	SL2697	57 to 60	9530N1303	GC183	1 - 3
83701	OV32	33	8536974	DE702HD	113	93770	LP617	84	9530N567	GC185	1 - 3
83702	OV32	33	8537621	SM343	10 - 11	938117	SM343	10 - 11	9530N568	GC185	1 - 3
83708	OV46	33 - 34	8550	RIM900	20 to 27	938124	SM328	10 - 11	9530N569	GC185	1 - 3
83709	OV38	33 - 34	8557882	DE526	113	938149	SM343	10 - 11	9530N592	GC185	1 - 3
83710	OV34	33 - 34	8562613	LB299	120 to 124	938223	SM328	10 - 11	9530N640	GC161	1 - 3
83711	OV34	33 - 34	86486	SH419	51 & 54	938283	SM328	10 - 11	9530N672	GC185	1 - 3
83713	OV46	33 - 34	86493	GC161	1 - 3	938287	SM343	10 - 11	9530N675	GC185	1 - 3
83714	OV46	33 - 34	86498	SL2690	56, 58 to 60	938292	SM343	10 - 11	9530N678	GC161	1 - 3
83715	OV40	33 - 34	86586	SH457	51 & 54	938296	SM343	10 - 11	9530N712	GC185	1 - 3
83728	OV32	33	86605	SWC58	37, 40 to 44	938372	SM328	10 - 11	9530N757	GC161	1 - 3
83730	OV46	33 - 34	86609	SWC41	37, 40 to 44	939048	SCS115	39 to 44	9530N772	GC185	1 - 3
83736-1	OV44	33 - 34	8667884	DE524	113	939049	SCS102	39 to 44	9530N787	GC185	1 - 3
83737	OV32	33	86689	SGR405	145	939341	SCS116	39 to 44	9530N790	GC185	1 - 3
83741	OV48	33 - 34	86690	SGR405	145	939342	SCS97	39 to 44	9530N792	GC185	1 - 3
83741-1	OV48	33 - 34	867035	SL90	55	939565	SCS105	39 to 44	9530N793	GC183	1 - 3
83743	OV38	33 - 34	868444	DP133	130 to 134	939566	SCS79	39 to 44	9530N805	GC185	1 - 3
83743-1	OV38	33 - 34	868447	DP134	130 to 134	940036	GC185	1 - 3	9530N818	GC161	1 - 3
83746	OV38	33 - 34	868490	DP146	130 to 134	940037	GC185	1 - 3	9530N848	GC185	1 - 3
83746-1	OV38	33 - 34	868491	DP147	130 to 134	940038	GC185	1 - 3	9530N856	GC161	1 - 3
83754	OV46	33 - 34	876369	SP931WP	7	940556	RIM313	20 to 27	9530N861	GC161	1 - 3
83762	OV42	33 - 34	87699	SGR408	145	941506	SM328	10 - 11	9530N875	GC185	1 - 3
83763	OV48	33 - 34	902115	LB233	120 to 124	941547	SM343	10 - 11	9530N888	GC185	1 - 3
83765	OV48	33 - 34	90-290	90290	64	941555	RIM313	20 to 27	9530N900	GC161	1 - 3
83766	OV44	33 - 34	90-291	90291	64	941578	SM328	10 - 11	95405	LB160	120 to 124
83771	OV38	33 - 34	90-292	90292	64	941601	SM328	10 - 11	95440	LP928	84
83772	OV38	33 - 34	90-293	90293	64	941687	SM328	10 - 11	9590	SGR412	145
83774	OV50	33	90-294	90294	64	942268	SCS115	39 to 44	96384	LP332	85
83780	OV32	33	90-295	90295	64	942271	SCS102	39 to 44	96388	LB161	120 to 124
83781	OV32	33	90-340	90340	63	942287	SCS115	39 to 44	96690	LP633	87
83782	OV32	33	90-341	90341	63	942289	SCS102	39 to 44	9724037	LB299	120 to 124
83789	OV44	33 - 34	90-342	90342	63	942299	SCS46	39 to 44	9751123	SGR409	145
8390	RIM2000	20 to 27	90360	90340	63	942758	GC182	1 - 3	9751784	SGR407	145
83907-1	OV48	33 - 34	90362	90341	63	942759	GC182	1 - 3	9753108	SGR412	145
83927	OV48	33 - 34	90364	90342	63	942760	GC182	1 - 3	9782065	SGR412	145
839904	SP695	61	90-370	90370	64	942870	SH447	53 & 54	978212	SM328	10 - 11
839975	SP696	61	90-372	90372	64	942871	SL3084	57 to 60	978331	SH413	53 & 54
850031	GC185	1 - 3	90-374	90374	64	942872	SL3084	57 to 60	978332	SH414	53 & 54
850046	GC185	1 - 3	90-380	90380	64	943116	SCS105	39 to 44	978495	SH429	53 & 54
850115	SL2697	57 to 60	90-382	90382	64	978552	L255	103, 104 & 117	978552	RIM500	20 to 27
850116	SL2697	57 to 60	90-384	90384	64	943117	SCS79	39 to 44	9530N712	GC185	1 - 3
850117	SL2697	57 to 60	911197	LB233	120 to 124	943220	SCS105	39 to 44	9530N757	GC161	1 - 3
850118	SL2697	57 to 60	912361	SP698	61	943221	SCS79	39 to 44	9530N772	GC185	1 - 3
850119	SL2697	57 to 60	912583	SP699	61	944457	SCS116	39 to 44	9530N787	GC185	1 - 3
850120	SL2697	57 to 60	91261	LB160	120 to 124	944470	SCS97	39 to 44	9530N790	GC185	1 - 3
850121	SL2697	57 to 60	9190	SGR412	145	944804	RIM316	20 to 27	9530N792	GC185	1 - 3
850122	SL2697	57 to 60	91938	LP631	84	944925	SCS98	39 to 44	9530N793	GC183	1 - 3
850144	SM328	10 - 11	91939	LP631	84	945061	SCS103	39 to 44	9530N805	GC185	1 - 3
850341	SL2697	57 to 60	92814	LP925	86	9452	SGR412	145	9530N818	GC161	1 - 3
850342	SL2697	57 to 60	934382	GC185	1 - 3	945447	GC185	1 - 3	9530N848	GC185	1 - 3
850447	GC185	1 - 3	934390	SL2697	57 to 60	945456	GC185	1 - 3	9530N856	GC161	1 - 3
850448	GC185	1 - 3	934391	SL2697	57 to 60	945523	SM328	10 - 11	9530N861	GC161	1 - 3
850535	SH433	53 & 54	934424	SL2697	57 to 60	946653	SM343	10 - 11	9530N875	GC185	1 - 3
850607	SL2697	57 to 60	934425	SL2697	57 to 60	946802	SCS115	39 to 44	9530N888	GC185	1 - 3
850669	SL2697	57 to 60	934426	SL2697	57 to 60	946803	SCS102	39 to 44	9530N900	GC161	1 - 3
850754	GC185	1 - 3	934427	SL2697	57 to 60	946890	SCS115	39 to 44	95405	LB160	120 to 124
850881	GC185	1 - 3	934445	SH433	53 & 54	946991	SCS75	39 to 44	95440	LP928	84
850955	GC185	1 - 3	934468	SL2697	57 to 60	946992	SCS115	39 to 44	9590	SGR412	145
850956	GC185	1 - 3	934469	SL2697	57 to 60	946993	SCS75	39 to 44	96384	LP332	85
850957	GC185	1 - 3	93553	LP598	84	946994	SCS102	39 to 44	96388	LB161	120 to 124
851022	SL2697	57 to 60	935761	SCS115	39 to 44	946996	SCS102	39 to 44	96690	LP633	87
85114	LP932	84	935798	SH432	53 & 54	9502	SGR403	145	9724037	LB299	120 to 124
851170	SM343	10 - 11	9360	SGR403	145	95091-1	RIM900	20 to 27	9751123	SGR409	145
851363	SH442	53 & 54	936055	GC185	1 - 3	95092-1	SL7985	24	9751784	SGR407	145
851368	SL2697	57 to 60	936056	GC185	1 - 3	95098-1	RIM900	20 to 27	9753108	SGR412	145
851390	SL2697	57 to 60	936129	SH448	53 & 54	95109-1	RIM900	20 to 27	9782065	SGR412	145
851397	SL2697	57 to 60	936139	SL2697	57 to 60	9530N1075	GC183	1 - 3	978212	SM328	10 - 11
851398	GC185	1 - 3	936140	SL2697	57 to 60	9530N1086	GC161	1 - 3	978331	SH413	53 & 54
851399	GC185	1 - 3	936162	SM343	10 - 11	9530N1159	GC161	1 - 3	978332	SH414	53 & 54
851400	GC185	1 - 3	936163	SM328	10 - 11				978495	SH429	53 & 54

Reference No.	Supco No.	Page	Reference No.	Supco No.	Page	Reference No.	Supco No.	Page	Reference No.	Supco No.	Page
978552	RIM500	20 to 27	A1505508	SGR412	145	C000048731	SL60	55	CC-157	GC183	1 - 3
978553	RIM500	20 to 27	A1505523	SGR403	145	C000069003	SWE58	37, 40 to 44	CC-300	GC116	1 - 3
978556	RIM500	20 to 27	A1505744	SGR412	145	C000069013	SWE58	37, 40 to 44	CC304	SPF17633	6
978559	GC185	1 - 3	A1505745	SGR412	145	C000074249	SL60	55	CC306	SPF17633	6
9790369	SCS112	39 to 44	A1505748	SGR412	145	C000074389	SL60	55	CC309	SPA1403FL	6
9791620	SM346	10 - 11	A1505782	SGR412	145	C000089757	SWE58	37, 40 to 44	CC311	SPF17633	6
9791823	SL7490	57 to 60	A1505783	SGR412	145	C000280162	SWE58	37, 40 to 44	CC315	SPF17633	6
98005652	SGR412	145	A1505784	SGR412	145	C000289135	SL60	55	CC319	SPF17633	6
983644	SCS97	39 to 44	A1505786	SGR403	145	C000289239	SL6792	56, 58 to 60	CC320	SPA1403FL	6
984827	RIM313	20 to 27	A-2	SA2	47	C000289241	SL6792	56, 58 to 60	CC901	SPF17633	6
986016	SCS103	39 to 44	A769-00	SPF17633	6	C000289243	SL6792	56, 58 to 60	CC902	SPF1111F	7
986706	SCS105	39 to 44	AD38	SAD38	38	C000289245	SL60	55	CC903	SPL1111W	7
986707	SCS116	39 to 44	AD67	SAD67	38	C000289247	SL60	55	CC904	SP931WP	7
987036	SCS46	39 to 44	AD68	SAD68	38	C000289249	SL60	55	CC905	SPJ1111AM	7
987151	SCS46	39 to 44	AD69	SAD69	38	C000289313	SL60	55	CC907	K1401GEO	8
987369	SM328	10 - 11	AD70	SAD70	38	C000289315	SL60	55	CC920	SP931WP	7
987613	RIM313	20 to 27	AD71	SAD71	38	C000289316	SL60	55	CC922	A1401ADO	8
989274	GC185	1 - 3	AD72	SAD72	39 to 44	C000289317	SL60	55	CC923	G1401GEO	8
989275	GC185	1 - 3	AD73	SAD73	39 to 44	C000289318	SL60	55	CC924	SPM6823-3	6
989276	GC185	1 - 3	AD76	SAD76	38	C000289319	SL6792	56, 58 to 60	CC925	B1401FO	8
989277	GC185	1 - 3	AD77	SAD77	38	C000289321	SL60	55	CC926	D1401AMO	8
989278	GC185	1 - 3	AD81	SAD81	39 to 44	C000289323	SL60	55	CC927	SPP1401WE	6
989279	GC185	1 - 3	AD82	SAD82	38	C000293907	SL70	55	CC928	SP931WP	7
989319	SL2697	57 to 60	AM29	SAM29	39 to 44	C000293911	SL70	55	CIKHTM-1V	RIM900	20 to 27
989320	SL2697	57 to 60	AM32	SAM32	39 to 44	C000294635	SL70	55	CK177TM	RIM900	20 to 27
989533	GC185	1 - 3	AM33	SAM33	39 to 44	C000298318	SL60	55	CK277SS-1V	RIM900	20 to 27
989534	GC185	1 - 3	AMKIT97	RIM2000	20 to 27	C000460792	SL60	55	CS27	SCS27	39 to 44
989553	SL2697	57 to 60	AP00205001	SGR412	145	C000460793	SL60	55	CS41	SCS79	39 to 44
989565	GC185	1 - 3	AP00205005	SGR412	145	C00048623	SL60	55	CS42	SCS42	39 to 44
989566	GC185	1 - 3	AP00205006	SGR412	145	C00048727	SL60	55	CS44	SCS44	39 to 44
989569	GC185	1 - 3	AP00205011	SGR412	145	C00048729	SL60	55	CS46	SCS46	39 to 44
989570	GC185	1 - 3	AP00205013	SGR412	145	C008871201	SL2690	56, 58 to 60	CS51	SCS98	39 to 44
989571	GC185	1 - 3	AP00205014	SGR409	145	C008871202	SL2690	56, 58 to 60	CS52	SCS115	39 to 44
989572	GC185	1 - 3	AP00205015	SGR412	145	C008871203	SL2690	56, 58 to 60	CS56	SCS116	39 to 44
989574	GC185	1 - 3	AP00235030	SGR403	145	C27987	SM554	16	CS57	SCS102	39 to 44
989578	SL2697	57 to 60	AP205001	SGR412	145	C280162	SWE58	37, 40 to 44	CS58	SCS97	39 to 44
989579	SL2697	57 to 60	AP205002	SGR412	145	C34484	SM556	16	CS59	SCS102	39 to 44
989588	SL2697	57 to 60	AP205004	SGR412	145	C3641505	RIM2000	20 to 27	CS60	SCS115	39 to 44
989589	SL2697	57 to 60	AP205005	SGR412	145	C3641510	RIM2000	20 to 27	D103	SUD103	46
989590	SH443	53 & 54	AP205006	SGR412	145	C3680601	SM337	10 - 11	D109	SUD109	46
989607	SH442	53 & 54	AP205011	SGR412	145	C3684001	SM337	10 - 11	D109B	SUD109	46
989608	SM328	10 - 11	AP205013	SGR412	145	C3686601	SL60	55	D110	SUD110	46
989612	SH434	53 & 54	AP205014	SGR409	145	C3686602	SL60	55	D110B	SUD110	46
989624	SL2697	57 to 60	AP205015	SGR412	145	C3686604	SL60	55	D111	SUD111	46
989625	SL2697	57 to 60	AP205016	SGR412	145	C3686601	SL60	55	D111B	SUD111	46
989626	SL2697	57 to 60	AP235027	SGR403	145	C3686602	SL60	55	D112	SUD112	46
989685	SL2697	57 to 60	AP235030	SGR403	145	C3686604	SL60	55	D113	SUD113	46
989687	SM343	10 - 11	AT201	SET177	109	C52367	SM551	16	D114	SUD114	46
989698	SH429	53 & 54	B1111-00	SPL1111W	7	C63675	SM552	16	D115	SUD115	46
989699	GC185	1 - 3	B13707-38	Q108	67	C65878	SM550	16	D7004106	SC806	7
9900H	9900H	178	B5569-7	SL60	55	C66582	SM553	16	D7004111	SC803	7
9900K	9900K	178	B5611401	SL60	55	C68626	SM140-40A	12	D7004112	SPM6823-3	6
9901K	9901K	178	B56114016	SL60	55	C68627	SM140-40A	12	D7004119	K1401GEO	8
9904H	9904H	178	B5630006	SL60	55	C714087	SH225	49	D700414	SPJ1111AM	7
9904K	9904K	178	B563006	SL60	55	C715824	SH224	49	D70041-4	D1401AMO	8
9906	WF284	30	B5636401	SL50	55	C74265	SH224	49	D7036801	RIM2000	20 to 27
9906H	9906H	178	B5636404	SL50	55	C8713101	SM337	10 - 11	D7036802	RIM2000	20 to 27
9906K	9906K	178	B5638001	SL60	55	C8731901	SL60	55	D7036805	RIM2000	20 to 27
9906P	WF284	30	B5645401	SL90	55	C8731902	SL70	55	D7036814	RIM2000	20 to 27
99080159	SM701	17	B56454-1	SL90	55	C8731903	SL90	55	D7092602Q	SAM29	39 to 44
99080160	SM702	17	B5666201	SL50	55	C8736601	SL90	55	D7092608Q	SAM41	39 to 44
99080166	SM704	17	B5681001	SL60	55	C8736602	SL55	55	D7241409	SM339	10 - 11
99080216	SM705	17	B56810-1	SL60	55	C8736603	SL55	55	D7241412	SM339	10 - 11
99080218	SM700	17	B5688901	SL90	55	C8765001	SL50134	56, 58 to 60	D7261701	RIM2000	20 to 27
99080245	SM703	17	B56889-1	SL90	55	C8765002	SL10010	56, 58 to 60	D7261704	RIM2000	20 to 27
9910	WF284	30	B5752501	SL90	55	C8770402	SL45	55	D7549701	SH437	52 & 54
9910P	WF284	30	B57525-1	SL90	55	C8871201	SL2691	56, 58 to 60	D7549703	SH437	52 & 54
99110630	FB461	18	B5860-1	SL60	55	C8891601	SM365	10 - 11	D7567101	RIM115	20 to 27
99130379H	FB460	18	B931-00	SPA1403FL	6	C8891605	SM365	10 - 11	D7567104	RIM115	20 to 27
9914	WF282	29	BT1256500	Q109	67	C8891606	SM365	10 - 11	D7605106Q	SAM43	39 to 44
9915K	9915K	178	BT1256504	Q103	67	C8898601	SLT55	55	D7605107Q	SAM44	39 to 44
992919	SM328	10 - 11	C000048426	SL60	55	C8898603	SL2691	56, 58 to 60	D7605108Q	SAM33	39 to 44
9956756	SH278	51 & 54	C000048430	SL60	55	C8972002	SL10010	56, 58 to 60	D7605109Q	SAM34	39 to 44
99618	LP730	85	C000048432	SL60	55	C8972003	SL10010	56, 58 to 60	D7605110Q	SAM35	39 to 44
A000254401	SL70	55	C000048621	SL60	55	C8972006	SL10010	56, 58 to 60	D7605115Q	SAM39	39 to 44
A000269903	SL70	55	C000048623	SL60	55	C8972009	SL50	55	D7605116Q	SAM40	39 to 44
A000286103	SL70	55	C000048625	SL60	55	C8978401	SLT55	55	D769-00	SPJ1111AM	7
A00P235030	SGR403	145	C000048727	SL60	55	C8978402	SLT55	55	D7767601	RIM900	20 to 27
A1111-00	SPF1111F	7	C000048728	SL6792	56, 58 to 60	CC-112	GC183	1 - 3	D7790403	K1401GEO	8
A1505507	SGR412	145	C000048729	SL60	55	CC-124	GC161	1 - 3	D7824701	RIM900	20 to 27

Reference No.	Supco No.	Page	Reference No.	Supco No.	Page	Reference No.	Supco No.	Page	Reference No.	Supco No.	Page
D7824702	RIM900	20 to 27	EM750	SM550	16	FPC	SFPC	57	G185196	SL2690	56, 58 to 60
D7824703	RIM900	20 to 27	EM751	SM551	16	FR116	SWC20	37, 40 to 44	G185543-11	GC161	1 - 3
D7824704	RIM900	20 to 27	EM775	SM775	15	FR119	SWC41	37, 40 to 44	G186803-02	SWC21	37, 40 to 44
D7824705	RIM2000	20 to 27	EP8001	9906H	178	FR26	SWC26	37, 40 to 44	G186803-03	SWC20	37, 40 to 44
D7824705Q	RIM900	20 to 27	EP8002	9904K	178	FR90	SWC61	37, 40 to 44	G186803-05	SWC23	37, 40 to 44
D7824706	RIM900	20 to 27	ET101	SET101	97	G000158066	SH445	51 & 54	G186803-11	SWC26	37, 40 to 44
D7824706Q	RIM900	20 to 27	ET102	SET102	91 & 103	G000158289	SM336	9 & 11	G186803-13	SWC22	37, 40 to 44
DE350	SDE350	92, 96, 100, 106 & 113	ET103	SET103	103, 104, 109	G000168579	SM336	9 & 11	G186932-02	SWC58	37, 40 to 44
DE350M	SDE350	92, 96, 100, 106 & 113	ET104	SET104	94, 97, 104 & 109	G000173301	SM336	9 & 11	G186932-03	SWC55	37, 40 to 44
DE358	SDE358	95, 100, 101	ET105	SET105	91, 94, 97, 103 & 104	G158056	SH445	51 & 54	G186932-07	SGI47	37, 40 to 44
DE359	SDE359	92	ET106	SET106	103 & 104	G158066	SH445	51 & 54	G186932-11	SWC41	37, 40 to 44
DST5	SPP5	62	ET108	SET108	103 & 104	G158067	SL2690	56, 58 to 60	G186932-13	SWC12	37, 40 to 44
DST6	SPP6	62	ET109	SET109	91, 103 & 104	G158068	SL2690	56, 58 to 60	G189055-01	SL2690	56, 58 to 60
DST8	SPP8E	62	ET111	SET111	103 & 104	G158289	SM336	9 & 11	G191652	SL2690	56, 58 to 60
E000707807	SFPC	57	ET115	SET115	94 & 104	G158749	SL2690	56, 58 to 60	G191723-13	SWC22	37, 40 to 44
E000707809	SFPC	57	ET117	SET117	97, 104 & 109	G158750	SL2690	56, 58 to 60	G769-00	SPL1111W	7
E000707810	SFPC	57	ET119	SET119	94 & 109	G161588-02	SGI47	37, 40 to 44	GA1005	SA1005	9, 22, 26, & 27
E000707811	SFPC	57	ET121	SET121	91, 97, 103 & 104	G161588-04	SGI46	37, 40 to 44	GC1000	SC1000	5
E1111-00	SPF17633	6	ET129	SET129	91 & 97	G161588-08	SWC21	37, 40 to 44	GC1002	SC1002	5
E769-00	SP931WP	7	ET133	SET133	91, 103 & 104	G161588-09	SWC20	37, 40 to 44	GC157	GC185	1 - 3
E931-00	SP931WP	7	ET137	SET137	97 & 104	G162205-01	GC161	1 - 3	GC170	GC183	1 - 3
EB033ET083	LB299	120 to 124	ET140	SET140	104	G162205-05	GC161	1 - 3	GE 42	SGE517	35, 38, 40 - 44
ECKMF-64	RIM313	20 to 27	ET144	SET144	97 & 109	G162205-06	GC161	1 - 3	GE107	SGE107	38, 40 to 44
ECKMF-94	RIM316	20 to 27	ET145	SET145	103 & 104	G162205-07	GC161	1 - 3	GE108	SGE108	37, 40 to 44
ECKMF-97	RIM316	20 to 27	ET149	SET149	109	G162205-11	GC161	1 - 3	GE109	SGE433	36, 38, 40 - 44
EM241	SM999	12	ET153	SET153	91, 97 & 109	G162205-12	GC161	1 - 3	GE110	SGE110	37, 40 to 44
EM242	SM999	12	ET163	SET163	97, 103 & 104	G162431	SH439	51 & 54	GE111	SGE111	37, 40 to 44
EM244	SM999	12	ET164	SET164	97	G162431-01	SH439	51 & 54	GE112	SGE112	37, 40 to 44
EM245	SM999	12	ET174	SET174	104	G162431-02	SH439	51 & 54	GE116	SGE517	35, 38, 40 - 44
EM247	SM999	12	ET175	SET175	103, 104, 109	G162432-01	SH419	51 & 54	GE117	SGE117	37, 40 to 44
EM248	SM999	12	ET176	SET176	104	G162432-02	SH419	51 & 54	GE118	SGE517	35, 38, 40 - 44
EM249	SM999	12	ET177	SET177	109	G162505-05	GC161	1 - 3	GE119	SGE517	35, 38, 40 - 44
EM305	SM305	9 & 11	ET182	SET182	91	G162667-01	GC161	1 - 3	GE125	SGE125	37, 40 to 44
EM316	SM316	9 & 11	ET183	SET183	91	G162667-05	GC161	1 - 3	GE126	SGE126	37, 40 to 44
EM319	SM319	9 & 11	ET184	SET184	109	G162667-06	GC161	1 - 3	GE127	SGE127	37, 40 to 44
EM327	SM327	10 - 11	ET187	SET187	97	G162667-10	GC161	1 - 3	GE128	SGE301	37, 40 to 44
EM328	SM328	10 - 11	ET401	SET401	97 & 109	G162667-11	GC161	1 - 3	GE129	SGE303	37, 40 to 44
EM329	SM329	10 - 11	ET402	SET402	109	G162667-12	GC161	1 - 3	GE130	SGE284	37, 40 to 44
EM332	SM332	9 & 11	ET403	SET403	104	G162677-05	GC161	1 - 3	GE132	SGE286	37, 40 to 44
EM333	SM333	9 & 11	ET404	SET404	104	G162690	SL2690	56, 58 to 60	GE133	SGE318	37, 40 to 44
EM334	SM334	9 & 11	ET405	SET405	104	G162690-01	SL2690	56, 58 to 60	GE134	SGE309	37, 40 to 44
EM335	SM335	9 & 11	ET800	SET800	97	G162697-01	SL2690	56, 58 to 60	GE135	SGE319	37, 40 to 44
EM336	SM336	9 & 11	F000112205	SL2690	56, 58 to 60	G162705	SM336	9 & 11	GE136	SGE390	37, 40 to 44
EM337	SM337	10 - 11	F112205	SL2205	56, 58 to 60	G163939	SM336	9 & 11	GE137	SGE433	36, 38, 40 - 44
EM338	SM338	9 & 11	F128154	SL2690	56, 58 to 60	G165335	SM336	9 & 11	GE138	SGE287	37, 40 to 44
EM339	SM339	10 - 11	F131324	LB113	120 to 124	G166153	SL2690	56, 58 to 60	GE139	SGE312	37, 40 to 44
EM342	SM342	10 - 11	F131602	LB113	120 to 124	G166157	SL2690	56, 58 to 60	GE141	SGE311	37, 40 to 44
EM343	SM343	10 - 11	F131654	LB210	120 to 124	G168579	SM336	9 & 11	GE142	SGE422	36, 38, 40 - 44
EM344	SM344	9 & 11	F132206	SET119	94 & 109	G168797	SM336	9 & 11	GE143	SGE517	35, 38, 40 - 44
EM550	SM550	16	F133058	LP118	78	G168930-02	SWC21	37, 40 to 44	GE144	SGE517	35, 38, 40 - 44
EM551	SM551	16	F133171	LB113	120 to 124	G168930-03	SWC20	37, 40 to 44	GE151	SGE433	36, 38, 40 - 44
EM552	SM552	16	F133850	DE787	96	G168930-05	SWC23	37, 40 to 44	GE153	SGE295	37, 40 to 44
EM553	SM553	16	F133850-000	DE787	96	G168930-07	SGI47	37, 40 to 44	GE155	SGE300	37, 40 to 44
EM554	SM554	16	F139318	LB111	120 to 124	G168930-09	SGI46	37, 40 to 44	GE156	SGE302	37, 40 to 44
EM555	SM555	16	F141297	LB210	120 to 124	G171810-01	GC161	1 - 3	GE161	SGE421	36, 37, 40 - 44
EM556	SM556	16	F141724	DE695	96	G173301	SM336	9 & 11	GE162	SGE432	36, 38, 40 - 44
EM670	SM670	15	F141888	DE694	96	G175324-02	SWC21	37, 40 to 44	GE164	SGE433	36, 38, 40 - 44
EM671	SM671	15	F30191	LD225	94 & 117	G175324-03	SWC20	37, 40 to 44	GE165	SGE433	36, 38, 40 - 44
EM672	SM672	15	F32148	LD130	91, 94, 97, 103 & 104	G175324-05	SWC23	37, 40 to 44	GE166	SGE433	36, 38, 40 - 44
EM673	SM673	15	F36589	L205	94, 97, 103 & 117	G175324-07	SGI47	37, 40 to 44	GE167	SGE433	36, 38, 40 - 44
EM674	SM674	15	F63510	LB212	120 to 124	G175324-09	SGI46	37, 40 to 44	GE168	SGE433	36, 38, 40 - 44
EM675	SM675	15	F65802-1	L150	91, 94, 103, 104 & 117	G175324-11	SWC26	37, 40 to 44	GE169	SGE433	36, 38, 40 - 44
EM676	SM676	15	F66908	L130	94, 97, 103, 104 & 117	G175324-13	SWC22	37, 40 to 44	GE170	SGE433	36, 38, 40 - 44
EM678	SM678	15	F73382	LB210	120 to 124	G176117	SM336	9 & 11	GE175	SGE432	36, 38, 40 - 44
EM679	SM679	15	F76613	LD200	94 & 117	G176807-01	SH457	51 & 54	GE177	SGE432	36, 38, 40 - 44
EM680	SM680	15	F769-00	SPF1111F	7	G178425-01	SH439	51 & 54	GE437	SGE437	38, 40 to 44
EM681	SM681	15	F78448	LB291	120 to 124	G178425-02	SH439	51 & 54	GE446	SGE446	38, 40 to 44
EM682	SM682	15	F78794	LB113	120 to 124	G178481	SM336	9 & 11	GE449	SGE449	38, 40 to 44
EM683	SM683	15	F79198	L205	94, 97, 103 & 117	G180547-02	SWC58	37, 40 to 44	GE450	SGE450	38, 40 to 44
EM684	SM684	15	F87333	SL50	55	G180547-03	SWC55	37, 40 to 44	GE464	SGE464	38, 40 to 44
EM685	SM685	15	F88366	SL60	55	G180547-07	SGI47	37, 40 to 44	GE485	SGE485	38, 40 to 44
EM686	SM686	15	FB718 GEM	FB718G	18	G180547-11	SWC41	37, 40 to 44	GE52	SGE517	35, 38, 40 - 44
EM687	SM687	15				G180547-13	SWC12	37, 40 to 44	GE5231	SGE5231	38, 40 to 44
EM688	SM688	15				G180551-04	SWC49	37, 40 to 44	GE5232	SGE5232	38, 40 to 44
EM690C	SM690C	15							GE55	SGE517	35, 38, 40 - 44
EM691	SM691	15							GE558	SGE558	38, 40 to 44
EM692	SM692	15							GE57	SGE517	35, 38, 40 - 44
									GE76	SGE517	35, 38, 40 - 44
									GE78	SGE517	35, 38, 40 - 44
									GE79	SGE517	35, 38, 40 - 44

Reference No.	Supco No.	Page
GE81	SGE517	35, 38, 40- 44
GE82	SGE517	35, 38, 40 - 44
GE88	SGE517	35, 38, 40 - 44
GH201	SH201	48
GH202	SH202	48
GH203	SH203	48
GH204	SH204	48
GH205	SH205	48
GH206	SH206	48
GH207	SH207	48
GH221	SH221	49
GH222	SH222	49
GH223	SH223	49
GH224	SH224	49
GH225	SH225	49
GH226	SH226	49
GH251	SH251	49
GH261	SH261	50 & 54
GH263	SH263	50 & 54
GH264	SH264	50 & 54
GH265	SH265	50 & 54
GH266	SH266	50 & 54
GH267	SH267	50 & 54
GH270	SH270	50 & 54
GH271	SH271	50 & 54
GH273	SH273	50 & 54
GH274	SH274	50 & 54
GH276	SH276	50 & 54
GH277	SH277	50, 52, & 54
GH278	SH278	51 & 54
GH281	SH281	49
GH282	SH282	49
GH283	SH283	49
GH284	SH284	49
GH301	SH301	51 & 54
GH302	SH302	51 & 54
GH303	SH303	51 & 54
GH305	SH305	51 & 54
GH306	SH306	51 & 54
GH307	SH307	51 & 54
GH308	SH308	52 & 54
GH309	SH309	52 & 54
GH310	SH310	52 & 54
GH311	SH311	52 & 54
GH319	SH319	52 & 54
GH320	SH320	52 & 54
GH326	SH326	52 & 54
GH374	SH374	52 & 54
GH413	SH413	53 & 54
GH414	SH414	53 & 54
GH415	SH415	51 & 54
GH419	SH419	51 & 54
GH429	SH429	53 & 54
GH431	SH431	53 & 54
GH432	SH432	53 & 54
GH433	SH433	53 & 54
GH434	SH434	53 & 54
GH437	SH437	52 & 54
GH439	SH439	51 & 54
GH442	SH442	53 & 54
GH443	SH443	53 & 54
GH447	SH447	53 & 54
GH448	SH448	53 & 54
GH500	SH500	49
GH502	SH502	49
GH503	SH503	49
GH504	SH504	49
GH505	SH505	49
GI43	SIGI47	37, 40 to 44
GI44	SIGI46	37, 40 to 44
GIKSS	RIM900	20 to 27
GIKTM	RIM900	20 to 27
GL2205	SL2205	56, 58 to 60
GL243	SL243	55
GL245	SL245	55
GL247	SL247	55
GL249	SL249	55
GL2690	SL2690	56, 58 to 60
GL2691	SL2691	56, 58 to 60
GL2697	SL2697	57 to 60

Reference No.	Supco No.	Page
GL3084	SL3084	57 to 60
GL45	SL45	55
GL50	SL50	55
GL5022	SL5022	24
GL55	SL55	55
GL5708	SL5708	57 to 60
GL5709	SL5709	57 to 60
GL5844	SL5844	24
GL60	SL60	55
GL6792	SL6792	56, 58 to 60
GL70	SL70	55
GL7985	SL7985	24
GL80	SL80	55
GL8366	SL8366	56, 58 to 60
GL8509	SL8509	56, 58 to 60
GL8510	SL8510	56, 58 to 60
GL8513	SL8513	56, 58 to 60
GL8515	SL8515	56, 58 to 60
GL8517	SL8517	56, 58 to 60
GL8519	SL8519	56, 58 to 60
GL8528	SL8528	56, 58 to 60
GL90	SL90	55
GLT45	SLT45	55 & 56
GLT50	SLT50	55
GLT55	SLT55	55
GLT60	SLT60	55
GLT70	SLT70	55
GLT80	SLT80	55
GM142027	SGR403	145
GP1	A1401ADO	8
GP11	SP931WP	7
GP18	K1401GEO	8
GP19	D1401AMO	8
GP2	G1401GEO	8
GP20	SP931WP	7
GP21	SPA1403FL	6
GP3	SPL1111W	7
GP4	B1401FO	8
GP6	SPA1403FL	6
GP9	SPM6823-3	6
GR401	SGR401	145
GR402	SGR402	145
GR403	SGR403	145
GR404	SGR404	145
GR405	SGR405	145
GR407	SGR407	145
GR408	SGR408	145
GR409	SGR409	145
GR410	SGR410	145
GR411	SGR411	145
GR412	SGR412	145
GR413	SGR413	145
GRG1051	1051	35
GRG1051100	1051100	35
GRG105150	105150	35
GS101	Q101	67
GS102	Q102	67
GS103	Q103	67
GS104	Q104	67
GS105	Q105	67
GS106	Q106	67
GS107	Q107	67
GS108	Q108	67
GSWF	WF282	29
GWW-151	GWW151	78, 80, 81, 83, 87
HF110	SHF110	115
HF110DC	SHF110DC	115
HF120	SHF120	115
HF130	SHF130	104 & 115
HF140	SHF140	97 & 115
HF150	SHF150	115
HF160	SHF160	103 & 115
HF200	SHF200	115
HF90	SHF90	115
HL120	SHL120	115
HL140	SHL140	115
HL150	SHL150	115
HL160	SHL160	115
HL170	SHL170	115

Reference No.	Supco No.	Page
HL180	SHL180	115
HL190	SHL190	115
HL200	SHL200	115
HL210	SHL210	115
HL230	SHL230	115
HL250	SHL250	115
HL300	SHL300	115
HMG-9012	RIM900	20 to 27
HMG-9013	RIM900	20 to 27
HMG-9018	RIM900	20 to 27
HMG-9020	RIM900	20 to 27
HP103	3803FE	90
HP104	3804FE	90
HP105	3805FE	90
HP106	3806FE	90
HP108	3808FE	90
HP110	3810FE	90
HP112	3812FE	90
HP115	3815FE	90
HP203	3803FF	90
HP204	3804FF	90
HP205	3805FF	90
HP206	3806FF	90
HP208	3808FF	90
HP210	3810FF	90
HP212	3812FF	90
HP215	3815FF	90
HP303	3803MF	90
HP304	3804MF	90
HP305	3805MF	90
HP306	3806MF	90
HP406	SSD6	88 & 89
HP408	SSD8	78, 88, & 89
HP416	SSD6	88 & 89
HP418	SSD8	78, 88, & 89
HS16001	HS16001	175
HS18004	HS18004	175
HS20004	HS20004	174
HS20016	HS20016	174
HS20128	HS20128	174
HS21004	HS21004	174
HS21016	HS21016	174
HS21128	HS21128	174
HS22008	HS22008	174
HS22032	HS22032	174
HS22128	HS22128	174
HS23008	HS23008	174
HS23032	HS23032	174
HS23128	HS23128	174
HS24001	HS24001	175
HS24010	HS24010	175
HS24128	HS24128	175
HS24A34-1	Q101	67
HS24A34-14	Q107	67
HS24A34-2	Q102	67
HS24A34-3	Q103	67
HS24A34-4	Q104	67
HS24A34-5	Q105	67
HS24A34-6	Q106	67
HS26004	HS26004	174
HS26016	HS26016	174
HS26128	HS26128	174
HS40008	HS40008	177
HS40128	HS40128	177
HS410	RCO410	31
HS41008	HS41008	177
HS41128	HS41128	177
HS50004	HS50004	177
HS51032	HS51032	175
HS51128	HS51128	175
HS52032	HS52032	177
HS52105	HS52105	177
HS52115	HS52115	177
HS52128	HS52128	177
HS55032	HS55032	175
HS55128	HS55128	175
HS56011	HS56011	176
HS57014	HS57014	176
HS58128	HS58128	176
HS58520	HS58520	176

Reference No.	Supco No.	Page
HS59128	HS59128	176
HS59520	HS59520	177
HS600	SPP5	62
HS650	SPP6	62
HS810	RCO810	31
HS820	RCO820	31
HSINJ001	HSINJ001	174
IC1	ICG1	31
IC11B	RIM115	20 to 27
IC13	RO41	31
IC2	ICG-220	31
IC23	RO42	31
IC25	RO62	31
IC3	RIM115	20 to 27
IC31	ICG1	31
IC32	ICG-220	31
IC3H	RIM115	20 to 27
IC3Q	RIM115	20 to 27
IC3K	RIM115	20 to 27
IC4	RIM117	20 to 27
IC41	RO41	31
IC42	RO42	31
IC4N	RIM117	20 to 27
IC4Q	RIM943	20 to 27
IC4R	RIM117	20 to 27
IC6	RIM400	20 to 27
IC7	RIM400	20 to 27
IC8	RIM115	20 to 27
IC81	RO81	31
IC82	RO82	31
ICM850	SPP5E	62
ICM860	SPP6E	62
ICP41	RO41	31
IGN-1	SGR407	145
IGN-2	SGR409	145
IGN-3	SGR410	145
IGN-4	SGR411	145
IGN-5	SGR412	145
IGN-6	SGR408	145
IGN-7	SGR407	145
IGN-8	SGR412	145
IK1ANS	RIM900	20 to 27
IK1ANT	RIM900	20 to 27
IK1FNS	RIM900	20 to 27
IK1FNT	RIM900	20 to 27
IK1HNS	RIM900	20 to 27
IK1HNT	RIM900	20 to 27
IK-4	RIM400	20 to 27
IK-7	RIM400	20 to 27
IK76DP	RIM900	20 to 27
IK76DP-1	RIM900	20 to 27
IK78NS	RIM900	20 to 27
IK78NT	RIM900	20 to 27
IK-8	RIM400	20 to 27
IK-9	RIM115	20 to 27
IKIANT	RIM900	20 to 27
IM-1	RIM2000	20 to 27
IM115	RIM115	20 to 27
IM1R	RIM2000	20 to 27
IM-2	RIM2000	20 to 27
IM2R	RIM2000	20 to 27
IM-3	RIM2000	20 to 27
IM34	RIM400	20 to 27
IM3R	RIM2000	20 to 27
IM-4	RIM2000	20 to 27
IM-6	RIM2000	20 to 27
IMG3	RIM300	20 to 27
IMKIT	RIM900	20 to 27
JS2	RIM2000	20 to 27
JS3	RIM2000	20 to 27
K001205008	SKL36	37, 40 to 44
K1025647	L125	94, 97, 103, 104 & 117
K1027198	L225	91, 94, 97, 103, 104 & 117
K1030890	L180-40	94, 97, 103, 104 & 117
K1031140	SET119	94 & 109
K1034218	SET105	91, 94, 97, 103 & 104

Reference No.	Supco No.	Page	Reference No.	Supco No.	Page	Reference No.	Supco No.	Page	Reference No.	Supco No.	Page
K1035672	LD130	91, 94, 97, 103 & 104	M400947	DE947	93	PR067	9067	63	R0710221	SGR408	145
K1035674	L250	94, 104 & 117	M401182	LB288	120 to 124	PR068	9068	63	R0950064	IMM8366	20 to 27
K1036048	L130	94, 97, 103, 104 & 117	M401254	SET105	91, 94, 97, 103 & 104	Q000198333	SGR403	145	R162667-11	GC161	1 - 3
K109	SM555	16	M401255	SET129	91 & 97	Q000198338	SGR412	145	R186932-02	SWC58	37, 40 to 44
K111	SM550	16	M401256	L175	91, 97 & 117	Q000198339	SGR412	145	R186932-03	SWC55	37, 40 to 44
K1111-00	SPJ1111AM	7	M401257	L200	91, 94, 103, 104 & 117	Q000198344	SGR412	145	R4222B1082	90291	64
K112	SM551	16	M401258	L225	91, 94, 97, 103, 104, 117	Q12967	LB151	120 to 124	R4222B1090	90292	64
K113	SM552	16	M402366	DE353	93, 96, 101, 106 & 111	Q12969	LB151	120 to 124	R4222D1013	90341	63
K115	SM553	16	M402742	DE353	93, 96, 101, 106 & 111	Q12970	LB150	120 to 124	R4222N1021	90342	63
K1167822	SL50	55	M402743	SDE350	92, 96, 100, 106 & 113	Q181621	LB152	120 to 124	R8222B1067	90290	64
K1201772	SKL36	37, 40 to 44	M406119	ES16806	83, 93, 95, 100, 101, 108 & 119	Q181622	LB111	120 to 124	R8222D1014	90340	63
K1204667	SM336	9 & 11	M4D9433	SET107	91	Q181623	LB111	120 to 124	R9900489	SET200	91 & 109
K1205008	SKL36	37, 40 to 44	M900947	DE947	93	Q181624	LB152	120 to 124	RA262	SGR402	145
K1227771	SL50	55	MAXP5	SPP5	62	Q181625	LB111	120 to 124	RA264	SGR402	145
K1228589	SL50	55	MAXP6	SPP6	62	Q607581	LB295	120 to 124	RA270	SGR401	145
K1229270	SL60	55	MGIMKS	RIM900	20 to 27	Q62142	LB160	120 to 124	RA271	SGR402	145
K1229271	SL60	55	MGIMKT	RIM900	20 to 27	Q62144	LB154	120 to 124	RA272	SGR403	145
K1230220	SL60	55	MHIK7989	RIM900	20 to 27	Q62148	LB160	120 to 124	RA273	SGR404	145
K1231024	SL60	55	MIP85S	RIM900	20 to 27	Q62149	LB151	120 to 124	RA43714-1	RIM900	20 to 27
K1231538	SL60	55	MIP85T	RIM900	20 to 27	Q62152	LB154	120 to 124	RA-43714-1	RIM900	20 to 27
K1231624	SL60	55	MIP85T-2	RIM900	20 to 27	Q622032	DE335	95	RA43714-10	RIM900	20 to 27
K1231688	SL60	55	MP1	SPP9E	62	Q622034	DE336	95	RA-43714-10	RIM900	20 to 27
K1301037	SGR401	145	MP12MA	SU303	126	Q622451	LB155	120 to 124	RA43714-11	RIM900	20 to 27
K1321037	SGR401	145	MP12YA	SU203	125	Q622601	DE382AWR	93, 94, 95, 98, 105, 109	RA-43714-11	RIM900	20 to 27
K1321263	SGR401	145	MP15MA	SU305	126	Q622602	DE382BWR	93, 94, 95, 98, 105, 109	RA43714-12	RIM900	20 to 27
K15017	DP112	130 to 134	MP15YA	SU204	125	Q63259	LB152	120 to 124	RA-43714-12	RIM900	20 to 27
K15018	DP113	130 to 134	MP21MA	SU304	126	Q63805	LB260	120 to 124	RA43714-14	RIM900	20 to 27
K5894	SM140-40A	12	MP21YA	SU205	125	Q63806	LB260	120 to 124	RA-43714-14	RIM900	20 to 27
K5895	SM140-40A	12	MP26MA	SU306	126	Q63807	LB260	120 to 124	RA43714-2	RIM900	20 to 27
KA12	KA12	178	MP26YA	SU206	125	Q63808	LB260	120 to 124	RA-43714-2	RIM900	20 to 27
KA36	KA36	178	MIP351	OV32	33	Q63809	LB260	120 to 124	RA43714-4	RIM900	20 to 27
KIMF81	RIM900	20 to 27	MIP352	OV34	33 - 34	Q63810	LB260	120 to 124	RA-43714-4	RIM900	20 to 27
KIMS8	RIM900	20 to 27	MIP354	OV36	33 - 34	Q63811	LB260	120 to 124	RA43714-6	RIM900	20 to 27
KL36	SKL36	37, 40 to 44	MIP355	OV36	33 - 34	Q63812	LB260	120 to 124	RA-43714-6	RIM900	20 to 27
KS1	SPP10E	62	MIP357	OV36	33 - 34	R0000209	RIM2000	20 to 27	RA43714-8	RIM900	20 to 27
KS8	SPP6E	62	MIP358	OV34	33 - 34	R000900749	SL2690	56, 58 to 60	RA-43714-8	RIM900	20 to 27
L36-101	Q107	67	MIP359	OV32	33	R000901098	SWC12	37, 40 to 44	RA43714-9	RIM900	20 to 27
L36-475	Q101	67	MP360	OV40	33 - 34	R000901154	SWC41	37, 40 to 44	RA-43714-9	RIM900	20 to 27
L36-476	Q102	67	MP361	OV44	33 - 34	R009000103	SWC20	37, 40 to 44	RA43990-1	SM335	9 & 11
L36-477	Q103	67	MP362	OV50	33	R009000110	SWC21	37, 40 to 44	RA95019-1	RIM900	20 to 27
L36-478	Q104	67	MSE1	RIM2000	20 to 27	R0130847	RIM2000	20 to 27	RA95020-1	RIM900	20 to 27
L36-479	Q105	67	N316T030P01	SGR403	145	R0131577	D1401AMO	8	RA95043-1	SH311	52 & 54
L36-480	Q106	67	NISS	RIM900	20 to 27	R0154025	RIM900	20 to 27	RC026	SGR405	145
LA-1003	DE902M	96, 99, 107 & 110	NITM	RIM900	20 to 27	R0156628	IMM8366	20 to 27	RC101	WF284	30
LA-1005	ES16600	76, 81, 107 & 119	NR001	SGR408	145	R0156629	RIM900	20 to 27	RC200	WF284	30
LA-1006	DE777	107	NR002	SGR410	145	R0156669	RIM900	20 to 27	RC32-1561M	GC193	1 - 3
LA-1007	DE690	107	NR004	SGR409	145	R0156806	RIM900	20 to 27	RF100	WF284	30
LA-1008	DE696	108	NR005	SGR411	145	R0156806	RIM115	20 to 27	RF200	WF284	30
LA101	HM101	90	NR006	SGR407	145	R0156806	RIM115	20 to 27	RG100	WF284	30
LA103	HL103	90	NR018	SGR412	145	R0157335	SH416	53 & 54	RIM1000	RIM2000	20 to 27
LA-1035	SET195	103, 104 & 109	NR020	SGR412	145	R0157343	SL60	55	RIM200	RIM116	20 to 27
LA-1044	DE148	108	NR023	SGR412	145	R0161012	SLT55	55	RIM321	RIM117	20 to 27
LA1053	SET405	104	NR029	SGR412	145	R0161018	SL5844	24	RIM550	RIM500	20 to 27
LA182	GNBA	80, 87, & 90	P205001	SGR412	145	R0161023	SL5844	24	RIM650	RIM117	20 to 27
LB242	LB217	120 to 124	P205005	SGR412	145	R0161036	SL5844	24	RKE	RIM900	20 to 27
LP510G	LP510	79	P205006	SGR412	145	R0161056	SFPC	57	RP21225G	RP21225GB	142
LT001	6S6	150	P205013	SGR412	145	R0161059	RIM900	20 to 27	RP21250G	RP21250GB	142
LT002	6S6DC	150	P205014	SGR409	145	R0161060	SL7985	24	RP21425G	RP21425GB	142
LT003	7C7	150	P205015	SGR412	145	R0161061	RIM900	20 to 27	RP21450G	RP21450GB	142
LT004	10C7	83, 93, & 150	P205016	SGR412	145	R0161086	SL2690	56, 58 to 60	RP2512P	RP2512G	142
LT005	10C7DC	150	P205023	SGR409	145	R0161087	SL50	55	RP2514P	RP2514G	142
LT006	15T7C	150	P205034	SGR412	145	R0161088	SL50	55	RP5012P	RP5012G	142
LT007	15T7DC	150	P205036	SGR412	145	R0161088	RIM900	20 to 27	RP5014P	RP5014G	142
LT008	25T61/2	150	P235030	SGR403	145	R0167202	IMM8366	20 to 27	S5305510264	C25D	28
LT009	25T61/2DC	150	PB040001	SGR412	145	R0167203	IMM8366	20 to 27	SM241	SM999	12
LT010	25T8N	150	PH52	SPH52	37, 40 to 44	R0168026	G1401GEO	8	SM242	SM999	12
LT011	25T8DC	150	PH53	SPH53	37, 40 to 44	R0168027	K1401GEO	8	SM244	SM999	12
LT012	40A15	150	PR063	9063	63	R0168028	SC801	7	SM245	SM999	12
LT013	40T61/2	150	PR064	9064	63	R0175020	RIM117	20 to 27	SM247	SM999	12
LT014	40T10	150	PR065	9065	63	R0175021	RIM115	20 to 27	SM248	SM999	12
LT018	40T10IF	150	PR066	9066	63	R0183094	GA31	25	SM249	SM999	12
M0307601	SM337	10 - 11				R0194462	RIM900	20 to 27	SP12MA	SU301	126
M2041A	SGR412	145				R0194666	IMM8366	20 to 27	SP12YA	SU201	125
M40001	ES16301	82, 92, & 118				R0194666	IMM8366	20 to 27	SP21MA	SU302	126
M400607	LB288	120 to 124				R0606524	LB270	120 to 124	SP21YA	SU202	125
M400945	ES15807	93 & 118				R0606539	LB142	120 to 124	ST128	LB288	120 to 124
						R0606549	LB254	120 to 124	SU203SR	SU203	125
						R0710104	SGR408	145	SU204SR	SU204	125
						R0710131	SGR408	145	SU205SR	SU205	125
						R0710132	SGR408	145	SU206SR	SU206	125

Reference No.	Supco No.	Page
SU303SR	SU303	126
SU304SR	SU304	126
SU305SR	SU305	126
SU306SR	SU306	126
T183-56	ES16301	82, 92, & 118
TDR10	Q101	67
TDR15	Q102	67
TDR20	Q103	67
TDR25	Q104	67
TDR30	Q105	67
TDR35	Q106	67
TO5	SPP8E	62
TT128	LB288	120 to 124
UKI1000AXX	RIM2000	20 to 27
UKI1500AXX	RIM2000	20 to 27
UKKIT1	RIM300	20 to 27
UKKIT2	RIM300	20 to 27
UKKIT3S	RIM300	20 to 27
UKKIT4	RIM300	20 to 27
UKKIT5	RIM300	20 to 27
UNIVM98	RIM116	20 to 27
UX-2001-00	SP931WP	7
VFM100	SM550	16
VFM101	SM551	16
VFM103	SM552	16
VFM104	SM553	16
VFM105	SM554	16
VFM106	SM555	16
W2656D44H02	SL6792	56, 58 to 60
W2656D44H03	SL6792	56, 58 to 60
W2656D44H04	SL50	55
W2656D44H05	SL6792	56, 58 to 60
W2656D44H09	SL50	55
WB00X6609	SGR409	145
WB02X10016	SGR415	145
WB02X4221	SGR409	145
WB02X4306	SGR409	145
WB02X4309	SGR409	145
WB02X4385	SGR410	145
WB02X4528	SGR412	145
WB02X4600	SGR412	145
WB02X4752	SGR409	145
WB02X4827	SGR407	145
WB13K1	SGR403	145
WB13K12	SGR412	145
WB13K13	SGR412	145
WB13K14	SGR412	145
WB13K21	SGR412	145
WB13K3	SGR403	145
WB13K4	SGR403	145
WB13T10001	SGR412	145
WB17X210	RR105	129
WB17X5051	RR122	129
WB22X105	SGR402	145
WB2X10016	SGR412	145
WB2X4221	SGR409	145
WB2X4306	SGR409	145
WB2X4309	SGR409	145
WB2X4385	SGR410	145
WB2X4528	SGR412	145
WB2X4600	SGR412	145
WB2X4752	SGR409	145
WB2X4827	SGR407	145
WB2X5041	RR382	129
WB2X5195	SGR403	145
WB2X5699	RK699	149
WB2X7954	SGR407	145
WB2X8212	SGR412	145
WB2X8215	SGR412	145
WB2X9154	SGR403	145
WB2X9697	SGR412	145
WB2X9998	SGR412	145
WB30M1	SU121	128
WB30M2	SU122	128
WB30T10074	SU151	128
WB30T10078	SU150	128
WB30X218	SU117	127
WB30X219	SU118	128
WB30X341	SU119	128
WB30X342	SU120	127

Reference No.	Supco No.	Page
WB30X348	SU348	127
WB30X354	SU116	127
WB30X356	SU115	127
WB30X359	SU359	127
WB31K5024	DP166	130 to 134
WB31K5025	DP167	130 to 134
WB31K5044	DP131	130 to 134
WB31K5046	DP132	130 to 134
WB31K5047	DP147	130 to 134
WB31K5049	DP132	130 to 134
WB31M1	DP112	130 to 134
WB31M15	DP165	130 to 134
WB31M16	DP164	130 to 134
WB31M19	DP365	130 to 134
WB31M2	DP113	130 to 134
WB31M20	DP364	130 to 134
WB31T10010	DP164	130 to 134
WB31T10011	DP165	130 to 134
WB31T10014	DP364	130 to 134
WB31T10015	DP365	130 to 134
WB31X5010	DP101	130 to 134
WB31X5011	DP102	130 to 134
WB31X5013	DP104	130 to 134
WB31X5014	DP105	130 to 134
WB31X5045	DP146	130 to 134
WB31X5047	DP147	130 to 134
WB32X10012	DP114	130 to 134
WB32X10013	DP115	130 to 134
WB32X10014	DP165	130 to 134
WB32X10015	DP164	130 to 134
WB32X10017	DP112	130 to 134
WB32X10018	DP113	130 to 134
WB32X102	DP158	130 to 134
WB32X103	DP145	130 to 134
WB32X104	DP144	130 to 134
WB32X106	DP113	130 to 134
WB32X107	DP112	130 to 134
WB32X5024	DP160	130 to 134
WB32X5036	DP117	130 to 134
WB32X5045	DP116	130 to 134
WB32X5051	DP144	130 to 134
WB32X5052	DP145	130 to 134
WB32X5069	DP365	130 to 134
WB32X5070	DP364	130 to 134
WB32X5075	DP164	130 to 134
WB32X5076	DP165	130 to 134
WB32X84	DP103	130 to 134
WB32X90	DP159	130 to 134
WC12	SWC12	37, 40 to 44
WC460792	SL6792	56, 58 to 60
WD12X5028	DW144	74
WD19X10032	DW105	74 & 75
WD19X62	DW105	74 & 75
WD1X1147	DW145	73
WD1X1154	DW146	73
WD1X1308	DW150	73
WD1X5488	DW148	73
WD22X110	DW151	74
WD22X114	DW111	75
WD22X120	DW112	75
WD22X124	DW152	75
WD22X71	DW113	75
WD26X10003	DW10013	75
WD26X10007	DW10013	75
WD26X10011	DW10013	75
WD26X10013	DW10013	75
WD26X77	DW10013	75
WD3X749	DW154	74
WD6X130	ES16300	73, 76, 82, 118
WD6X183	DW440	74
WD7X14	DW309	74
WD8X181	DW155	74
WD8X227	DW156	74
WD8X228	DW157	74
WE01X10023	DE902M	96, 99, 107 & 110
WE01X10030	DE410	99
WE01X10032	DE410	99
WE01X10033	LP217	79 & 99
WE01X10052	DE410	99

Reference No.	Supco No.	Page
WE01X10122	DE905	99 & 112
WE01X10152	DE410	99
WE01X10156	LP217	79 & 99
WE03X10001	DE790	96 & 100
WE03X10002	DE727	95
WE04X10002	FL260	94, 97, & 116
WE04X10004	DE382WR	94, 96, 98, 105 & 109
WE04X10018	L14515W	94, 97 & 116
WE04X10020	DE382WR	94, 96, 98, 105 & 109
WE04X10021	DE353	93, 96, 101, 106 & 111
WE04X10028	L14515W	94, 97 & 116
WE04X10031	DE382WR	94, 96, 98, 105 & 109
WE04X10034	ES16806	83, 93, 95, 100, 101, 108 & 119
WE04X10046	ES16806	83, 93, 95, 100, 101, 108 & 119
WE04X10048	DE382WR	94, 96, 98, 105 & 109
WE04X10055	L180-20	97 & 117
WE04X10099	L13515W	94, 97 & 116
WE04X10116	SDE358	95, 100, 101
WE04X10128	SDE358	95, 100, 101
WE04X10132	SDE358	95, 100, 101
WE11M21C	DE334	101
WE11X10004	DE838	102 & 111
WE11X10009	25M01A-100	92 to 110
WE11X203	DE333	101
WE11X203C	DE333	101
WE11X260	DE315D	101
WE11X260C	DE315D	101
WE11X261	DE316D	101
WE11X261C	DE316D	101
WE11X60	DE315	101
WE11X60C	DE315	101
WE11X61	DE316	101
WE11X61C	DE316	101
WE11X90	DE337	101
WE11X90C	DE337	101
WE11X99	DE338	95 & 101
WE11X99C	DE338	95 & 101
WE12M22	LB298	120 to 124
WE12M24	LB278	120 to 124
WE12M8	DE412	102
WE12M9	LB278	120 to 124
WE12X10001	LB216	120 to 124
WE12X10009	DE411	102 & 112
WE12X10011	LB276	120 to 124
WE12X33	DE401	102
WE12X42	LB216	120 to 124
WE12X43	LB217	120 to 124
WE12X46	LB218	120 to 124
WE12X47	DE401	102
WE12X49	LB217	120 to 124
WE12X5009	LB152	120 to 124
WE12X79	LB278	120 to 124
WE12X80	DE412	102
WE12X81	DE401	102
WE12X82	LB216	120 to 124
WE12X82R	LB216	120 to 124
WE12X83	DE412	102
WE12X85	LB202	120 to 124
WE12X88	LB260	120 to 124
WE12X92	DE412	102
WE12X93	LB278	120 to 124
WE12X95	DE411	102 & 112
WE12X96	DE411	102 & 112
WE13M23	DE730	102
WE13X10011	DE724	96 & 102
WE13X68K	DE729	102
WE13X93	DE730	102
WE14X10012	25M01A-100	92 to 110
WE14X10046	25M01A-101	98 to 110
WE14X171	25M01A-101	98 to 110
WE14X207	25M01A-101	98 to 110
WE14X214	25M01A-101	98 to 110
WE14X215	25M01A-101	98 to 110

Reference No.	Supco No.	Page
WE14X229	25M01A-101	98 to 110
WE18X26	DE520	95 & 102
WE1M463	DE771	99
WE1M481	DE775	99
WE1X1201	DE773	99
WE1X759D	DE400	99
WE25X10001	DE724	96 & 102
WE25X139	L155	91, 97, 103, 104 & 117
WE25X161	SET137	97 & 104
WE25X167	SET163	97, 103 & 104
WE25X205	DE725	102
WE25X205K	DE725	102
WE25X60	DE731	102
WE3X37	DE726R	99
WE3X70	DE727	95
WE3X75	DE726R	99
WE3X79	DE686	99, 111 & 112
WE3X82	DE702	100 & 112
WE3X86	DE685	100 & 113
WE3X87	DE776	100
WE4M126	ES16806	83, 93, 95, 100, 101, 108 & 119
WE4M127	SET187	97
WE4M136	FL240	97 & 116
WE4M137	SET800	97
WE4M156	L125	94, 97, 103, 104 & 117
WE4M160	SET104	94, 97, 104 & 109
WE4M216	L13510W	94, 97 & 116
WE4M80	L290	97 & 117
WE4X133	SET163	97, 103 & 104
WE4X151	L225	91, 94, 97, 103, 104 & 117
WE4X197	ES16700	100
WE4X254	SHF140	97 & 115
WE4X255	L130	94, 97, 103, 104 & 117
WE4X256	L175	91, 97 & 117
WE4X257	L225	91, 94, 97, 103, 104 & 117
WE4X258	SLF170VA	97 & 114
WE4X261	L180-40	94, 97, 103, 104 & 117
WE4X275	SET164	97
WE4X291	SET189	97
WE4X292	SET117	97, 104 & 109
WE4X293	L270	97 & 117
WE4X295	LD145	91, 97 & 117
WE4X323	LD170	97, 103 & 117
WE4X324	SET192	97
WE4X325	SET101	97
WE4X339	SET129	91 & 97
WE4X340	L325	97 & 117
WE4X394	L325	97 & 117
WE4X395	SET188	97
WE4X396	SET153	91, 97 & 109
WE4X419	SET189	97
WE4X422	L165	97 & 115
WE4X429	LD140	91, 94, 103, 104 & 117
WE4X444	SDE350	92, 96, 100, 106 & 113
WE4X448	DE355	100
WE4X454	L145	94, 97 & 117
WE4X485	L145	94, 97 & 117
WE4X497	SET192	97
WE4X498	SET189	97
WE4X5040	L225	91, 94, 97, 103, 104 & 117
WE4X5091	SET105	91, 94, 97, 103 & 104
WE4X5098	L130	94, 97, 103, 104 & 117
WE4X5099	FL260	94, 97, & 116
WE4X510	L340	91, 97, 104 & 117
WE4X5135	SET121	91, 97, 103 & 104

Reference No.	Supco No.	Page	Reference No.	Supco No.	Page	Reference No.	Supco No.	Page	Reference No.	Supco No.	Page
WE4X5136	LD155	91, 94, 97, 103 & 117	WE4X843	SDE364	93, 96, 100, 106 & 113	WR24X149	SGE517	35, 38, 40 to 44	WR24X291	SGE421	36, 37, 40 to 44
WE4X5137	SET144	97 & 109	WE4X856	SET189	97	WR24X150	SGE517	35, 38, 40 to 44	WR24X293	SGE432	36, 38, 40 to 44
WE4X5176	FL260	94, 97, & 116	WE4X857	SET401	97 & 109	WR24X151	SGE517	35, 38, 40 to 44	WR24X294	SGE432	36, 38, 40 to 44
WE4X532	ES15253	100	WE55	SWE55	37, 40 to 44	WR24X152	SGE517	35, 38, 40 to 44	WR24X295	SGE295	37, 40 to 44
WE4X543	SET191	97	WE58	SWE58	37, 40 to 44	WR24X153	SGE517	35, 38, 40 to 44	WR24X296	SGE432	36, 38, 40 to 44
WE4X544	L130	94, 97, 103, 104 & 117	WF1CB	WF284	30	WR24X154	SGE517	35, 38, 40 to 44	WR24X297	SGE432	36, 38, 40 to 44
WE4X545	L340	91, 97, 104 & 117	WFB	WF284	30	WR24X155	SGE517	35, 38, 40 to 44	WR24X299	SGE421	36, 37, 40 to 44
WE4X546	SET188	97	WFCB	WF284	30	WR24X157	SGE517	35, 38, 40 to 44	WR24X300	SGE300	37, 40 to 44
WE4X547	L130	94, 97, 103, 104 & 117	WH12X494	LP211	80	WR24X159	SGE517	35, 38, 40 to 44	WR24X301	SGE301	37, 40 to 44
WE4X549	L145	94, 97 & 117	WH13X76	GVW151	78, 80, 81, 83, 87	WR24X160	SGE517	35, 38, 40 to 44	WR24X302	SGE302	37, 40 to 44
WE4X550	L135	91, 94, 97 & 117	WH13X81	GVW151	78, 80, 81, 83, 87	WR24X161	SGE517	35, 38, 40 to 44	WR24X303	SGE303	37, 40 to 44
WE4X551	L140	94 & 97	WH16X513	LA188	80	WR24X162	SGE517	35, 38, 40 to 44	WR24X304	SGE433	36, 38, 40 to 44
WE4X552	SET192	97	WH1X10031	LB120	120 to 124	WR24X163	SGE517	35, 38, 40 to 44	WR24X309	SGE309	37, 40 to 44
WE4X582	LD145	91, 97 & 117	WH1X1249	LB120	120 to 124	WR24X164	SGE517	35, 38, 40 to 44	WR24X310	SGE422	36, 38, 40 to 44
WE4X583	SET189	97	WH1X1944	LP301	79	WR24X166	SGE517	35, 38, 40 to 44	WR24X311	SGE311	37, 40 to 44
WE4X584	SET191	97	WH1X1986	LP701	79	WR24X167	SGE517	35, 38, 40 to 44	WR24X312	SGE312	37, 40 to 44
WE4X586	SET187	97	WH1X2026	LB120	120 to 124	WR24X168	SGE517	35, 38, 40 to 44	WR24X313	SGE127	37, 40 to 44
WE4X587	SET188	97	WH1X2026R	LB120	120 to 124	WR24X169	SGE517	35, 38, 40 to 44	WR24X314	SGE433	36, 38, 40 to 44
WE4X589	L145	94, 97 & 117	WH1X2089	LP216	79	WR24X170	SGE517	35, 38, 40 to 44	WR24X315	SGE110	37, 40 to 44
WE4X590	L135	91, 94, 97 & 117	WH1X2630	LB117	120 to 124	WR24X171	SGE517	35, 38, 40 to 44	WR24X318	SGE318	37, 40 to 44
WE4X591	L140	94 & 97	WH1X2721	LP217	79 & 99	WR24X172	SGE517	35, 38, 40 to 44	WR24X319	SGE319	37, 40 to 44
WE4X592	SET192	97	WH1X2727	LA189	79	WR24X173	SGE517	35, 38, 40 to 44	WR24X390	SGE390	37, 40 to 44
WE4X593	L300	97 & 117	WH1X2760	LP227	79	WR24X175	SGE517	35, 38, 40 to 44	WR24X410	SGE433	36, 38, 40 to 44
WE4X594	L140	94 & 97	WH1X484	LP933	79	WR24X176	SGE517	35, 38, 40 to 44	WR24X411	SGE432	36, 38, 40 to 44
WE4X595	L155	91, 97, 103, 104 & 117	WH23X10003	LP129	80	WR24X177	SGE517	35, 38, 40 to 44	WR24X412	SGE433	36, 38, 40 to 44
WE4X596	L130	94, 97, 103, 104 & 117	WH23X10013	LP129	80	WR24X178	SGE517	35, 38, 40 to 44	WR24X413	SGE287	37, 40 to 44
WE4X597	LD130	91, 94, 97, 103 & 104	WH23X2X42	LP112	80	WR24X179	SGE517	35, 38, 40 to 44	WR24X414	SGE127	37, 40 to 44
WE4X599	LD130	91, 94, 97, 103 & 104	WH2X10032	LP10032	79	WR24X181	SGE517	35, 38, 40 to 44	WR24X415	SGE432	36, 38, 40 to 44
WE4X600	L145	94, 97 & 117	WH41X35	GNBA	80, 87, & 90	WR24X182	SGE517	35, 38, 40 to 44	WR24X416	SGE432	36, 38, 40 to 44
WE4X601	L135	91, 94, 97 & 117	WH41X367	SSD6GE	80 & 89	WR24X191	SGE517	35, 38, 40 to 44	WR24X418	SGE432	36, 38, 40 to 44
WE4X607	L145	94, 97 & 117	WH43X102	LP948	80	WR24X192	SGE517	35, 38, 40 to 44	WR24X419	SGE432	36, 38, 40 to 44
WE4X608	L135	91, 94, 97 & 117	WH43X87	LP949	80	WR24X193	SGE517	35, 38, 40 to 44	WR24X420	SGE432	36, 38, 40 to 44
WE4X639	L205	94, 97, 103 & 117	WH7X113	LB157	120 to 124	WR24X194	SGE517	35, 38, 40 to 44	WR24X421	SGE421	36, 37, 40 to 44
WE4X670	L130	94, 97, 103, 104 & 117	WH7X86	LB117	120 to 124	WR24X200	SGE517	35, 38, 40 to 44	WR24X422	SGE422	36, 38, 40 to 44
WE4X690	L120	91, 97, 103, & 117	WH7X98	LB117	120 to 124	WR24X202	SGE517	35, 38, 40 to 44	WR24X427	SGE432	36, 38, 40 to 44
WE4X691	SET187	97	WH8X10018	LP510	79	WR24X203	SGE117	37, 40 to 44	WR24X428	SGE422	36, 38, 40 to 44
WE4X692	DE382AWR	93, 94, 95, 98, 105, 109	WH8X246	LP510	79	WR24X204	SGE517	35, 38, 40 to 44	WR24X429	SGE421	36, 37, 40 to 44
WE4X693	DE382BWR	93, 94, 95, 98, 105, 109	WH8X281	LP604	79	WR24X205	SGE517	35, 38, 40 to 44	WR24X430	SGE422	36, 38, 40 to 44
WE4X708	25M01A-101	98 to 110	WH8X291K	LP603	79	WR24X206	SGE517	35, 38, 40 to 44	WR24X431	SGE318	37, 40 to 44
WE4X709	25M01A-101	98 to 110	WH8X305	LP656	80	WR24X207	SGE517	35, 38, 40 to 44	WR24X432	SGE432	36, 38, 40 to 44
WE4X711	FL200	94, 97, 103, 104 & 116	WP16	SCS79	39 to 44	WR24X218	SGE422	36, 38, 40 to 44	WR24X433	SGE433	36, 38, 40 to 44
WE4X715	L145DC	94, 97 & 115	WP21	SCS105	39 to 44	WR24X219	SGE422	36, 38, 40 to 44	WR24X437	SGE437	38, 40 to 44
WE4X739	SDE358	95, 100, 101	WP566	SCS102	39 to 44	WR24X220	SGE517	35, 38, 40 to 44	WR24X439	SGE301	37, 40 to 44
WE4X750	SDE364	93, 96, 100, 106 & 113	WP577	SCS103	39 to 44	WR24X221	SGE117	37, 40 to 44	WR24X440	SGE303	37, 40 to 44
WE4X755	L135	91, 94, 97 & 117	WP590	SCS46	39 to 44	WR24X222	SGE517	35, 38, 40 to 44	WR24X446	SGE446	38, 40 to 44
WE4X757	FL260	94, 97, & 116	WP608	SCS115	39 to 44	WR24X228	SGE517	35, 38, 40 to 44	WR24X449	SGE449	38, 40 to 44
WE4X774	SFL222VA	94, 97 & 114	WP609	SCS75	39 to 44	WR24X229	SGE517	35, 38, 40 to 44	WR24X450	SGE450	38, 40 to 44
WE4X800	SET800	97	WP617	SCS79	39 to 44	WR24X230	SGE433	36, 38, 40 to 44	WR24X454	SGE432	36, 38, 40 to 44
WE4X811	SET187	97	WP622	SCS105	39 to 44	WR24X231	SGE433	36, 38, 40 to 44	WR24X464	SGE464	38, 40 to 44
WE4X812	SET193	97	WP634	SCS97	39 to 44	WR24X232	SGE517	35, 38, 40 to 44	WR24X473	SGE432	36, 38, 40 to 44
WE4X813	SET190	97	WP638	SCS116	39 to 44	WR24X244	SGE433	36, 38, 40 to 44	WR24X474	SGE432	36, 38, 40 to 44
WE4X814	LP210	85, 101, 110 & 119	WP99	SCS99	39 to 44	WR24X245	SGE433	36, 38, 40 to 44	WR24X481	SGE481	38, 40 to 44
WE4X815	LP985	85, 112 & 119	WR14X5027	SGE433	36, 38, 40 to 44	WR24X246	SGE108	37, 40 to 44	WR24X484	SGE484	38, 40 to 44
WE4X818	L130	94, 97, 103, 104 & 117	WR14X5036	SGE422	36, 38, 40 to 44	WR24X247	SGE433	36, 38, 40 to 44	WR24X485	SGE485	38, 40 to 44
WE4X819	L125	94, 97, 103, 104 & 117	WR14X5037	SGE422	36, 38, 40 to 44	WR24X248	SGE433	36, 38, 40 to 44	WR24X486	SGE486	38, 40 to 44
WE4X820	SET193	97	WR23X5030	SL60	55	WR24X249	SGE433	36, 38, 40 to 44	WR24X5001	SGE108	37, 40 to 44
WE4X824	L145	94, 97 & 117	WR24X10049	SGE485	38, 40 to 44	WR24X250	SGE112	37, 40 to 44	WR24X5002	SGE433	36, 38, 40 to 44
			WR24X10050	SGE484	38, 40 to 44	WR24X251	SGE111	37, 40 to 44	WR24X5006	SGE433	36, 38, 40 to 44
			WR24X118	SGE517	35, 38, 40 to 44	WR24X252	SGE433	36, 38, 40 to 44	WR24X5013	SGE107	38, 40 to 44
			WR24X121	SGE517	35, 38, 40 to 44	WR24X255	SGE112	37, 40 to 44	WR24X5024	SGE422	36, 38, 40 to 44
			WR24X122	SGE517	35, 38, 40 to 44	WR24X260	SGE517	35, 38, 40 to 44	WR24X5068	SGE422	36, 38, 40 to 44
			WR24X124	SGE517	35, 38, 40 to 44	WR24X261	SGE517	35, 38, 40 to 44	WR24X5109	SGE433	36, 38, 40 to 44
			WR24X125	SGE517	35, 38, 40 to 44	WR24X262	SGE312	37, 40 to 44	WR24X5112	SGE108	37, 40 to 44
			WR24X129	SGE517	35, 38, 40 to 44	WR24X263	SGE127	37, 40 to 44	WR24X5113	SGE433	36, 38, 40 to 44
			WR24X130	SGE517	35, 38, 40 to 44	WR24X265	SGE517	35, 38, 40 to 44	WR24X5114	SGE433	36, 38, 40 to 44
			WR24X132	SGE517	35, 38, 40 to 44	WR24X266	SGE517	35, 38, 40 to 44	WR24X5115	SGE110	37, 40 to 44
			WR24X134	SGE517	35, 38, 40 to 44	WR24X267	SGE117	37, 40 to 44	WR24X5116	SGE433	36, 38, 40 to 44
			WR24X135	SGE517	35, 38, 40 to 44	WR24X268	SGE517	35, 38, 40 to 44	WR24X5118	SGE422	36, 38, 40 to 44
			WR24X137	SGE517	35, 38, 40 to 44	WR24X269	SGE517	35, 38, 40 to 44	WR24X5119	SGE422	36, 38, 40 to 44
			WR24X138	SGE517	35, 38, 40 to 44	WR24X271	SGE126	37, 40 to 44	WR24X5123	SGE433	36, 38, 40 to 44
			WR24X139	SGE517	35, 38, 40 to 44	WR24X272	SGE125	37, 40 to 44	WR24X5124	SGE422	36, 38, 40 to 44
			WR24X142	SGE517	35, 38, 40 to 44	WR24X273	SGE112	37, 40 to 44	WR24X5133	SGE312	37, 40 to 44
			WR24X143	SGE517	35, 38, 40 to 44	WR24X274	SGE111	37, 40 to 44	WR24X5134	SGE127	37, 40 to 44
			WR24X144	SGE517	35, 38, 40 to 44	WR24X282	SGE517	35, 38, 40 to 44	WR24X5148	SGE422	36, 38, 40 to 44
			WR24X148	SGE517	35, 38, 40 to 44	WR24X283	SGE517	35, 38, 40 to 44	WR24X5149	SGE422	36, 38, 40 to 44
						WR24X284	SGE284	37, 40 to 44	WR24X517	SGE517	35, 38, 40 to 44
						WR24X286	SGE286	37, 40 to 44	WR24X518	SGE485	38, 40 to 44
						WR24X287	SGE287	37, 40 to 44	WR24X5206	SGE421	36, 37, 40 to 44
						WR24X288	SGE284	37, 40 to 44	WR24X5211	SGE433	36, 38, 40 to 44
						WR24X289	SGE421	36, 37, 40 to 44	WR24X5212	SGE433	36, 38, 40 to 44

Reference No.	Supco No.	Page
WR24X5230	SGE433	36, 38, 40 to 44
WR24X5231	SGE5231	38, 40 to 44
WR24X5232	SGE5232	38, 40 to 44
WR24X524	SGE524	38, 40 to 44
WR24X5256	SGE432	36, 38, 40 to 44
WR24X5258	SGE433	36, 38, 40 to 44
WR24X526	SGE433	36, 38, 40 to 44
WR24X527	SGE433	36, 38, 40 to 44
WR24X528	SGE528	38, 40 to 44
WR24X558	SGE558	38, 40 to 44
WR29X5144	RIM300	20 to 27
WR29X5162	GA31	25
WR2X7232	SP7232	61
WR2X7233	SP7233	61
WR2X8345	SP8345	61
WR2X9144	SP9144	61
WR30M149	RIM300	20 to 27
WR30M153	RIM300	20 to 27
WR30X112	RIM300	20 to 27
WR30X129	RIM300	20 to 27
WR30X134	RIM300	20 to 27
WR30X138	RIM300	20 to 27
WR30X141	RIM300	20 to 27
WR30X142	RIM300	20 to 27
WR30X147	RIM300	20 to 27
WR30X148	RIM300	20 to 27
WR30X159	RIM300	20 to 27
WR30X163	RIM300	20 to 27
WR30X169	RIM300	20 to 27
WR30X170	RIM300	20 to 27
WR30X175	RIM300	20 to 27
WR30X176	RIM300	20 to 27
WR30X186	RIM300	20 to 27
WR30X187	RIM300	20 to 27
WR30X199	RIM300	20 to 27
WR30X203	RIM300	20 to 27
WR30X209	RIM300	20 to 27
WR30X211	RIM300	20 to 27
WR30X213	RIM300	20 to 27
WR30X214	RIM300	20 to 27
WR30X234	RIM300	20 to 27
WR30X237	RIM300	20 to 27
WR30X238	RIM300	20 to 27
WR30X239	RIM300	20 to 27
WR30X241	RIM300	20 to 27
WR30X253	RIM300	20 to 27
WR30X253R	RIM300	20 to 27
WR30X254	RIM300	20 to 27
WR30X255	RIM300	20 to 27
WR30X259	RIM300	20 to 27
WR30X280	RIM300	20 to 27
WR30X282	RIM300	20 to 27
WR30X282R	RIM300	20 to 27
WR30X283	RIM300	20 to 27
WR30X284	RIM300	20 to 27
WR30X289	RIM300	20 to 27
WR30X290	RIM300	20 to 27
WR30X304	RIM300	20 to 27
WR30X304	RIM300	20 to 27
WR30X304R	RIM300	20 to 27
WR30X305	RIM300	20 to 27
WR30X306	RIM300	20 to 27
WR30X307	RIM300	20 to 27
WR30X310	RIM300	20 to 27
WR30X315	RIM300	20 to 27
WR30X316	RIM300	20 to 27
WR30X318	RIM300	20 to 27
WR30X320	RIM300	20 to 27
WR30X326	RIM300	20 to 27
WR30X327	RIM300	20 to 27
WR30X328	RIM300	20 to 27
WR30X329	RIM300	20 to 27
WR30X330	RIM300	20 to 27
WR32X10398	CS10398	61
WR32X1094	CS10398	61
WR32X1107	CS10398	61
WR32X1122	CS10398	61
WR49X207	SH271	50 & 54
WR49X211	SL50	55

Reference No.	Supco No.	Page
WR49X234	SH271	50 & 54
WR49X243	SH271	50 & 54
WR49X249	SH271	50 & 54
WR49X250	SH276	50 & 54
WR49X390	SH273	50 & 54
WR49X391	SH271	50 & 54
WR49X392	SH276	50 & 54
WR49X430	SL5430	56, 58 to 60
WR49X5082	SM305	9 & 11
WR49X5086	SH273	50 & 54
WR49X5088	SH276	50 & 54
WR49X5106	SH276	50 & 54
WR50X10	SL60	55
WR50X10010	SL10010	56, 58 to 60
WR50X101	SL60	55
WR50X102	SL55	55
WR50X103	SL55	55
WR50X105	SL45	55
WR50X107	SL60	55
WR50X109	SL45	55
WR50X11	SL60	55
WR50X110	SL60	55
WR50X111	SL60	55
WR50X112	SL50112	56, 58 to 60
WR50X115	SL60	55
WR50X117	SL55	55
WR50X119	SL50129	56, 58 to 60
WR50X12	SL50	55
WR50X122	SL50122	56, 58 to 60
WR50X124	SL50124	56, 58 to 60
WR50X125	SL60	55
WR50X127	SL50129	56, 58 to 60
WR50X128	SL50122	56, 58 to 60
WR50X129	SL50129	56, 58 to 60
WR50X13	SL50	55
WR50X134	SL50134	56, 58 to 60
WR50X14	SL50	55
WR50X15	SL50	55
WR50X16	SL45	55
WR50X17	SL60	55
WR50X18	SL50	55
WR50X19	SL5022	24
WR50X20	SL50	55
WR50X21	SL60	55
WR50X22	SL5022	24
WR50X23	SL60	55
WR50X24	SL50	55
WR50X25	SL45	55
WR50X26	SL60	55
WR50X27	SL60	55
WR50X28	SL55	55
WR50X30	SL55	55
WR50X31	SL55	55
WR50X32	SL55	55
WR50X34	SL50	55
WR50X35	SL55	55
WR50X36	SL60	55
WR50X37	SL55	55
WR50X4	SL50	55
WR50X45	SL45	55
WR50X5	SL60	55
WR50X50	SL50	55
WR50X5001	SL50	55
WR50X5002	GC175	1 - 3
WR50X5003	SL45	55
WR50X5007	SL45	55
WR50X5009	SL60	55
WR50X5013	SL60	55
WR50X5014	SL45	55
WR50X5015	SL55	55
WR50X5016	SL45	55
WR50X5018	SL45	55
WR50X5019	SL60	55
WR50X5020	SL45	55
WR50X5021	SL50	55
WR50X5022	SL55	55
WR50X5023	SL45	55
WR50X5024	SL45	55
WR50X5025	SL60	55
WR50X5026	SL60	55

Reference No.	Supco No.	Page
WR50X5027	SL60	55
WR50X5028	SL50	55
WR50X5029	SL45	55
WR50X5030	SL45	55
WR50X5031	SL45	55
WR50X5032	SL50	55
WR50X5033	SL5022	24
WR50X5034	SL55	55
WR50X5041	SL50	55
WR50X55	SL55	55
WR50X6	SL45	55
WR50X60	SL60	55
WR50X65	SL60	55
WR50X66	SL50	55
WR50X68	SL50	55
WR50X7	SL60	55
WR50X70	SL50	55
WR50X73	SL55	55
WR50X74	SL55	55
WR50X75	SL55	55
WR50X76	SL60	55
WR50X77	SL60	55
WR50X83	SL90	55
WR50X88	SL90	55
WR50X89	SL60	55
WR50X9	SL5022	24
WR50X90	SL55	55
WR50X91	SL60	55
WR50X92	SL55	55
WR50X93	SL60	55
WR51X10002	SH464	52 & 54
WR51X133	SH302	51 & 54
WR51X169	SH301	51 & 54
WR51X183	SH271	50 & 54
WR51X188	SH271	50 & 54
WR51X192	SH276	50 & 54
WR51X194	SH307	51 & 54
WR51X202	SH271	50 & 54
WR51X231	SH271	50 & 54
WR51X258	SH276	50 & 54
WR51X319	SH464	52 & 54
WR51X342	SH309	52 & 54
WR51X343	SH309	52 & 54
WR51X344	SH310	52 & 54
WR51X345	SH310	52 & 54
WR51X349	SH309	52 & 54
WR51X350	SH309	52 & 54
WR51X367	SH464	52 & 54
WR51X371	SH309	52 & 54
WR51X372	SH310	52 & 54
WR51X404	SH309	52 & 54
WR51X411	SH307	51 & 54
WR51X412	SH301	51 & 54
WR51X413	SH308	52 & 54
WR51X425	SH464	52 & 54
WR51X430	SH464	52 & 54
WR51X442	SH309	52 & 54
WR51X443	SH310	52 & 54
WR51X447	SH464	52 & 54
WR51X461	SH310	52 & 54
WR51X463	SH309	52 & 54
WR51X464	SH464	52 & 54
WR51X5018	SH273	50 & 54
WR51X5144	SH273	50 & 54
WR51X5145	SH273	50 & 54
WR51X5150	SH273	50 & 54
WR51X5167	SH276	50 & 54
WR51X5172	SH276	50 & 54
WR51X58	SH221	49
WR60X100	SM338	9 & 11
WR60X104	SM338	9 & 11
WR60X105	SM338	9 & 11
WR60X108	SM338	9 & 11
WR60X112	SM338	9 & 11
WR60X116	SM338	9 & 11
WR60X118	SM338	9 & 11
WR60X119	SM338	9 & 11
WR60X120	SM338	9 & 11
WR60X122	SM338	9 & 11
WR60X125	SM338	9 & 11

Reference No.	Supco No.	Page
WR60X126	SM338	9 & 11
WR60X127	SM338	9 & 11
WR60X129	SM338	9 & 11
WR60X130	SM338	9 & 11
WR60X131	SM338	9 & 11
WR60X132	SM338	9 & 11
WR60X160	SM338	9 & 11
WR60X162	SM338	9 & 11
WR60X163	SM338	9 & 11
WR60X168	SM338	9 & 11
WR60X171	SM338	9 & 11
WR60X172	SM344	9 & 11
WR60X181	SM391	9 & 11
WR60X182	SM344	9 & 11
WR60X189	SM344	9 & 11
WR60X190	SM344	9 & 11
WR60X191	SM391	9 & 11
WR60X197	SM391	9 & 11
WR60X203	SM391	9 & 11
WR60X5005	SM338	9 & 11
WR60X5011	SM305	9 & 11
WR60X5016	SM305	9 & 11
WR60X5020	SM305	9 & 11
WR60X5021	SM305	9 & 11
WR60X5035	SM305	9 & 11
WR60X5040	SM305	9 & 11
WR60X5047	SM305	9 & 11
WR60X5048	SM305	9 & 11
WR60X5049	SM305	9 & 11
WR60X5053	SM338	9 & 11
WR60X5054	SM305	9 & 11
WR60X5057	SM305	9 & 11
WR60X5064	SM305	9 & 11
WR60X5066	SM305	9 & 11
WR60X5073	SM305	9 & 11
WR60X5074	SM305	9 & 11
WR60X52	SM305	9 & 11
WR60X54	SM305	9 & 11
WR60X60	SM305	9 & 11
WR60X65	SM305	9 & 11
WR60X71	SM305	9 & 11
WR60X74	SM305	9 & 11
WR60X82	SM338	9 & 11
WR60X84	SM305	9 & 11
WR60X85	SM338	9 & 11
WR60X88	SM305	9 & 11
WR7X10011	IC102	32
WR7X190	IC102	32
WR7X194	IC100	32
WR7X195	IC102	32
WR7X214	IC100	32
WR7X240	IC102	32
WR7X259	IC102	32
WR7X5142	IC102	32
WR8X122	OL2	32
WR9X10003	SC956	8
WR9X10041	SC954	8
WR9X10049	SC952	8
WR9X10075	SC954	8
WR9X10101	SC954	8
WR9X10111	SC954	8
WR9X114	FB450	19
WR9X115	GC116	1 - 3
WR9X125	GC116	1 - 3
WR9X128	GC116	1 - 3
WR9X145	GC116	1 - 3
WR9X158	GC116	1 - 3
WR9X177	GC116	1 - 3
WR9X182	GC116	1 - 3
WR9X183	GC116	1 - 3
WR9X208	GC116	1 - 3
WR9X209	GC116	1 - 3
WR9X216	GC116	1 - 3
WR9X223	GC140	1 - 3
WR9X237	GC116	1 - 3
WR9X239	GC140	1 - 3
WR9X242	GC175	1 - 3
WR9X245	GC140	1 - 3
WR9X246	GC140	1 - 3
WR9X248	GC140	1 - 3

Reference No.	Supco No.	Page
WR9X252	GC140	1 - 3
WR9X255	GC175	1 - 3
WR9X257	GC140	1 - 3
WR9X259	GC116	1 - 3
WR9X279	GC140	1 - 3
WR9X286	GC140	1 - 3
WR9X296	GC116	1 - 3
WR9X299	GC140	1 - 3
WR9X330	G1401GEO	8
WR9X333	GC140	1 - 3
WR9X337	GC116	1 - 3
WR9X338	GC116	1 - 3
WR9X343	GC140	1 - 3
WR9X347	GC116	1 - 3
WR9X352	GC175	1 - 3
WR9X353	GC140	1 - 3
WR9X355	GC140	1 - 3
WR9X357	GC140	1 - 3
WR9X360	GC140	1 - 3
WR9X387	K1401GEO	8
WR9X388	SPM6823-3	6
WR9X396	SPJ1111AM	7
WR9X398	GC178	1 - 3
WR9X399	GC178	1 - 3
WR9X401	GC175	1 - 3
WR9X405	GC175	1 - 3
WR9X411	GC177	1 - 3
WR9X422	GC178	1 - 3
WR9X446	GC177	1 - 3
WR9X448	GC188	1 - 3
WR9X458	GC188	1 - 3
WR9X460	GC178	1 - 3
WR9X480	SC957	8
WR9X481	SC950	8
WR9X482	SC951	8
WR9X483	SC954	8
WR9X489	SC952	8
WR9X491	GC188	1 - 3
WR9X499	GC192	1 - 3
WR9X501	GC178	1 - 3
WR9X502	SC955	8
WR9X5054	GC175	1 - 3
WR9X5090	GC175	1 - 3
WR9X5092	GC175	1 - 3
WR9X5094	GC175	1 - 3
WR9X5101	GC175	1 - 3
WR9X5106	GC175	1 - 3
WR9X5107	GC175	1 - 3
WR9X5121	GC175	1 - 3
WR9X516	SC956	8
WR9X517	GC190	1 - 3
WR9X520	SC958	8
WR9X548	SC953	8
WR9X566	SC959	8
WRX-4	RCO410	31
WRX-8	RCO810	31
WSX-1	SPP8E	62
WSX-5	SPP5	62
WSX-6	SPP6	62
WX5X1325	TB123A	80

Supco No.	Page No.
417	165
13495	155
14265	155
90290	64
90291	64
90292	64
90293	64
90294	64
90295	64
90340	63
90341	63
90342	63
90370	64
90372	64
90374	64
90380	64
90382	64
90384	64
00210	160
00211	160
00212	160
00213	160
00230	160
00231	160
00232	160
00250	160
00251	160
00270	160
00271	160
00280	160
00290	160
00291	160
00310	160
00311	160
00312	160
00313	160
00314	160
00315	160
00330	160
00332	160
00333	160
00350	160
00351	160
00360	160
1051-100	35
1051-50	35
10C7	83, 93, 150
10C7DC	150
1160-100	35
1160-50	35
1161	77
15T7C	150
15T7DC	150
25M01A-100	92 - 110

Supco No.	Page No.
25M01A-100	92 - 110
25M01A-101	98 - 110
25T61/2	150
25T61/2DC	150
25T8DC	150
25T8N	150
30-220-OS	48
30-OS	48
31	48
31-220	48
3803FE	90
3803FF	90
3803MF	90
3804FE	90
3804FEPV	90
3804FF	90
3804MF	90
3805FE	90
3805FEPV	90
3805FF	90
3805MF	90
3806FE	90
3806FEPV	90
3806FF	90
3806MF	90
3808FE	90
3808FF	90
3810FE	90
3810FF	90
3812FE	90
3812FF	90
3815FE	90
3815FF	90
40A15	150
40T10	150
40T10IF	150
40T61/2	150
43004	68
43005	68
43054	69
43057	69
43058	69
43154	70
43309	68
43320	68
43355	70
43359	68
43503	70
43558	70
43658	69
5451-100	35
5451-50	35
6662-100	35
6662-50	35

Supco No.	Page No.
6S6	150
6S6DC	150
70	48
70-220	48
70CSA	48
70CSA220	48
75	48
75-220	48
7C7	150
9063	63
9064	63
9065	63
9066	63
9067	63
9068	63
9069	63
9070	63
9071	63
9900H	178
9900K	178
9901K	178
9904H	178
9904K	178
9906H	178
9906K	178
9915K	178
A1401ADO	8
ADTA	155
APR5	63
AT012	115
AT013	115
AT014	115
AT015	115
AT021	115
AT022	115
B1401FO	8
BJ10	166
BJ10PLUS	166
BP4000S	134
BPV12	46
BPV14	46
BPV21	46
BPV31	46
BPV31D	46
BPV34	46
BPV36	46
BPV38	46
BPV56	46
BPV58	46
BPV78	46
BTG-54VL	72
BTG-54VLW	72
BTG-DB2	72
BTG-DK	72

Supco No.	Page No.
BTG-DO	72
BTG-EK	72
BTG-EM	72
BTG-EO	72
BTG-K	72
BTG-KM	72
BTG-KWM	72
BTG-O	72
BTG-RB2	72
BTG-RK	72
BTG-RM	72
BTG-RO	72
BTG-RWM	72
BTG-UB2	72
BTG-UK2	72
BTG-UM	72
BTG-UO2	72
BTG-UWM	72
C15	28
C15D	28
C15F	28
C15FD	28
C25	28
C25D	28
C25F	28
C25FD	28
CD15+10X370	65
CD15+5X370	65
CD20+15X370	65
CD20+5X370	65
CD20+5X370R	65
CD20+5X440R	65
CD20+7.5X370R	65
CD25+10X370	65
CD25+3X370	65
CD25+3X370R	65
CD25+4X370R	65
CD25+5X370	65
CD25+5X370R	65
CD25+5X440	65
CD25+5X440R	65
CD25+7.5X440R	65
CD30+3X370	65
CD30+3X370R	65
CD30+5X370	65
CD30+5X370R	65
CD30+5X440	65
CD30+5X440R	65
CD30+7.5X370	65
CD30+7.5X440R	65
CD35+10X440R	65
CD35+5X370	65
CD35+5X370R	65
CD35+5X440	65

Supco No.	Page No.
CD35+5X440R	65
CD35+7.5X370	65
CD35+7.5X440	65
CD35+7.5X440R	65
CD40+10X440R	65
CD40+5X370	65
CD40+5X370R	65
CD40+5X440	65
CD40+5X440R	65
CD40+7.5X440	65
CD40+7.5X440R	65
CD45+5X370	65
CD45+5X370R	65
CD45+5X440	65
CD45+5X440R	65
CD45+7.5X440	65
CD45+7.5X440R	65
CD50+5X440R	65
CD50+7.5X440R	65
CD55+10X440	65
CD55+10X440R	65
CD55+5X440R	65
CD55+7.5X370	65
CD55+7.5X440R	65
CD60+10X370	65
CD60+5X440R	65
CD60+7.5X440R	65
CD80+5X370R	65
CD80+7.5X370R	65
CPH100	157
CPO70	157
CR10X370	65
CR10X440	65
CR10X440R	65
CR12.5X370	65
CR12.5X440	65
CR15X370	65
CR15X370R	65
CR15X440	65
CR15X440R	65
CR17.5X370	65
CR17.5X440	65
CR20X370	65
CR20X370R	65
CR20X440	65
CR20X440R	65
CR25X370	65
CR25X370R	65
CR25X440	65
CR25X440R	65
CR2X370	65
CR2X440	65
CR30X370	65
CR30X370R	65

Supco No.	Page No.
CR30X440	65
CR30X440R	65
CR35X370	65
CR35X370R	65
CR35X440	65
CR35X440R	65
CR3X370	65
CR3X440	65
CR40X370	65
CR40X370R	65
CR40X440	65
CR40X440R	65
CR45X370	65
CR45X370R	65
CR45X440	65
CR45X440R	65
CR4X370	65
CR4X440	65
CR50X370	65
CR50X370R	65
CR50X440	65
CR50X440R	65
CR55X370R	65
CR55X440	65
CR55X440R	65
CR5X370	65
CR5X440	65
CR60X370	65
CR60X370R	65
CR60X440	65
CR60X440R	65
CR6X370	65
CR6X440	65
CR7.5X370	65
CR7.5X440	65
CR70X370	65
CR70X370R	65
CR70X440R	65
CR80X370R	65
CR80X440R	65
CS1000-1200X110	66
CS10398	61
CS108-130X110	66
CS108-130X220	66
CS108-130X330	66
CS124-156X110	66
CS124-156X165	66
CS124-156X220	66
CS124-156X330	66
CS130-156X330	66
CS145-175X110	66
CS145-175X165	66
CS145-175X220	66
CS145-175X330	66

Supco No.	Page No.
CS161-193X110	66
CS161-193X165	66
CS161-193X220	66
CS161-193X330	66
CS189-227X110	66, 87
CS189-227X220	66
CS189-227X330	66
CS200-240X110	66
CS21-25X110	66
CS21-25X220	66
CS21-25X330	66
CS216-227X220	66
CS216-259X110	66
CS216-259X220	66
CS216-259X330	66
CS233-292X110	66
CS233-292X165	66
CS233-292X220	66
CS25-30X110	66
CS25-30X220	66
CS25-30X330	66
CS270-324X110	66
CS270-324X165	66
CS270-324X220	66
CS270-324X330	66
CS300-360X110	66
CS30-36X110	66
CS30-36X220	66
CS30-36X330	66
CS324-388X110	66
CS324-388X330	66
CS340-408X110	66
CS36-43X110	66
CS36-43X220	66
CS36-43X330	66
CS378-440X110	66
CS400-480X110	66
CS43-56X110	66
CS43-56X220	66
CS43-56X330	66
CS460-552X110	66
CS53-70X330	66
CS540-648X110	66
CS56-72X110	66
CS56-72X220	66
CS56-72X330	66
CS590-708X110	66
CS64-77X110	66
CS64-77X220	66
CS708-850X110	66
CS72-88X110	66
CS72-88X220	66
CS72-88X330	66
CS829-995X110	66

Supco No.	Page No.
CS88-108X110	66
CS88-108X220	66
CS88-108X330	66
CT1	165
CTP1	164
CUFA	77, 89
CUFE	77, 89
D1401AMO	8
DDT2	152 , 153
DE138	106
DE148	108
DE180	110
DE195	110
DE247	107
DE315	101
DE315D	101
DE316	101
DE316D	101
DE326	106
DE327	107
DE333	101
DE334	101
DE335	95
DE336	95
DE337	101
DE338	95 & 101
DE339	95
DE343	108
DE353	93, 96, 101, 106
	111
DE355	100
DE381	93, 95, 110
DE382AWR	93, 94, 95, 98,
	105, 109
DE382BWR	93, 94, 95, 98,
	105, 109
DE382WR	94, 96, 98, 105
	109
DE400	99
DE401	102
DE405	106
DE407	93
DE410	99
DE411	102, 112
DE412	102
DE413	95
DE414	95
DE418	110, 112
DE520	95, 102
DE522	111
DE524	113
DE525	112
DE526	113
DE529	108

Supco No.	Page No.
DE530	107
DE531	107
DE532	108
DE533	108
DE534	108
DE601	112
DE602	106
DE685	100, 113
DE686	99, 111, 112
DE687	106
DE689	107
DE690	107
DE691	93
DE692	108
DE693	108
DE694	96
DE695	96
DE696	108
DE698	113
DE699	96
DE700	107
DE702	100, 112
DE702HD	113
DE702K	113
DE702T	112
DE724	96 , 102
DE725	102
DE726	99
DE726R	99
DE727	95
DE729	102
DE730	102
DE731	102
DE735	110
DE737	110
DE739	106
DE747	106
DE7477	113
DE766	95
DE768	110
DE771	99
DE773	99
DE775	99
DE776	100
DE777	107
DE780	107
DE782	107
DE783	92
DE784	96
DE785	108
DE786	108
DE787	96
DE788	78
DE790	96, 100

Supco No.	Page No.
DE791	92
DE793	92
DE794	92
DE795	92
DE796	93
DE838	102 & 111
DE901	110
DE902	93, 96, 99, & 106
DE902M	96, 99, 107 & 110
DE904	111
DE905	99 & 112
DE910	92
DE947	93
DG1012	144
DG1214	144
DG1416	144
DG1618	144
DG1820	144
DG2022	144
DG2224	144
DG2427	144
DG2731	144
DG40	144
DG41	144
DG42	144
DG43	144
DG44	144
DG5103	144
DG72	144
DG910	144
DGL1012	144
DGL1214	144
DGL1416	144
DGL1618	144
DGL1820	144
DGL2022	144
DGL2224	144
DGL2427	144
DHS55	164
DM10T	157
DP101	130 to 134
DP102	130 to 134
DP103	130 to 134
DP104	130 to 134
DP105	130 to 134
DP106	130 to 134
DP107	130 to 134
DP110	130 to 134
DP111	130 to 134
DP112	130 to 134
DP113	130 to 134
DP114	130 to 134
DP115	130 to 134

Supco No.	Page No.
DP116	130 to 134
DP117	130 to 134
DP122	130 to 134
DP125	130 to 134
DP125W	130 to 134
DP131	130 to 134
DP132	130 to 134
DP133	130 to 134
DP134	130 to 134
DP142	130 to 134
DP143	130 to 134
DP144	130 to 134
DP145	130 to 134
DP146	130 to 134
DP147	130 to 134
DP158	130 to 134
DP159	130 to 134
DP160	130 to 134
DP161	130 to 134
DP164	130 to 134
DP165	130 to 134
DP166	130 to 134
DP167	130 to 134
DP201	130 to 134
DP202	130 to 134
DP203	130 to 134
DP204	130 to 134
DP205	130 to 134
DP206	130 to 134
DP207	130 to 134
DP210	130 to 134
DP211	130 to 134
DP212	130 to 134
DP213	130 to 134
DP214	130 to 134
DP215	130 to 134
DP216	130 to 134
DP217	130 to 134
DP222	130 to 134
DP225	130 to 134
DP231	130 to 134
DP232	130 to 134
DP233	130 to 134
DP234	130 to 134
DP242	130 to 134
DP243	130 to 134
DP244	130 to 134
DP245	130 to 134
DP246	130 to 134
DP247	130 to 134
DP258	130 to 134
DP259	130 to 134
DP260	130 to 134
DP261	130 to 134

Supco No.	Page No.
DP264	130 to 134
DP265	130 to 134
DP266	130 to 134
DP267	130 to 134
DP333	130 to 134
DP334	130 to 134
DP364	130 to 134
DP365	130 to 134
DP433	130 to 134
DP434	130 to 134
DP464	130 to 134
DP465	130 to 134
DR001	61
DT12	152 & 153
DT22	152 & 153
DW10013	75
DW105	74 & 75
DW111	75
DW112	75
DW113	75
DW114	73
DW116	73
DW117	73
DW118	73
DW132	76
DW144	74
DW145	73
DW146	73
DW148	73
DW150	73
DW151	74
DW152	75
DW154	74
DW155	74
DW156	74
DW157	74
DW303	76
DW304	76
DW307	76
DW308	76
DW309	74
DW439	76
DW440	74
DW601	73
DW602	73
DW605	76
DW606	76
DW610	76
DW804	77
DWLC	77
EDT10	5
EDT11	5
EDT20	5
EDT21	5

Supco No.	Page No.
EL323	161
ELB101	162
ELB201	162
ELB250	161
ELB251	161
ELB301	161
ELB302	161
ELB303	161
ELB304	161
ELB305	161
ELB312	161
ELB320	161
ELB321	161
ELB322	161
ELB340	162
ELB345	162
ELB346	162
ELB400	163
ELB401	163
ELB401/R	163
ELB402	163
ELB402/R	163
ELB701-L	163
ELB710/R	163
ELB711/R	163
ELB713	163
ELB714	161
ELB717	160
ELB720	163
ELB721	163
ELB726	162
ELB730	161
ELB801	160
ELB802	160
ELB810	160
ELB811	160
ELB904	160
ELB910	160
ELB913	160
ES15100	141
ES15102	141
ES15105	141
ES15106	141
ES15108	141
ES15200	141
ES15201	141
ES15202	141
ES15204	141
ES15205	141
ES15211	141
ES15253	100
ES15400	141
ES15401	141
ES15402	141

Supco No.	Page No.
ES15501	141
ES15502	118
ES15601	118
ES15801	118
ES15803	118
ES15805	118
ES15806	118
ES15807	93, 118
ES15810	118
ES15811	118
ES15813	118
ES15901	118
ES15902	118
ES15903	118
ES15905	118
ES15907	93, 112, 118
ES16100	76, 81, 111, 112 118
ES16200	78, 92, 106, 118
ES16300	73, 76, 82, 118
ES16301	82, 92, & 118
ES16400	85, 110 & 118
ES16600	76, 81, 107, 119
ES16700	100
ES16802	24, 73, 119
ES16806	83, 93, 95, 100, 101, 108, 119
ES16807	78, 83, 119
ES16814	119
ES18100	45
ES18200	45
ES18300	45
ES18500	45
ES18600	45
ES18700	45
ES18801	45
ES18802	45
ES18803	45
ES18804	45
ES18805	45
ES18806	45
ES18807	45
ES18809	45
ES18810	45
ES18811	45
ES18812	45
ES18813	45
ES18814	45
ES18815	45
ES18816	45
ES18817	45
ES247	88 , 119
ES5500200	146 - 148
ES5500202	146 - 148

Supco No.	Page No.
ES5500200	146 - 148
ES5500202	146 - 148
ES5500203	146 - 148
ES5500204	146 - 148
ES5500206	146 - 148
ES5500207	146 - 148
ES5500225	146 - 148
ES5500299	146 - 148
ES671	85, 119
ES682	83, 119
ES7166	82 - 83
ES8084	88, 119
F336	72
FB101	19
FB102	19
FB103	19
FB104	19
FB105	19
FB106	19
FB107	19
FB108	19
FB109	19
FB150	19
FB151	19
FB152	19
FB153	19
FB156	19
FB157	19
FB158	19
FB159	19
FB162	19
FB163	19
FB164	19
FB165	19
FB166	19
FB167	19
FB170	19
FB171	19
FB172	19
FB173	19
FB174	19
FB175	19
FB178	19
FB179	19
FB180	19
FB181	19
FB182	19
FB183	19
FB186	19
FB187	19
FB188	19
FB189	19
FB190	19
FB191	19

Supco No.	Page No.
FB250	18
FB299	18
FB300	18
FB301	18
FB302	18
FB325	18
FB350	18
FB351	19
FB352	19
FB353	19
FB401	18
FB402	18
FB403	18
FB404	18
FB406	18
FB450	19
FB455	12, 19
FB456	19
FB457	19
FB460	18
FB461	18
FB501	18
FB502	18
FB503	18
FB504	18
FB505	18
FB506	18
FB550	18
FB551	18
FB590	18
FB601	18
FB602	18
FB603	18
FB604	18
FB605	18
FB606	18
FB650	18
FB651	18
FB652	18
FB660	18
FB665	18
FB701	18
FB702	18
FB703	18
FB704	18
FB718	18
FB718G	18
FB801	18
FB802	18
FB803	18
FB804	18
FBP100	165
FC0810	164
FC0915	164

Supco No.	Page No.
FC1113	164
FC1214	164
FC1617	164
FC1820	164
FC2224	164
FCR6	164
FL135	116
FL15020	103, 116
FL15040	116
FL155	116
FL190	116
FL200	94, 97, 103, 104
	116
FL205	116
FL220	116
FL225	91, 103, 116
FL240	97, 116
FL250	116
FL260	94, 97, 116
FL285	94, 116
FL320	94, 103, 116
FL350	103, 116
FL50	115
FL60	115
FLAT012	115
FLAT013	115
FLAT014	115
FLAT015	115
FLAT021	115
FLAT022	115
FLD135	91, 103, 116
FLD205	116
FPT10	164
FPT13	164
FPT15	164
FWB1	165
G1401GEO	8
GA25	150
GA26	150
GA27	150
GA31	25
GA700	25
GC116	1 - 3
GC140	1 - 3
GC161	1 - 3
GC175	1 - 3
GC177	1 - 3
GC178	1 - 3
GC182	1 - 3
GC183	1 - 3
GC185	1 - 3
GC188	1 - 3
GC190	1 - 3
GC192	1 - 3

Supco No.	Page No.
GC193	1 - 3
GC195	1 - 3
GC401	4
GC405	4
GC411	4
GC501	4
GC503	4
GC505	4
GC506	4
GC601	4
GC602	4
GC604	4
GC607	4
GC701	5
GC702	5
GC707	5
GNB	89
GNBA	80, 87
GNBA	80, 87, & 90
GVW151	78, 80, 81, 83, 87
HF757	114
HK7	166
HL103	90
HL758	114
HM101	90
HP421	87
HS10001	173
HS10004	173
HS10016	173
HS10128	173
HS11001	173
HS11004	173
HS11016	173
HS11128	173
HS12001	173
HS16001	175
HS17001	173
HS17004	173
HS17016	173
HS18004	175
HS20004	174
HS20016	174
HS20128	174
HS21004	174
HS21016	174
HS21128	174
HS22008	174
HS22032	174
HS22128	174
HS23008	174
HS23032	174
HS23128	174
HS24001	175

Supco No.	Page No.
HS24010	175
HS24128	175
HS26004	174
HS26016	174
HS26128	174
HS30004	173
HS30016	173
HS40008	177
HS40128	177
HS41008	177
HS41128	177
HS50004	177
HS51032	175
HS51128	175
HS52032	177
HS52105	177
HS52115	177
HS52128	177
HS55032	175
HS55128	175
HS56011	176
HS57014	176
HS58128	176
HS58520	176
HS59128	176
HS59520	177
HSINJ001	174
HSUVB001	173
HVT2	164
HYP38	90
IC100	32
IC102	32
ICG1	31
ICG-220	31
IM1	165
IM2	165
IM3	165
IM4	165
IM5	165
IMK3	165
IMM6306	25
IMM8366	20 to 27
IST2	28
JS1	166
K1401GEO	8
KA12	178
KA36	178
L120	91, 97, 103, 117
L125	94, 97, 103, 104 117
L130	94, 97, 103, 104 117
L135	91, 94, 97 & 117
L13510W	94, 97 & 116

Supco No.	Page No.
L13515W	94, 97, 116
L135DC	94, 115
L140	94, 97
L145	94, 97, 117
L14515W	94, 97, 116
L14520W	91, 104, 109 116
L145DC	94, 97, 115
L14625W	116
L150	91, 94, 103, 104 117
L15015W	116
L15025W	116
L155	91, 97, 103, 104 117
L15510W	91, 103, 104, 109
L15515W	116
L15525W	91, 109 & 116
L160	117
L165	97 & 115
L170	91 & 117
L175	91, 97 & 117
L180-20	97 & 117
L180-40	94, 97, 103, 104 117
L190	94 & 117
L200	91, 94, 103, 104 117
L205	94, 97, 103 & 117
L21030W	116
L210DC	115
L225	91, 94, 97, 103, 104, 117
L240	117
L250	94, 104, 117
L255	103, 104, 117
L260	117
L270	97, 117
L290	97, 117
L300	97, 117
L320	117
L325	97, 117
L340	91, 97, 104, 117
LA091	89
LA092	89
LA094	89
LA095	89
LA096	89
LA100	89
LA188	80
LA189	79
LB110	120 - 124

Supco No.	Page No.
LB111	120 - 124
LB113	120 - 124
LB117	120 - 124
LB120	120 - 124
LB125	120 - 124
LB126	120 - 124
LB127	120 - 124
LB131	120 - 124
LB132	120 - 124
LB137	120 - 124
LB140	120 - 124
LB142	120 - 124
LB143	120 - 124
LB150	120 - 124
LB151	120 - 124
LB152	120 - 124
LB154	120 - 124
LB155	120 - 124
LB157	120 - 124
LB160	120 - 124
LB161	120 - 124
LB175	120 - 124
LB201	120 - 124
LB202	120 - 124
LB204	120 - 124
LB210	120 - 124
LB212	120 - 124
LB216	120 - 124
LB217	120 - 124
LB218	120 - 124
LB230	120 - 124
LB231	120 - 124
LB232	120 - 124
LB233	120 - 124
LB234	120 - 124
LB235	120 - 124
LB236	120 - 124
LB237	120 - 124
LB240	120 - 124
LB244	120 - 124
LB251	120 - 124
LB254	120 - 124
LB260	120 - 124
LB270	120 - 124
LB271	120 - 124
LB274	120 - 124
LB275	120 - 124
LB276	120 - 124
LB278	120 - 124
LB279	120 - 124
LB280	120 - 124
LB284	120 - 124
LB287	120 - 124
LB288	120 - 124

Supco No.	Page No.
LB111	120 - 124
LB113	120 - 124
LB117	120 - 124
LB120	120 - 124
LB125	120 - 124
LB126	120 - 124
LB127	120 - 124
LB131	120 - 124
LB132	120 - 124
LB137	120 - 124
LB140	120 - 124
LB142	120 - 124
LB143	120 - 124
LB150	120 - 124
LB151	120 - 124
LB152	120 - 124
LB154	120 - 124
LB155	120 - 124
LB157	120 - 124
LB160	120 - 124
LB161	120 - 124
LB175	120 - 124
LB201	120 - 124
LB202	120 - 124
LB204	120 - 124
LB210	120 - 124
LB212	120 - 124
LB216	120 - 124
LB217	120 - 124
LB218	120 - 124
LB230	120 - 124
LB231	120 - 124
LB232	120 - 124
LB233	120 - 124
LB234	120 - 124
LB235	120 - 124
LB236	120 - 124
LB237	120 - 124
LB240	120 - 124
LB244	120 - 124
LB251	120 - 124
LB254	120 - 124
LB260	120 - 124
LB270	120 - 124
LB271	120 - 124
LB274	120 - 124
LB275	120 - 124
LB276	120 - 124
LB278	120 - 124
LB279	120 - 124
LB280	120 - 124
LB284	120 - 124
LB287	120 - 124
LB288	120 - 124

Supco No.	Page No.
LB291	120 - 124
LB292	120 - 124
LB293	120 - 124
LB294	120 - 124
LB295	120 - 124
LB297	120 - 124
LB298	120 - 124
LB299	120 - 124
LB300	120 - 124
LB301	120 - 124
LB302	120 - 124
LB306	120 - 124
LD120	91, 94, 103, 117
LD130	91, 94, 97, 103 104
LD135	91, 94, 97, 103 117
LD140	91, 94, 103, 104 117
LD145	91, 97, 117
LD14520W	104, 117
LD15025W	117
LD155	91, 94, 97, 103 117
LD15510W	117
LD15525W	104 & 117
LD170	97, 103, 117
LD190	117
LD200	94, 117
LD210	94, 117
LD225	94, 117
LD240	94, 117
LD270	117
LD290	117
LD305	94, 117
LIT11C	151
LIT50	151
LIT6	151
LIT8B	151
LP10032	79
LP112	80
LP113	86
LP114	86
LP115	85
LP116	88
LP117	81
LP118	78
LP121	88
LP123	83
LP127	78, 83
LP128	83
LP129	80
LP1586	78, 83, 85, & 90
LP173	85, 110 & 119

Supco No.	Page No.
LP210	85, 101, 110 & 119
LP211	80
LP216	79
LP217	79, 99
LP218	86, 112
LP219	86
LP220	87
LP225	88
LP226	88
LP227	79
LP228	88
LP234	88
LP246	84
LP247	84
LP2533	83
LP254	86
LP285	86
LP301	79
LP318	87
LP319	86
LP331	84
LP332	85
LP337	86
LP337HD	86
LP338	84
LP338D	84
LP340	81
LP341	81
LP347	81
LP348	81
LP349	81
LP394	78
LP510	79
LP515	78
LP580	82
LP581	82
LP5834	86, 90
LP585	82
LP598	84
LP602	79
LP603	79
LP604	79
LP617	84
LP630	86
LP631	84
LP632	84
LP633	87
LP634	87
LP655	84
LP656	80
LP663	81
LP665	82
LP666	82

Supco No.	Page No.
LP668	82
LP670	77
OR100	144
OR101	144
OR102	144
OV32	33
OV34	33, 34
OV36	33, 34
OV38	33, 34
OV40	33, 34
OV42	33, 34
OV44	33, 34
OV46	33, 34
OV48	33, 34
OV50	33
P85	164
P89	164
PIT1	152, 153
PO115	31
PO230	31
PON2A	31
PRO22	31
PRO41	31
PRO42	31
PRO62	31
PRO81	31
PRO82	31
PT100	152, 153
PT100C	152, 153
PT100H	152, 153
PT100HC	152, 153
PT25	28
PT25E	28, 67
Q101	67
Q102	67
Q103	67
Q104	67
Q105	67
Q106	67
Q107	67
Q108	67
Q109	67
Q110	67
Q111	67
Q112	67
Q113	67
RC1216	163
RC1220	163
RC2104	162
RC2106	162
RC2108	162
RC2110	162
RC2112	162
RC3110	162

Supco No.	Page No.
RC3114	162
RC4300	161
RC5000	161
RC5003	161
RC5010	161
RC5019	161
RCO210	31
RCO220	31
RCO410	31
RCO420	31
RCO620	31
RCO810	31
RCO820	31
RIM115	20 - 27
RIM116	20 - 27
RIM117	20 - 27
RIM2000	20 - 27
RIM300	20 - 27
RIM313	20 - 27
RIM316	20 - 27
RIM400	20 - 27
RIM500	20 - 27
RIM900	20 - 27
RIM943	20 - 27
RK100	149
RK101	149
RK102	149
RK103	149
RK190	149
RK200	149
RK201	149
RK202	149
RK203	149
RK301	149
RK362	149
RK401	149
RK458	149
RK699	149
RK701	149
RO22	31
RO41	31
RO42	31
RO62	31
RO81	31
RO82	31
RP0512G	142
RP0512GB	142
RP0512NG	143
RP0514G	142
RP0514GB	142
RP0514NG	143
RP21225GB	142
RP21250GB	142
RP21425GB	142

Supco No.	Page No.
RP21450GB	142
RP2512G	142
RP2512GB	142
RP2512NG	143
RP2514G	142
RP2514GB	142
RP2514NG	143
RP2516H	143
RP44K5012	135
RP44X126	135
RP44X127	135
RP44X134	135
RP44X164	135
RP44X173	135
RP44X200	135
RP44X228	135
RP44X5043	135
RP44X5074	135
RP44X5082	135
RP44X5083	135
RP44X5099	136
RP45X56	136
RP4835	136
RP4876	136
RP5012G	142
RP5012GB	142
RP5014G	142
RP5014GB	142
RP528	136
RP571	136
RP572	136
RP579	136
RP580	136
RP583	136
RP584	136
RP5862	136
RP587	136
RP591	136
RP595	136
RP613	136
RP619	137
RP620	137
RP624	137
RP629	137
RP632	137
RP640	137
RP641	137
RP651	137
RP653	137
RP660	137
RP672	137
RP673	137
RP680	137
RP6800	137

Supco No.	Page No.
RP681	137
RP700	138
RP701	138
RP7019	138
RP7155	138
RP716	138
RP717	138
RP720	138
RP738	138
RP743	138
RP746	138
RP748	138
RP751	138
RP761	138
RP775	138
RP776	138
RP777	138
RP778	139
RP779	139
RP780	139
RP781	139
RP789	139
RP790	139
RP792	139
RP793	139
RP798	139
RP799	139
RP805	139
RP815	139
RP825	139
RP829	139
RP832	139
RP835	139
RP836	140
RP837	140
RP839	140
RP840	140
RP841	140
RP853	140
RP856	140
RP858	140
RP862	140
RP871	140
RP872	140
RP958	140
RP969	140
RP978	140
RP979	140
RP980	140
RP985	141
RP987	141
RR105	129
RR109	129
RR110	129

Supco No.	Page No.
RR117	129
RR122	129
RR382	129
RS101	144
RSC10	31
RSC20	31
RW516	165
RW916	165
RWA10	165
S8	172
SA1	47
SA1005	9, 22, 26, 27
SA2	47
SAB233	159
SAB243	159
SAB243R	159
SAB444	159
SAB454	159
SAB454R	159
SAB505	159
SAB505R	159
SAB510	159
SAB515	159
SAB601	159
SAB688	162
SAB705	159
SAB705R	159
SAB710	159
SAD100	38
SAD101	38
SAD38	38
SAD67	38
SAD68	38
SAD69	38
SAD70	38
SAD71	38
SAD72	39 - 44
SAD73	39 - 44
SAD76	38
SAD77	38
SAD81	39 - 44
SAD82	38
SAD97	38
SAD99	38
SAM29	39 - 44
SAM32	39 - 44
SAM33	39 - 44
SAM34	39 - 44
SAM35	39 - 44
SAM39	39 - 44
SAM40	39 - 44
SAM41	39 - 44
SAM43	39 - 44
SAM44	39 - 44

Supco No.	Page No.
SAM54	38, 40, 44
SAM55	38, 40, 44
SAM56	38, 40, 44
SAM57	38, 40, 44
SAM58	38, 40, 44
SAM59	38, 40, 44
SAM63	38, 40, 44
SAR21	166
SB001	18
SC1000	5
SC1002	5
SC801	7
SC802	7
SC803	7
SC804	7
SC806	7
SC807	7
SC808	7
SC950	8
SC951	8
SC952	8
SC953	8
SC954	8
SC955	8
SC956	8
SC957	8
SC958	8
SC959	8
SC960	8
SCCP	157, 158
SCDM	157, 158
SCS102	157, 158
SCS103	157, 158
SCS105	157, 158
SCS107	39 - 44
SCS108	39 - 44
SCS112	39 - 44
SCS115	39 - 44
SCS116	39 - 44
SCS27	39 - 44
SCS42	39 - 44
SCS44	39 - 44
SCS46	39 - 44
SCS71	39 - 44
SCS75	39 - 44
SCS79	39 - 44
SCS97	39 - 44
SCS98	39 - 44
SCS99	39 - 44
SD75125	77
SDE350	92, 96, 100, 106 113
SDE358	95, 100, 101
SDE359	92

Supco No.	Page No.
SDE364	93, 96, 100, 106 113
SET101	97
SET102	91 & 103
SET103	103, 104, 109
SET104	94, 97, 104, 109
SET105	91, 94, 97, 103, 104
SET106	103, 104
SET107	91
SET108	103, 104
SET109	91, 103, 104
SET110	91, 103, 104
SET111	103, 104
SET113	109
SET115	94, 104
SET117	97, 104, 109
SET118	109
SET119	94, 109
SET121	91, 97, 103, 104
SET122	109
SET123	109
SET129	91, 97
SET133	91, 103, 104
SET137	97, 104
SET140	104
SET144	97, 109
SET145	103, 104
SET149	109
SET153	91, 97, 109
SET163	97, 103, 104
SET164	97
SET174	104
SET175	103, 104, 109
SET176	104
SET177	109
SET182	91
SET183	91
SET184	109
SET185	109
SET187	97
SET188	97
SET189	97
SET190	97
SET191	97
SET192	97
SET193	97
SET194	109
SET195	103, 104, 109
SET196	104
SET197	109
SET198	109
SET200	91 & 109
SET201	109

Supco No.	Page No.
SET401	97, 109
SET402	109
SET403	104
SET404	104
SET405	104
SET407	105
SET408	105
SET409	105
SET410	109
SET800	97
SF1010	47
SF1808	46
SF2525	47
SF3500	165
SF3510	165
SF3515	165
SF3525	165
SF3535	165
SF3570	165
SF3600	47
SF3602	47
SF3603	47
SF3604	47
SF3605	47
SF3606	47
SF3608	47
SF3800	47
SF3813	47
SF3970	164
SF4040	46
SF4311	47, 164
SF4314	47, 164
SFPC	57
SFR100	37, 40, 44
SFR75	37, 40, 44
SFR85	37, 40, 44
SGE107	37, 40, 44
SGE108	37, 40, 44
SGE110	37, 40, 44
SGE111	37, 40, 44
SGE112	37, 40, 44
SGE117	37, 40, 44
SGE125	37, 40, 44
SGE126	37, 40, 44
SGE127	37, 40, 44
SGE284	37, 40, 44
SGE286	37, 40, 44
SGE287	37, 40, 44
SGE295	37, 40, 44
SGE300	37, 40, 44
SGE301	37, 40, 44
SGE302	37, 40, 44
SGE303	37, 40, 44
SGE309	37, 40 to 44

Supco No.	Page No.
SGE311	37, 40, 44
SGE312	37, 40, 44
SGE318	37, 40, 44
SGE319	37, 40, 44
SGE390	37, 40, 44
SGE421	36, 37, 40, 44
SGE422	36, 37, 40, 44
SGE432	36, 37, 40, 44
SGE433	36, 37, 40, 44
SGE437	36, 37, 40, 44
SGE446	36, 37, 40, 44
SGE449	36, 37, 40, 44
SGE450	36, 37, 40, 44
SGE454	36, 37, 40, 44
SGE464	36, 37, 40, 44
SGE481	36, 37, 40, 44
SGE484	36, 37, 40, 44
SGE485	36, 37, 40, 44
SGE486	36, 37, 40, 44
SGE5015	36, 37, 40, 44
SGE517	36, 37, 40, 44
SGE5231	38, 40, 44
SGE5232	38, 40, 44
SGE524	38, 40, 44
SGE528	38, 40, 44
SGE558	38, 40, 44
SGI46	37, 40, 44
SGI47	37, 40, 44
SGR400	145
SGR401	145
SGR402	145
SGR403	145
SGR404	145
SGR405	145
SGR407	145
SGR408	145
SGR409	145
SGR410	145
SGR411	145
SGR412	145
SGR413	145
SGR414	145
SGR415	145
SGV04	167
SGV05	167
SGV06	167
SGV07	167
SGV08	167
SGV10	167
SGV14	167
SGV16	167
SGVA1	167
SGVA2	167
SH201	48

Supco No.	Page No.
SH202	48
SH203	48
SH204	48
SH205	48
SH206	48
SH207	48
SH221	49
SH222	49
SH223	49
SH224	49
SH225	49
SH226	49
SH251	49
SH261	50, 54
SH263	50, 54
SH264	50, 54
SH265	50, 54
SH266	50, 54
SH267	50, 54
SH270	50, 54
SH271	50, 54
SH273	50, 54
SH274	50, 54
SH276	50, 54
SH277	50, 52, 54
SH278	51, 54
SH281	49
SH282	49
SH283	49
SH284	49
SH301	51, 54
SH302	51, 54
SH303	51, 54
SH305	51, 54
SH306	51, 54
SH307	51, 54
SH308	52, 54
SH309	52, 54
SH310	52, 54
SH311	52, 54
SH319	52, 54
SH320	52, 54
SH326	52, 54
SH327	52, 54
SH374	52, 54
SH413	53, 54
SH414	53, 54
SH415	51, 54
SH416	53, 54
SH419	51, 54
SH429	53, 54
SH431	53, 54
SH432	53, 54
SH433	53, 54

Supco No.	Page No.
SH434	53, 54
SH437	52, 54
SH439	51, 54
SH442	53, 54
SH443	53, 54
SH445	51, 54
SH447	53, 54
SH448	53, 54
SH457	51, 54
SH464	52, 54
SH500	49
SH502	49
SH503	49
SH504	49
SH505	49
SHF110	115
SHF110DC	115
SHF120	115
SHF130	104, 115
SHF140	97, 115
SHF150	115
SHF160	103, 115
SHF170	115
SHF180	115
SHF200	115
SHF250	115
SHF90	115
SHL120	115
SHL140	115
SHL150	115
SHL160	115
SHL170	115
SHL180	115
SHL190	115
SHL200	115
SHL210	115
SHL230	115
SHL250	115
SHL300	115
SHL325	115
SHS012	167
SHS03	167
SHS04	167
SHS06	167
SHS08	167
SHS16	167
SHSA1	167
SHSA2	167
SK3W2	62
SK3W3	62
SK3W4S	62
SK3W5	62
SK3W6S	62
SKL36	37, 40 - 44

Supco No.	Page No.
SL10010	56, 58 - 60
SL2205	56, 58 - 60
SL243	55
SL245	55
SL247	55
SL249	55
SL250	55
SL2690	56, 58 - 60
SL2691	56, 58 - 60
SL2697	57 - 60
SL3084	57 - 60
SL45	55
SL50	55
SL50112	56, 58 - 60
SL50122	56, 58 - 60
SL50124	56, 58 - 60
SL50129	56, 58 - 60
SL50134	56, 58 - 60
SL5022	24
SL5430	56, 58 - 60
SL55	55
SL5708	57 - 60
SL5709	57 - 60
SL5844	24
SL60	55
SL6155	57 - 60
SL6319	24
SL6322	24
SL6792	56, 58 - 60
SL70	55
SL7490	57 - 60
SL7500	57 - 60
SL7503	57 - 60
SL79002	57 - 60
SL79005	57 - 60
SL7985	24
SL80	55
SL8366	56, 58 - 60
SL8509	56, 58 - 60
SL8510	56, 58 - 60
SL8513	56, 58 - 60
SL8515	56, 58 - 60
SL8517	56, 58 - 60
SL8519	56, 58 - 60
SL8528	56, 58 - 60
SL90	55
SLF130VA	114
SLF155VA	91, 114
SLF158VB	114
SLF165VA	114
SLF170VA	97, 114
SLF185VB	114
SLF190HA	114
SLF194HB	114

Supco No.	Page No.
SLF194VB	114
SLF200HA	114
SLF200VA	114
SLF210HA	114
SLF222VA	94, 97, 114
SLF230HA	114
SLF230HB	114
SLF250HA	114
SLF252VB	114
SLF255VA	91, 103, 114
SLF260HA	114
SLF275HB	114
SLF275VB	114
SLF280HB	114
SLF300HB	114
SLF300VA	114
SLF330VA	94, 114
SLS120	114
SLS130	114
SLS140	114
SLS145	114
SLS150	114
SLS155	114
SLS160	114
SLS165	114
SLS170	114
SLS175	114
SLS180	114
SLS200	114
SLS250	114
SLS255	114
SLS265	114
SLS275	114
SLS285	114
SLS295	114
SLS300	114
SLS300HB	114
SLS350	114
SLS85	114
SLSW210	114
SLSW300	114
SLSW300HB	114
SLSW350	114
SLT45	55, 56
SLT50	55
SLT55	55
SLT60	55
SLT70	55
SLT80	55
SM140-40A	12
SM279787	111
SM305	9, 11
SM316	9, 11
SM319	9, 11

Supco No.	Page No.
SM327	10 - 11
SM328	10 - 11
SM329	10 - 11
SM332	9, 11
SM333	9, 11
SM334	9, 11
SM335	9, 11
SM3352287	88
SM336	9, 11
SM337	10 - 11
SM338	9, 11
SM339	10 - 11
SM342	10 - 11
SM343	10 - 11
SM344	9 & 11
SM345	10 - 11
SM346	10 - 11
SM362	10 - 11
SM365	10 - 11
SM378	9, 11
SM389248	87
SM391	9, 11
SM399	10 - 11
SM550	16
SM551	16
SM552	16
SM553	16
SM554	16
SM555	16
SM556	16
SM670	15
SM6700B	12
SM671	15
SM672	15
SM673	15
SM674	15
SM675	15
SM676	15
SM678	15
SM679	15
SM680	15
SM681	15
SM682	15
SM683	15
SM684	15
SM685	15
SM686	15
SM687	15
SM688	15
SM690C	15
SM691	15
SM692	15
SM700	17
SM701	17

Supco No.	Page No.
SM702	17
SM703	17
SM704	17
SM705	17
SM775	15
SM998	12 - 14
SM999	12
SO100	172
SP695	61
SP696	61
SP697	61
SP698	61
SP699	61
SP7232	61
SP7233	61
SP8345	61
SP9144	61
SP931WP	7
SPA12930	6
SPA1401AD	6
SPA1403FL	6
SPB1401F	6
SPD1401AM	6
SPF1111F	7
SPF17633	6
SPG1111GE	7
SPG1401GE	6
SPH52	37, 40 - 44
SPH53	37, 40 - 44
SPJ1111AM	7
SPK1401GE	6
SPL1111W	7
SPM10530	6
SPM6823-3	6
SPN1111AD	7
SPP	62
SPP10E	62
SPP1401WE	6
SPP4E	62
SPP5	62
SPP5E	62
SPP5TD	64
SPP5TD	62, 64
SPP6	62
SPP6E	62
SPP6TD	64
SPP7E	62
SPP7S	62
SPP8E	62
SPP9E	62
SR6N1	166
SRL130	114
SRL135	114
SRL220	114

Supco No.	Page No.
SRL230	114
SRL240	114
SRL250	114
SRL260	114
SRL300	114
SRL350	114
SRLF275VA	114
SRLF320VA	114
SS410	31
SSD4	88, 89
SSD4GE	80, 89
SSD50	89
SSD6	88, 89
SSD6GE	80, 89
SSD8GE	80, 89
SSDW100	77
SSDW7	77
SSDWK	77
ST01	154
ST02	154
ST03	154
ST04	154
ST06	154
ST07	154
ST08	154
ST09	154
ST10	154
ST200	172
STV2	30
STV2D	30
STV3	30
STV4	30
SU115	127
SU116	127
SU117	127
SU118	128
SU119	128
SU120	127
SU121	128
SU122	128
SU150	128
SU151	128
SU2001	36, 37, 40 - 44
SU2002	36, 37, 40 - 44
SU2003	36, 37, 40 - 44
SU2004	36, 37, 40 - 44
SU201	125
SU202	125
SU203	125
SU204	125
SU205	125
SU206	125
SU2101	36, 37, 40 to 44
SU2102	36, 37, 40 to 44

Supco No.	Page No.
SU2103	36, 37, 40 - 44
SU2104	36, 37, 40 - 44
SU2105	36, 37, 40 - 44
SU2106	36, 37, 40 - 44
SU2204	35, 38, 40 - 44
SU2213	35, 38, 40 - 44
SU2301	36, 37, 40 - 44
SU2302	36, 37, 40 - 44
SU2303	36, 37, 40 - 44
SU2304	36, 37, 40 - 44
SU301	126
SU302	126
SU303	126
SU304	126
SU305	126
SU306	126
SU348	127
SU359	127
SUD103	46
SUD109	46
SUD110	46
SUD111	46
SUD112	46
SUD113	46
SUD114	46
SUD115	46
SUPR	63
SW100	155
SW25	155
SW50	155
SW75	155
SWC02	167
SWC03	167
SWC04	167
SWC05	167
SWC06	167
SWC08	167
SWC110	167
SWC112	167
SWC116	167
SWC12	37, 40 - 44
SWC20	37, 40 - 44
SWC21	37, 40 - 44
SWC22	37, 40 - 44
SWC23	37, 40 - 44
SWC26	37, 40 - 44
SWC41	37, 40 - 44
SWC49	37, 40 - 44
SWC55	37, 40 - 44
SWC58	37, 40 - 44
SWC61	37, 40 - 44
SWC66	37, 40 - 44
SWCA1	167
SWE55	37, 40 - 44

Supco No.	Page No.
SWE58	37, 40 - 44
T1001	168
T1001C	168
T1002	168
T1002C	168
T1003	168
T1003C	168
T1004	168
T1004C	168
T1005	168
T1005C	168
T1006	168
T1006C	168
T1007	168
T1007C	168
T1008	168
T1008C	168
T1009	168
T1009C	168
T1010	168
T1010C	168
T1021	168
T1021C	168
T1022	168
T1022C	168
T1023	168
T1023C	168
T1027	168
T1027C	168
T1028	168
T1028C	168
T1029	168
T1029C	168
T1030	169
T1030C	169
T1031	169
T1031C	169
T1032	169
T1032C	169
T1033	169
T1033C	169
T1034	169
T1034C	169
T1035	169
T1035C	169
T1036	169
T1036C	169
T1037	169
T1037C	169
T1038	169
T1039	169
T1039C	169
T1040	169
T1040C	169

Supco No.	Page No.
T1042	169
T1042C	169
T1043	169
T1043C	169
T1044	169
T1044C	169
T1046	169
T1046C	169
T1047	169
T1047C	169
T1048	169
T1048C	169
T1049	169
T1049C	169
T1050	169
T1050C	169
T1051	170
T1051C	170
T1052	170
T1052C	170
T1053	170
T1053C	170
T1056	170
T1056C	170
T1057	170
T1057C	170
T1058	170
T1058C	170
T1059	170
T1059C	170
T1061	170
T1061C	170
T1062	170
T1062C	170
T1064	170
T1064C	170
T1065	170
T1065C	170
T1102	168
T1102C	168
T1103	168
T1103C	168
T1104	168
T1104C	168
T1105	168
T1105C	168
T1106	168
T1106C	168
T1107	168
T1107C	168
T1108	168
T1108C	168
T1109	169
T1109C	169

Supco No.	Page No.
T1110	168
T1110C	168
T1111	168
T1111C	168
T1112	168
T1112C	168
T1113	168
T1113C	168
T1114	169
T1114C	169
T1115	169
T1115C	169
T1116	169
T1116C	169
T1117	169
T1117C	169
T1118	169
T1118C	169
T1119	170
T1119C	170
T1120	169
T1120C	169
T1121	116, 170
T1121C	170
T1122	116, 170
T1122C	170
T1123	116, 170
T1123C	170
T1124	116, 170
T1124C	170
T1125	116, 170
T1125C	170
T1127	169
T1127C	169
T1129	170
T1129C	170
T1130	170
T1130C	170
T1131	169
T1131	169
T1131C	169
T1133	169
T1133C	169
T1134	169
T1134C	169
T1135	169
T1135C	169
T1136	169
T1136C	169
T1137	169
T1137C	169
T1138	169
T1138C	169
T1141	169

Supco No.	Page No.
T1141C	169
T1142	169
T1142C	169
T1143	169
T1143C	169
T1144	169
T1144C	169
T1145	170
T1145C	170
T1146	170
T1146C	170
T1147	170
T1147-50	170
T1150	168
T1150C	168
T1151	168
T1151C	168
T1152	168
T1152C	168
T1153	168
T1153C	168
T1161	168
T1161C	168
T1162	168
T1162C	168
T1163	168
T1163C	168
T1164	171
T1164C	171
T1165	171
T1165C	171
T1166	171
T1166C	171
T1167	171
T1167C	171
T1168	171
T1168L	171
T1169	171
T1169L	171
T1179	171
T1186	171
T1187	171
T1188	171
T1191	171
T1192	171
T1193	171
T1196	171
T1197	171
T2033	169
T2033C	169
T2065	169
T2065C	169
T2066	169
T2066C	169

Supco No.	Page No.
T1141C	169
T1142	169
T1142C	169
T1143	169
T1143C	169
T1144	169
T1144C	169
T1145	170
T1145C	170
T1146	170
T1146C	170
T1147	170
T1147-50	170
T1150	168
T1150C	168
T1151	168
T1151C	168
T1152	168
T1152C	168
T1153	168
T1153C	168
T1161	168
T1161C	168
T1162	168
T1162C	168
T1163	168
T1163C	168
T1164	171
T1164C	171
T1165	171
T1165C	171
T1166	171
T1166C	171
T1167	171
T1167C	171
T1168	171
T1168L	171
T1169	171
T1169L	171
T1179	171
T1186	171
T1187	171
T1188	171
T1191	171
T1192	171
T1193	171
T1196	171
T1197	171
T2033	169
T2033C	169
T2065	169
T2065C	169
T2066	169
T2066C	169

Supco No.	Page No.
T2067	171
T2067C	171
T2068	171
T2068C	171
T2070	171
T2070C	171
T2101	170
T2101C	170
T2111	170
T2111C	170
T2112	170
T2112C	170
T301025	143
T301225	143
T301425	143
T301625	143
T301825	143
TA2	155
TA2-220	155
TA2-220C	155
TA2C	155
TA2PROBE	155
TA3001	166
TA3P	155
TA4P	155
TA6	155
TA6220	155
TA6C	155
TA6C220	155
TA6PROBE	155
TA7	155
TA7C	155
TA7PROBE	155
TB123A	80
TC103	166
TC104	166
TC2	164
TCW100	155
TCW25	155
TCW50	155
TCW75	155
TDC22	64
TDP269	64
THC200	154
THP2	154
THS1441	166
THS60	166
TLA	157, 158
TPA1	157
TPFDA	153, 157, 158
TPFG	153, 157, 158
TPM110	154
TPM110C	154
TPM220C	154

Supco No.	Page No.
TPOC	153
TPP	153
TPS	153
UDA125	77
UFC1	164
UPRO22	32
UPRO41	32
UPRO42	32
UPRO62	32
UPRO81	32
UPRO82	32
UR230	32
URCO21	33
URCO22	33
URCO41	33
URCO42	33
URCO62	33
URCO81	33
URCO82	33
URO21	33
URO22	33
URO41	33
URO42	33
URO62	33
URO81	33
URO82	33
USBS	155
UW1	166
VI2404	46
WA100	156
WF270	29
WF271	29
WF282	29
WF284	30