

1527-48

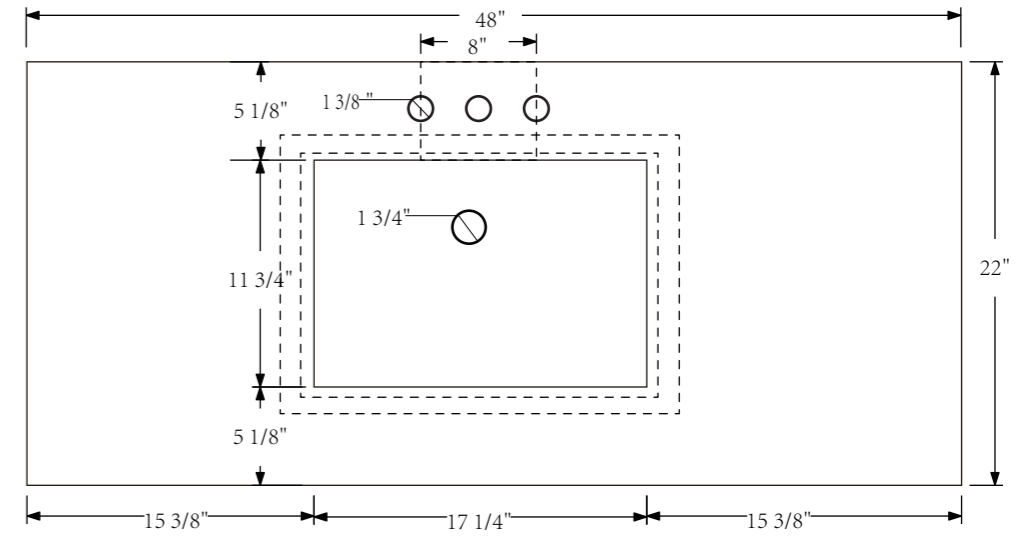

TOP VIEW

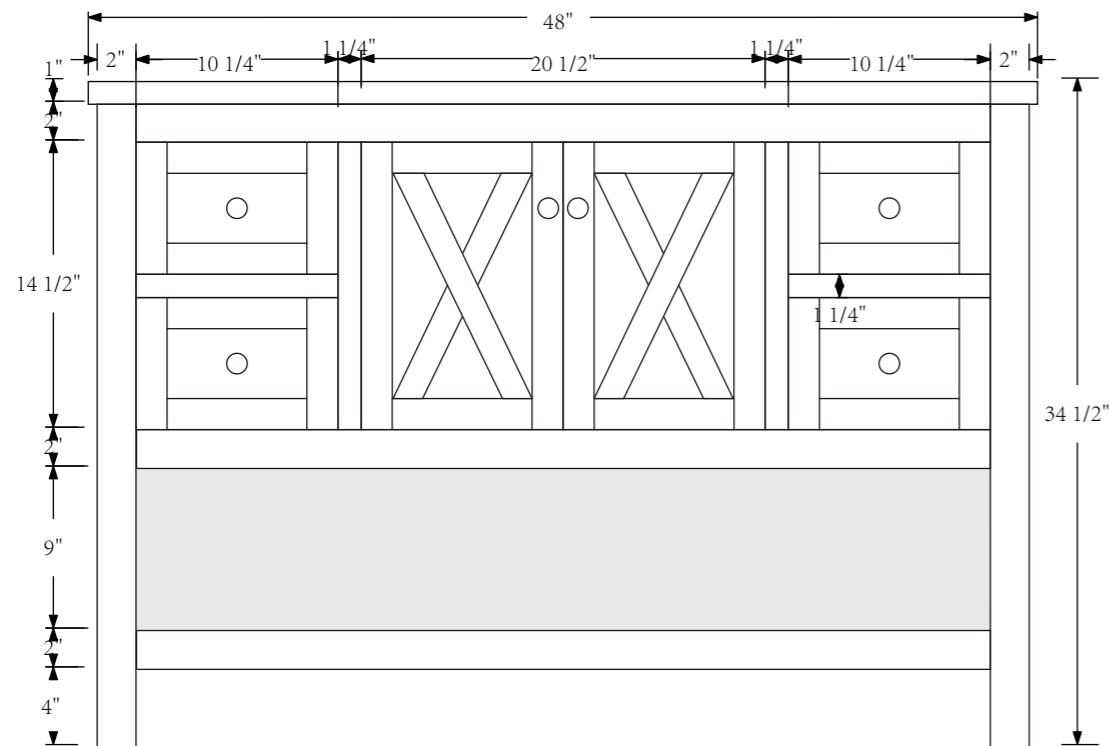

FRONT VIEW

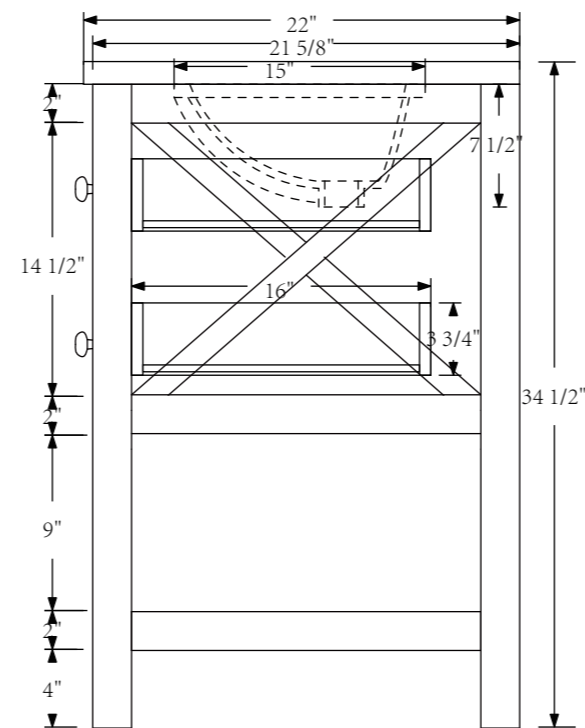

SIDE VIEW

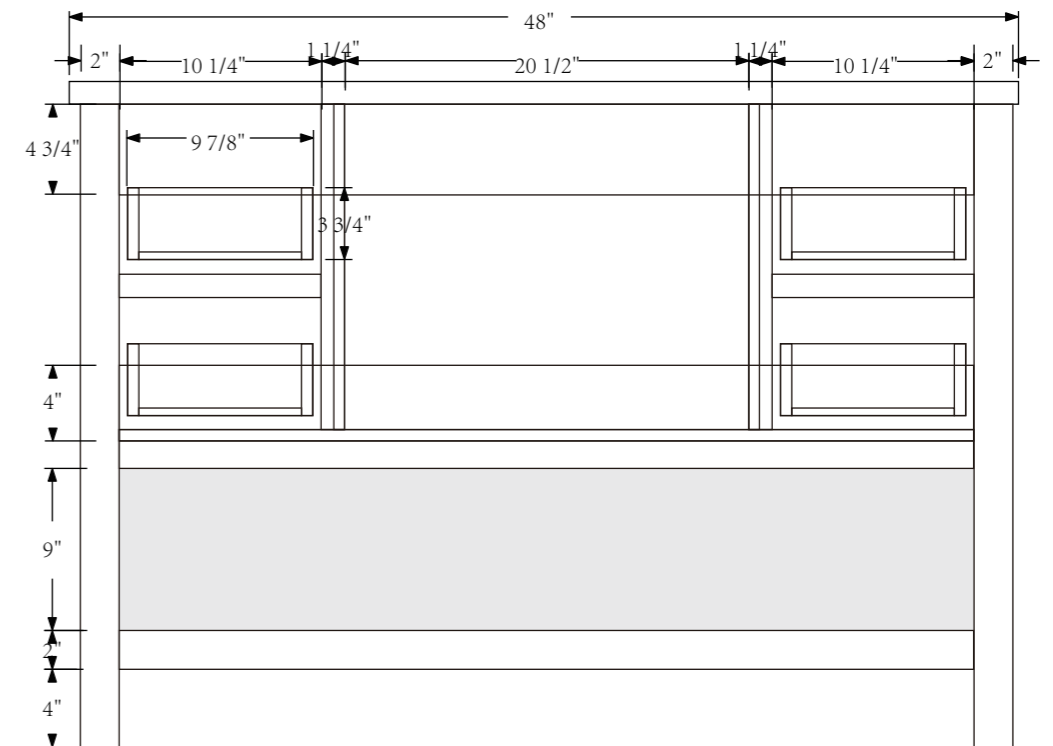

BACK VIEW