

WYNDHAM COLLECTION

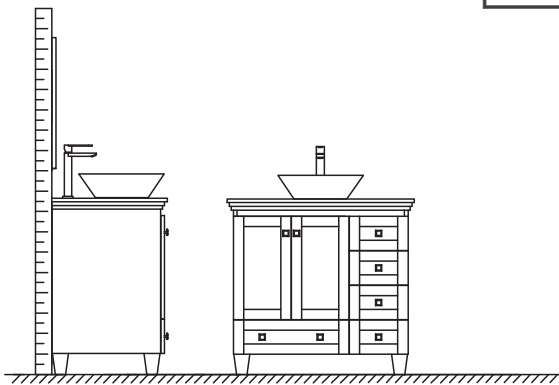

- Prior to installation, please check received items against the "Packing List".
- Please report any missing items to your retailer immediately
- Protect all surfaces from sharp objects, high heat sources, direct prolonged sunlight and chemical hazards.
- Professional installation recommended.

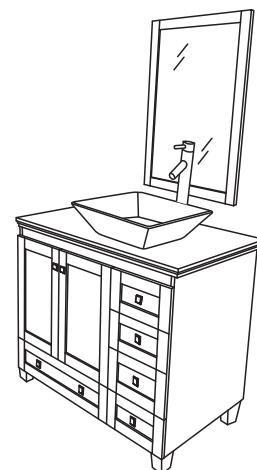

PACKING LIST

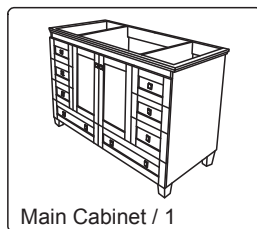

Main Cabinet / 1

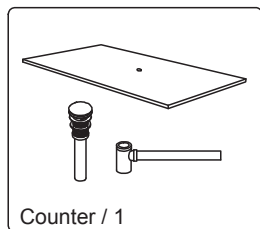

Counter / 1

OPTIONAL

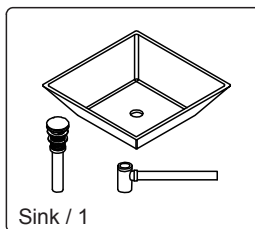

Sink / 1

OPTIONAL

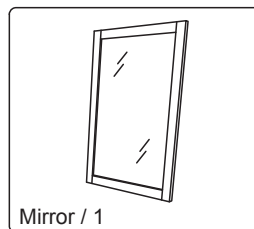

Mirror / 1

OPTIONAL



Installation screws for mirror / 2

INSTALLATION AND ADJUSTMENT OF HINGES

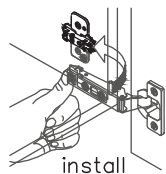

install

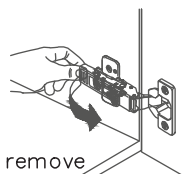

remove

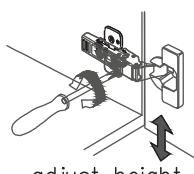

adjust height

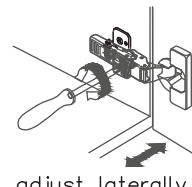

adjust laterally

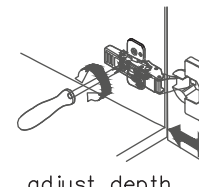

adjust depth

REQUIRED TOOLS NOT IN BOX



Tape measure



Pencil



Electric Drill

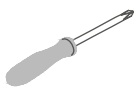

Phillips Screwdriver



Adjustable Wrench

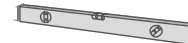

Spirit Level



Silicone sealant

WC-CG8000-48
OVERMOUNT INSTALLATION

WYNDHAM COLLECTION

INSTALLATION INSTRUCTIONS

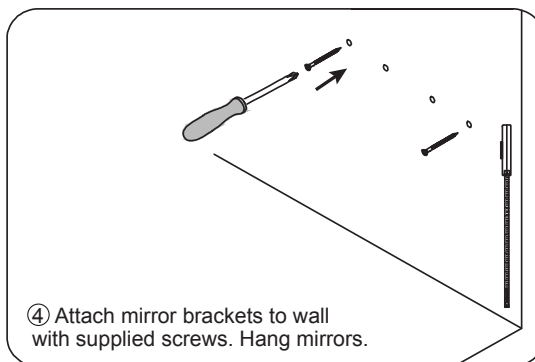
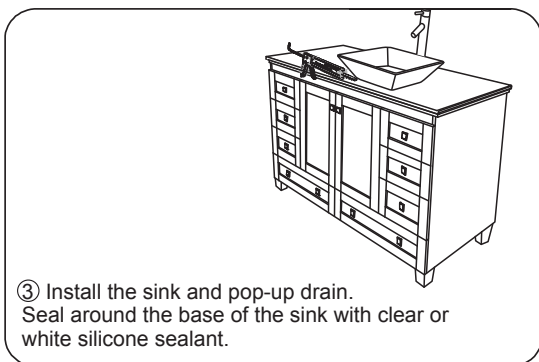
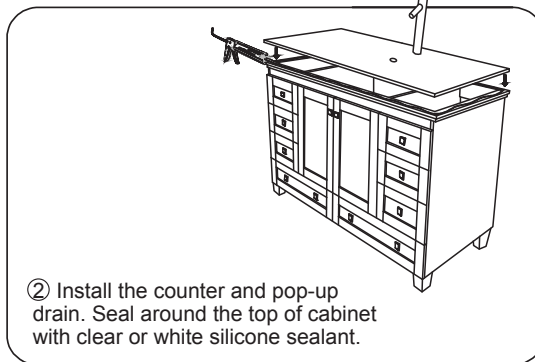
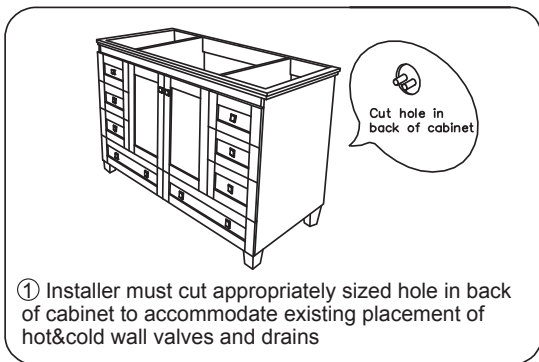

WC-CG8000-48
OVERMOUNT INSTALLATION