

Features

- Comfort Depth® design offers a convenient 19-inch step-over height while retaining the same depth as a standard 21-inch bath.
- Molded lumbar support and armrests offer extra comfort while bathing.
- Slotted overflow allows for deep soaking.
- Integral apron.
- Tile flange helps prevent water from seeping behind wall and simplifies alcove installation.
- Textured bottom surface
- Left-hand drain.
- Coordinates with other products in the Archer collection.

Material

- KOHLER ExoCrylic material offers 30% lighter product weight for easier installation.*
- 90% fewer VOCs* (volatile organic compounds) produced during manufacturing.
- *Compared to KOHLER® Brand Acrylic FRP

Installation

- Three-wall alcove.



ADA

Codes/Standards











CSA B45.5/IAPMO Z124
ADA
ICC/ANSI A117.1

Kohler One-Year Limited Warranty

See website for detailed warranty information.

Available Color/Finishes

Color tiles intended for reference only.

Color	Code	Description
	0	White
	96	Biscuit
	47	Almond
	NY	Dune
	95	Ice™ Grey
	G9	Sandbar
	33	Mexican Sand™
	K4	Cashmere
	58	Thunder™ Grey
	7	Black Black™

No change in measurements if connected with drain illustrated. (K-7272)

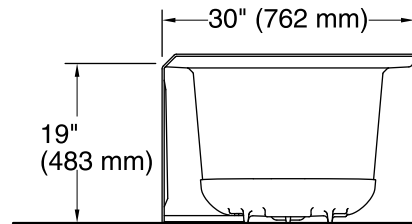
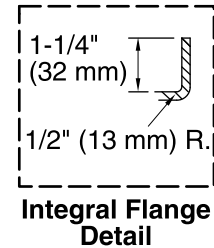
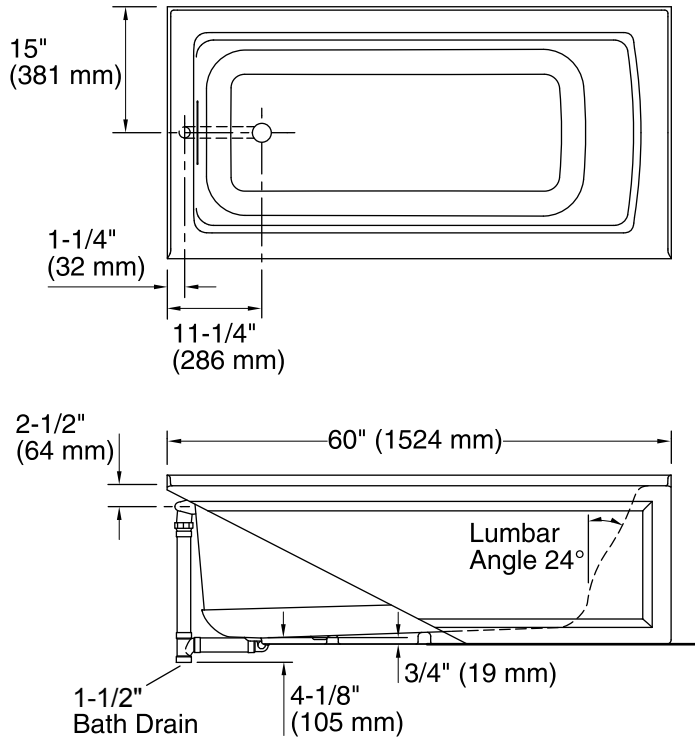

Technical Information

All product dimensions are nominal.

Installation:	3-Wall Alcove
Drain location:	Left
Basin area, bottom:	45-1/8" x 19-11/16" (1146 mm x 500 mm)
Basin area, top:	52-1/8" x 22-1/16" (1324 mm x 560 mm)
Weight:	73 lbs (33.1 kg)
Minimum floor load:	46 lbs/ft ² (224.6 kg/m ²)
Water depth:	15-1/8" (384 mm)
Water capacity:	57 gal (215.8 L)

Notes

Install this product according to the installation guide.

The hot water supply should be 70% of the capacity of the bath or greater. Installations will vary.

Will comply with ADA when installed per Section 607 Bathtubs of the Act.

ADA compliant when installed to the specific requirements of these regulations.