

Galanz

Model# GTWHG12BKSA10

ToastWave User Manual

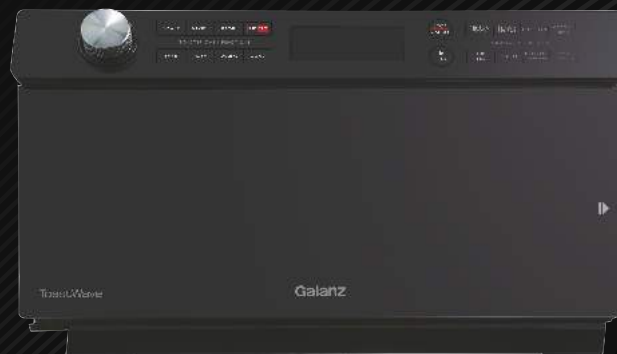

Thank you for purchasing a Galanz product. Please read this manual carefully for correct usage and safety, and keep for future reference. For service, support and warranty information, call 1-800-562-0738.

©2019 Galanz Americas Limited Company.

CONTENTS

Important Safety Instructions	1
Precautions to Avoid Possible Exposure to Excessive Microwave Technology	1
California Proposition 65 Warning	1
Warning	1
Grounding Instructions	3
Installation Guide	4
Cooking Utensils Guide	5
Product Diagram	6
Control Panel	7
First Time Use	8
Product Specifications	8
Operation Instructions	9
Setting the Clock	9
Timer	10
Quick Start Microwave	10
Microwave Cooking	11
Weight Defrost	12
Time Defrost	13
Toast	14
Bagel	15
Broil	16
Air Fry	18
Bake	20
Pizza	22
Warm	23
Convection	24
Sensor Cook	25
Sensor Reheat	26
Popcorn	27
+30 Sec Function	27
Turntable ON / OFF	28
Child Lock	28
Troubleshooting	29
Cleaning and Care	30
Product Warranty	31

IMPORTANT SAFETY INSTRUCTIONS

IMPORTANT SAFETY INSTRUCTIONS

PRECAUTIONS TO AVOID POSSIBLE EXPOSURE TO EXCESSIVE MICROWAVE TECHNOLOGY

- Do not attempt to operate this oven with the door open since open-door operation can result in harmful exposure to microwave technology. It is important not to tamper with the safety interlocks.
- Do not place any object between the oven front face and the door or allow soil or cleaner residue to accumulate on sealing surfaces.
- Do not operate the oven if it is damaged. It is very important that the oven door closes properly and that there is no damage to the
 - a) Door (including any dents),
 - b) Hinges and latches (broken or loosened),
 - c) Door seals and sealing surfaces.The oven should not be adjusted or repaired by anyone except qualified service personnel.

CALIFORNIA PROPOSITION 65 WARNING

WARNING

Cancer and Reproductive Harm-WWW.P65Warnings.ca.gov.

WARNING

To reduce the risk of burns, electric shock, fire, injury to persons or exposure to excessive microwave technology:

- Read all instructions before using the appliance.
- Read and follow the specific "PRECAUTIONS TO AVOID POSSIBLE EXPOSURE TO EXCESSIVE MICROWAVE TECHNOLOGY" on page 1.
- This appliance must be grounded. Connect only to properly grounded outlet. See "GROUNDING INSTRUCTIONS " on page 3.
- Do not operate the oven when empty.
- Install or locate this appliance only in accordance with the provided installation instructions.
- Some products such as whole eggs and sealed containers -for example, closed glass jars- are able to explode and should not be heated in this oven.
- Use this appliance only for its intended use as described in this manual. Do not use corrosive chemicals or vapors in this appliance. This type of oven is specifically designed to heat, cook, or dry food. It is not designed for industrial or laboratory use.
- As with any appliance, close supervision is necessary when used by children.
- To reduce the risk of fire in the oven cavity:
 - Do not overcook food. Carefully attend appliance when paper, plastic, or other combustible materials are placed inside the oven to facilitate cooking.
 - Remove wire twist-ties from paper or plastic bags before placing bag in oven.
 - If materials inside the oven should ignite, keep oven door closed, turn oven off using the circuit breaker panel, and call

SAVE THESE INSTRUCTIONS

IMPORTANT SAFETY INSTRUCTIONS

emergency services.

- Do not use the cavity for storage purposes. Do not leave paper products, cooking utensils or food in the cavity when not in use.
- Liquids, such as water, coffee, or tea are able to be overheated beyond the boiling point without appearing to be boiling due to surface tension of the liquid. Visible bubbling or boiling when the container is removed from the microwave oven is not always present. This could result in very hot liquids suddenly boiling over when a spoon or other utensil is inserted into the liquid.
- To reduce the risk of injury to person:
 - Do not overheat the liquid.
 - Stir the liquid both before and halfway through heating it.
 - Do not use straight-sided containers with narrow necks.
 - After heating, allow the container to stand in the microwave oven for a short time before removing the container.
 - Use extreme care when inserting a spoon or other utensil into the container.
- Do not heat oil or fat for deep-frying. It is difficult to control the temperature of oil in microwave oven.
- Do not cover or block any openings on the appliance.
- Do not operate this appliance if it has a damaged cord or a plug, if it is not working properly or if it has been damaged or dropped.
- Do not immerse cord or plug in water. Keep cord away from heated surface. Do not let cord hang over edge of table or counter.
- This appliance should be serviced only by qualified service personnel, contact nearest authorized service facility for examination, repair, or adjustment.
- When cleaning surfaces of door and oven that comes together on closing the door, use only mild, nonabrasive soaps, or

detergents applied with a sponge or soft cloth.

- Oversized food or oversized metal utensils should not be inserted in a microwave/toaster oven as they may create a fire or risk of electric shock.
 - Do not store or use this appliance outdoors. Do not use this product near water, for example, near a kitchen sink, in a wet basement, near a swimming pool, or similar locations.
 - Do not clean with metal scouring pads. Pieces can burn off the pad and touch electrical parts involving a risk of electric shock.
 - Do not use paper products when appliance is operated in the toaster mode.
 - Do not store any materials, other than manufacturer's recommended accessories, in this oven when not in use.
 - Do not cover turntables, pans or any other part of the oven with metal foil. This will cause overheating of the oven.
 - This equipment has been tested and found to comply with Part 18 of the FCC Rules. Operation is subject to the following two conditions: (1) This device may not cause harmful interference, and (2) this device must accept any interference received, including interference that may cause undesired operation.
- CAUTION:** Changes or modifications not expressly approved by the party responsible for compliance could void the user's authority to operate the product. This equipment generates, uses and can radiate radio frequency energy and, if not installed and used in accordance with the instructions, may cause harmful interference to radio communications. However, there is no guarantee that interference will not occur in a particular

SAVE THESE INSTRUCTIONS

IMPORTANT SAFETY INSTRUCTIONS

installation. If this equipment does cause harmful interference to radio or television reception, which can be determined by turning the equipment off and on, the user is encouraged to try to correct the interference by one or more of the following measures:

- Reorient or relocate the receiving antenna.
- Increase the separation between the equipment and receiver.
- Connect the equipment into an outlet on a circuit different from that to which the receiver is connected.
- Consult the dealer or an experienced radio/TV technician for help.

GROUNDING INSTRUCTIONS

This appliance must be grounded. In the event of an electrical short circuit, grounding reduces risk of electric shock by providing an escape wire for the electric current. This appliance is equipped with a cord having a grounding wire with a grounding plug. The plug must be plugged into an outlet that is properly installed and grounded.

Consult a qualified electrician or serviceman if the grounding instructions are not completely understood, or if doubt exists as to whether the appliance is properly grounded, and if it is necessary to use an extension cord, use only a 3-wire extension cord that has a 3-blade grounding plug and a 3-slot receptacle that will accept the plug on the appliance. The marked rating of the extension cord shall be equal to or greater than the electrical rating of the appliance.

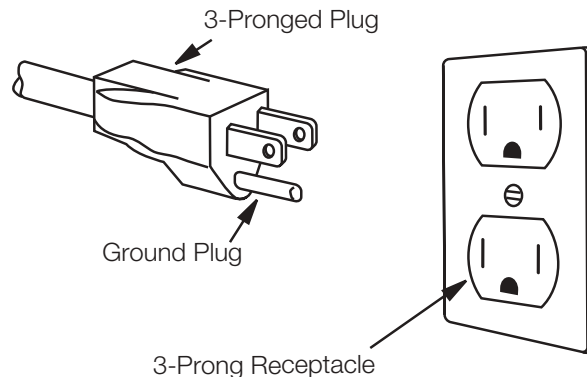

SAVE THESE INSTRUCTIONS

IMPORTANT SAFETY INSTRUCTIONS

Electrical Requirements

The electrical requirements are a 120 volt 60 Hz, AC only, 20 amp. It is recommended that a separate circuit serving only the oven be provided. The oven is equipped with a 3-prong grounding plug. It must be plugged into a wall outlet properly installed and ground.

Power Cord

—A short power supply cord is provided to reduce the risks resulting from becoming entangled in or tripping over a longer cord.

—Longer cord sets or extension cords are available and may be used if care is exercised in their use.

—If long cord or extension cord is used:

- The marked electrical rating of the cord set or extension cord should be at least as great as the electrical rating of the appliance.
- The extension cord must be a grounding-type 3-wire cord, and The longer cord should be arranged so that it will not drape over the countertop or tabletop where it can be pulled on by children or tripped over accidentally.

INSTALLATION GUIDE

- Make sure that all the packing materials are removed from the inside of the door.
- This microwave oven must be placed on a flat, stable surface.
- For correct operation, the oven must have sufficient airflow. Allow minimum 8 inch (20.32cm) of free space necessary above the top surface of the oven and 2 inch (5.08cm) at both sides. Do not cover or block any openings on the appliance. Do not remove feet.
- The appliance shall be only used on a countertop over 3 feet (91.44cm) above the floor.
- Do not place the oven where heat, moisture, or high humidity are generated, or near combustible materials.

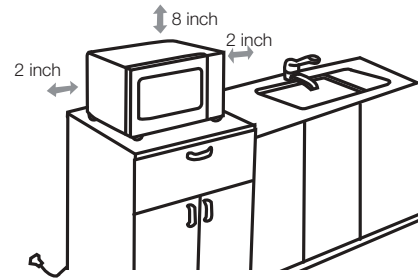

- Make sure that the power cord is undamaged and does not run under the oven or over any hot or sharp surface.
- The socket must be readily accessible so the microwave oven can be easily unplugged in an emergency.

SAVE THESE INSTRUCTIONS

IMPORTANT SAFETY INSTRUCTIONS

COOKING UTENSILS GUIDE



This section lists which utensils can be used in this microwave, which have limited use for short periods, and which should not be used in this microwave.

RECOMMENDED

Microwave browning dish — Use to brown the exterior of small items such as steaks, chops, or pancakes. Follow the directions provided with your browning dish.

Microwaveable plastic wrap — Use to retain steam. Leave a small opening for some steam to escape and avoid placing it directly on the food.

Paper towels and napkins — Use for short-term heating and covering; these absorb excess moisture and prevent spattering. Do not use recycled paper towels, which may contain metal and could ignite.

Glass and glass-ceramic bowls and dishes — Use for heating or cooking.

Paper plates and cups — Use for short-term heating at low temperatures. Do not use recycled paper, which contain metal and could ignite.

Wax paper — Use as a cover to prevent spattering.

Thermometers — Use only those labeled "Microwave Safe" and follow all directions. Check the food in several places. Conventional thermometers may be used on microwave food once the food has been removed from the oven.

LIMITED USE

Aluminum foil — Use narrow strips of foil to prevent overcooking of exposed areas. Using too much foil can damage your oven, so be careful. You should keep distance of 1 inch (2.54cm) between aluminum foil and cavity.

Ceramic, porcelain, and stoneware — Use these if they are labeled "Microwave Safe". If they are not labeled, test them to make sure they can be used safely.

Plastic — Use only if labeled "Microwave Safe". Other plastics can melt.

NOT RECOMMENDED

Glass jars and bottles — Regular glass is too thin to be used in a microwave. It can shatter and cause damage and injury.

Paper bags — These are a fire hazard, except for popcorn bags due on food.

Styrofoam plates and cups — These can melt and leave an unhealthy residue on food.

Plastic storage and food containers — Containers such as margarine tubs can melt in the microwave.

Metal utensils — These can damage your oven. Remove all metal before cooking.

Note:

Should you wish to check if a dish is safe for microwaving, place the empty dish in the oven and microwave at high power level for 30 seconds. A dish which becomes very hot should not be used.

SAVE THESE INSTRUCTIONS

PRODUCT DIAGRAM

1. Control Panel
2. Display Screen
3. Menu/Time/Weight/Temperature/Level Selector Knob
4. Oven Window
5. Top Heating Element
6. Bottom Heating Element
7. Convection Fan & Back Wall Heating Element
8. Non-stick Turntable
9. Shaft
10. Silicone Mat (Use this mat during microwave cooking)
11. Air Fry Kit
12. Wave Guide (Please do not remove the mica plate covering the wave guide)
13. Door Safety Lock System

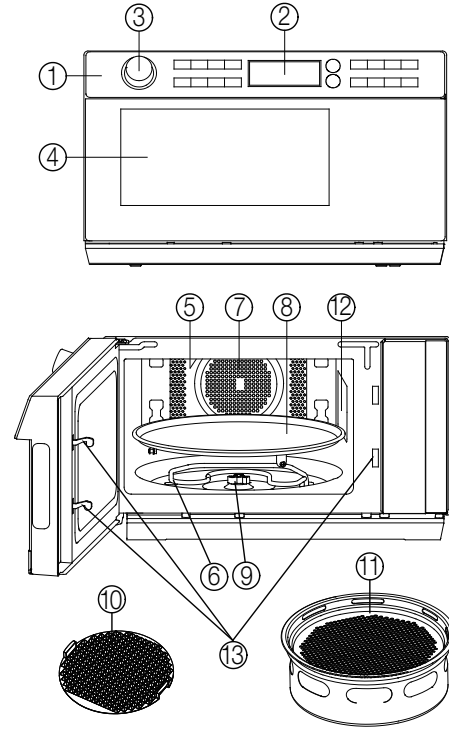

CONTROL PANEL



TOAST Use to toast bread (See Page 14).

BAGEL Use to toast bagel (See Page 15).

BROIL Use to broil food (See Page 16).

AIR FRY Use to air fry food (See Page 18).

BAKE Use to bake food (See Page 20).

PIZZA Use to bake pizza (See Page 22).

WARM Use to set keeping warm program (See Page 23).

CONV Use to set convection program (See Page 24).

SENSOR COOK

Use to set the automatic sensor cook programs (See Page 25).

SENSOR REHEAT

Use to set the automatic sensor reheat programs (See Page 26).

POPCORN

Use to set popcorn program (See Page 27).

CLOCK /TIMER

Press and hold to set the clock time (See Page 9).

Press to set the timer function (See Page 10).

+30 SEC

Press to add time during the cooking program (See Page 27).

MICRO

Use to microwave food with selected power level (See Page 11).

TIME / WEIGHT DEFROST

Press to set defrost program based on time (See Page 13).

Press to set defrost program based on weight (See Page 12).

LOCK / TURNTABLE OFF

Press and hold to set child lock (See Page 28).

Press to turn turntable on or off while in the microwave cooking mode (See Page 28).

STOP / CANCEL

Press to clear all previous settings before cooking starts.

Press once to pause current cooking program or press twice to cancel the program.

START

Press to confirm or start cooking program.

Menu / Time / Weight / Temperature / Level Selector Knob

Turn to select cooking menus, time, food weight, portion, temperature, darkness or power level.

FIRST TIME USE

If you are using your ToastWave for the first time, please be sure to:

- Clean the non-stick turntable, silicone mat and air fry kit with hot water, a small amount of dishwashing liquid and a nonabrasive cleaning pad.
- Do not immerse the body of the unit in water.
- When you plug in the unit, the display will show "12:00".
- While you are in the process of any setting, the oven will return to standby mode after 20 seconds without any operation.
- During cooking, if press **STOP/CANCEL** once or open the door, the program will be paused. Press the dial or **START** to resume cooking, but if you press **STOP/CANCEL** twice, the program will be canceled.
- When the cooking completes, the screen will display "End" with sound every two minutes until you press **STOP/CANCEL** or open the door.

NOTE: During initial start up you may detect a slight smell and/or smoke. Use Convection function at 425 °F without food and let run for approximately 15 minutes.

Product Specifications

Power supply	120V/60Hz
Power Consumption (Microwave)	1050W
Power Consumption (Convection)	1450W
Rated Microwave Power Output	1000W
Operating Frequency	2450MHz
Outside Dimensions (W x H x D)	21 1/4 x 12 9/16 x 22 1/4 inch
Oven Cavity Dimensions (W x H x D)	14 3/4 x 9 1/16 x 15 1/8 inch
Oven Capacity	1.2 Cu.Ft.
Net Weight	Approx. 40.23 lbs

OPERATION INSTRUCTIONS

Setting the Clock

You can set the clock in 12-hour or 24-hour by pressing **CLOCK/TIMER** in standby mode.

Example: How to set a 12-hour clock at 11:58.

- 1** In standby mode, press and hold **CLOCK/TIMER** for 3 seconds to select 12-hour clock (press the pad again to select 24-hour clock).

CLOCK **00:00**

CLOCK
TIMER

- 2** Turn the dial until the correct hour is displayed.



CLOCK **00:00**

- 3** Press the dial or **START** or **CLOCK/TIMER** to confirm the hour.



CLOCK **00:00**

- 4** Turn the dial until the correct minute is displayed.

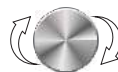

CLOCK **00:58**

- 5** Press the dial or **START** or **CLOCK/TIMER** to confirm the minute and finish setting.



00:58

NOTE: While in the process of setting the clock, you can cancel the settings by pressing the **STOP/CANCEL**.

OPERATION INSTRUCTIONS

Timer



You can use the timer feature to count down a specific amount of time whether it's for cooking or for anything else.

Example: How to set the timer for 3 minutes and 50 seconds.

1 Press CLOCK/TIMER once.	
2 Turn the dial to enter the time. The maximum time you can set is 95 minutes.	
3 Press the dial or START to confirm and start countdown.	

NOTE: Timer countdown can be seen for 5 seconds by touching **CLOCK/TIMER**, if press **STOP/CANCEL** during these 5 seconds, the timer will be canceled.

Quick Start Microwave



Accessory Guide: Non-stick Turntable

Silicone Mat



This feature allows you to start the oven quickly at maximum microwave power. The longest cooking time is 95 minutes.

Example: How to quick start microwave for 3 minutes and 50 seconds.

1 In standby mode, turn the dial to enter the time.	
2 Press the dial or START to confirm and start cooking.	

OPERATION INSTRUCTIONS

Microwave Cooking



Accessory Guide: Non-stick Turntable

Silicone Mat



This feature allows you to choose the power level and cooking time of microwave function. The longest cooking time is 95 minutes.

Example: How to cook at 30% power level for 3 minutes and 50 seconds.

- 1** Press **MICRO** pad once, the default power level is 100% (maximum power).

MICRO

00:00
MICRO

- 2** Turn the dial to select the 30% power level.



00:30
MICRO

- 3** Press the dial or **START** once to confirm the power level.

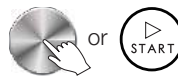

00:00
MICRO

- 4** Turn the dial again to enter cooking time.



00:50
MICRO

- 5** Press the dial to confirm and start cooking.

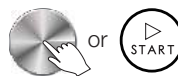

00:50
MICRO 

Power Level Chart:

Power Level	Display	Power Level	Display
100%	P100	40%	P-40
90%	P-90	30%	P-30
80%	P-80	20%	P-20
70%	P-70	10%	P-10
60%	P-60	0%	P-00
50%	P-50		

OPERATION INSTRUCTIONS

Weight Defrost

Accessory Guide: Non-stick Turntable

Silicone Mat

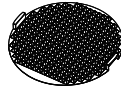

The defrosting time and power level are automatically set once the food category and the weight are selected.

Example: How to defrost 8oz seafood.

1 In standby mode, press the **TIME/WEIGHT DEFROST** twice.



88:88 DEF

2 Turn the dial to select food code 'dEF3' (Seafood).



88:88 DEF

3 Press the dial or **START** once to confirm the food type.

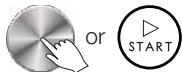

88:88 OZ DEF

4 Turn the dial to select the food weight.



88:88 OZ DEF

5 Press the dial or **START** once to confirm and start defrosting.



88:88 Cooking DEF

Weight Defrost Food Chart:

Code	Food	Maximum Weight
dEF1	Meat	48oz
dEF2	Poultry	48oz
dEF3	Seafood	32oz

NOTE:

During the defrosting program, the system will pause and alert the user to turn the food over when 1/3 of the defrosting time remains. After turning food over, close the door and press the dial or **START** to resume the defrosting.

OPERATION INSTRUCTIONS

Weight must be in pounds and ounces. If label gives weight in pounds only, change the fraction of a pound to ounces using the following chart.

Converting fractions of a pound to ounces:

Fractions of a pound	Ounces	Fractions of a pound	Ounces
Less than .03	0	.54 to .59	9
.03 to .09	1	.60 to .65	10
.10 to .15	2	.66 to .71	11
.16 to .21	3	.72 to .78	12
.22 to .27	4	.79 to .84	13
.28 to .34	5	.85 to .90	14
.35 to .40	6	.91 to .97	15
.41 to .46	7	.97 to .99	16
.47 to .53	8		

Time Defrost



Accessory Guide: Non-stick Turntable



Silicone Mat



The defrosting power is adjusted automatically once the cooking time is programmed.

Example: How to defrost food for 3 minutes and 50 seconds.

- In standby mode, press the **TIME/WEIGHT DEFROST** once.



88:00

DEF

- Turn the dial to select the defrosting time.

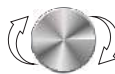

88:50

DEF

- Press the dial or **START** once to confirm and start defrosting.

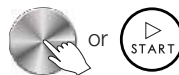

88:50



NOTE:

During the defrosting program, the system will pause and alert the user to turn the food over when 1/3 of the defrosting time remains. After turning food over, close the door and press the dial or **START** to resume the defrosting.

OPERATION INSTRUCTIONS

Toast



Accessory Guide: Non-stick Turntable



For Toast function, 1 to 6 slices and three levels of darkness can be selected.

Example: How to toast 6 slices bread to the dark level.

1 In standby mode, press the **TOAST** once.

TOAST

TOAST AUTO
48:00

2 Turn the dial to select the slices of bread.



TOAST AUTO
88:00

3 Press the dial or **START** once to confirm the slice.



TOAST AUTO
88:00

4 Turn the dial to select the level of darkness '3' (Dark).



TOAST AUTO
88:00

5 Press the dial or **START** once to confirm and start cooking.



TOAST AUTO
88:20
Cooking

Toast Cooking Chart:

Code	Level	Longest Cooking Time	Code	Level	Longest Cooking Time
1-PC (1 Slice)	1-Light	4:20	4-PC (4 Slices)	1-Light	5:00
	2-Medium	5:00		2-Medium	5:30
	3-Dark	5:40		3-Dark	5:50
2-PC (2 Slices)	1-Light	4:30	5-PC (5 Slices)	1-Light	5:00
	2-Medium	5:10		2-Medium	5:50
	3-Dark	5:40		3-Dark	6:10
3-PC (3 Slices)	1-Light	4:40	6-PC (6 Slices)	1-Light	5:10
	2-Medium	5:10		2-Medium	6:00
	3-Dark	5:50		3-Dark	6:20

NOTE:

- You can use **+30 SEC** to add time when cooking finishes, up to 2 minutes.
- Cooking time may vary based on the cavity temperature.

OPERATION INSTRUCTIONS

Bagel



Accessory Guide: Non-stick Turntable



For Bagel function, three levels of darkness can be selected. Cut-side-up is recommended.

Example: How to toast the bagel to the level of Dark.

1 In standby mode, press the **BAGEL** once.

BAGEL

BAGEL

AUTO

88:88

2 Turn the dial to select the level of darkness '3' (Dark).



BAGEL

AUTO

88:88

3 Press the dial or **START** once to confirm and start cooking.



BAGEL

AUTO

80:00



Cooking

Bagel Cooking Chart:

Code	Level	Cooking Time
1	Light	6:00
2	Medium	8:00
3	Dark	10:00

NOTE:

You can use **+30 SEC** to add time when cooking finishes, up to 2 minutes.

OPERATION INSTRUCTIONS

Broil



Accessory Guide: Non-stick Turntable



For Broil cooking, you can select the type of food you want to cook from the programs listed on the cooking label located on the interior panel of the appliance.

Auto Program: How to broil 16oz salmon filet.

- 1** In standby mode, press the **BROIL** twice to use auto program.

BROIL x 2

BROIL AUTO
88:88

- 2** Turn the dial to select food code 'Ar-3' (Salmon Filet).



BROIL AUTO
88:88

- 3** Press the dial or **START** once to confirm food code.

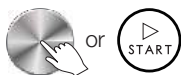

BROIL AUTO
88:88 OZ

- 4** Turn the dial to select food weight.

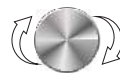

BROIL AUTO
88:88 OZ

- 5** Press the dial or **START** once to confirm and start cooking.



BROIL AUTO
22:00
Cooking

Broil Food Chart (Auto Program):

Code	Food	Weight	Cooking Time
Ar-1	Pork Chop	6oz	18:00
		12oz	20:00
		18oz	22:00
		24oz	24:00
Ar-2	Steak	8oz	18:00
		12oz	20:00
		16oz	22:00
Ar-3	Salmon Filet	4oz	16:00
		8oz	18:00
		12oz	20:00
		16oz	22:00
		20oz	24:00

OPERATION INSTRUCTIONS

Custom Program: How to set Broil by choosing time and temperature (425°F for 20 minutes).

- 1** In standby mode, press the **BROIL** once to use custom setting (Default is 400 °F).

BROIL

BROIL
40:00

- 2** Turn the dial to select the temperature 425 °F.



BROIL
42:58

- 3** Press the dial or **START** once to confirm the temperature.

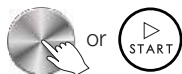

BROIL
00:00

- 4** Turn the dial to set cooking time.



BROIL
20:00

- 5** Press the dial or **START** once to confirm and start cooking.

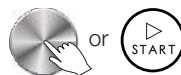

BROIL
20:00



Cooking

NOTE:

- It can be programmed for four different temperatures. They are: 400°F(default) → 425°F → 350°F → 375°F.
- The longest cooking time is 95 minutes.

OPERATION INSTRUCTIONS

Air Fry



Accessory Guide: Non-stick Turntable



Air Fry Kit



For Air Fry cooking, you can select the type of food you want to cook from the programs listed on the cooking label located on the interior panel of the appliance.

Auto Program: How to air fry 16oz chicken wings.

1 In standby mode, press the **AIR FRY** twice to use auto program.

AIR FRY x 2

AIRFRY AUTO
88:88

2 Turn the dial to select food code 'AF-3' (Chicken Wings).



AIRFRY AUTO
88:88

3 Press the dial or **START** once to confirm food code.



AIRFRY AUTO
88:88 OZ

4 Turn the dial to select food weight.

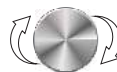

AIRFRY AUTO
88:88 OZ

5 Press the dial or **START** to confirm and start cooking.

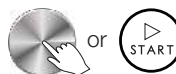

AIRFRY AUTO
40:00
Cooking



OPERATION INSTRUCTIONS



Air Fry Food Chart (Auto Program):



Code	Food	Weight	Cooking Time
AF-1	Onion Rings	8oz	20:00
AF-2	Chicken Drumsticks	8oz	36:00
		12oz	39:00
		16oz	42:00
		20oz	45:00
AF-3	Chicken Wings	8oz	36:00
		12oz	38:00
		16oz	40:00
AF-4	Chicken Nuggets	6oz	24:00
		8oz	26:00
		10oz	28:00
AF-5	Popcorn Chicken	12oz	30:00
		8oz	26:00
		10oz	28:00
		16oz	32:00
AF-6	Mozzarella Sticks	6oz	13:00
		8oz	14:00
		10oz	15:00
		12oz	16:00
		14oz	17:00
AF-7	French Fries	16oz	18:00
		10oz	30:00



Custom Program: How to set AirFry by choosing time and temperature (400°F for 30 minutes).

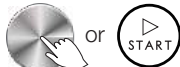

- In standby mode, press the **AIR FRY** once to use custom setting (Default is 425 °F).



- Turn the dial to select the temperature 400 °F.



- Press the dial or **START** once to confirm the temperature.



- Turn the dial to set cooking time.



- Press the dial or **START** once to confirm and start cooking.

NOTE: ■ It can be programmed for four different temperatures. They are: 425°F(default) → 350°F → 375°F → 400°F.
 ■ The longest cooking time is 95 minutes.

OPERATION INSTRUCTIONS

Bake



Accessory Guide: Non-stick Turntable



For Bake, you can select the type of food you want to cook from the programs listed on the cooking label located on the interior panel of the appliance.

Auto Program: How to bake a 9-inch cake.

1 In standby mode, press **BAKE** twice to use auto program.

BAKE x 2

PREH AUTO
BAKE 88:88

2 Turn the dial to select food code 'Ab-3' (Cake).



PREH AUTO
BAKE 88:88

3 Press the dial or **START** to confirm and start preheating.



PREH AUTO
BAKE 35:00

4 When preheating finishes, 'PREH' will stop blinking and the oven will show 'Add Food 350F' and sound periodically to remind user to put the food inside.

8888 → 8888 → 350F

PREH AUTO
BAKE 35:00

5 Open the oven door, the display will show the cooking time, and then place food into the oven. Close the oven door.

PREH AUTO
BAKE 88:00

6 Press the dial or **START** once to confirm and start cooking.

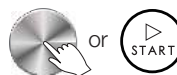

PREH AUTO
BAKE 88:00

Cooking

Bake Food Chart (Auto Program):

Code	Food	Portion	Preheating Temperature	Cooking Time
Ab-1	Cookies	7 Cookies	350°F	12:00
Ab-2	Brownies	9 x 9 inch	350°F	40:00
Ab-3	Cake	9 inch	350°F	18:00

OPERATION INSTRUCTIONS

Custom Program: How to set Bake by choosing time and temperature (400°F for 25 minutes).

1 In standby mode, press **BAKE** once to use custom setting (Default is 350 °F).



PREH 35:00
BAKE

2 Turn the dial to select the preheating and cooking temperature.



PREH 40:00
BAKE

3 Press the dial or **START** to confirm the temperature.

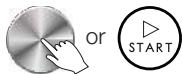

PREH 88:00
BAKE

4 Turn the dial to select cooking time.



PREH 25:00
BAKE

5 Press the dial or **START** to confirm the cooking time and start preheating.



PREH 40:00
BAKE

6 When preheating finishes, 'PREH' will stop blinking and the oven will show 'Add Food 400F' and sound periodically to remind user to put the food inside.

8888 → F888 → 400F

PREH 40:00
BAKE

7 Open the oven door, the display will show the cooking time, and then place food into the oven. Close the oven door.

25:00
BAKE

8 Press the dial or **START** once to confirm and start cooking.

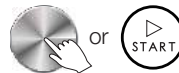

25:00
BAKE 

NOTE:

- It can be programmed for four different temperatures. They are: 350°F(default) → 375°F → 400°F → 325°F.
- The longest cooking time is 95 minutes.

OPERATION INSTRUCTIONS

Pizza





Accessory Guide: Non-stick Turntable

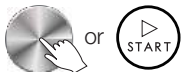

For Pizza function, this oven may cook faster than the traditional oven, please be careful when your first time to use this function.

Custom Program: How to bake pizza with 425°F in 40 minutes.

<p>1 In standby mode, press PIZZA once to use custom setting (Default is 400 °F).</p> <p>PIZZA</p>	<p>PREH 40:00</p> <p>PIZZA</p>
<p>2 Turn the dial to select the preheating and cooking temperature .</p> 	<p>PREH 425F</p> <p>PIZZA</p>
<p>3 Press the dial or START to confirm the temperature.</p> 	<p>PREH 88:00</p> <p>PIZZA</p>
<p>4 Turn the dial to select cooking time.</p> 	<p>PREH 40:00</p> <p>PIZZA</p>

5 Press the dial or **START** to confirm the cooking time and start preheating.



PREH 425F
PIZZA

6 When preheating finishes, 'PREH' will stop blinking and the oven will show 'Add Food 425F' and sound periodically to remind user to put the food inside.

Add → Food → 425F

PREH 425F
PIZZA

7 Open the oven door, the display will show the cooking time, and then place food into the oven. Close the oven door.

40:00
PIZZA

8 Press the dial or **START** once to confirm and start cooking.



40:00	
PIZZA	Cooking

NOTE:

- It can be programmed for four different temperatures. They are: 400°F(default) → 425°F → 350°F → 375°F.
- The longest cooking time is 95 minutes.

OPERATION INSTRUCTIONS

Warm



Accessory Guide: Non-stick Turntable



Use this function to keep your food warm.

Example: How to Warm with temperature 180°F for 11 minutes.

1 In standby mode, press the **WARM** pad once, the default temperature is 170 °F.

WARM

17:00
WARM

2 Turn the dial to select the temperature.



18:00
WARM

3 Press the dial or **START** once to confirm the temperature.

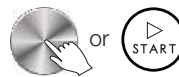

11:00
WARM

4 Turn the dial to select cooking time.



11:00
WARM

5 Press the dial or **START** once to confirm and start cooking.

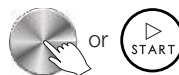

11:00
WARM
Cooking

NOTE:

- It can be programmed for five different temperatures. They are: 170°F(default) → 180°F → 190°F → 200°F → 160°F.
- The longest cooking time is 95 minutes.

OPERATION INSTRUCTIONS

Convection



Accessory Guide: Non-stick Turntable



This feature allows you cook with powerful convection. During convection cooking, hot air is circulated throughout the oven cavity to brown and crisp foods quickly and evenly.

Example: How to cook with convection temperature 425°F for 30 minutes.

<p>1 In standby mode, press CONV once to use custom setting (Default is 350°F).</p>	
<p>2 Turn the dial to select the preheating and cooking temperature.</p>	
<p>3 Press the dial or START once to confirm the temperature.</p>	
<p>4 Turn the dial to select cooking time.</p>	

5 Press the dial or **START** once to confirm the cooking time and start preheating.



--

6 When preheating finishes, 'PREH' will stop blinking and the oven will show 'Add Food 425F' and sound periodically to remind user to put the food inside.

8888 → F888 → 425F

--

7 Open the oven door, the display will show the cooking time, and then place food into the oven. Close the oven door.

--

8 Press the dial or **START** once to confirm and start cooking.

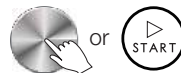

	<p>Cooking</p>
--	----------------

NOTE:

- It can be programmed for 11 different temperatures. They are: 350°F(default) → 375°F → 400°F → 425°F → 175°F → 200°F → 225°F → 250°F → 275°F → 300°F → 325°F.
- The longest cooking time is 95 minutes.

OPERATION INSTRUCTIONS

Sensor Cook



Accessory Guide: Non-stick Turntable Silicone Mat



For sensor cook function, you can select the type of food you want to cook from the programs listed on the cooking label located on the interior panel of the appliance.

Auto Program: How to Cook 8oz fresh vegetable with sensor.

1 In standby mode, press the **SENSOR COOK** once to use auto program.

SENSOR
COOK

SENSOR
99:99

2 Turn the dial to select food code 'SC-3' (Fresh Vegetable).



SENSOR
99:99

3 Press the dial or **START** once and start sensing and cooking.

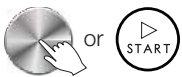

SENSOR
99:99
MICRO
Cooking

4 The appliance will automatically suggest a cooking time and start countdown.

SENSOR
88:30
MICRO
Cooking

Sensor Cook Food Chart (Auto Program):

Code	Food	Weight Range
SC-1	Potato	6-24oz
SC-2	Beverage	8oz/10oz/12oz
SC-3	Fresh Vegetable	7-21oz
SC-4	Frozen Vegetable	7-21oz
SC-5	Frozen Pizza	5-16oz
SC-6	Oatmeal	5-16oz

NOTE:

- After cooking for a period of time, the system will detect whether there is error, if there is error, for example, the sensor short circuit or open circuit, the system will stop automatically with the display showing "Er60", beeps sound until press **STOP/CANCEL** pad.
- If there is no error, the system will judge corresponding cooking time based on the steam generated by the food, after cooking for a period of time, the countdown will display on the screen.
- During sensor cooking program, if press **STOP/CANCEL** pad once or open the door, the system will turn back to standby mode.
- If during the longest sensor time the oven cannot judge the cooking time according the steam produced by food in the cavity, the cooking will auto-end.

OPERATION INSTRUCTIONS

Sensor Reheat



Accessory Guide : Non-stick Turntable Silicone Mat



For sensor reheat function, you can select the type of food you want to cook from the programs listed on the cooking label located on the interior panel of the appliance.

Auto Program: How to Reheat soup with sensor.

- 1** In standby mode, press the **SENSOR REHEAT** once.

SENSOR
REHEAT

SENSOR
58:00

- 2** Turn the dial to select food code 'SH-3' (Soup).



SENSOR
58:03

- 3** Press the dial or **START** once and start sensing and cooking.

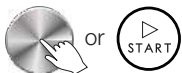

SENSOR
58:03
MICRO
Cooking

- 4** The appliance will automatically suggest a cooking time and start countdown.

SENSOR
88:30
MICRO
Cooking

Sensor Reheat Food Chart (Auto Program) :

Code	Food	Weight Range
SH-1	Frozen Entrée	7-24oz
SH-2	Dinner Plate	5-24oz
SH-3	Soup / Sauce	5-24oz
SH-4	Chili	5-24oz
SH-5	Pasta	5-24oz
SH-6	Mac and Cheese	5-24oz
SH-7	Mashed Potatoes	5-24oz
SH-8	Rice	5-28oz

NOTE:

- After cooking for a period of time, the system will detect whether there is error, if there is error, for example, the sensor short circuit or open circuit, the system will stop automatically with the display showing "Er60", beeps sound until press **STOP/CANCEL** pad.
- If there is no error, the system will judge corresponding cooking time based on the steam generated by the food, after cooking for a period of time, the countdown will display on the screen.
- During sensor cooking program, if press **STOP/CANCEL** pad once or open the door, the system will turn back to standby mode.
- If during the longest sensor time the oven cannot judge the cooking time according to the steam produced by food in the cavity, the cooking will auto-end.

OPERATION INSTRUCTIONS

Popcorn



Accessory Guide: Non-stick Turntable

Silicone Mat



Example: How to cook popcorn for 2 minutes and 30 seconds.

1 In standby mode, press **POPCORN** once. The default time is 2 minutes (For one bag around 3.2oz).

POPCORN

POPCORN
88:00

2 Turn the dial to select the cooking time.



POPCORN
88:30

3 Press the dial or **START** once to confirm and start cooking.

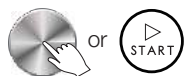

POPCORN
88:30
MICRO
Cooking

NOTE: The default time is 2 minutes. For default time, you can skip step 2, directly press the dial to start if you prefer.

+30 Sec Function



During cooking, you can add cooking time by touching **+30 SEC** pad repeatedly. The longest cooking time is 95 minutes.

Example: During microwave cooking, add the cooking time by 2 minutes by utilizing the +30 SEC button.

1 During cooking, suppose the display is showing 3:50.

83:50
MICRO
Cooking

2 Press **+30 SEC** 4 times.

+30
SEC x 4

89:50
MICRO
Cooking

NOTE:

Below programs cannot use **+30 SEC** during cooking.

- **SENSOR COOK**
- **SENSOR REHEAT**
- **POPCORN**
- **TIME / WEIGHT DEFROST**
- Auto menus of **BROIL / AIRFRY / BAKE**

TOAST and **BAGEL** can use **+30 SEC** to add time when cooking finishes, up to 2 minutes.

OPERATION INSTRUCTIONS

Turntable ON / OFF



The turntable is set to default as always turning. You can turn it on or off by pressing **LOCK/TURNTABLE OFF** during setting the Microwave program or during cooking in the Microwave program.

Example: How to set Turntable On/Off during MICRO programming.

1 During MICRO setting, suppose the display is showing 3:50.	

2 Press the LOCK/TURNTABLE OFF pad once, the turntable turns off.	

3 Press the LOCK/TURNTABLE OFF pad once again, the turntable turns on.	

Child Lock



The child proof lock prevents unsupervised operation by children.

Example1: How to set/cancel the child lock.

1 In standby mode, suppose the display is showing 11:58.	

2 Press and hold the LOCK/TURNTABLE OFF for 3 seconds, then 'LOCK' appears.	
Press and hold for 3 seconds.	

3 Press and hold the LOCK/TURNTABLE OFF for 3 seconds, then 'LOCK' disappears.	
Press and hold for 3 seconds.	

TROUBLESHOOTING

Automatic Protection Mechanism

OVERHEATING PROTECTION - The display may show Er10 which means the appliance has entered into high temperature overheat mode which will protect the appliance from further damage. Audible alert will be heard until **STOP/CANCEL** is pressed or the appliance is unplugged.

LOW TEMPERATURE PROTECTION - The display may show Er11 which means the appliance has entered into low temperature protection mode which will protect the appliance from further damage. Audible alert will be heard until **STOP/CANCEL** is pressed or the appliance is unplugged.

SENSOR MALFUNCTION PROTECTION - The display may show Er13 which means the appliance has entered into Sensor Malfunction protection mode which will protect the appliance from further damage. Audible alert will be heard until **STOP/CANCEL** is pressed or the appliance is unplugged.

CLEANING AND CARE

- Turn off the oven and unplug the power cord from the wall when cleaning.

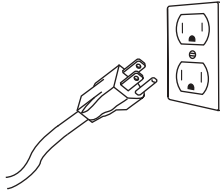

- Keep the inside of the oven clean. When food splatters or spilled liquids adhere to oven walls, wipe with a damp cloth. Mild detergents may be used if the oven gets very dirty. Avoid using spray or other harsh cleaners. They may stain, streak or dull the door surface.



- The outside of the oven should be cleaned with a damp cloth. To prevent damage to the operating parts inside the oven, water should not be allowed to seep into the ventilation openings.
- Wipe the door and window on both sides, the door seals and adjacent parts frequently with a damp cloth to remove any spills or splatters. Do not use abrasive cleaner.
- Do not allow the control panel to become wet. Clean with a soft, damp cloth. When cleaning the control panel, leave oven door open to prevent oven from accidentally turning on.

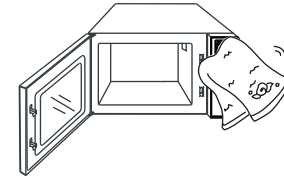

- If steam accumulates inside or around the outside of the oven door, wipe with a soft cloth. This may occur when the microwave oven is operated under high humidity condition. And it is normal.
- It is occasionally necessary to remove the non-stick turntable, silicone mat and air fry kit for cleaning. Wash them in warm sudsy water.

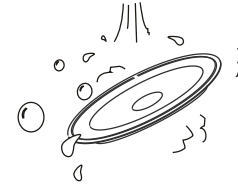

- If the light bulb burns out, please contact customer service to have it replaced.
- The oven should be cleaned regularly and any food deposits should be removed. Failure to maintain the oven in a clean condition could lead to deterioration of surface that could adversely affect the life of the unit and could possibly result in a hazardous situation.
- Please do not dispose of this appliance into the domestic rubbish bin; it should be disposed to the particular disposal center

PRODUCT WARRANTY

This warranty applies to products sold by Galanz Americas in the U.S. This warranty is in lieu of any other warranty and expressly applies to the individual product only.

Galanz product is warranted for one year following purchase for defects in material and workmanship. **Please save your receipt as proof of purchase is required to make a warranty claim.** During this period, we will provide the replacement cost of this product, a replacement or the equivalent, or repair per our discretion.

The warranty can not be transferred through resale, including the resale through a 3rd party unauthorized retailer and is only bestowed up on the original consumer purchaser upon purchase from an authorized retailer.

■ **This warranty does not cover and excludes damage or defects caused by:**

- Consumer misuse
- Abuse
- Neglect including the failure to clean and/or provide adequate regular maintenance as outlined in the user manual
- Commercial use
- Subjecting the product to any voltage outside the specified range
- Loss of parts
- The affixing of any attachments not provided with the product
- Accident
- Use in a manner not intended and outlined in the user manual.

■ Any subsequent damages caused by the above listed exclusions will not be covered and any claims determined to meet the above exclusions will be denied. All liability is limited to the purchase price and does not include any:

- Retail offered extended warranties
- Tax
- Other charges(including postage to send required materials)
- Incidental and/or consequential damages associated with the product in question.

Every implied warranty, including any statutory warranty of merchantability or fitness for a particular purpose is disclaimed except to the extent prohibited by law, in which case such warranty is limited to the duration of this written warranty. This warranty gives you specific legal rights. You may have other legal rights that vary depending on where you live. Some states do not allow limitations on implied warranties or special, incidental, or consequential damaged, so the above limitations may not apply to you.

If you have a claim under this warranty, please call our Customer Service number: 1-800-562-0738.

For faster service, please have the model number, serial number, and receipt ready for the operator to assist you.

WARRANTY REGISTRATION

Please mail this warranty card to the address below within 30 days of purchase.
Galanz Americas, 55 Challenger Road, Suite 503, Ridgefield Park, NJ 07660.

PLEASE PRINT CLEARLY.

Name _____

Address _____

City _____ State _____ ZIP _____

Phone _____ Email _____

Model Number _____ Serial Number _____

Purchase Location _____

You must attach a copy of your purchase receipt to validate your registration.

Galanz