

USE AND CARE GUIDE

ROUND PEDESTAL TABLE WITH BUBBLE BASE

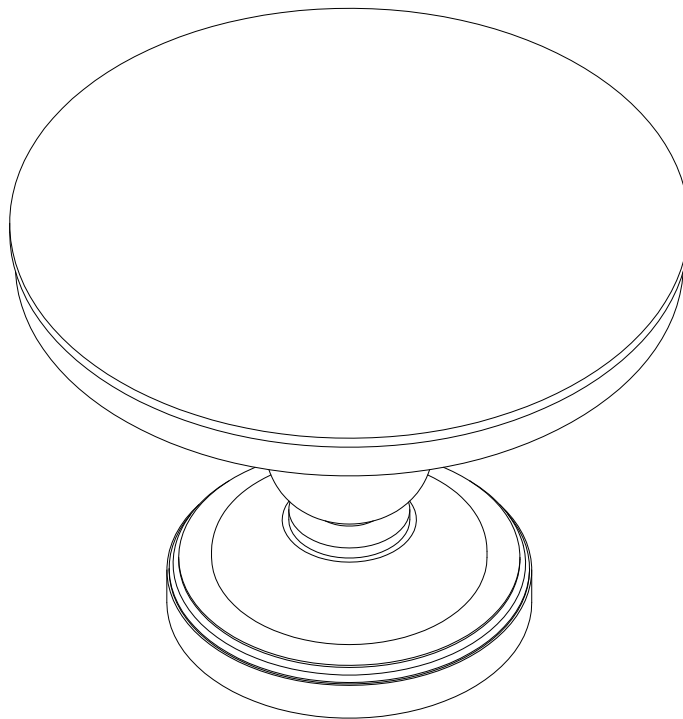

Questions, problems, missing parts? Before returning to the store,
call Home Decorators Collection Customer Service.
8 a.m. – 7 p.m., EST, Monday – Friday, 9 a.m. – 6 p.m., EST, Saturday

1-800-998-7021

HOMEDEPOT.COM/HOMEDECORATORS

THANK YOU

We appreciate the trust and confidence you have placed in Home Decorators Collection through the purchase of this Round Pedestal Table with Bubble Base. We strive to continually create quality products designed to enhance your home. Visit us online to see our full line of products available for your home improvement needs. Thank you for choosing Home Decorators Collection!

Table of Contents

Table of Contents.....	2	Tools Required.....	3
Safety Information.....	2	Hardware Included.....	3
Warranty.....	2	Pre-assembly (continued).....	4
3 Year Warranty.....	2	Package Contents.....	4
What is Covered.....	2	Assembly.....	5
What is Not Covered.....	2	Maintenance.....	7
Pre-assembly.....	3	Care and Cleaning.....	7
Planning Assembly.....	3		

Safety Information



DANGER

- Keep small parts away from children during assembly.
- Read and follow instructions carefully.



WARNING

- Read these instructions carefully and keep in a safe place.
- TO GUARANTEE THE SAFE USE OF THIS PRODUCT, FOLLOW THE WARNINGS, GUIDELINES AND RECOMMENDATIONS IN THIS MANUAL.
- Adult assembly required.
- Small parts may present choking hazard prior to assembly.



CAUTION

- Do not use power tools to assemble your furniture. Power tools may strip or damage parts/product.
- Do not overtighten connectors (screws, bolts, etc.). Overtightening can lead to product damage.
- Be sure to check all packing materials carefully for small parts that may have come loose inside the carton during shipment. If parts are missing, contact THE HOME DEPOT to obtain any missing parts.
- DO NOT USE SUBSTITUTE PARTS.
- This product should only be used on a flat, level surface.
- Some assembly may involve attaching glass or mirrors.
- Be very careful handling the glass or mirrors, as severe injury may result if the glass or mirror breaks.
- Never handle large pieces of glass or mirrors by yourself.
- Assembly requires two people; assembly alone may cause injury.

Warranty

3 YEAR WARRANTY

WHAT IS COVERED

We guarantee this product to be free of manufacturing defects to the original purchaser for three years.

WHAT IS NOT COVERED

This warranty does not cover commercial use, acts of nature, and abusive use.

Pre-assembly

PLANNING ASSEMBLY

This product has been designed for easy assembly and constructed for durability. All parts were checked prior to packaging to ensure quality. Prior to beginning assembly, however, make sure all parts and hardware are included and free of obvious defects. If a part is missing or defective, please contact the store where purchased.

TOOLS REQUIRED



Safety goggles



Level

HARDWARE INCLUDED



NOTE: Hardware not shown to actual size.



—AA



—BB



—CC

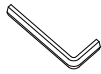

—DD



—EE

Part	Description	Quantity
AA	Nut	4
BB	Spring Washer	4
CC	Flat Washer	4
DD	Allen Wrench	1
EE	Hexagon Wrench	1

Pre-assembly (continued)

PACKAGE CONTENTS

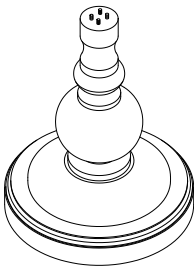

A

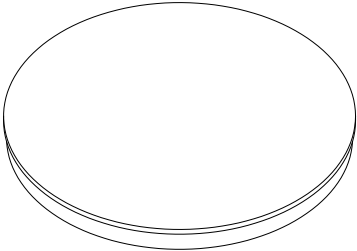

B

Part	Description	Quantity
A	Wood Post	1
B	Table Top	1

Assembly

1 Uninstall Square Board from Table Top

- Remove the square board from the rear side of Table Top (B) by uninstalling the pre-installed hardware using the Allen Wrench (DD). **Apply four times.**
- Keep square board and pre-installed hardware for step 2 and step 3.

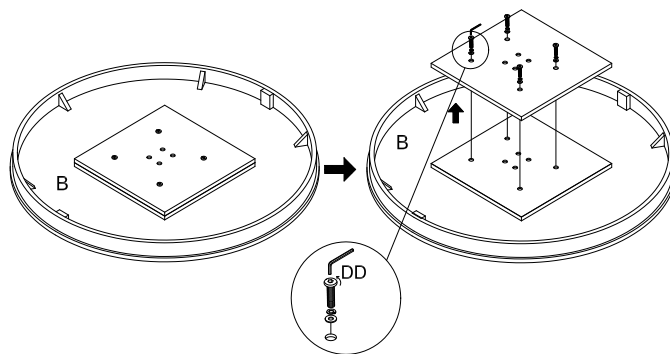

2 Remove Pre-installed Cross Block

- Uninstall the Wood Screw to take out the pre-installed cross block. **Apply four times. The cross block and wood screws are not needed for later steps.**

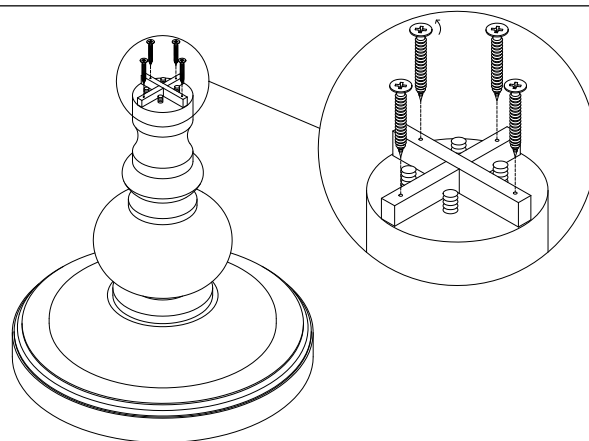

3 Assemble Square Board with Wood Post

- Place the square board from step 1 onto the Wood Post (A).
- Attach the, Flat Washer (CC), Spring Washer (BB) and Nut (AA) with the pre-installed screw on top side of Wood Post (A). Use the Hexagon Wrench (EE) to tighten and assemble the square board and Wood Post (A) together. **Apply four times.**

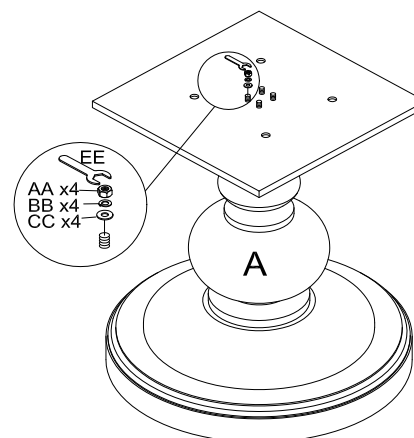

Assembly

4 Assemble Table Base with Table Top

- Align the top of the Wood Post (A) with the rear side of Table Top (B).
- Attach the pre-installed hardware from step 1. Use Allen Wrench (DD) to tighten and assemble Wood Post (A) and Table Top (B) together. **Apply four times.**

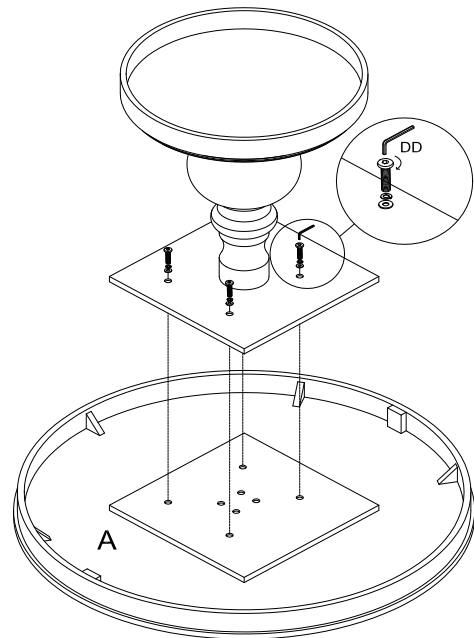

5 Adjust Height of Table

- Twist the pre-installed levelers to adjust the height of the table.

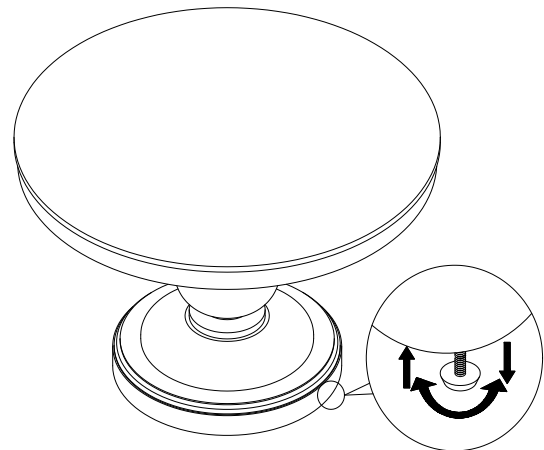

Maintenance

- In the event that your furniture is stained or otherwise damaged during use, we recommend that you call a professional to repair your furniture.
- Check bolts/screws periodically and tighten them if necessary.

Care and Cleaning

- Use a soft, clean cloth that will not scratch the surface when dusting.
- Using solvents of any kind on your furniture may damage the finish.
- Use of furniture polishes is not necessary.
- Never use water to clean your furniture, as it may cause damage to the finish.
- Liquid spills should be removed immediately. Use a soft and clean cloth to blot the spill gently. Avoid rubbing.
- Use of furniture polishes is not necessary.
- Avoid placing furniture directly under windows.

**HOME
DECORATORS
COLLECTION®**

Questions, problems, missing parts?
Before returning to the store, call Home Decorators Collection Customer Service.
8 a.m. – 7 p.m., EST, Monday – Friday, 9 a.m. – 6 p.m., EST, Saturday

1-800-998-7021

HOMEDEPOT.COM/HOMEDECORATORS

Retain this manual for future use.