

Item # 1000 000 000

Model: A203005200

HAMPTON BAY[®]

USE AND CARE GUIDE

PADEN CHAIR

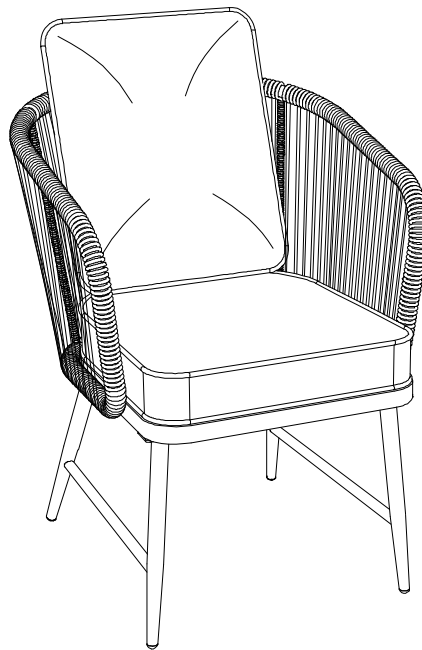

Questions, problems, missing parts? Before returning to the store,
call Hampton Bay Customer Service
8 a.m. - 7 p.m., EST, Monday-Friday, 9 a.m. - 6 p.m., EST, Saturday

1-855-HD-HAMPTON

HAMPTONBAY.COM

THANK YOU

We appreciate the trust and confidence you have placed in Hampton Bay through the purchase of this chair. We strive to continually create quality products designed to enhance your home. Visit us online to see our full line of products available for your home improvement needs. Thank you for choosing Hampton Bay!

Table of Contents

| | | | |
|---------------------------|-----------|-------------------------|---|
| Table of Contents..... | 2 | Pre-Assembly | 4 |
| Safety Information..... | 错误!未定义书签。 | Planning assembly | 4 |
| Warranty..... | 2 | Hardware Included..... | 4 |
| What is Covered | 2 | Package Contents | 4 |
| What is Not Covered | 2 | Assembly | 5 |
| | | Care and Cleaning | 6 |

Important Safety Instructions

READ ALL INSTRUCTIONS BEFORE USE

To reduce the risk of injury to persons:

- Some parts may contain sharp edges. Wear protective gloves.
- Please count the parts before assembly.
- Set up your furniture properly. Ensure that all parts are assembled properly and fully tightened as per instructions. When placing in the desired location, ensure that all legs are resting on the same surface. You may adjust the leg levelers as required to ensure that the item stands in a level position.
- Examine occasionally to ensure that there are no loose parts. If loose parts are found, they must be re-tightened fully before additional use.



DANGER: Keep children and parts away from the assembly area.



WARNING: To avoid destroying the finish, please handle the surface by using a soft cloth instead of your bare hands. Due to the nature of iron, surface oxidation (rusting) will occur if these protective coatings are scratched. We recommend immediate touch-up with rust inhibiting paint (not included).



CAUTION: Do NOT overtighten any of the bolts or nuts.

Warranty

2 YEAR WARRANTY

WHAT IS COVERED

This limited warranty is extended to the original purchaser and applies to defects in materials and workmanship of your item provided the item is maintained with care and used only for personal, residential purposes. The item is warranted to be free from defects in material or workmanship for a period of 2 years.

WHAT IS NOT COVERED

We do not reimburse for transportation of delivery costs, or compensate the individual or any outside party for assembling or disassembling the product.

Contact the Customer Service Team at 1-855-HD-HAMPTON or visit HAMPTONBAY.COM.

Production Number: 2020XXXX

Pre-Assembly

PLANNING ASSEMBLY

Before beginning assembly of this product, make sure all parts are present. Compare parts with the Hardware Included and Package Contents lists. If any part is missing or damaged, do not attempt to assemble the product. Contact customer service for replacement parts.

HARDWARE INCLUDED



NOTE: Hardware not shown to actual size.

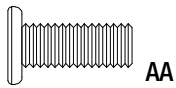

AA



BB



CC



DD

| Part | Description | Quantity |
|------|------------------|----------|
| AA | Bolt M6*12 | 12 |
| BB | Spring Washer M6 | 12 |
| CC | Flat washer M6 | 12 |
| DD | Wrench M6 | 1 |

PACKAGE CONTENTS

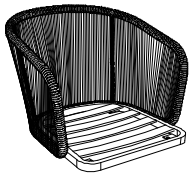

A

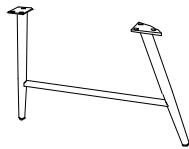

B1

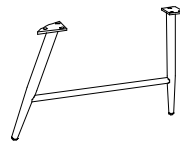

B2



C

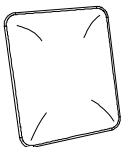

D

| Part | Description | Quantity |
|------|--------------|----------|
| A | Back | 1 |
| B1 | Leg 1 | 1 |
| B2 | Leg 2 | 1 |
| C | Cushion | 1 |
| D | Back Cushion | 1 |

Assembly

1 Attaching the Legs

- Attach the legs (B1&B2) to the back (A) using bolts (AA), spring washers (BB) and flat washers (CC). There are total 12 bolts, fully tighten the all bolts. Wrench (DD) is used in this step.



NOTE: To avoid destroying the finish, do not put the parts on the ground directly.

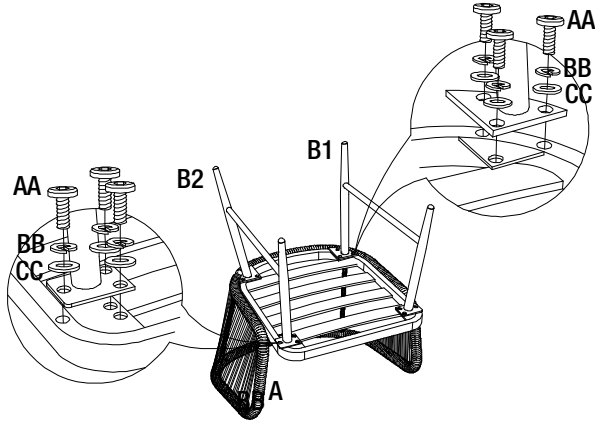

2 Placing the Cushion

- Place the Cushions (C) and Back cushions (D) on the Seat.



NOTE: To avoid destroying the finish, do not put the parts on the ground directly.

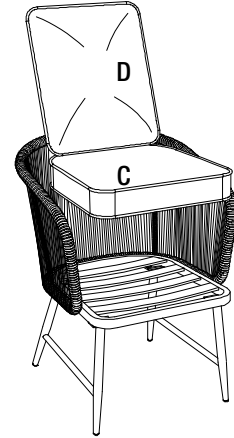

Care and Cleaning

- Before using, clean the chair completely with a soft dry towel.
- Do not put your chair in wet conditions, such as rain, where there is a risk of rust developing.
- When not in use, store in a cool, dry area.

HAMPTON BAY[®]

Questions, problems, missing parts? Before returning to the store,
call Hampton Bay Customer Service
8 a.m. - 7 p.m., EST, Monday-Friday, 9 a.m. - 6 p.m., EST, Saturday

1-855-HD-HAMPTON

HAMPTONBAY.COM

Retain this manual for future use.
