

MODEL VG08009

CONTENT

PACKING LIST / TOOLS NEEDED

PANEL DIMENSIONS

FITTINGS / TECHNICAL DATA

WALL/CORNER INSTALLATION

CARE AND TROUBLE SHOOTING

WARRANTY

PACKING LIST

DESCRIPTION	MODEL NUMBER
- PANEL HOUSING	88066
- HAND SHOWER HOSE	88004
- HAND SHOWER	88001
- FLEXIBLE HOSES 16" LONG WITH 1/2" FEMALE CONNECTION FOR HOT & COLD WATER SUPPLY	88005
- WALL MOUNTING BRACKET - 3PC	88006
- CORNER MOUNTING BRACKET - 2PC	88007F
- FIXING PLUGS - 8 PC	84000
- SCREWS - 8PC	88008
- BLUE WASHERS - 2PC	84044
- METAL WASHERS - 6PC	88092
- BLACK SCREEN - 2 PC	84001
- CORNER BRACKET INSTALLATION HDWR - 4SET	88074
- HAND SHOWER MOUNTING BRACKET - W/HDWR	84005

MISCELLANEOUS PARTS

- VALVE HOUSING	88078
- THERMOSTATIC CARTRIDGE TYPE B	88011B
- DIVERTER CARTRIDGE	88012
- VOLUME CARTRIDGE	88013
- DIVERTER HANDLE	88079
- VOLUME CONTROL HANDLE	88080
- THERMOSTATIC CONTROL HANDLE	88081
- DIVERTER / VOLUME HANDLE BUTTON	88082
- THERMOSTATIC HANDLE BUTTON	88083
- HAND SHOWER CONNECTOR	88027

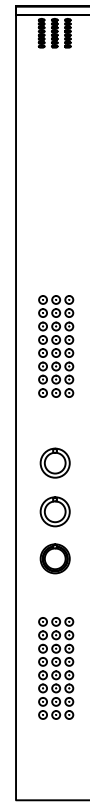

88066

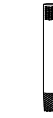

88001

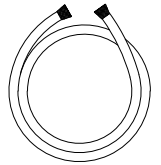

88004



84000



88005



84044

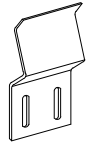

88006

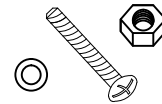

88074

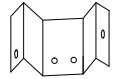

88007F

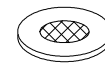

84001



84005



88008



88092

TOOLS (NOT INCLUDED)

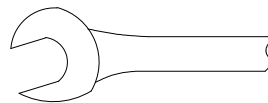

FREE FROM ACETIC ACID

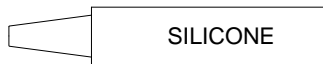

SILICONE

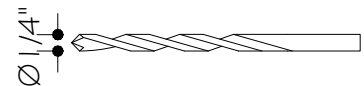
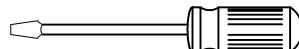
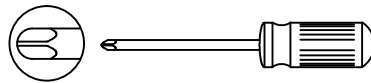

Ø 1/4"



PSI

PRESSURE GAUGE TO ASSURE PROPER PRESSURE (MAX 60 PSI)

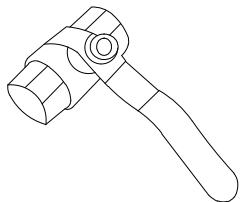

RECOMMENDED - SHUT OFF VALVES FOR HOT AND COLD

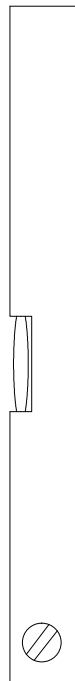

MODEL VG08009

PANEL DIMENSIONS

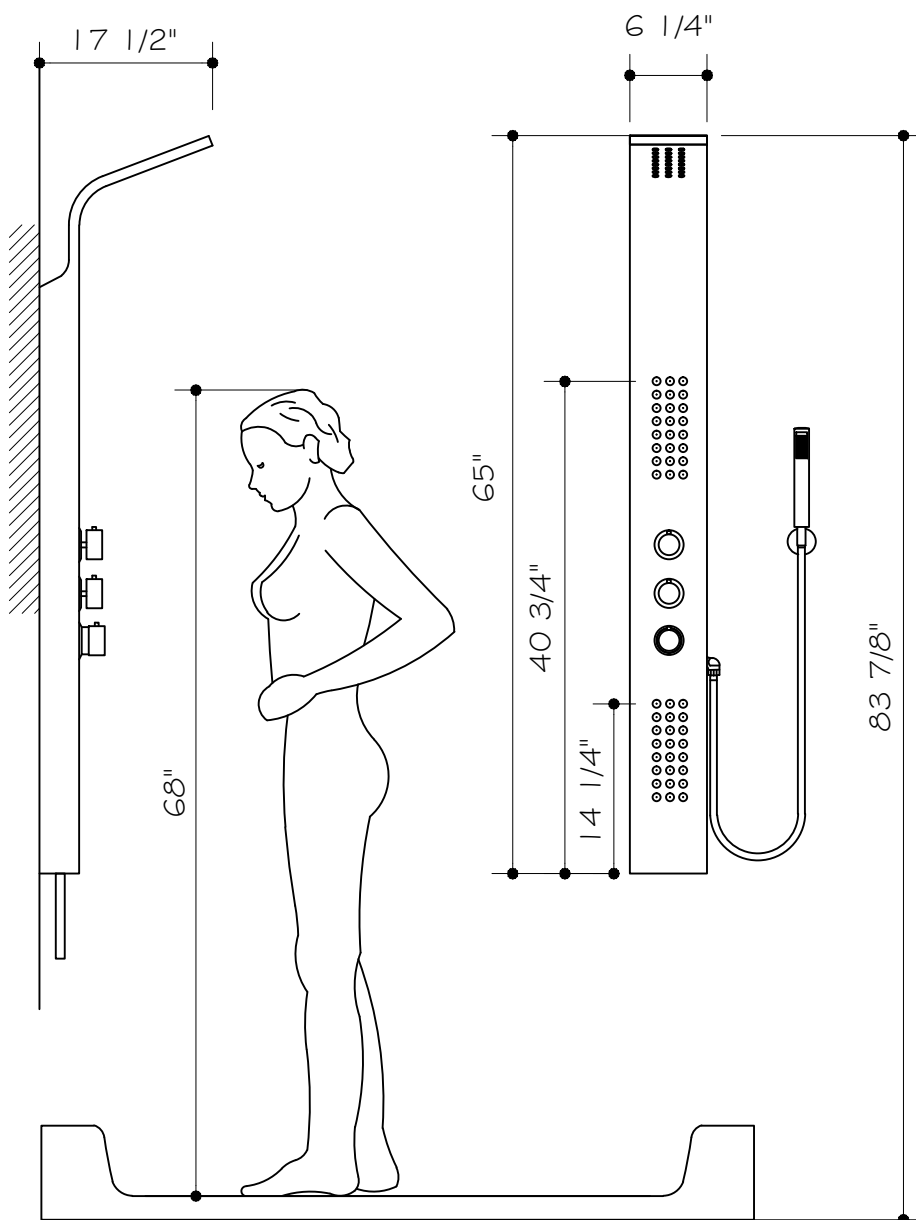

* = Dimension may vary up to 3/8". It is highly recommended to pull all dimensions off actual model for installation and measuring purposes.

MODEL VG08009

THE MEASUREMENTS IN INCHES ARE ROUNDED TO THE NEAREST 1/8"

FITTINGS/TECHNICAL DATA

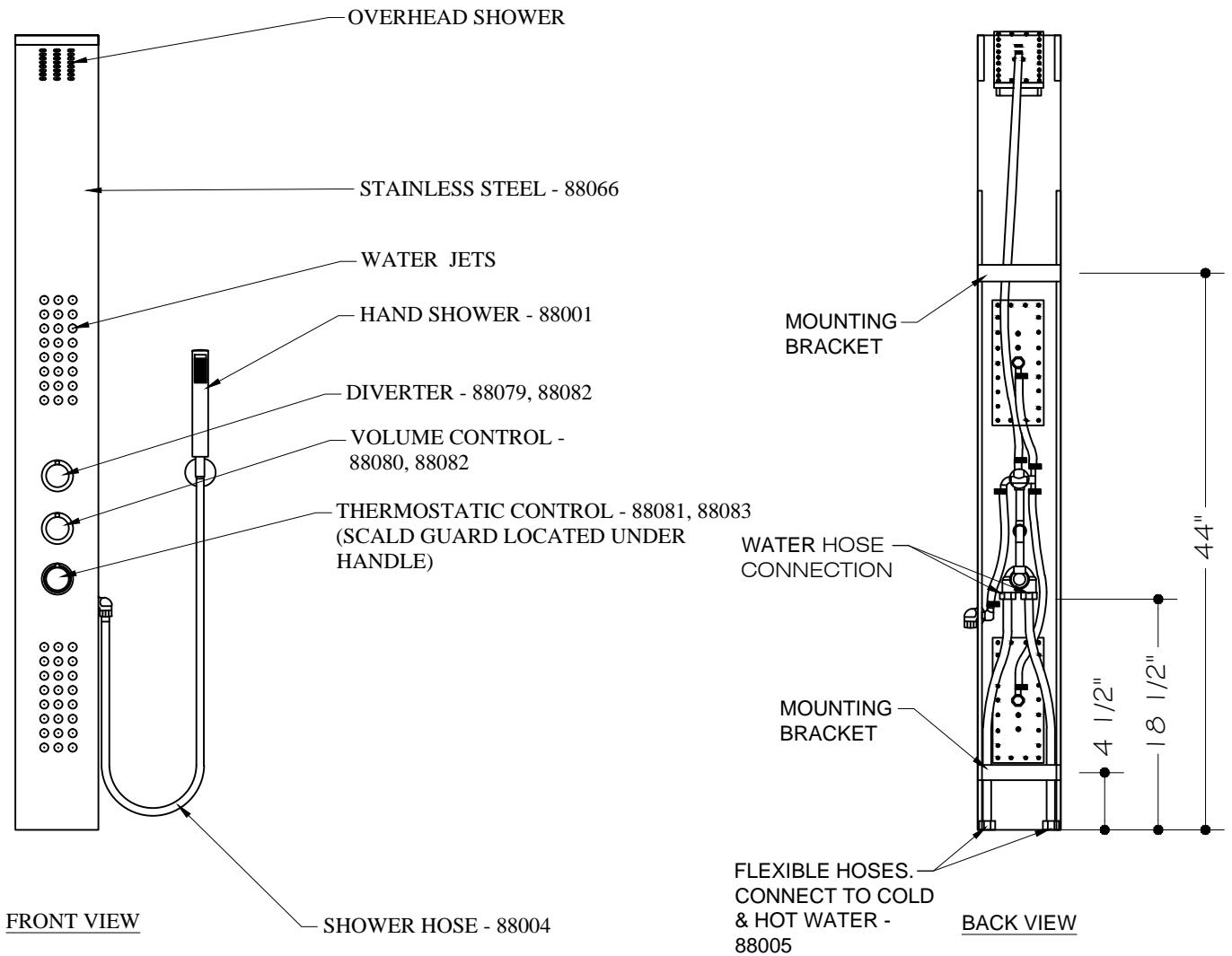

TECHNICAL DATA

MIN. FLOW PRESSURE 30 PSI
 MAX OPERATING PRESSURE 60 PSI
 HOT WATER TEMPERATURE MAX. 158°F
 SAFETY STOP 100°F
 OVERALL WATER PRESSURE IS 2.5 GALLONS
 HEAD SHOWER 2.0 GALLONS
 PER MINUTE AT 60 PSI

WALL INSTALLATION

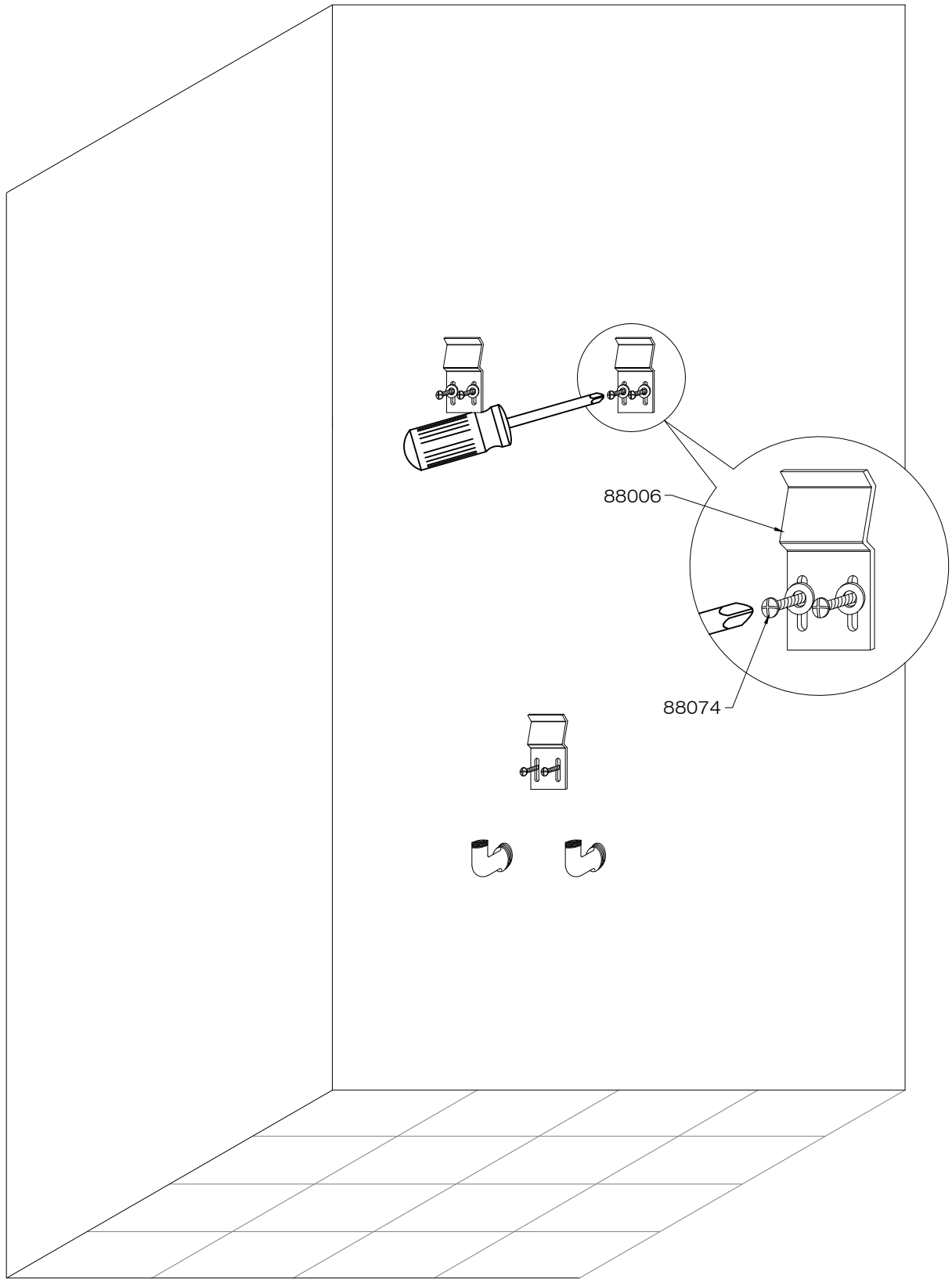

WALL INSTALLATION

Note to customer:
It may be advantageous to
bend brackets towards
person for easier installation.

 Make sure not to over bend
and cause damage to the
brackets.

Save time and frustration: if
turning the thermostatic control
handle gives both hot and cold
water, but the water does not
mix, the hoses have been
connected to the incorrect
supplies. Please disconnect the
hoses, reattach them to the
correct supplies and test the
unit before calling the Vigo
Technical Service center.

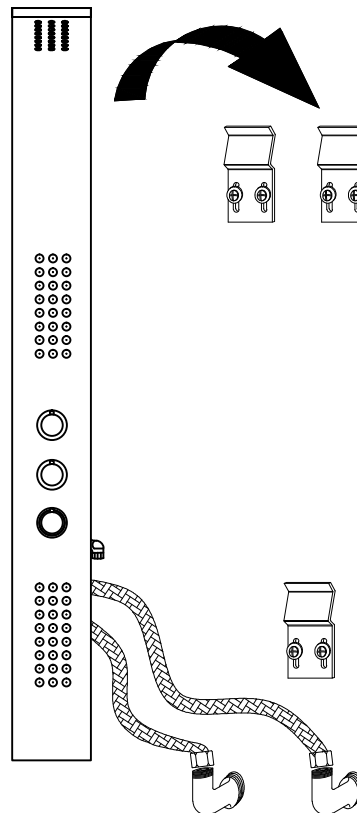

CORNER INSTALLATION

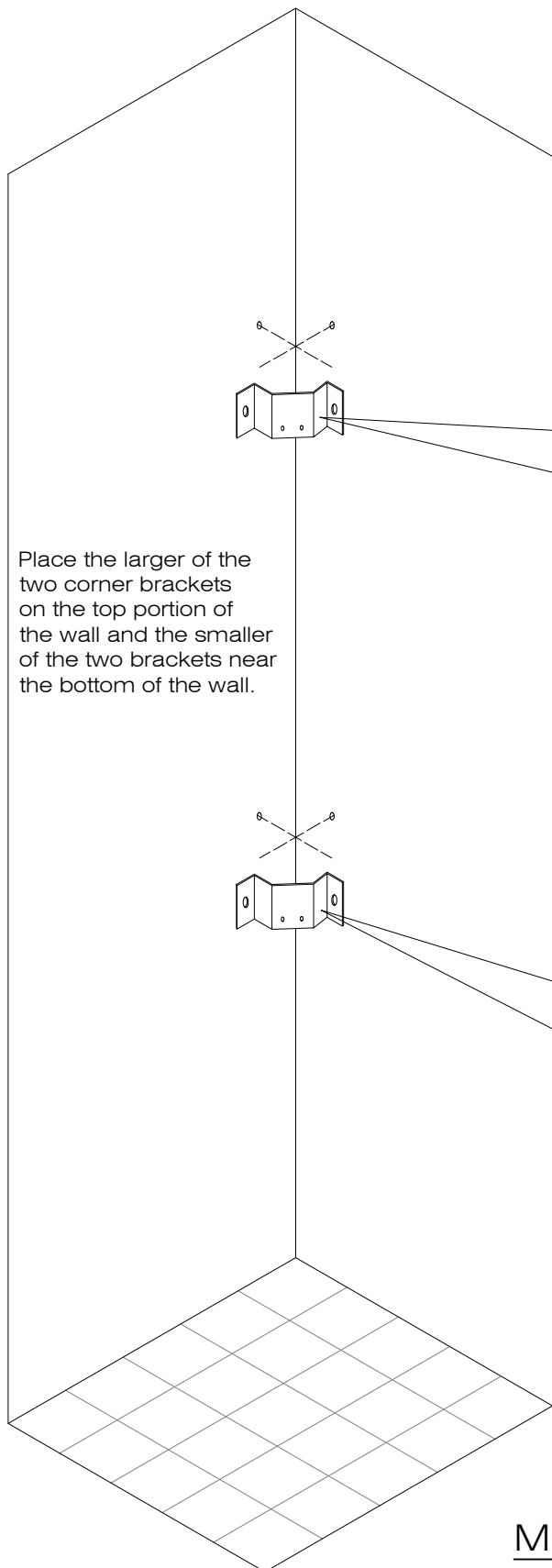

Place the larger of the two corner brackets on the top portion of the wall and the smaller of the two brackets near the bottom of the wall.

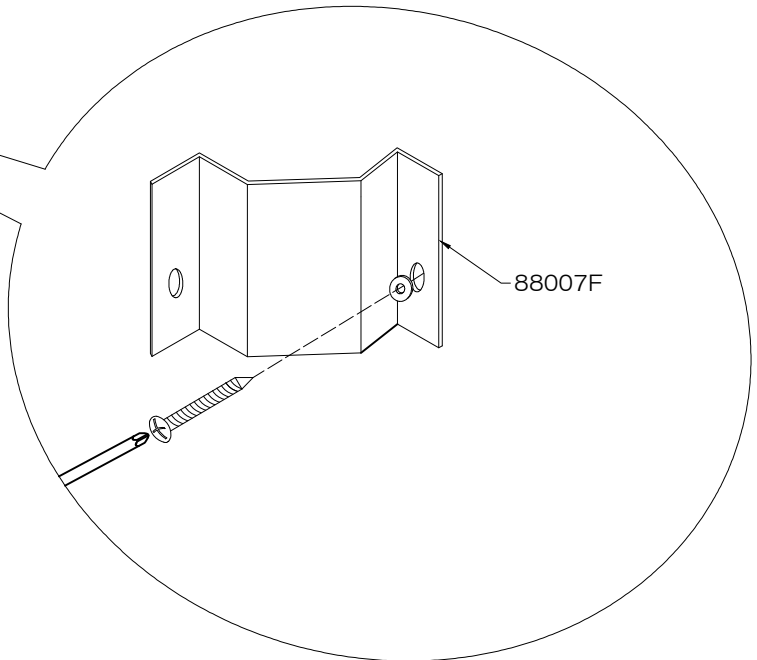
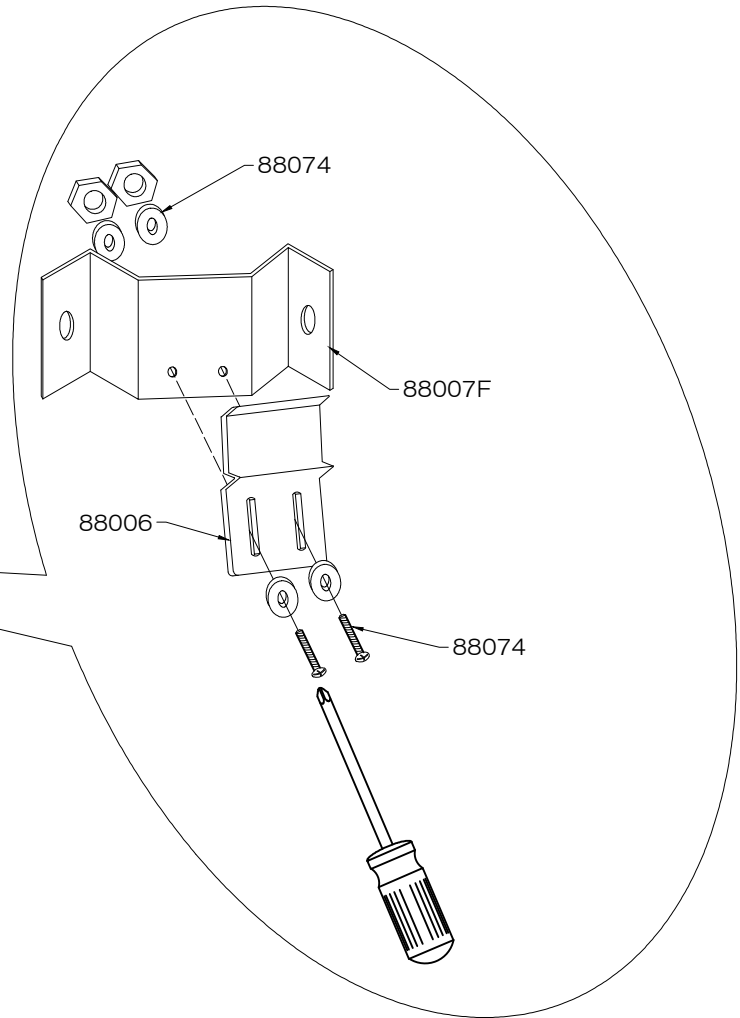

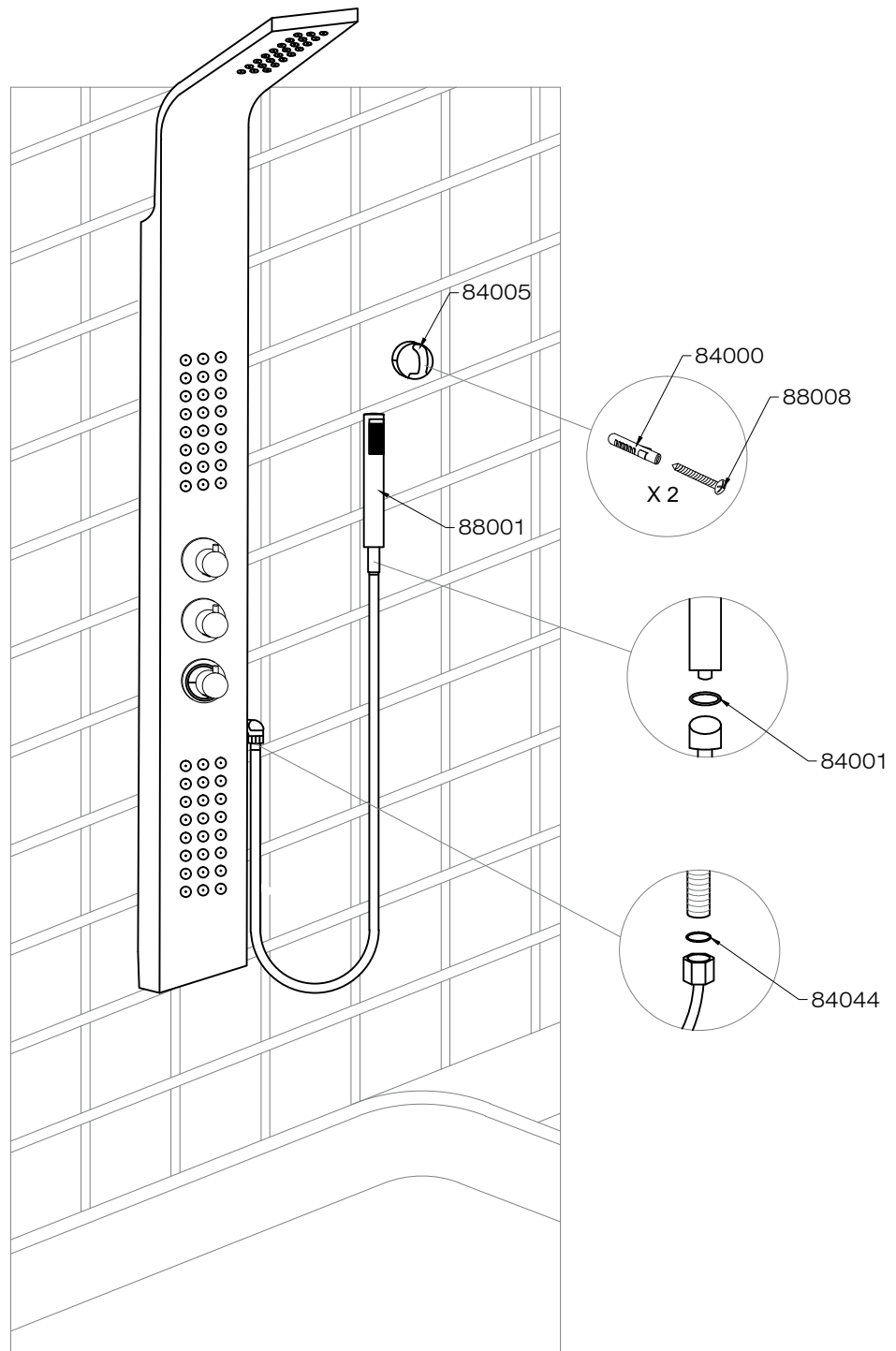

Cleaning Recommendation for Vigo Products

Modern sanitary tapware, kitchen mixers and showers consist of very different materials to comply with the needs of the market with regard to design and functionality.

To avoid damage and reclamations, it is necessary to consider certain criteria when cleaning.

Cleaning Material for Mixers and Showers

Acids are necessary ingredients of cleaning materials for removing lime, however, please pay attention to the following points when cleaning mixers and showers:

- Only use cleaning materials which are explicitly provided for this type of application.
- Never use cleaning materials which contain hydrochloric, formic or acetic acid, as they cause considerable damage.
- Phosphoric acid is also restricted as it can cause damage to the finish.
- Never mix any cleaning material with another.
- Never use cleaning materials or appliances that have an abrasive effect, such powdered and industrial cleansers, scouring pads or micro fiber cloths.

Cleaning Instructions for Mixers and Showers

Please follow the instructions on your cleaning materials. In addition, pay attention to the following points:

- Clean the mixers and showers as needed and when required.
- The cleaning dosage and time the cleaner needs to take effect should be adjusted according to the product and the cleaner should not be left longer than necessary.
- Regular cleaning can prevent calcification.
- When using spray cleaner, spray first onto a cloth or sponge-never directly spray onto the sanitary tapware as drops could enter openings and gaps and cause damage.
- After cleaning, rinse thoroughly with clean water to remove any cleaner residue.

Important

Residues of liquid soaps, shampoos and shower foams can also cause damage, so rinse with clean water after using. If the surface is already damaged, the effect of cleaning materials will cause further damage.

DAMAGE CAUSED BY IMPROPER TREATMENT WILL NOT BE COVERED BY OUR GUARANTEE AND/OR WARRANTY

Trouble Shooting

Issue	Cause	Remedy
water level is too low	debris in flexible hose connection	flush the line
hand shower delivering insufficient water	build up of mildew or soap scum	soak or replace hand shower
temperature regulation not possible (only hot or cold water at time of installation)***	thermostatic cartridge is defective	exchange thermostatic cartridge
	PSI or GPM improper	install pressure regulator
temperature regulation not possible (only hot or cold water)	thermostatic cartridge is defective or supply hose(s) faulty	exchange thermostatic cartridge resecure or replace supply hose(s)

*** Vigo is not responsible for pressure related issues stemming from the home's water supply. The customer should read, understand and/or ask a certified plumber prior to installation. If these steps are not taken the product may not work at optimum efficiency.

TOLL FREE: (866) 591 - 7792

E-Mail:
techmail@vigoindustries.com

www.vigoindustries.com



VIGO INDUSTRIES, LLC ("VIGO")
SHOWER PANEL LIMITED LIFETIME WARRANTY

EFFECTIVE JANUARY 1, 2010

VIGO offers the following limited warranty on each of its Shower Panel products* (the "Product") and the components thereof. This warranty extends only to the original owner or end-user for personal household use. For commercial uses, additional limitations apply.

VIGO warrants the structural components of the Product to be free from defects in workmanship and materials under normal use and service for the period commencing from the initial date of purchase by the owner or end-user, contractor, or builder, from VIGO or an authorized VIGO dealer, through the lifetime of the original owner or end-user.

VIGO warrants the mechanical components of the Product to be free from defects in workmanship and materials under normal use and service for a period of two (2) years from the initial date of purchase by the owner or end-user, contractor, or builder, from VIGO or an authorized VIGO dealer.

Subject to the Warranty Service provision below, any product reported to the authorized dealer or to VIGO as being defective within the warranty period will be repaired or replaced (with a product of equal value) at the option of VIGO. This warranty extends to the original owner or end-user and is not transferable to a subsequent owner.

Neither the distributor, authorized VIGO dealer, nor any other person has been authorized to make any affirmation, representation, or warranty other than those contained in this warranty. Any affirmation, representation, or warranty other than those contained in this warranty shall not be enforceable against VIGO or any other person.

VIGO reserves the right to modify this warranty at any time, it being understood that such modifications will not alter the warranty conditions applicable at the time of sale of the products in question.

Limitations

This warranty shall not apply to instances of incorrect operating procedures, breakages, or damages caused by fault through improper installation, carelessness, abuse, misuse, misapplication, improper maintenance, or alteration of the Product, as well as chemical or natural corrosion, accident, fire, flood, an act of God, or any other casualty. Avoid abrasive cleaners, steel wools, and harsh chemicals as these will scratch, damage, and / or dull the product and / or finish and void this warranty. The owner/end-user of the Product covered by the present warranty is entirely responsible for its proper installation and any applicable plumbing or electrical wiring. VIGO neither installs nor supervises the installation nor hires a contractor for this purpose; consequently, VIGO cannot be held responsible for any default, breakage, or damages caused thereby or resulting thereof, either directly or indirectly.

The owner/end-user must provide access to the components of the Product as described in the installation guide so that VIGO can execute the warranty specified herein. If such access is not available, all expenses to provide said access will be the responsibility of the owner/end-user.

This warranty does not apply to Products that have not been installed or operated in accordance with instructions supplied by VIGO and all applicable rules, regulations, and legislation pertaining to such installations.

This warranty does not apply unless the VIGO Product is installed by fully insured licensed professionals. VIGO strongly recommends that such licensed professionals have experience in the installation of bathroom and kitchen products. Installation of certain products, including, without limitation, glass products (i.e., shower doors and glass sinks) by an inexperienced person may result in glass breakage and, consequently, cause personal injury or death.

VIGO is not liable for personal injuries or deaths to any persons or for any direct, special, incidental, or consequential damage, loss of time, loss of profits, inconvenience, incidental expenses, labor or material charges, or any other costs resulting from the use of the product or equipment or pertaining to the application of the present warranty, or resulting from the removal or replacement of any product or element or part covered by this warranty.

EXCEPT AS OTHERWISE PROVIDED ABOVE, VIGO MAKES NO WARRANTIES, EXPRESSED OR IMPLIED, INCLUDING WARRANTIES OF MERCHANTABILITY AND FITNESS FOR A PARTICULAR PURPOSE OR COMPLIANCE WITH ANY CODE.

In any case, VIGO cannot be held liable for any amount over and above the purchase price paid for the Product by the owner/end-user, contractor, or builder.

Commercial Limitations

In addition to the above conditions and limitations, the warranty period for products installed for commercial applications or used in commercial ventures is one (1) year from the initial date of purchase by the owner/end-user, contractor, or builder from an authorized dealer. VIGO is not responsible for loss of use or profit under any circumstances. If the product is used as a display, the warranty period begins when the product is placed on display. This warranty gives the owner/end-user specific legal rights. The owner/end-user may also have other rights which can vary from one state or province to another.

Warranty Service

In order to obtain service provided under this warranty during regular business hours, contact the dealer or distributor who sold the unit, or contact VIGO directly. VIGO will provide the warranty service described above when the following conditions have been met: the failure is of the nature or type covered by the warranty; the user has informed an authorized VIGO Agent or VIGO's warranty service department representative of the nature of the problem during the warranty period; conclusive evidence (e.g., proof of purchase or installation) is provided to the foregoing by the user proving that the failure occurred or was discovered within the warranty period; an authorized independent service person or company representative has been permitted to inspect the product during regular business hours within a reasonable time after the problem was reported by the user. VIGO's warranty obligation shall be discharged upon tender of replacement or repair. The customer's refusal to accept the tender terminates VIGO's warranty obligations.

*Certain models are pending approval.

Certification may be ended by VIGO or certification agencies without notice.