



Specifications

ABF 80 G16 Series

Quiet Bathroom Ventilation Fan

Description: Low RPM, low noise, ceiling mount bathroom fan engineered for continuous operation • Suitable for new construction, or remodeling • HVI certified • ENERGY STAR qualified • ETL/cETL listed for use in insulated ceilings (Type I.C.).

Motor/Blower: Permanently lubricated high performance AC motor engineered for continuous operation; power rating 120v/60Hz; motor equipped with thermal shut off.

Housing: Galvanized steel body; duct connector adapts to 4", 5" or 6", built-in back draft dampener; quick easy-mount anti-vibration brackets included; designed for installation in ceilings with minimum of 8" clearance.

Grille: Low maintenance, wipe clean; attaches to housing with torsion springs.

Finishes: White (W); Satin Nickel (S); Oil Rubbed Bronze (OR).

Ventilating Area: For bathrooms up to 80 sq ft.

Installation: Must be installed by licensed professional. Complete installation instructions included.

Warranty: 6 Years

Architect's Specifications: Ventilation fan will be ceiling mount, ENERGY STAR qualified, with no less than 80 CFM and no more than 0.4 Sones as certified by HVI at 0.1 static pressure in inches water gauge. Power consumption shall be no greater than 18.0 watts and ENERGY STAR rated with an efficiency rating of no less than 4.47 CFM/watt. The motor will be permanently lubricated, engineered for continuous operation. Duct diameter will be 4", 5", or 6" round. Fan shall be listed for tub/shower enclosure when used with GFCI branch circuit wiring and shall be ETL/cETL listed for use in insulated ceiling (Type I.C.). Fan shall be ASHRAE 62.2, LEED, California Title 24, and Washington VIAQ compliant.

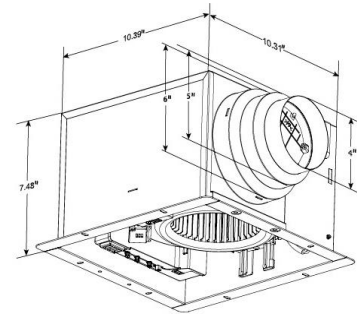

ETL/cETL Listed for installation over tub/shower enclosure when used with GFCI circuit wiring

Images On the Way

G16 (OR) • G16 (SN) • G16 (W) Grille

Model: ABF 80 G16 Series	4" Duct	
Static Pressure (inches w.g.)	0.1	0.25
Air Volume (CFM)	80	50
Noise (sones)	0.4	0.6
Power Consumption (Watts)	18.0	16.6
Energy Efficiency (CFM/Watts)	4.47	3.35
Speed (RPM)	849	N/A
ENERGY STAR rated	Yes	
Grille Dimensions	13" x 13"	



Model	Qty	Comments	Project
			Location
			Architect
			Engineer
			Contractor
			Submitted by
			Date