



**OLYMPIA FAUCETS, INC.**  
 3325 S. Garfield Ave.  
 Commerce, CA 90040  
 (888) 772-7701  
 www.olympiafaucets.com

# INSTALLATION

**Tools:**



Adjustable Wrench Phillips screwdriver Plumbers Putty Teflon Tape Rags

**Model Number: K-5010**

**Warnings and Notes:**

Check with local plumbing code requirements before installation.  
 This product should be installed by a local listed plumber.  
**Do not use plumbers putty on threads.**



**Installation Steps:**

Single Handle Pull-Down Pre-Rinse Kitchen Faucet

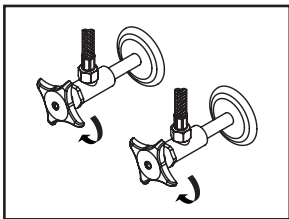

(1) Shut off water supplies. Remove old faucet. Clean mounting surface in preparation for new faucet.

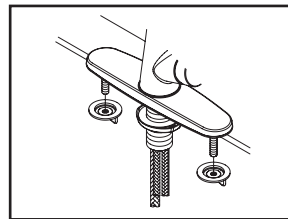

(3b) Thread and tighten both mounting nuts to mounting bolts from underneath of the sink to secure deck plate.

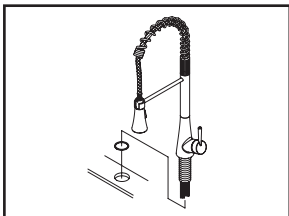

(2a) **For 1-Hole Installation:-** Ensure there is a washer under the faucet. Place the faucet in position on the sink.

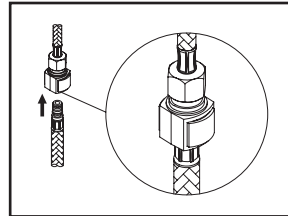

(4) Insert spray head hose into end of quick connect adapter on the outlet hose, push until a "click" is heard. Pull down to test engagement.

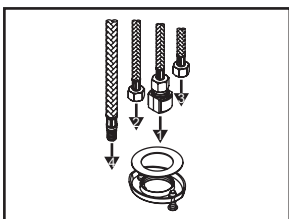

(2b) Please follow the order as drawing shows to insert flex hose through center hole of the locknut from underneath of the sink.

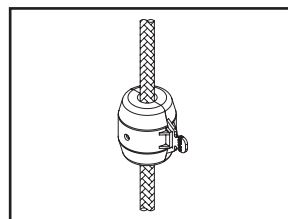

(5) Install weight on spray head hose. Adjust weight's position so the spray head can be retracted properly.

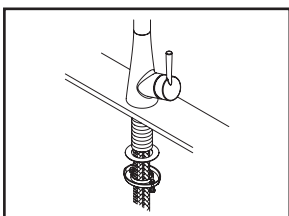

(2c) From underneath of the sink hand-tighten locknut to the faucet. Position faucet to desired location from top. Tighten screws on locknut with the help of Phillips head screwdriver to secure faucet.

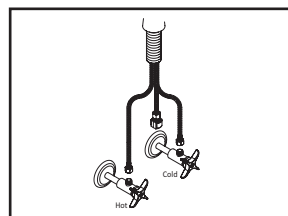

(6) Connect hot and cold inlet supply hoses to supply stops. For 1/2" connection; use 3/8" male to 1/2" female adapter for installation. Adapters are optional and not provided with the faucet.

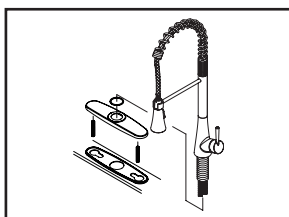

(3a) **For 3-Hole Installation:-** Place faucet on the deck plate, hand-tighten locknut to the faucet, tighten screws on locknut with the help of Phillips head screwdriver to secure the faucet. Thread mounting bolts to deck plate, apply plumbers putty under the base gasket and lead inlet & outlet flex hoses through center mounting hole to place faucet with base gasket in position on the sink.

## Exploded Drawing :

\* Note: Please specify finish/color when ordering.

	ITEM #	DESCRIPTION
A	OP-420067*	1.8 GPM Spray Head
B	X-4200198*	Spray Hose
C	OP-420069*	Spring
D	OP-420056	Spout Repair Kit
E	OP-390003	Ceramic Disc Cartridge
F	OP-420057	Retainer Nut
G	OP-420058*	Cap
H	OP-120004*	Lever Handle
I	OP-420059	Washer
J	X-4200199	Quick Connect
K	OP-520015	Locknut with Screws
L	OP-420070	Weight
M	OP-420045*	Deck Plate & Base Gasket
N	OP-520003	Mounting Bolts & Nuts
1	OP-420061	Allen Screw

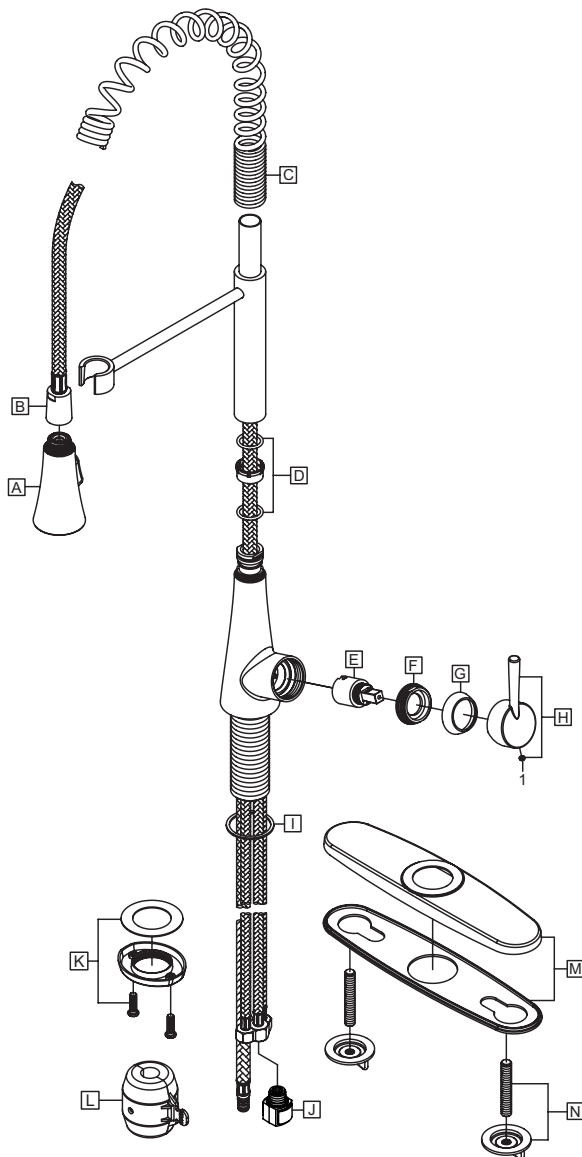

**OLYMPIA**

For more care information or trouble shooting inquiries  
about your Olympia product, Please call:  
**OLYMPIA FAUCETS, INC.** (888) 772-7701  
Monday-Friday 8 AM to 8 PM EST (5 AM to 5 PM PST)  
[www.olympiafaucets.com](http://www.olympiafaucets.com)