



165 474



Glendale 52 in Ceiling Fan Owner's Manual

Glendale
Ventilador de Techo de 1,32 m
Manual del Propietario





Congratulations on your purchase of a Hampton Bay ceiling fan. Your new fan will be a beautiful addition to your home, and will keep you comfortable throughout the year.

The Hampton Bay Fan Company offers a wide variety of ceiling fans. We offer combinations of wood and brass finishes, solid designer colors, and our unique glass and crystal designs.

A large selection of light fixtures and light kits is also available. Ask your dealer about other accessories that will allow you to further customize your fan.

We're certain that your Hampton Bay fan will provide you with many years of comfort, energy savings and satisfaction. To ensure your personal safety and to maximize the performance of your fan, please read this manual thoroughly.

Glendale by Hampton Bay®

52” Glendale Ceiling Fan by Hampton Bay

Thank you for purchasing our ceiling fan. This product has been manufactured with the highest standards of safety and quality.

Date Purchased _____

Store Purchased _____

UL Model No. _____ 165-474

Serial No. _____

Vendor No. _____ 11289

UPC _____ 792145356707

Table of Contents

Safety Rules	1
Unpacking Your Fan	2
Installing Your Fan	3
Installing the Light Kit.	11
Operating Your Fan	12
Care of Your Fan	13
Troubleshooting	13
Specifications	14
Warranty Information	15

Safety Rules – Read and Save These Instructions

1. To reduce the risk of electric shock, insure electricity has been turned off at the circuit breaker or fuse box before beginning.
2. All wiring must be in accordance with the National Electrical Code “ANSI/NFPA 70-1999” and local electrical codes. Electrical installation should be performed by a qualified licensed electrician.
3. **WARNING:** To reduce the risk of electrical shock or fire, do not use this fan with any solid-state fan speed control device. It will permanently damage the electronic circuitry.
4. **CAUTION:** To reduce the risk of personal injury, use only the screws provided with the outlet box.
5. The outlet box and support structure must be securely mounted and capable of reliably supporting a minimum of 35 pounds, Use only UL Listed outlet boxes marked “FOR FAN SUPPORT.”
6. The fan must be mounted with a minimum of 7 feet clearance from the trailing edge of the blades to the floor.
7. Avoid placing objects in path of the blades.
8. To avoid personal injury or damage to the fan and other items, be cautious when working around or cleaning the fan.
9. Do not use water or detergents when cleaning the fan or fan blades. A dry dust cloth or lightly dampened cloth will be suitable for most cleaning.
10. After making electrical connections, spliced conductors should be turned upward and pushed carefully up into outlet box. The wires should be spread apart with the grounded conductor and the equipment-grounding conductor on one side of the outlet box and ungrounded conductor on the other side of the outlet box.
11. All set screws must be checked and retightened where necessary before installation.

WARNING

TO REDUCE THE RISK OF PERSONAL INJURY, DO NOT BEND THE BLADE ARMS (ALSO REFERRED TO AS FLANGES), WHEN INSTALLING THE BRACKETS, BALANCING THE BLADES OR CLEANING THE FAN. DO NOT INSERT FOREIGN OBJECTS IN – BETWEEN ROTATING FAN BLADES.

WARNING

TO REDUCE THE RISK OF FIRE, ELECTRIC SHOCK OR PERSONAL INJURY, MOUNT FAN TO OUTLET BOX MARKED ACCEPTABLE FOR FAN SUPPORT WITH THE SCREWS PROVIDED WITH THE OUTLET BOX.

Unpacking Your Fan

Unpack your fan and check the contents. You should have the following items:

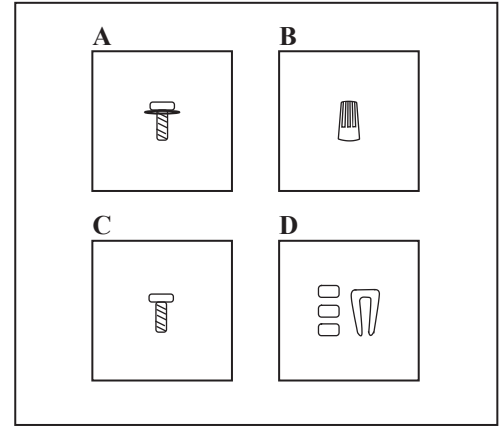
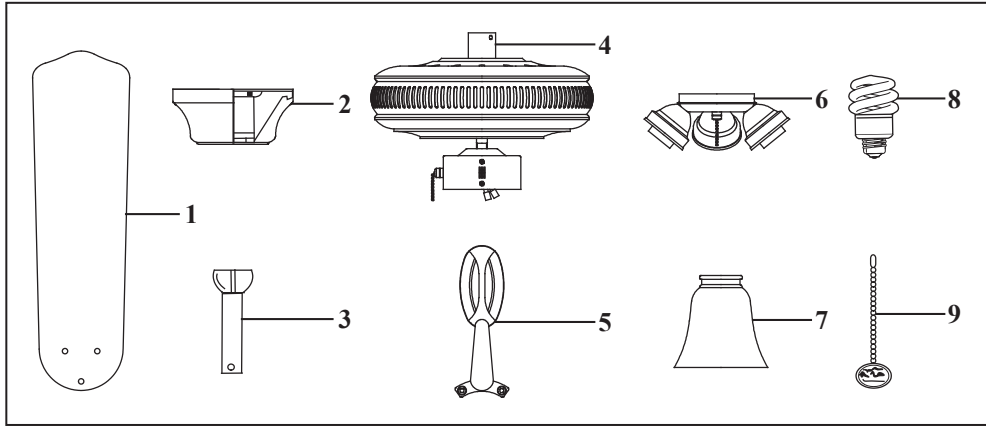

1. Set of blades (5)
2. Canopy assembly
3. Ball/downrod assembly
4. Fan motor assembly
5. Set of blade arms (5)
6. Light kit
7. Glass shades (3)
8. 13 Watt compact fluorescent bulbs (3)
9. Pull chain and fobs (2)

- A. Blade Attachment Hardware
(16 Screws with Fiber Washers)
- B. Electrical Hardware
(3 Plastic Wire Nuts)
- C. Light Kit Hardware
(1 Screw)
- D. Balance Kit

WARNING
DO NOT INSTALL OR USE FAN IF ANY
PART IS DAMAGED OR MISSING.
CALL TOLL FREE 1-877-902-5588.

Installing Your Fan

Tools Required

Phillips screwdriver, straight slot screwdriver, step ladder and wire cutters.

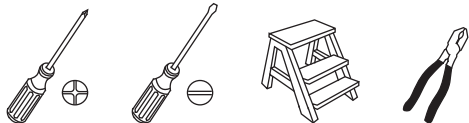

Mounting Options

If there isn't an existing UL listed mounting box, then read the following instructions. Disconnect the power by removing fuses or turning off circuit breakers.

Secure the outlet box directly to the building structure. Use appropriate fasteners and building materials. The outlet box and its support must be able to fully support the moving weight of the fan (at least 35 lbs). Do not use plastic outlet boxes.

WARNING

TO REDUCE THE RISK OF FIRE, ELECTRIC SHOCK OR PERSONAL INJURY, MOUNT FAN ONLY TO AN OULET BOX MARKED ACCEPTABLE FOR FAN SUPPORT AND USE THE MOUNTING SCREWS PROVIDED WITH THE OULET BOX. OULET BOX COMMONLY USED FOR THE SUPPORT OF LIGHTING FIXTURE MAY NOT BE ACCEPTABLE FOR FAN SUPPORT AND MAY NEED TO BE REPLACED. CONSULT A QUALIFIED ELECTRICIAN IF IN DOUBT.

Figures 1~3 are examples of different ways to mount the outlet box.

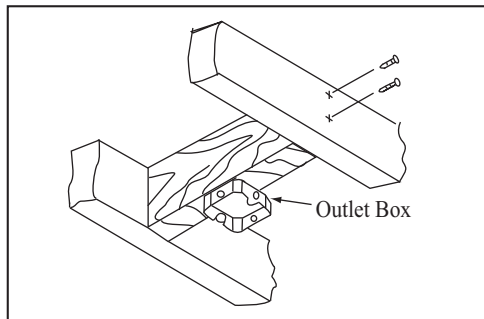

Figure 1

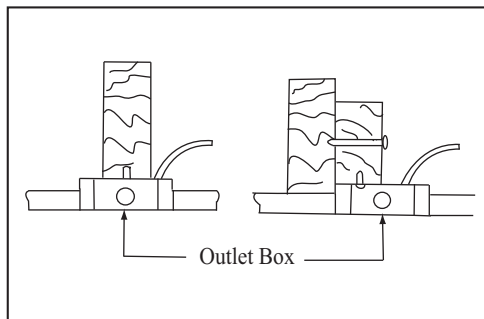

Figure 2

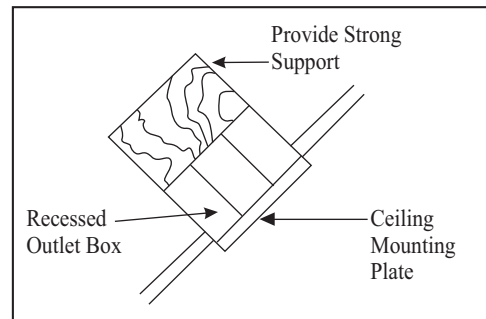

Figure 3

Note: You may need a longer downrod to maintain proper blade clearance when installing on a steep, sloped ceiling. The maximum angle allowable is 18°. If the canopy touches downrod, remove the decorative canopy bottom cover and turn the canopy 180° before attaching the canopy to the mounting plate.

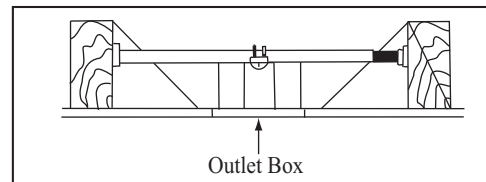

Figure 4

To hang your fan where there is an existing fixture but no ceiling joist, you may need an installation hanger bar as shown in Figure 4 (available at any Home Depot retailer).

Hanging the Fan

REMEMBER to turn off the power. Follow the steps below to hang your fan properly.

NOTE: This ceiling fan is supplied with two types of hanging assemblies; the standard ceiling installation using the downrod with ball and socket mounting, and the "close-to-ceiling" mounting. The "close-to-ceiling" mounting is recommended in rooms with less than 8-foot ceilings or in areas where additional space is desired from the floor to the fan blades.

When using the standard downrod installation, the distance from the ceiling to the bottom of the fan blades will be approximately 12 inches. The "close-to-ceiling" installation reduces the distance from the ceiling to the bottom of the fan blades to approximately 9 inches.

Once you have decided which ceiling installation you will use, proceed with the following instructions. Where necessary, each section of the instructions will note the different procedures to follow for the two types of installation.

Option 1: Standard Ceiling Mounting

1. Loosening the four screws on the top of the canopy. (Figure. 5)

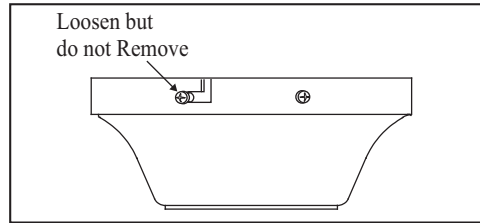

Figure 5

2. Remove the mounting bracket from the canopy by remove the two non-slotted screws and loosen the slotted screws (Figure 6).

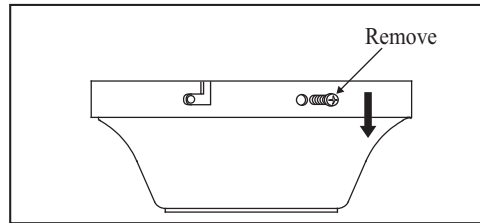

Figure 6

3. Route the wires through the canopy and then through the ball/downrod assembly (Figure. 7).
4. Loosen, but do not remove the 2 set screws on the collar on top of the motor housing.

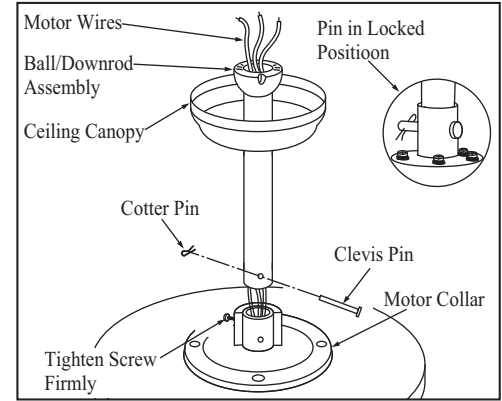

Figure 7

5. Align the holes at the bottom of the downrod with the holes in the coupling on top of the motor housing (Figure 7). Carefully insert the clevis pin through the holes in the collar and downrod. Be careful not to jam the clevis pin against the wiring inside the downrod. Insert the cotter pin through the hole near the end of the clevis pin until it snaps into its locked position, as noted in the circle inset of Fig. 7.
6. Tighten two set screws on top of the fan motor firmly. (Figure 7)

WARNING

FAILURE TO PROPERLY INSTALL COTTER PIN AS NOTED IN STEP 5 COULD RESULT IN FAN LOOSENING AND POSSIBLY FALLING.

NOTE: If a longer downrod is needed, take out the screw located in the hanger ball, lower the hanger ball and remove the pin, remove all 3 pieces from the downrod and assemble them onto the new longer downrod before proceeding step 3. (The longer downrod is available at any Home Depot store)

Option 2: Close-to-Ceiling Mounting

1. Remove the mounting bracket from the canopy by loosening the four screws on the top of the canopy. Remove the two non-slotted screws and loosen the slotted screws (Figure 5 and 6).
2. Remove the decorative canopy bottom cover from the canopy by turning the canopy bottom cover counterclockwise (Figure 8).

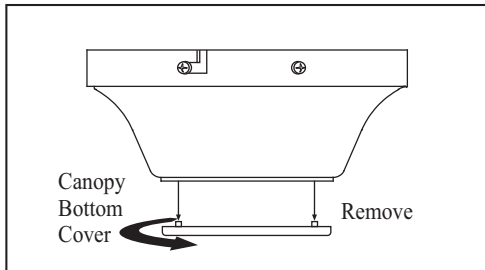

Figure 8

3. Remove three of the six screws and lock washers (every other one) from the collar of top motor (Figure 9).
4. Route the wires exiting the top of the fan motor through the canopy, then proceed to place the ceiling canopy over the collar at the top of the motor. (Figure 10)
5. Align the mounting holes with the holes in the motor and fasten using the screws and lock washers removed in step 3 (Fig. 10).
6. Tighten the mounting screws security.

WARNING

FAILURE TO COMPLETELY TIGHTEN THE THREE SCREWS IN STEP 5 COULD RESULT IN FAN LOOSENING AND POSSIBLY FALLING.

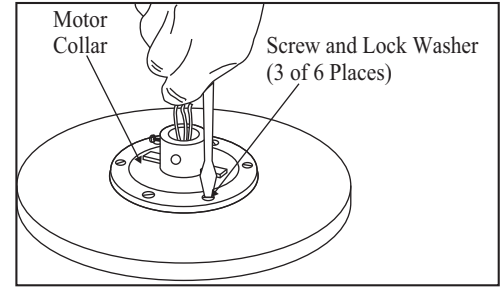

Figure 9

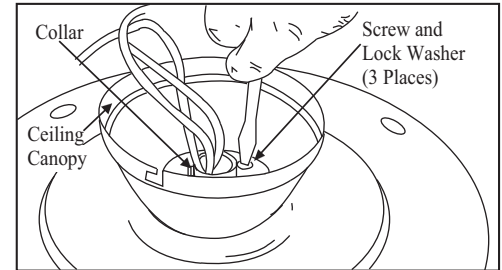

Figure 10

Installing Fan to the Electrical Box

WARNING

TO REDUCE THE RISK OF FIRE, ELECTRIC SHOCK OR OTHER PERSONAL INJURY, MOUNT FAN ONLY TO AN OUTLET BOX OR SUPPORTING SYSTEM MARKED ACCEPTABLE FOR FAN SUPPORT AND USE THE MOUNTING SCREWS PROVIDED WITH THE OUTLET BOX.

1. Pass the 120-volt supply wires through the center hole in the ceiling mounting bracket as shown in Figure 11.
2. Install the ceiling mounting bracket on the outlet box with the screws and washers provided with your outlet box (Figure 11). When using “close-to-ceiling” mounting, it is important that the mounting bracket be level. If necessary, use leveling washers (not included) between the mounting bracket and the outlet box. Note that the flat side of the mounting bracket is toward the outlet box. (Figure 11)
3. Security tighten the two mounting screws.

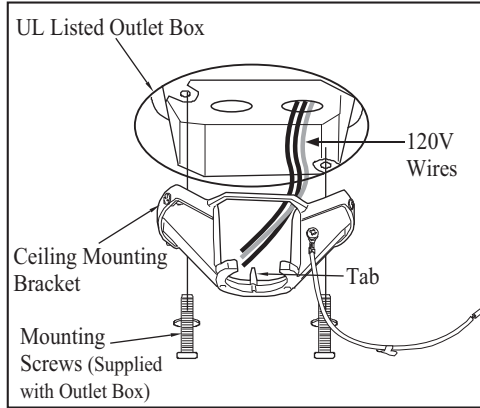

Figure 11

4. Carefully lift the fan assembly up to the ceiling mounting bracket and hang the fan on the tab provided by utilizing one of the holes at the outer rim of the ceiling canopy (Figure 12). If use standard mounting, seat the hanger ball in the mounting bracket socket. Make sure the tab on the mounting bracket socket is properly seated in the groove in the hanger ball (Figure 12).

WARNING

WHEN USING THE STANDARD BALL/ DOWN-ROD MOUNTING, THE TAB IN THE RING MUST REST IN THE GROOVE OF THE HANGER BALL. FAILURE TO PROPERLY SEAT THE TAB IN THE GROOVE COULD CAUSE DAMAGE TO WIRING.

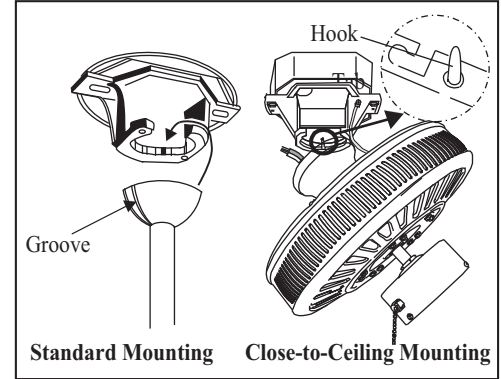

Figure 12

WARNING

THE TAB AS SHOWN IN FIGURE 12 IS ONLY TO BALANCE THE FAN WHILE ATTACHING WIRING. FAILURE TO HANG AS SHOWN IN FIGURE 12 MAY RESULT IN TAB BREAKING CAUSING THE FAN TO FALL. TAB MUST PASS FROM INSIDE TO OUTSIDE OF CANOPY.

Making the Electrical Connections

REMEMBER to disconnect the power.

If you feel you do not have enough electrical wiring knowledge or experience, have your fan installed by a licensed electrician.

Follow the steps below to connect the fan to your household wiring. Use the wire nuts supplied with your fan. Secure the wire nuts with electrical tape. Make sure there are no loose strands or connections.

1. Connect the ground conductor of the 120V supply (this may be a bare wire or a wire with green colored insulation) to the green ground lead(s) of the fan (Figure 13). When using standard ceiling mounting, there are two green grounding leads; one from the ceiling mounting bracket and one from the ball/downrod assembly. When using “Close-to-Ceiling” mounting, there is only one green ground lead from the ceiling mounting bracket since the ball/downrod assembly is not used.
2. Connect the fan motor white wire to the supply white (neutral) wire using a wire nut. (Figure 13)

3. Connect the fan motor black wire to the supply black (hot) wire using a wire nut (Figure 13).
4. Connect the blue wire for light kit to the black household supply wire.
5. Turn wire nut connections upward, spreading them apart so the green (ground) will be on one side of the outlet box and the white, black and blue wire will be on the other side, and push carefully up into the outlet box.

WARNING

CHECK TO SEE THAT ALL CONNECTIONS ARE TIGHT, INCLUDING GROUND, AND THAT NO BARE WIRE IS VISIBLE AT THE WIRE NUTS. EXCEPT FOR THE GROUND WIRE.

WARNING

ELECTRICAL DIAGRAMS ARE FOR REFERENCE ONLY. OPTIONAL USE OF ANY LIGHT KIT SHALL BE UL LISTED AND MARKED SUITABLE FOR USE WITH THIS FAN.

WARNING

TO REDUCE THE RISK OF FIRE OR ELECTRIC SHOCK. DO NOT USE THIS FAN WITH ANY SOLID-STATE SPEED CONTROL DEVICE.

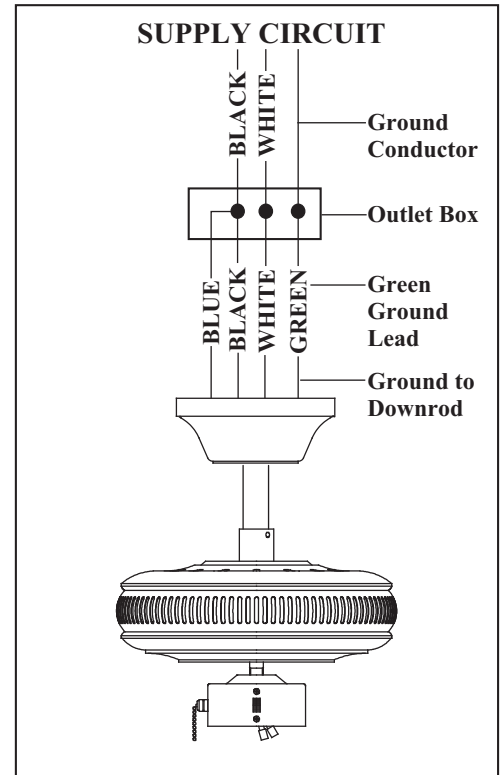

Figure 13

Finishing the Fan Installation

Standard Ceiling Mounting

WARNING

LOCKING SLOTS OF CEILING CANOPY ARE PROVIDED ONLY AS AN AID TO MOUNTING. DO NOT LEAVE FAN ASSEMBLY UNATTENDED UNTIL ALL FOUR CANOPY SCREWS ARE ENGAGED AND FIRMLY TIGHTENED.

Slide canopy up to the ceiling as shown in Figure 14. Make sure you place the wires safely into the outlet box. Secure the canopy to the hanger bracket with the four screws with your fan.

WARNING

MAKE SURE THE TAB ON THE HANGING BRACKET PROPERLY SITS IN THE GROOVE IN THE HANGER BALL BEFORE ATTACHING THE CANOPY TO THE BRACKET BY TURNING THE HOUSING UNTIL IT DROPS INTO PLACE.

Close-to-Ceiling Mounting

Remove the fan from the hook on the hanger bracket. Secure the canopy to the hanger bracket with four screws included with your fan. (Fig. 15)

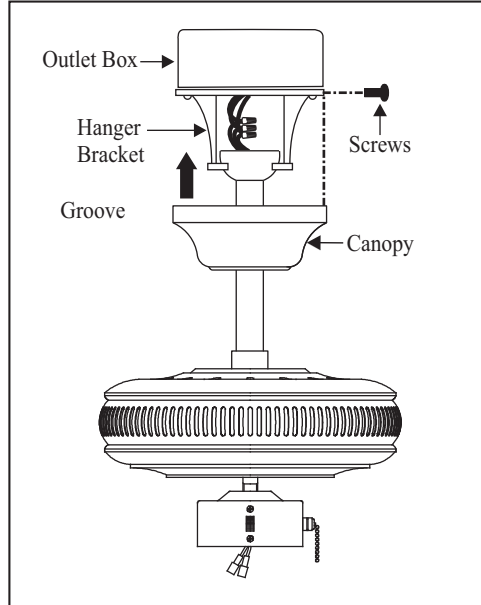

Figure 14

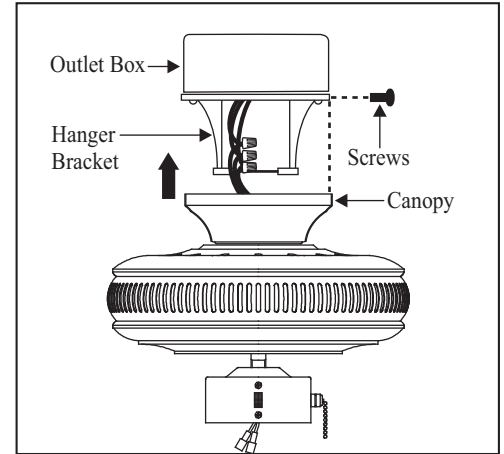

Figure 15

Attaching the Fan Blades

CAUTION

MOTOR IS SHIPPED WITH RUBBER MOTOR STOPS TO PREVENT MOVEMENT DURING TRANSPORTATION. REMOVE MOTOR STOPS PRIOR TO ATTACHING BLADE BRACKETS. (FIG. 16)

1. Attach blades to blade arms using three screws with fiber washers. (Fig. 17) Start a screw into the blade arm, do not tighten. Repeat for the 2 remaining screws and washers.
2. Tighten each screw securely starting with the center screw. Make sure the blade is straight. Repeat steps for the remaining blades.
3. Fasten the blade assemblies to the motor housing by lining up the slots of the blade arms with the tabs on the motor housing, then tighten the two screws and washers already installed in the blade arms. (Fig. 18)

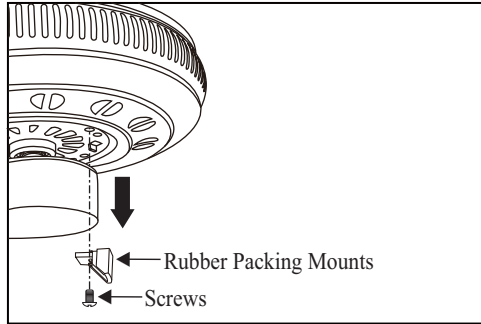

Figure 16

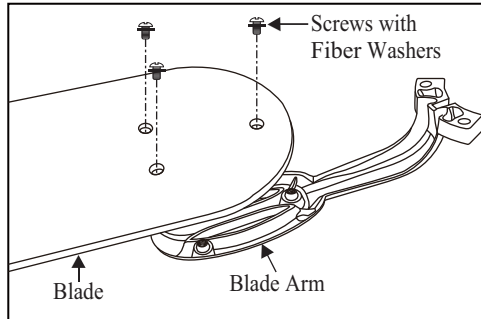

Figure 17

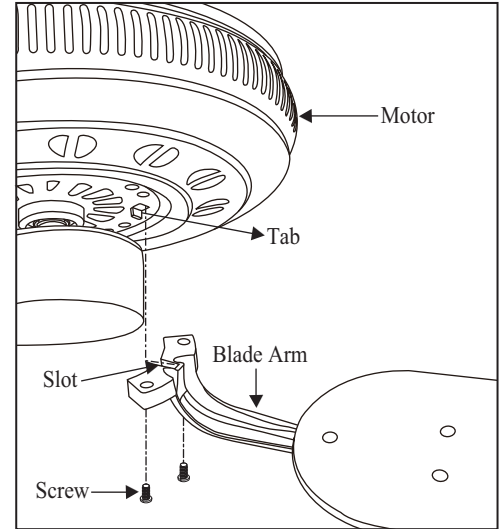

Figure 18

WARNING

TO REDUCE THE RISK OF PERSONAL INJURY, DO NOT BEND THE BLADE ARMS WHILE INSTALLING, BALANCING THE BLADES, OR CLEANING THE FAN. DO NOT INSERT FOREIGN OBJECTS BETWEEN ROTATING FAN BLADES.

Blade Balancing

The following procedure should correct most fan wobble. Check after each step.

1. Check that all blade and blade bracket screws are secure.
2. Most fan wobble problems are caused when blade levels are unequal. Check this level by selecting a point on the ceiling above the tip of one of the blades. Measure from a point on the center of each blade to the point on the ceiling. Measure this distance as shown in Figure 19. Rotate the fan until the next blade is positioned for measurement. Repeat for each blade. Measurements deviation should be within $1/8"$. Run the fan for 10 Minutes.
3. Use the enclosed Blade Balancing Kit if the blade wobble is still noticeable.

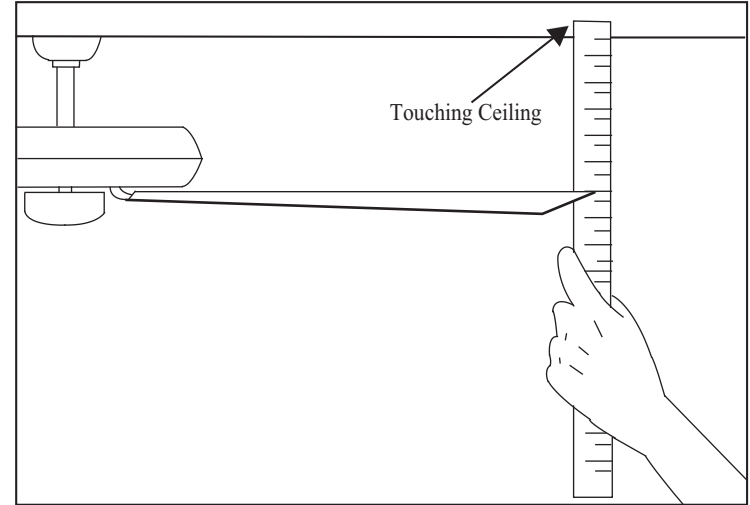

Figure 19

Installing the Light kit

CAUTION

BEFORE STARTING INSTALLATION, DISCONNECT THE POWER BY TURNING OFF THE CIRCUIT BREAKER OR REMOVING THE FUSE AT FUSE BOX. TURNING POWER OFF USING THE FAN SWITCH IS NOT SUFFICIENT TO PREVENT ELECTRIC SHOCK.

NOTE

LIGHT BULBS HAVE NO WARRANTY; CAN BE PURCHASED AT ANY HOME DEPOT STORE.

1. While holding the light kit under your fan, locate two single white and blue wires in the switch housing labeled "FOR LIGHT". Make the polarized plug connections:
 - White to white
 - Blue to black
2. Carefully push all wires back into the switch housing. Attach the light kit fitter by aligning its keyhole slots with the three screw holes and the reverse switch on the side of the switch housing. Tighten the three screws securely to prevent the light kit from vibrating loose. (Fig. 20)
3. Mount the glass shades to the light fixture by unscrewing partway the thumbscrews on the glass holders, insert the glass, then gently tighten the thumbscrews by hand evenly to the glass. **DO NOT OVER TIGHTEN** (Fig. 21).
4. Install three 13 Watt compact fluorescent bulbs (included). **NOTE:** CFL bulbs are **NOT** dimmable.

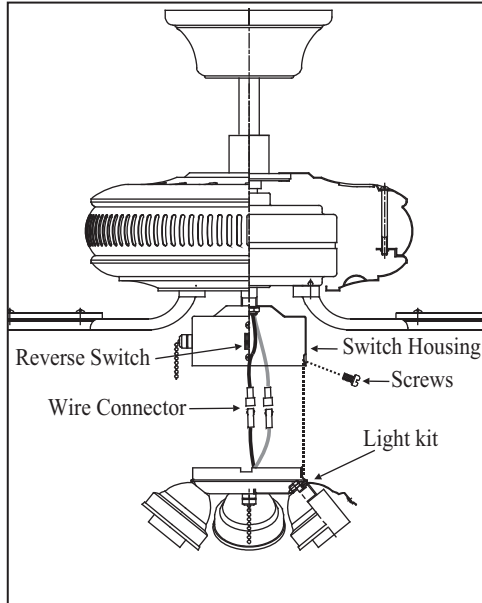

Figure 20

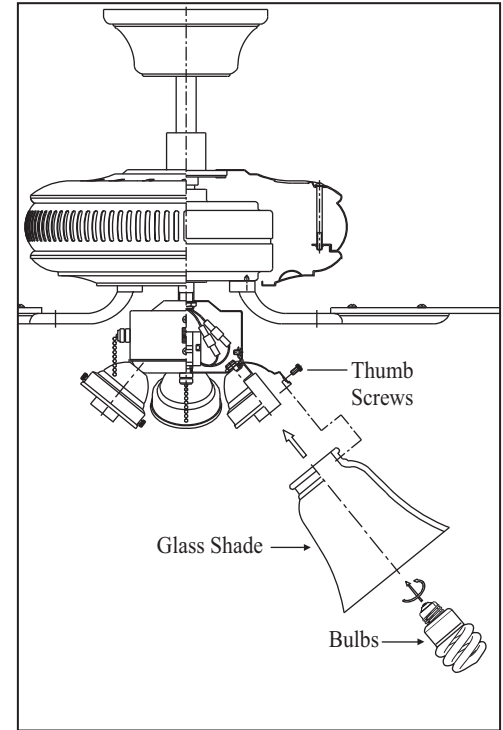

Figure 21

Operating Your Fan

WARNING

LOCKING SLOTS OF CEILING CANOPY ARE PROVIDED ONLY AS AN AID TO MOUNTING. DO NOT LEAVE FAN ASSEMBLY UNATTENDED UNTIL ALL FOUR CANOPY SCREWS ARE ENGAGED AND FIRMLY TIGHTENED.

NOTE

WAIT FOR FAN TO STOP BEFORE REVERSING THE DIRECTION OF THE BLADE ROTATION.

Turn on the power and check the operation of the fan. The pull chain controls the fan speed as follows: 1 pull - High, 2 pulls - Medium, 3 pulls - Low and 4 pulls - Off.

Speed settings for warm or cool weather depend on factors such as the room size, ceiling height, number of fans, and so on.

Light kit pull chain- it controls the light kit in "ON" or "OFF".

The slide switch controls directions: forward (switch down) or reverse (switch up).

Warm weather - (Counter Clockwise Direction) A downward air flow creates a cooling effect as shown in Figure 22. This allows you to set your air conditioner on a higher setting without affecting your comfort.

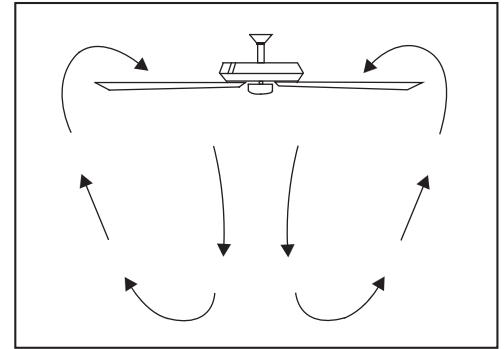

Figure 22

Cool weather - (Clockwise Direction) An upward air flow moves warm air off the ceiling as shown in Figure 23. This allows you to set your heating unit on a lower setting without affecting your comfort.

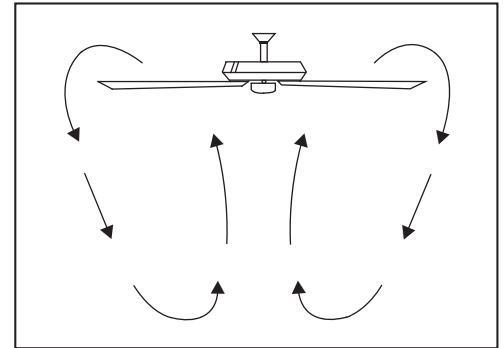

Figure 23

Care of Your Fan

Here are some suggestions to help you maintain your fan.

1. Because of the fan's natural movement, some connections may become loose. Check the support connections, brackets, and blade attachments twice a year. Make sure they are secure. (It is not necessary to remove fan from ceiling.)
2. Clean your fan periodically to help maintain its new appearance over the years. Do not use water when cleaning. Use only a soft brush or lint-free cloth to avoid scratching the finish. The plating is sealed with a lacquer to minimize discoloration or tarnishing. Do not use water when cleaning. This could damage the motor, or the wood, or possibly cause an electrical shock.
3. You can apply a light coat of furniture polish to the wood blades for additional protection and enhanced beauty. Cover small scratches with a light application of shoe polish.
4. There is no need to oil your fan. The motor has permanently lubricated sealed ball bearings.

Troubleshooting

PROBLEM SOLUTION

Fan will not start

1. Check main and branch circuit fuses or breakers.
2. Check line wire connections to the fan and switch wire connections in the switch housing.

Fan sounds noisy

1. Make sure all motor housing screws are snug.
2. Make sure the screws that attach the fan blade bracket to the motor hub is tight.
3. Make sure wire nut connections are not rattling against each other or the interior wall of the switch housing.
4. Allow a 24-hour "breaking-in" period. Most noises associated with a new fan disappear during this time.
5. If using an optional light kit, make sure the screws securing the glassware are tight. Check that the light bulb is also secure.
6. Make sure there is a short distance from the ceiling to the canopy. It should not touch the ceiling.
7. Make sure your ceiling box is secure and rubber isolator pads are used between mounting bracket and outlet box.

WARNING

MAKE SURE THE POWER IS OFF AT THE ELECTRICAL PANEL BOX BEFORE YOU ATTEMPT ANY REPAIRS. REFER TO THE SECTION, "MAKING ELECTRICAL CONNECTIONS".

Specifications

FAN SIZE	SPEED	VOLTS	AMPS	WATTS	RPM	CFM	N.W.	G.W.	C.F.
52"	LOW	120	0.21	9.84	58	1491.18	8.5 kgs (18.7 lbs)	9.2 kgs (20.2 lbs)	1.71'
	MED.		0.38	31.07	118	2978.10			
	HIGH		0.53	63.96	170	4519.37			

These are approximate measures. They do not include Amps and Wattage used by the light kit .

Hampton Bay Lifetime Limited Warranty

(lifetime warranty on motor)

The Hampton Bay warrants the fan motor to be free from defects in workmanship and material present at time of shipment from the factory for a period of lifetime after the date of purchase by the original purchaser. Hampton Bay also warrants that all other fan parts, excluding any glass or acrylic blades, to be free from defects in workmanship and material at the time of shipment from the factory for a period of one year after the date of purchase by the original purchaser. We agree to correct such defects without charge or at our option replace with a comparable or superior model if the product is returned to Hampton Bay. To obtain warranty service, you must present a copy of the receipt as proof of purchase. All costs of removing and reinstalling the product are your responsibility. Damage to any part such as by accident or misuse or improper installation or by affixing any accessories, is not covered by this warranty. Because of varying climatic conditions this warranty does not cover any changes in brass finish, including rusting, pitting, corroding, tarnishing or peeling. Brass finishes of this type give their longest useful life when protected from varying weather conditions. A certain amount of “wobble” is normal and should not be considered a defect. Servicing performed by unauthorized persons shall render the warranty invalid. There is no other express warranty. Hampton Bay hereby disclaims any and all warranties, including but not limited to. Those of merchantability and fitness for a particular purpose to the extent permitted by law. The duration of any implied warranty which cannot be disclaimed is limited to the time period as specified in the express warranty. Some states do not allow limitation on how long an implied warranty lasts, so the above limitation may not apply to you. The retailer shall not be liable for incidental, consequential, or special damages arising out of or in connection with product use or performance except as may otherwise be accorded by law. Some states do not allow the exclusion of incidental or consequential damages, so the above exclusion or limitation may not apply to you. This warranty gives specific legal rights, and you may also have other rights which vary from state to state. This warranty supersedes all prior warranties. Shipping costs for any return of product as part of a claim on the warranty must be paid by the customer.

You must present a copy of the original purchase receipt to obtain warranty service.

Ceiling Fan Parts & Service Department
2919 E. Philadelphia Street
Ontario, CA 91761
U.S.A.

Attach receipt here for easy location