

# HOW TO INSTALL YOUR SUSPENDED CEILING



We are constantly working to improve our instructions with learnings from customers like you. For the most up-to-date instructions, please visit [ceilings.com/installation](http://ceilings.com/installation). If you need additional guidance, call our Techline at 1-877-ARMSTRONG.

## Safety Tips

- See Warning statements elsewhere on this document.
- Work Site Environment: Initially there may be a potential adverse impact on indoor air quality within the general work area during the installation process. During installation, adequate ventilation of the work area should be

maintained without causing the entry of contaminants to other parts of the building. Persons who are sensitive to odor and or chemicals should avoid the work area during this process.

## Important Information:

- Store and install panels in areas with a temperature range of 60° to 80°F and not more than 70% relative humidity.
- Remove panels from the cartons 24 hours before installation and allow them to adjust to normal interior conditions of the area where installation will take place.
- Never install ceiling panels below an existing ceiling that contains imbedded radiant-heat coils.
- Do not apply loose fill or batt insulation so that it rests directly on the panels.
- Keep hands clean to avoid smudges on the finished ceiling.

- Always cut ceiling panels face up with a sharp utility knife.
- Main beams run the opposite direction of the joists.
- Main beams are on 4 foot centers.
- The minimum drop is 3 inches.
- Allow for drop-in lights by adding 2" to the height of the light for clearance.
- Locate Hidden joists by tapping on the ceiling until you hear a solid thud. Drive a nail in here. Repeat this to locate other joists and determine their direction.
- Mark the joist locations with chalklines.

## Planning Your Armstrong Ceiling

### Sample Room

- A** Joists Usually 16" on Center
- B** Snapped Chalk Lines in Center of Joists

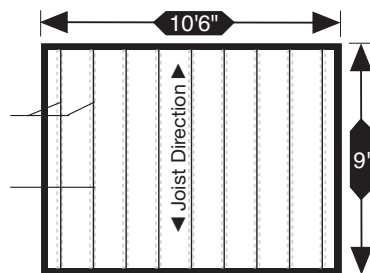

### Locate Hidden Joists to Install Wire Fasteners

1. Find joists **(A)**.
2. Drive nails to find exact center line of joists.
3. Snap chalk line for each joist **(B)**.

### Sample Room Panel Layout

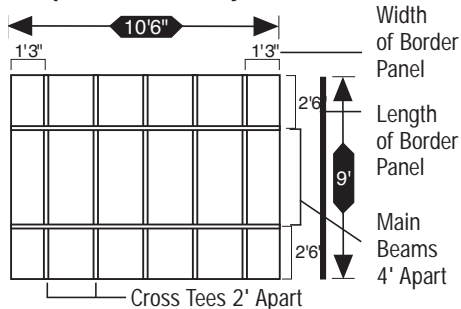

### Determine Panel Layout

1. Determine length of border panels.
2. Determine width of border panels.

For best appearance, border panels should be the same size on the opposite sides of the room. Use your room dimensions and follow the formula in the worksheets at right.

### Sample Worksheets, using 2' x 4' panels in a 9' x 10' 6" room.

Determine Length of Border Panels	
1. Divide width of room by length of single panel	$\frac{2'}{4' \mid 9'}$
	$\frac{-8}{-8}$
2. Add the remainder.....1' to length of single panel	$\frac{+ 4'}{= 5'}$
3. Divide it by 2 ... = 2' 6"	
<b>Length of the Border Panels is 2' 6"</b>	

\*Use 4 for 2' x 4' panel, 2 for 2' x 2' panel

Determine Width of Border Panels	
1. Divide length of room by width of single panel	$\frac{5'}{2 \mid 10'6"}$
	$\frac{-10}{-10}$
2. Add the remainder.....6' to width of single panel	$\frac{+ 2'}{= 2' 6"}$
3. Divide it by 2 ... = 1' 3"	
<b>width of the Border Panels is 1' 3"</b>	

\*Use 2 for 2' x 4' panel, 2 for 2' x 2' panel

## Tools Needed To Install Your Ceiling

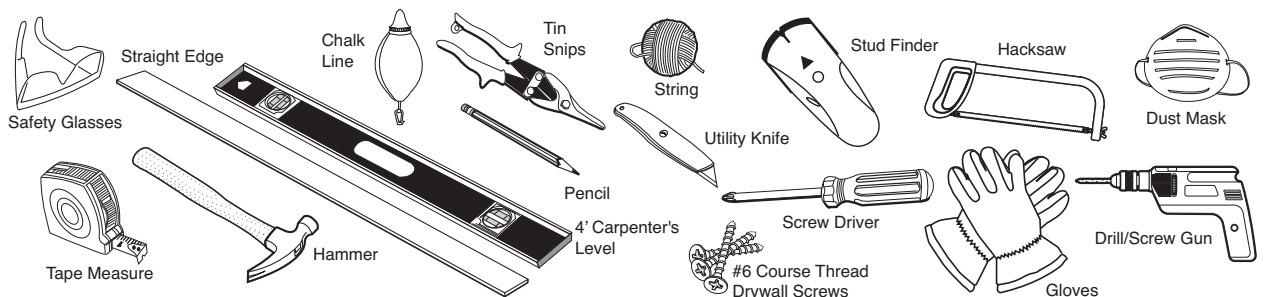

# THREE EASY STEPS TO INSTALL YOUR CEILING

**STEP 1**

## Install Wall Molding

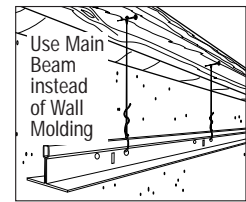
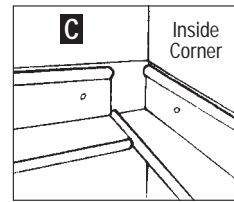
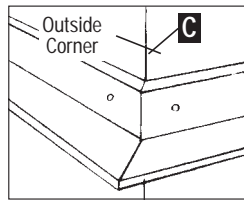
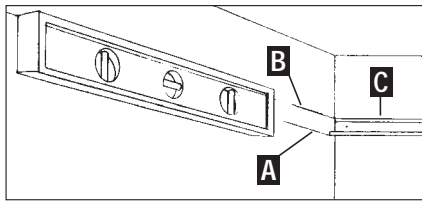

1. Mark height desired for new ceiling (A).
2. Add height of Wall Molding and mark a level line around 3 walls (B).
3. Snap a connecting chalk line on the 4th wall.
4. Nail Wall Molding to the wall studs (C).
5. If nailing molding directly to wall is not possible (for example, a solid concrete or stone wall), hang a section of main runner next to the wall as a substitute for regular wall molding.

**STEP 2**

## Install Suspension System

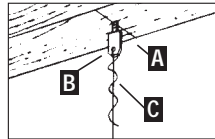
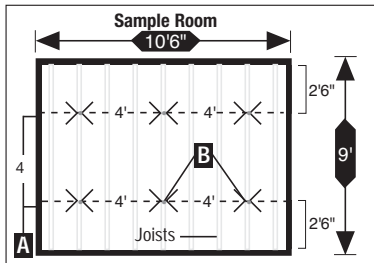

### Install Fasteners and Hanger Wires.

1. Snap Chalk Line for Main Beams 4' Apart (A).
2. Screw in Wire Fasteners 4' Apart (B).
3. Wrap hanger wire securely around itself 3 times (C).

NOTE: Add extra wires for light fixtures, one at each corner of the light.

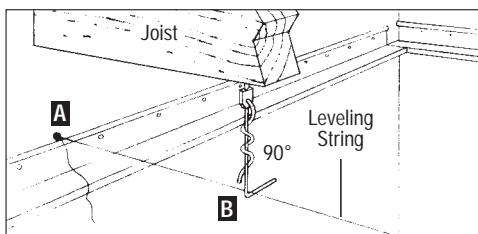

### Prebend Hanger Wires

1. Measure up 7/8" from the bottom of the molding. Drive nail into wall just above molding.
2. Do the same on other side of room. Stretch a string from nail to nail along a row of wires (A).
3. Swing hanger wires over to string and bend each one at 90° where they touch the string (B). Stretch additional strings to prebend other hanger wires, to help level entire ceiling.
4. Remove Leveling String(s) after prebending wires.

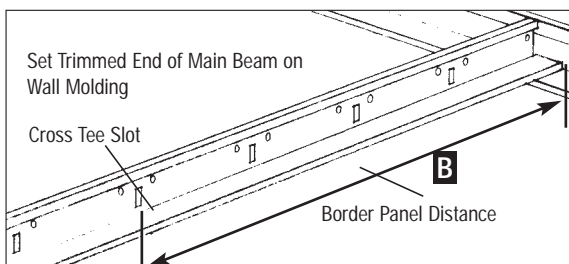

### Trim the Main Beam

Trim end of first Main Beam (A) so that a Cross Tee slot on the Main Beam is the border panel distance from the wall (B).

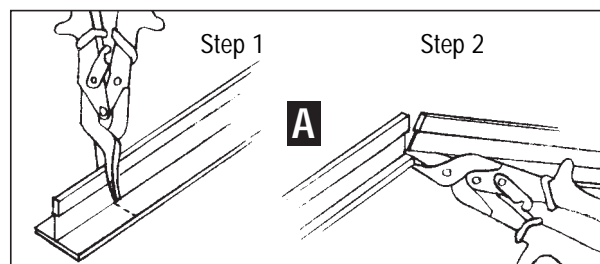

## THREE EASY STEPS TO INSTALL YOUR CEILING

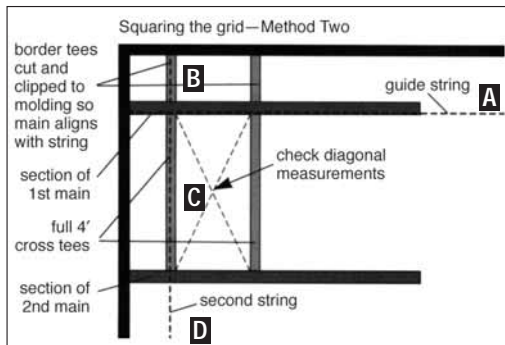

illus. A

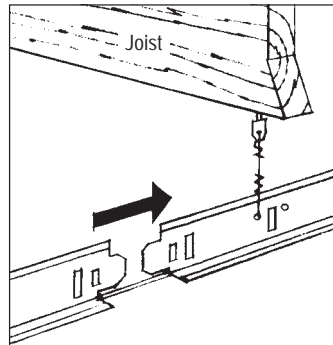

illus. B

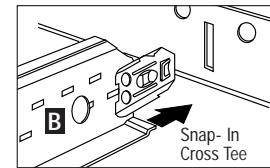

illus. C

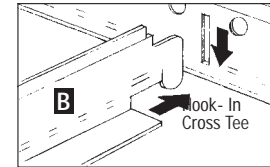

illus. D

### Hang First Main Beam

1. Stretch a guide string from one end of the room to the other below the molding where the first main beam will hang **(A)**. (illus. A)
2. Place the cut end of the main beam on the wall molding and insert a hanger wire in a hole near the other end of the main and wrap the wire around itself three times.
3. Insert the other wires into the main beam and wrap the wires around themselves three times.

### Cut Border Cross Tees

1. Find the location of the first border cross tee. (Border panel distance from end of main).
2. Place the end of the white face of the cross tee against the edge of the wall molding at the side and cut the cross tee where it crosses the guide string **(B)**. (illus. A)
3. Insert the uncut end of the cross tee into the main and rest the cut end of the tee on the molding
4. The far edge of the main should be directly above the string.
5. If you are using hook end cross tees, measure from the wall to the string and cut the cross tee to that length. The string will then line up with the near edge of the main.
6. Cut the second cross tee to length and insert it.
7. Temporarily fasten the tees to the wall molding so they do not move.

### Squaring the Grid

1. Now install the first section of the second row of mains after cutting off one end so a cross tee slot is the border panel distance from the end.
2. Install two four foot cross tees between the two mains in line with the first two border tees **(C)**. (illus. A)
3. Measure across the diagonals of the 2' x 4' opening. The measurements will be the same if the grid is square. If the measurements are not the same, shorten one of the mains until the diagonals are equal.
4. Complete the rows of mains joining the ends with the built-in splices. (illus. B)
5. Finish cutting border cross tees between the wall the first row of mains.
6. Use the left-over ends of the mains to start other rows of mains if your room requires them.
7. If you have additional rows of mains to install, stretch a second string from one side of the room to the other aligning it with the first 4 foot cross tee as shown **(D)**. (illus. A)
8. This second string will be your guide for cutting the remaining rows of mains. Just measure from the end wall to the string to determine the distance for the first cross tee slot you will use.
9. You must line up cross tee slots for the grid to be square!

### Install Grid

1. After the first section of main is installed in each row, and the grid is square, install the rest of the mains and cross tees. Use left over pieces of main to start succeeding rows of mains after cutting to align cross tee slots.
2. Measure and cut border cross at the other side of the room.

## THREE EASY STEPS TO INSTALL YOUR CEILING

### 2' x 2' Installation

1. If you are using 2' x 2' panels, you need to lay out your grid differently.
2. Determine the size of your border panels from side to side.
3. Place the first main beam the border panel distance plus 2 feet from the wall.
4. Cut 4 cross tees to the wall and insert 2' cross tees between the 4' cross tees to establish the border panel openings.
5. Your main beams will then fall on 4' centers from that point.

### Cutting "recessed grid" ceiling border panels

1. Trim reveal edge border panels to the same dimensions as for flat panels. The reveal edge detail must now be cut into the panel.
2. Set the panel into the grid. Draw a light pencil line on the panel using the wall molding as a guide.
3. Remove the panel. Use a sharp utility knife and straightedge to cut halfway through the panel from the face side along the pencil line.
4. Lay the utility knife on its side next to the panel and, with the panel face up, cut in at blade height for a reveal cut.
5. Remove the cut strip.
6. Fit the panel into the grid.

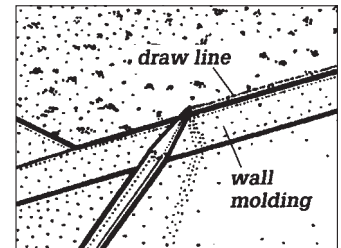

**STEP**  
**3**

### Install Panels

1. Lift panel at angle through grid; drop into place **(A)**.
2. Trim border panels, cutting panel face side up **(B)**.

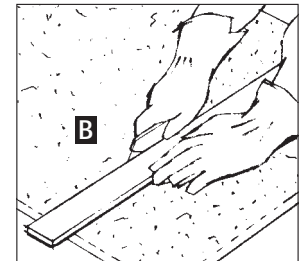
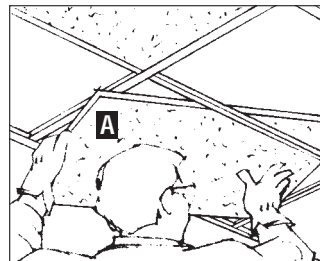

**Precautionary Measures:** Precautionary Measures: During the installation be certain that the work site is well ventilated and avoid breathing dust. Avoid contact with skin or eyes. Wear long-sleeve, loose fitting clothes, gloves and eye protection. Cut and trim with knife, razor or hand saw. Do not cut with power equipment unless either a dust collector is used on the equipment or local exhaust is used and a NIOSH approved respirator is worn to prevent overexposure to airborne silica. Exposures to respirable crystalline silica are not detected in industrial hygiene testing on workers installing acoustical ceiling panels for an 8 hour work day and are not expected during the normal use of this product; however, actual levels must be determined by workplace hygiene testing. Prolonged and repeated exposure to airborne free respirable crystalline silica can result in lung disease (i.e., silicosis) and/or lung cancer. Panels do not release respirable dust in their installed state and therefore do not present any known health hazards when installed and properly maintained.

**First Aid Measures:** If eye or skin contact occurs, flush with plenty of water for at least 15 minutes and remove contaminated clothing. After installing material, wash with warm water and mild soap.

Refer to Armstrong World Industries Safety Data Sheet for more information.

Made in the United States by Armstrong World Industries, Inc., Lancaster, Pennsylvania 17604.

If you have any technical or installation questions, or to request a Safety Data Sheet, please call: 1-877-ARMSTRONG.

Do not store or install under conditions where relative humidity exceeds 70%. (Except HumiGuard® Plus and HumiGuard® Max)  
Class A per ASTM E 1264.

**For additional information on installing suspended ceilings, including special installation tips, please visit our Web site at [ceilings.com](http://ceilings.com) or call 1-877-ARMSTRONG (276-7876).**

## LIMITED WARRANTY

**For warranty information, please visit [ceilings.com](http://ceilings.com)**