

# INSTALLATION & OPERATION MANUAL

# DECORATIVE VENTED

# GAS FIREPLACE LOG

## TIERED DUAL BURNER LOG SET



**Models: BRO18NG, BRO24NG - CSO24NG, CSO30NG  
MO18DBNG, MO24DBNG - SH18NG, SH24NG**

Burner set for use with these styles and sizes of SureHeat Dual Burner Natural Gas Log Sets. May be used with accessory valve kits: MBV300 (Manual Ball Valve) CVS303 and RVS304 (Safety Pilot Kits) Safety Pilot Kits also used for LP gas conversion - add ACC18 Burner Media

**WARNING:** If the information in this manual is not followed exactly, a fire or explosion may result causing property damage, personal injury or loss of life.

- Do not store or use gasoline or other flammable vapors and liquids in the vicinity of this or any other appliance.
- **WHAT TO DO IF YOU SMELL GAS**
  - Do not try to light any appliance.
  - Do not touch any electrical switch; do not use any phone in your building.
  - Immediately call your gas supplier from a neighbor's phone. Follow the gas supplier's instructions.
  - If you cannot reach your gas supplier, call the fire department.
- Installation and service must be performed by a qualified installer, service agency or the gas supplier.

Installation of this Energy Efficient Gas Log Set and provisions for combustion and ventilation air must conform with the National Fuel Gas Code ANSI Z223.1/NFPA54, and any local codes.

**⚠ WARNING:** This product contains and/or generates chemicals known to the State of California to cause cancer or birth defects, or other reproductive harm.

**INSTALLER:** Leave this manual with the appliance.

**CONSUMER:** Retain this manual for future reference.

# DUAL BURNER PARTS LIST

**STOP!** Verify that you have all of the listed parts **Figure 1** before attempting to install. If you do not have all the parts, or are not sure, or if you have broken logs, **DO NOT RETURN THE SET.** Instead, please call our Customer Service phone number - (800) 229-5647



1-6

Number of logs are determined by the size and model chosen. Sets range from 4 to 9 logs.

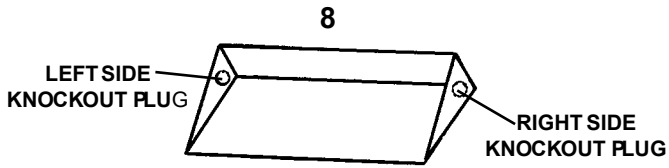
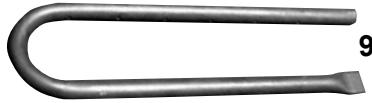
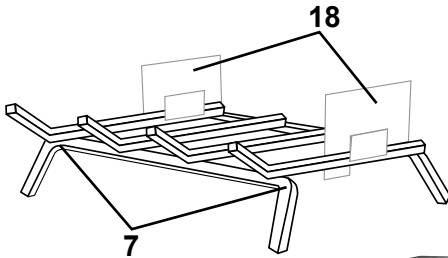

**GRANULES**  
(HEAVY WEIGHT BAG  
30" sets will have 2)

**GLOWING EMBERS**  
(LIGHT WEIGHT BAG)



16



17



19



20

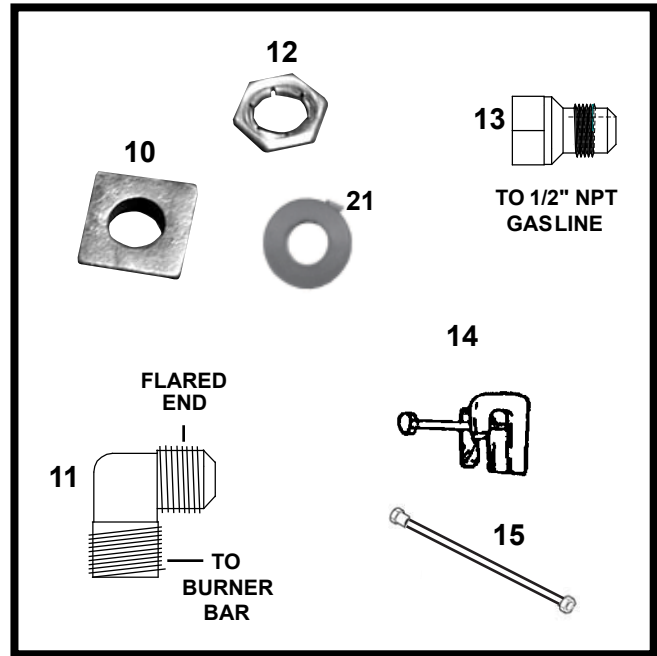

REF.	DESCRIPTION	PART NUMBER 18" SET	QTY.	PART NUMBER 24" SET	QTY.	PART NUMBER 30" SET	QTY.
1-6	Logs	—	—	—	—	—	—
7	Grate	RCORJ00003A	1	RCORJ00004A	1	RCOLC00013A	1
8	Burner Pan	SBNCJ00365A	1	SBNCJ00367A	1	SBNCJ00366A	1
9	Dual Burner Bar	RC0CB00002A	1	RC0CB00003A	1	RC0CB00004A	1
10	3/4" Burner Support Spacer	RMH-120-00420	1	RMH-120-00420	1	RMH-120-00420	1
11	3/8" Brass Orifice Elbow	RMH-120-00082	1	RMH-120-00082	1	RMH-120-00082	1
12	3/8" Locknut	RMH-120-00963	1	RMH-120-00963	1	RMH-120-00963	1
13	3/8" Flare to 1/2" NPT Inlet Fitting	RMH-120-00653	1	RMH-120-00653	1	RMH-120-00653	1
14	Damper Stop Clamp	RMH-120-00100	1	RMH-120-00100	1	RMH-120-00100	1
15	3/8" Flared Tubing	KHH-ACT16	1	KHH-ACT16	1	KHH-ACT16	1
16	Granules	WIP-130-00010	1	WIP-130-00010	1	WIP-130-00010	2
17	Glowing Embers	WIP-130-00300	1	WIP-130-00300	1	WIP-130-00300	2
18	Back Log Standoffs	SPSCJ00106A	2	SPSCJ00106A	2	SPSCJ00106A	2
19	Thread Sealant	RCSZZ00008A	1	RCSZZ00008A	1	RCSZZ00008A	1
20	Instruction Manual	RMH-130-OMVVL	1	RMH-130-OMVVL	1	RMH-130-OMVVL	1
21	Washer	RCODZ00145A	1	RCODZ00145A	1	RCODZ00145A	1

**WARNING:** If you do not follow these instructions exactly, a fire or explosion may result, causing property damage, personal injury or loss of life.

**WARNING:** Improper installation, adjustment, alteration, service or maintenance can cause injury or property damage. Refer to the owner's information manual provided with this appliance. For assistance or additional information consult a qualified installer, service agency or the gas supplier.

**WARNING:** For installation in a solid-fuel burning fireplace only. The fireplace chimney must have a permanent vent opening to atmosphere of not less than 49.2 square inches, or as determined from the manufacturer's installation instructions.

**NOTE:** The vent opening in the marking above shall be based on a 6-foot high chimney and the appliance input rate as shown under *MINIMUM FIREPLACE SIZE* on Page 4.

- This gas log set is only to be installed and burned in a fully vented fireplace with a fully functional damper and chimney that is free of any obstructions. The fireplace must be constructed of non-combustible materials and approved to burn wood.
- The smallest or minimum dimension of the chimney flue must be 8 inches in diameter. Do not use an Energy Efficient Gas Log Set if it is smaller than 8 inches. Do not use an Energy Efficient Gas Log Set if fumes from the burner emerge into the room when the damper is fully open. This indicates that there is not adequate draft for this log set and it must not be used until the fireplace draft is corrected.
- This appliance must be installed with a Damper Stop Clamp (Part #14). When operating this gas log set, the flue damper must be fully open.

**WARNING: Do not burn wood, solid fuels, or other material in any fireplace fitted with a gas log set.**

**FOR YOUR SAFETY:**

- Do not store or use gasoline or other flammable vapors and liquids in the vicinity of this or any other appliance.
- Do not place clothing or other flammable material on or near the appliance.
- A Fireplace screen must be in place when appliance is operating. Unless other provisions are made for combustion air, the fireplace screen must have openings for combustion air.
- Children and adults should be alerted to the hazards of high surface temperature and should be kept clear to avoid burns or clothing ignition.
- The minimum inlet gas pressure for this appliance is 7" water column for natural gas. The maximum inlet pressure is not to exceed 10" water column.
- This appliance must also be disconnected from the gas supply system by closing its individual manual shutoff valve during any pressure testing at pressure equal to or less than 1/2 PSIG.
- Do not use this appliance if any part has been under water. Immediately call a qualified service technician to inspect the appliance and to replace any part of the burner system which has been under water.

**FIREPLACE PREPERATION**

- A. Professionally clean chimney and fireplace floor of any combustible material to limit the smell from the system.
- B. Open fireplace damper fully and install Damper Stop Clamp with 1/4x2" set screw (Part 14#). This clamp is Designed to allow any combustion by-products to vent (See **Fig.2**) Should the Damper Stop Clamp supplied not fit, a permanent damper stop clamp must be installed that will keep the damper open at a distance of not less than 1 1/2".  
The damper must be in the fully open position anytime the unit is in operation.
- C. Prior to connecting the gas log set, make sure that the gas supply to the fireplace is completely shut off.

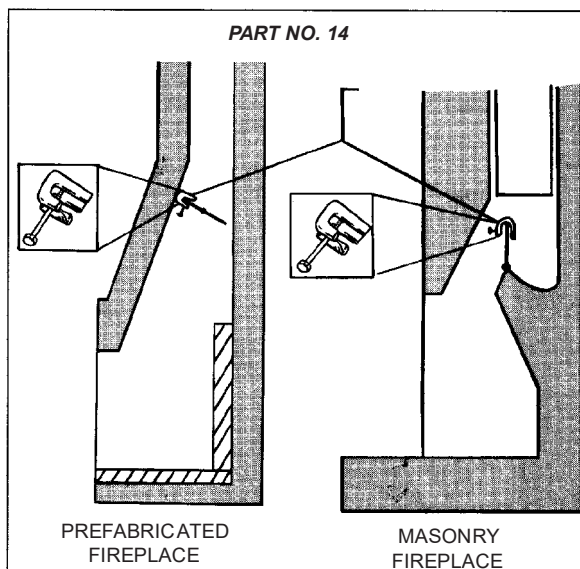

**Figure 2. Damper stop clamp**

- D. **Prefabricated fireplace:** Refer to the manufactures fireplace instruction manual for specific information regarding the running of a gas line into that particular model. A typical installation involves the insertion of a 1/2 inch gas pipe through the gas line tube provided by the manufacturer from **outside** the fireplace. The Knockout on the inside of the fireplace is removed as the gas pipe is punched through the fireplace. (See **Figure 3**).
- E. **Masonry fireplace:** A 1/2 inch gas supply line must be provided to the firebox. Most installations require drilling an access hole through the masonry wall. The supply line should be secured and sealed by mortar within the access hole. The supply line should also have a shutoff valve either in the wall or inside the fireplace (see **Figure 4**).

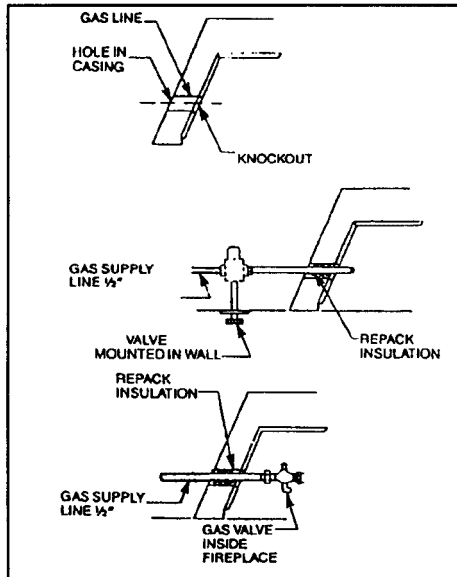

Figure 3. Gas line installation - Prefabricated Fireplace

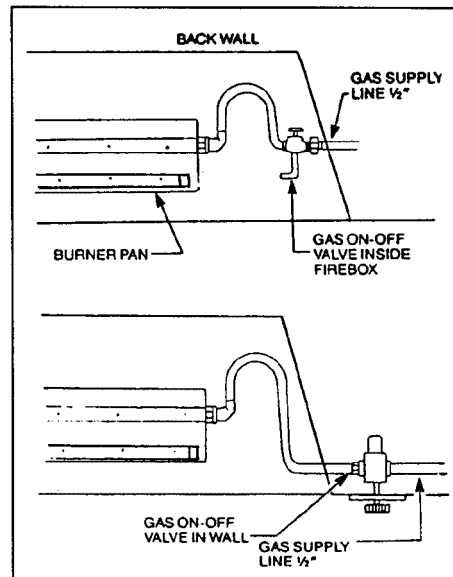

Figure 4. Gas line installation - Masonry Fireplace

## GAS LOG INSTALLATION

### MINIMUM FIREPLACE SIZE

Size	Depth	Height	Width	NG-BTU
18	12"	20"	20"	50,000
24	14"	24"	25"	60,000
30	14"	24"	32"	70,000

## BURNER PAN INSTALLATION

(See **Figure 1** Parts List as a guide to reference part numbers.)

**NOTE:** Use pipe compound on all male threads to seal joints.

- Determine if the fireplace has a right or left side gas line feed. The circular "Dimpled" hole covering must be knocked out on the appropriate side (right or left) of the burner pan.
 

**NOTE:** Brace pan on workbench when removing burner knock-out. Strike knock-out plug with a punch or drift.
- Locate 3/8" locknut (Part #12) and washer (Part #21), and attach them to the 3/8" brass orifice elbow (Part #11) Do not fasten the locknut on the "flare" end.
- Slide the 3/4" burner support spacer (Part # 10) over the Dual Burner bar (Part #9) and move spacer to opposite side of the gas inlet connection (See **Figure 6**).
- Secure the intake end of the Dual Burner bar (Part # 9) to the burner pan (Part # 8) through the knock-out hole selected (right or left hand) with the 3/8" brass orifice elbow (Part # 11), 3/8" locknut (Part # 12), and washer (Part #21) previously assembled in Step B (See **Figure 6**).
- Tighten elbow until firmly attached to the Dual Burner bar. Then, firmly tighten the attached lock-nut on the elbow to seal the burner bar to the wall of the burner pan.

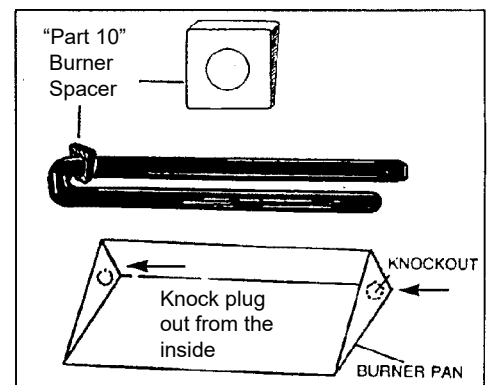

Figure 5. Burner bar placement

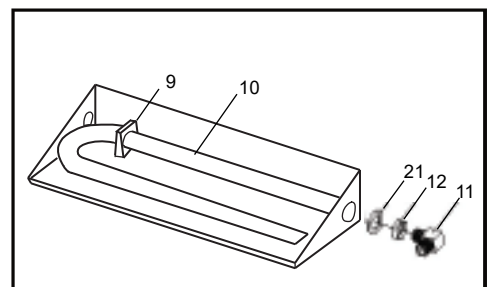

Figure 6. Burner bar connection

## CONNECTING GAS SUPPLY TO BURNER ASSEMBLY

Natural Gas applications only:

- A. Place burner pan assembly in the center of the fireplace.
- B. Attach 3/8" Flare X 1/2" NPT gas valve (Part #13) to the 1/2 inch gas supply stub already in fireplace. Be certain connections are tight and use pipe compound on all male NPT (pipe) threads to seal joints.
- C. Attach 3/8" flared tubing (Part #15) to burner pan assembly. Attach opposite end to gas supply line by carefully bending the flared tubing as needed to make the connection. Avoid kinking the tubing while bending. If tubing must be cut, use a tubing cutter. Flare the cut end of tube with a flaring tool.  
**NOTE:** A good method of bending the tube is to fill it with sand, bending the tube as needed to make the connection. This method will eliminate kinking in the line. Once the tube is in the desired configuration, be sure to **empty** the tube completely of any sand before tube is connected to the gas supply line and burner assembly.
- D. Be certain all connections are tight. Only use pipe compound on all male NPT (pipe) threads. Test all connections with a soapy water solution, and with the gas supply turned on. If bubbles appear on any connection, tighten and re-test. Once it is determined there are no leaks whatsoever, turn off gas supply and move to next assembly step.

## GRANULE, EMBER AND GRATE PLACEMENT



- A. Spread granules (Part # 16) over the installed burner pan. Granules should be sloped to the same angle as the burner pan filling the entire pan. (See Figure 7A.)
- B. Spread glowing embers (Part # 17) evenly over the top of the granules covering the entire surface area, concentrating on the front and sides of the burner pan for the most realistic burning effect.
- C. Place log grate (Part # 7) over the burner pan aligning as shown. (See Figure 7B.) Note that the burner pan is just ahead of the location of the log standoffs, with the front below the bend in the grate.
- D. Attach back log Standoff (Part # 18) to the back part of the grate. (See Figure 7B.)

**NOTE:** A hammer may be used to tap the back log stand-off in place. It may be necessary to squeeze the back log stand-off with pliers after attaching to the grate.

**WARNING:** For installation in a solid-fuel burning fireplace only. The fireplace chimney must have a permanent vent opening to atmosphere of not less than 49.2 square inches, or as determined from the manufacturer's installation instructions.

## LIGHTING YOUR GAS LOG SET

(Manual Valve / match lit only)

- A. This appliance must be lighted by hand each time it is used. When lighting the burner, follow these instructions exactly.
- B. Open chimney flue damper to the full open position.
- C. Turn your gas control manual valve (Figure 9) clockwise  to the full OFF position.
- D. Wait five (5) minutes to clear out any gas. If you then smell gas, STOP! Follow "A" in the safety Information above on this label. If you don't smell gas, go to the next step.
- E. Place a burning match on the surface of the burner embers (See Figure 8)  
**Do not hold match in hand.** Turn your manual gas valve counterclockwise  the ON position.

## TO TURN OFF GAS TO APPLIANCE

Turn the manual gas control valve (Figure 9) clockwise  to the OFF position.

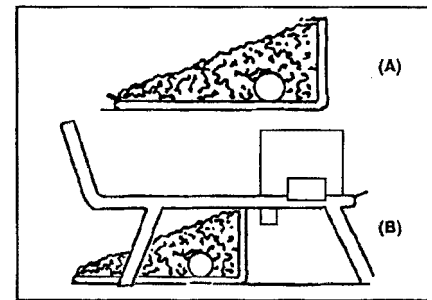

Figure 7 ( A & B ) Granule and Grate Placement

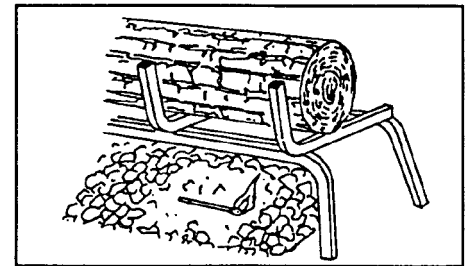

Figure 8. Lighting the log set



Figure 9. Example of Manual gas valve (MBV300 shown)

# LOG PLACEMENT

## MODEL: BRO18NG

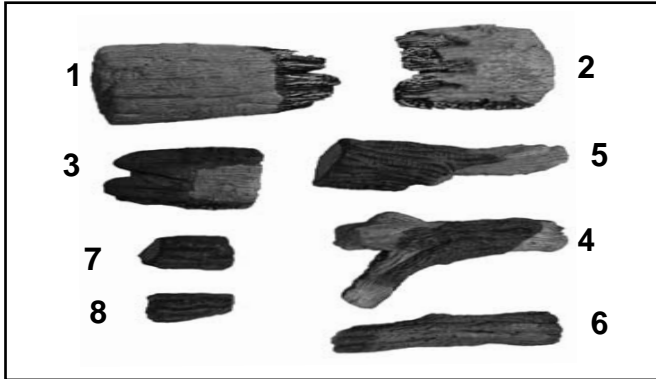

**Log Identification**

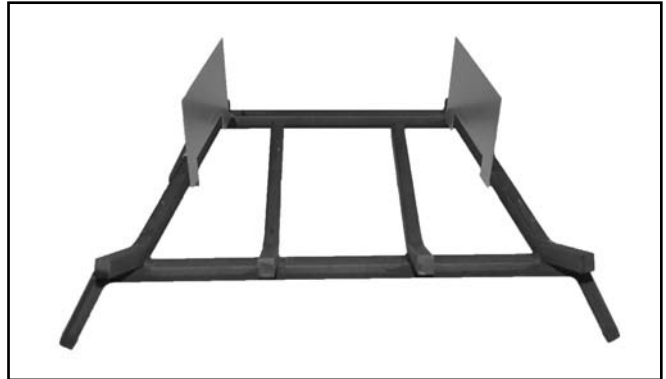

**Back Log Stand-Offs in place**



**Place log (1) onto back left area of the grate, perpendicular to log (2)**



**Place log (3) at the front right of the grate with the "burned" area to the flame**



**Place "Y" shaped log (4) onto left of the grate ahead of raised area**

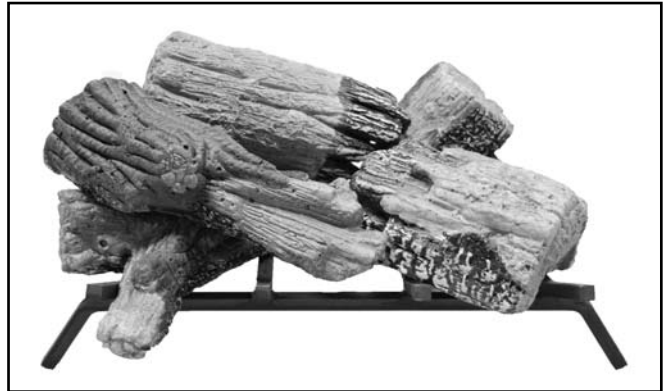

**Place log (5) atop log (4), brace on left center grate finger**



**Place log (6) atop logs (1) and (3)**

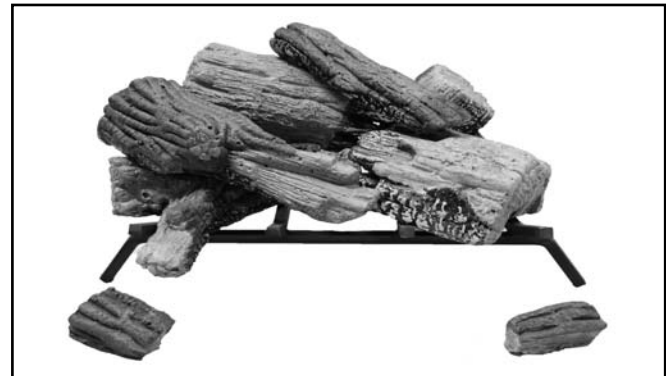

**Place the two small logs (7) and (8) in front of the grate as shown**

# LOG PLACEMENT

MODEL: BRO24

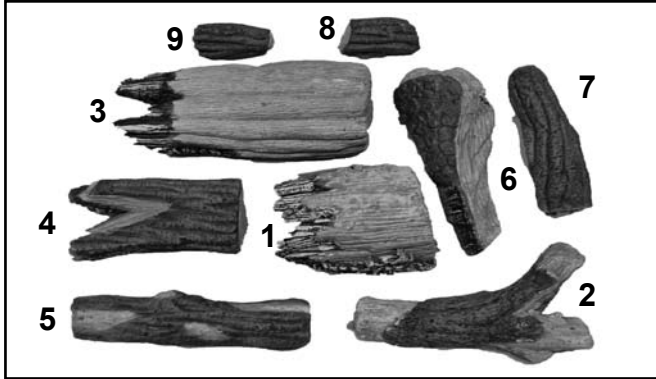

Log Identification



Back Log Stand-Offs in place

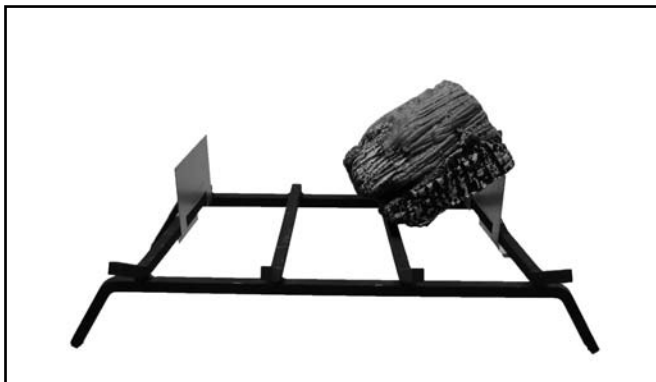

Place log (1) onto back right area of the grate

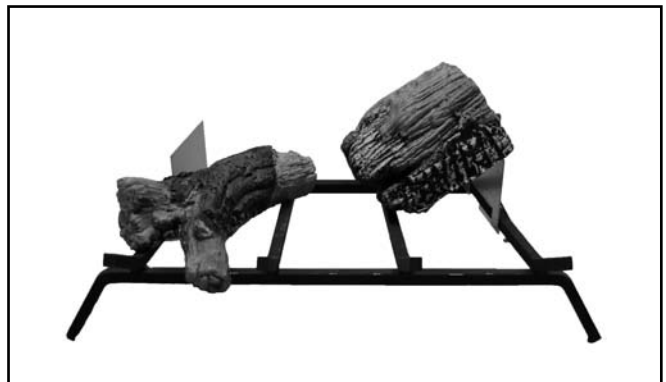

Place "Y" shaped log (2) onto left of the grate ahead of raised area

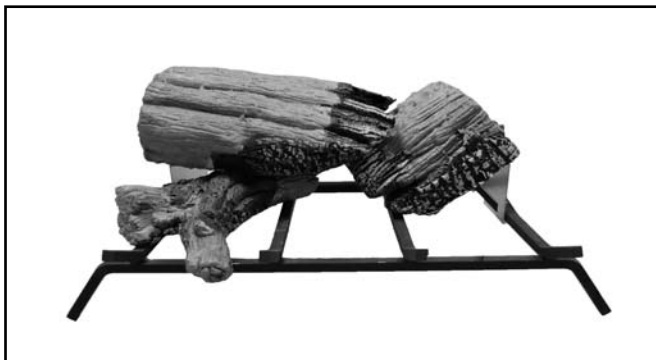

Place log (3) onto back left area of the grate, perpendicular to log (1)

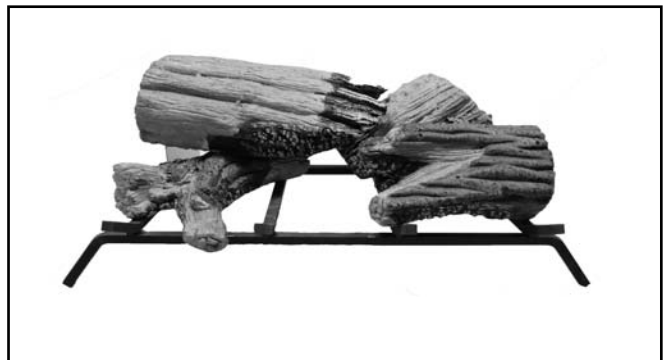

Place log (4) at the front right of the grate with the "split" area to the flame

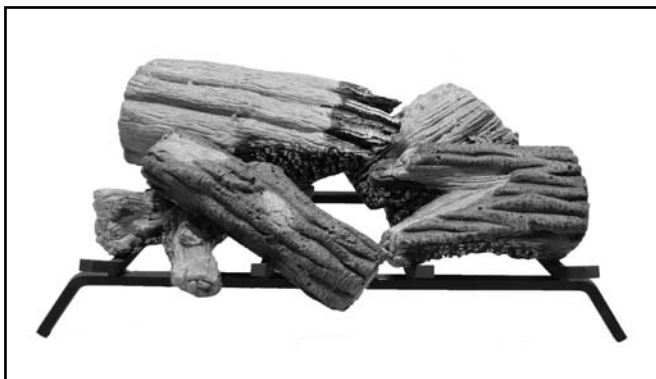

Place log (5) on to log (2) and brace it on the grate finger left of center

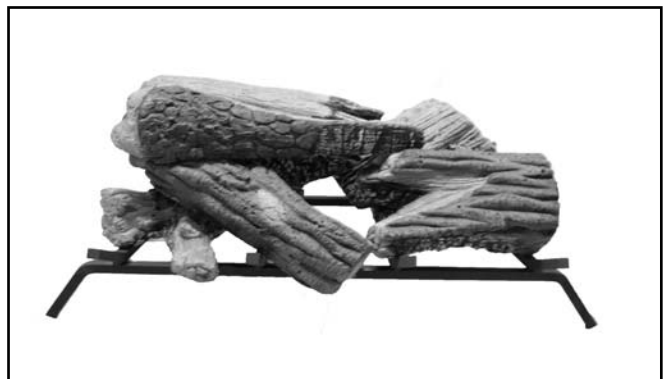

Place log (6) atop logs (5) and (4) as shown

# LOG PLACEMENT

## MODEL: BRO24 Continued

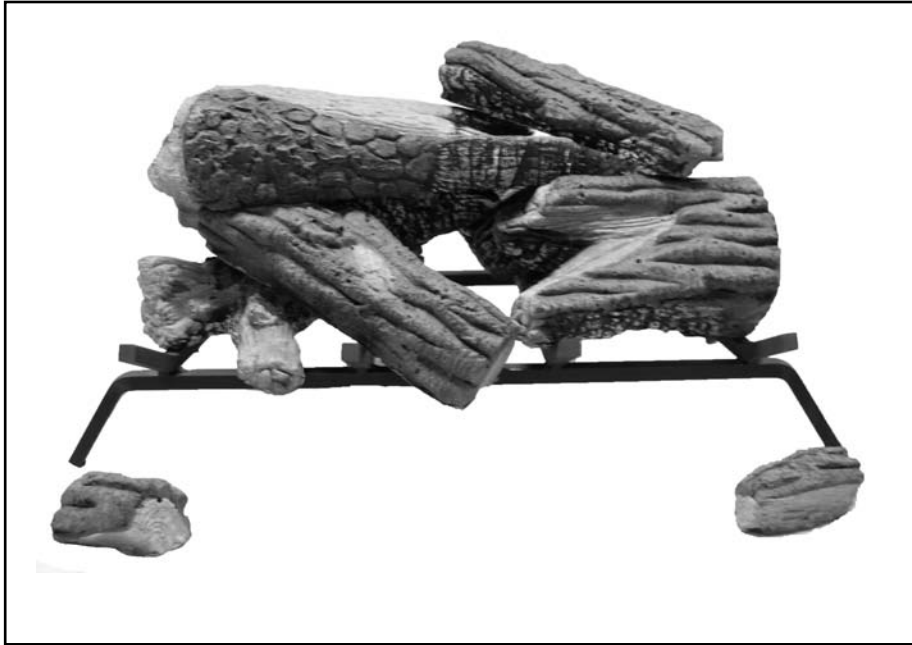

**Place the two small logs (7) and (8) in front of the grate as shown**



# LOG PLACEMENT

## MODEL: CSO24/CSO30

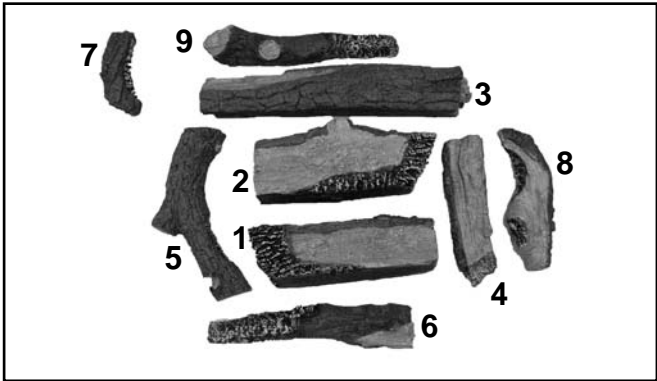

**Log Identification**

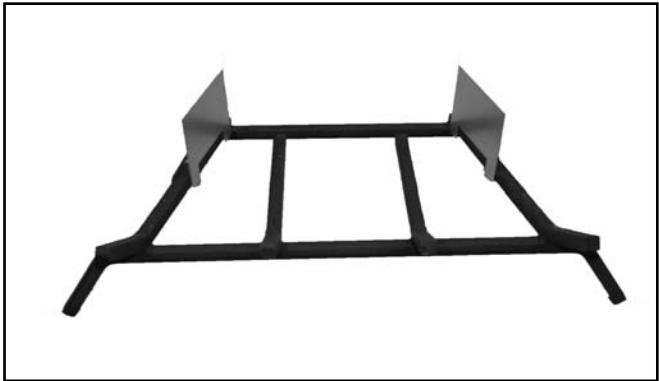

**Back Log Stand-Offs in place**

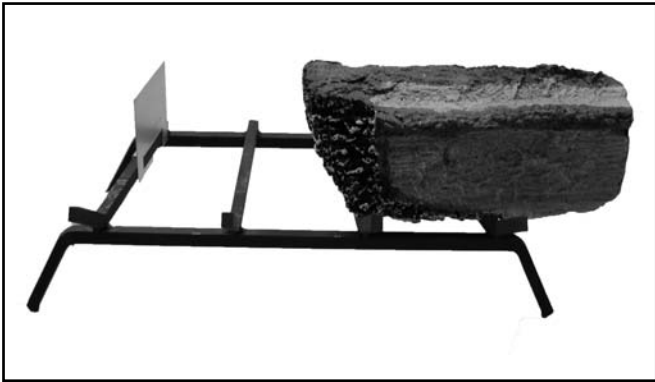

**Place Right front log (1) onto front area of the grate**



**Place left front log (2) onto front area of the grate**

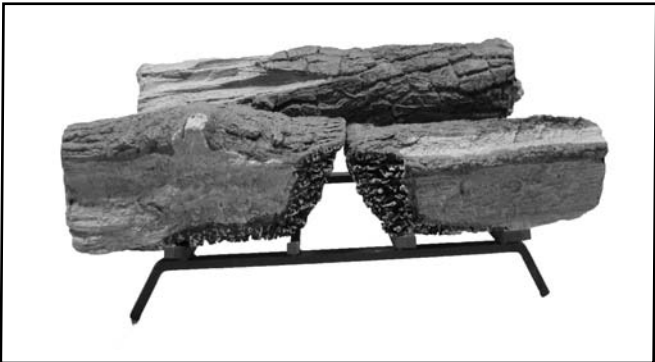

**Place back log (3) onto raised area of the grate**



**Place Cross-Log (4) at the center left**



**Place "Y" shaped Cross-Log (5) at right**

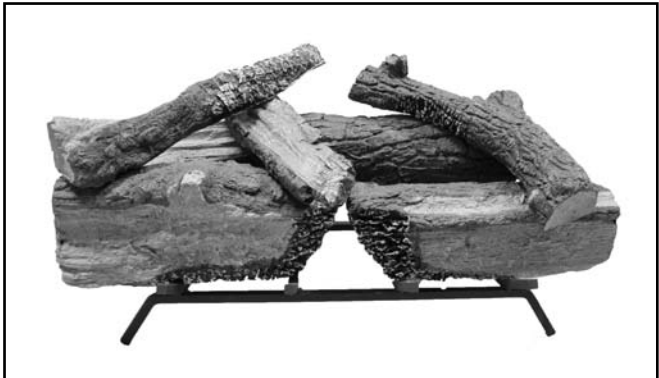

**Place Cross-Log (6) from front left to lay on log (5) as shown**

# **LOG PLACEMENT**

## **MODEL: CSO24/CSO30 Continued**

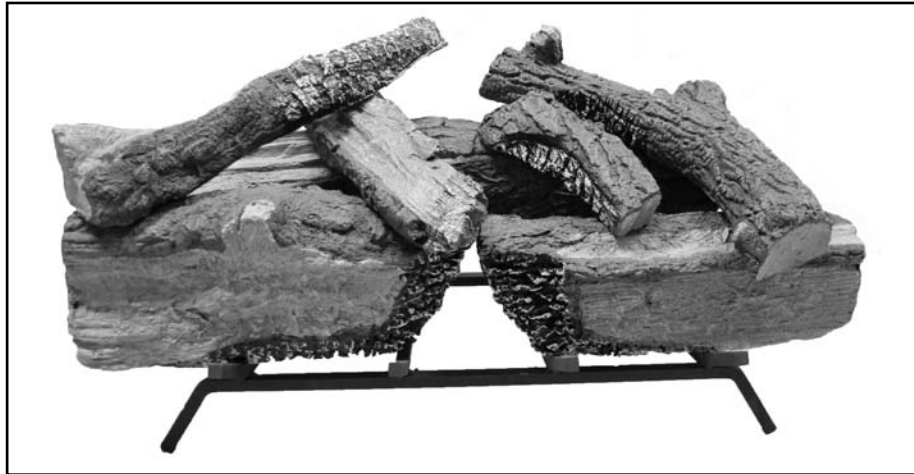

**Place Cross-Log (7) at the center right**



**Place Cross-Log (8) at the top center  
across logs (5) and (7)**



**Place log (9) in front of the set, on the fireplace floor  
(Make sure it is in front of the burner pan)**

# LOG PLACEMENT

## MODEL: MO18NG and MO24NG

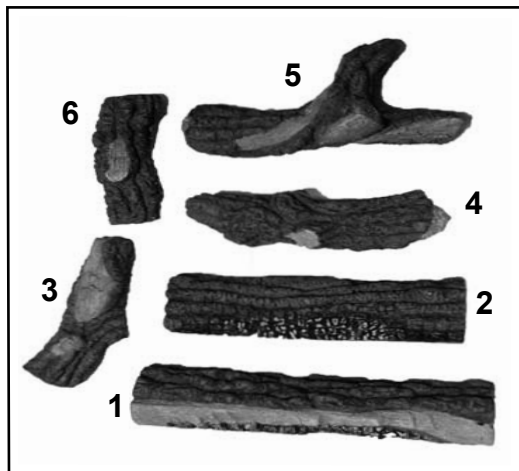

Log Identification MO18NG

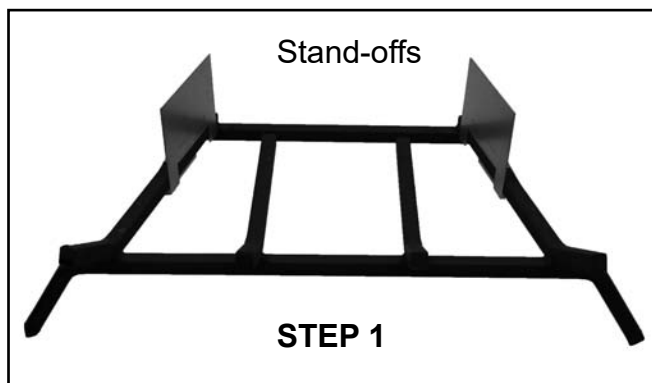

Back Log Stand-Offs in place

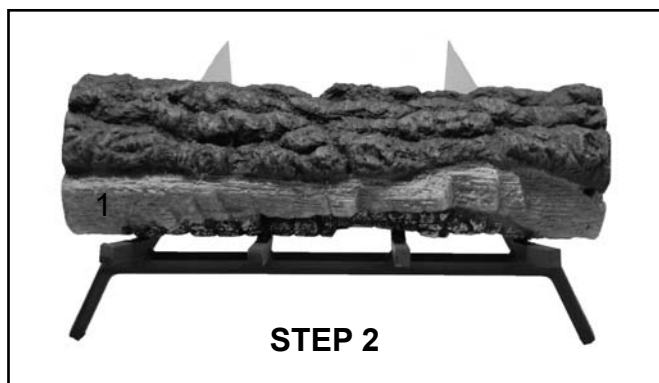

Place Main Front Log (1) onto front area of the grate

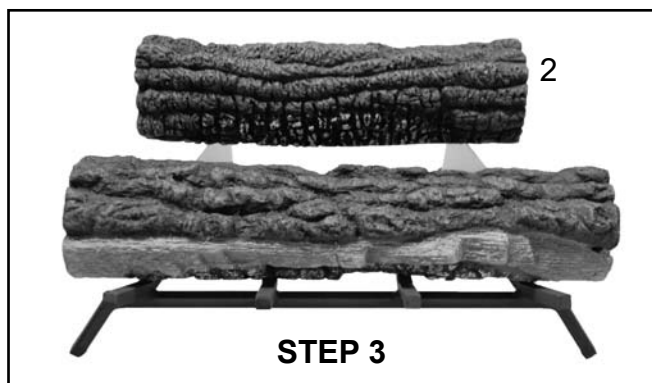

Place shorter back log (2) onto Back Log Stand-Offs

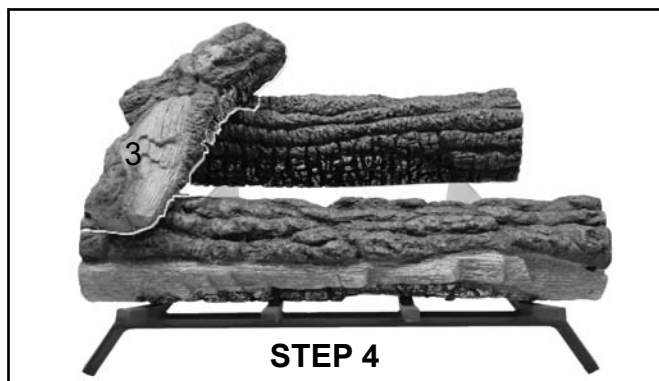

Place Cross-Log (3) at the left side

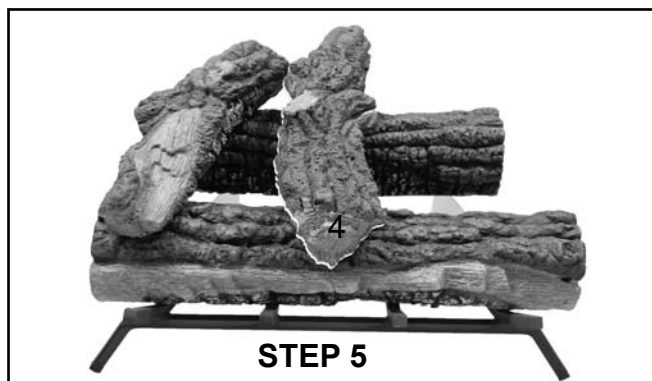

Place Cross-Log (4) at the center

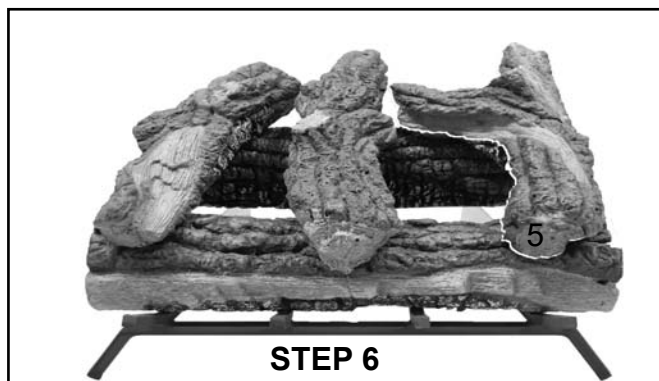

Place Cross-Log (5) at the right side

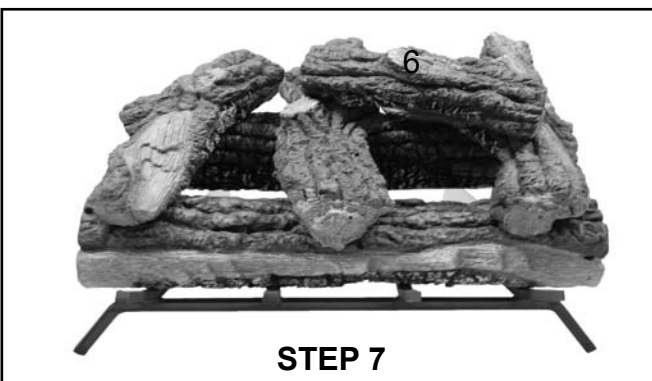

Place Cross-Log (6) from the center to the right side

# LOG PLACEMENT

## MODEL: MO24NG (Continued)

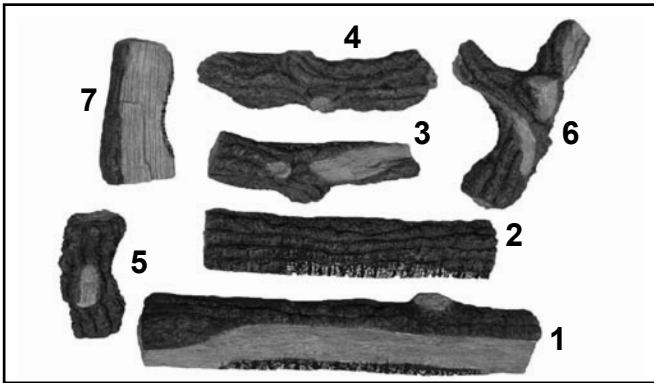

Log Identification MO24NG

Follow the first five steps from MO18NG on previous page.

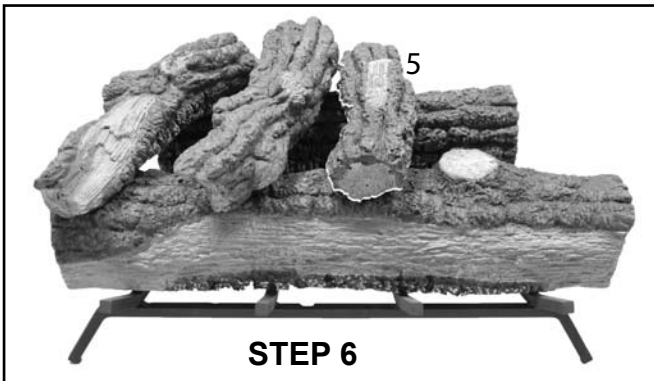

STEP 6

Place Cross-Log (5) at the center right

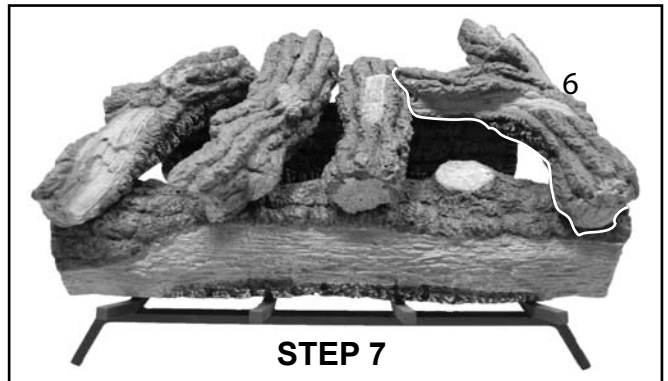

STEP 7

Place "Y" Shaped Cross-Log (6) at the right side as shown

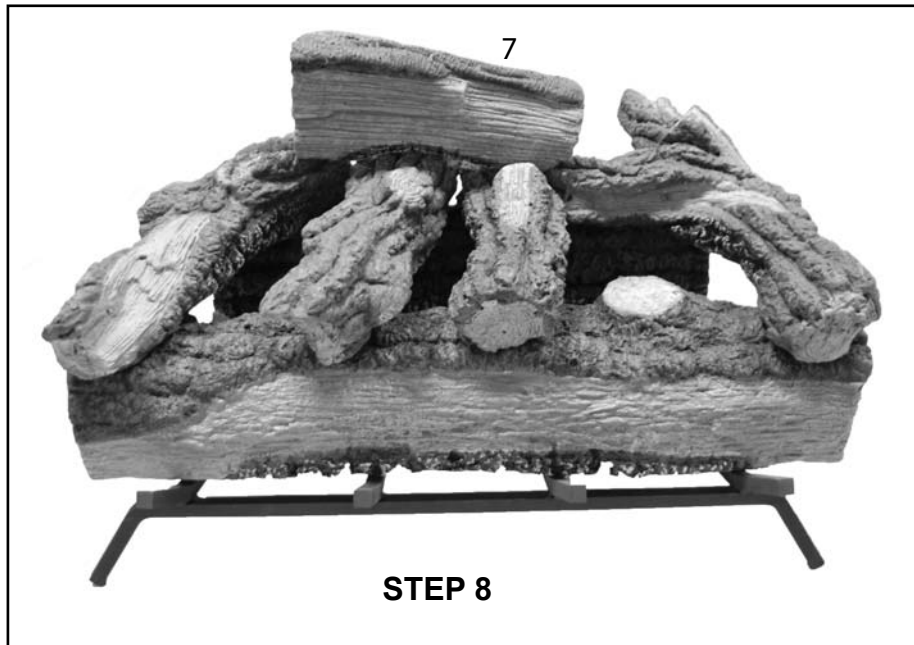

STEP 8

Place Cross-Log (7) atop the center  
Left (4) to the center right (5) logs

# LOG PLACEMENT

MODEL: SH18NG

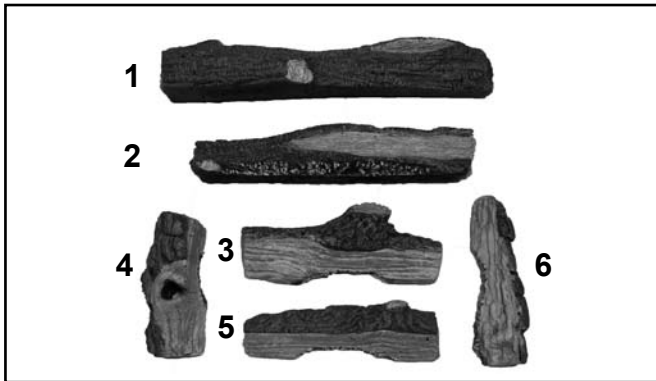

Log Identification

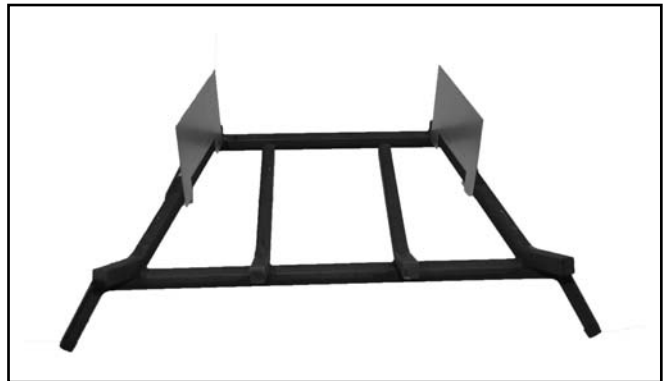

Back Log Stand-Offs in place

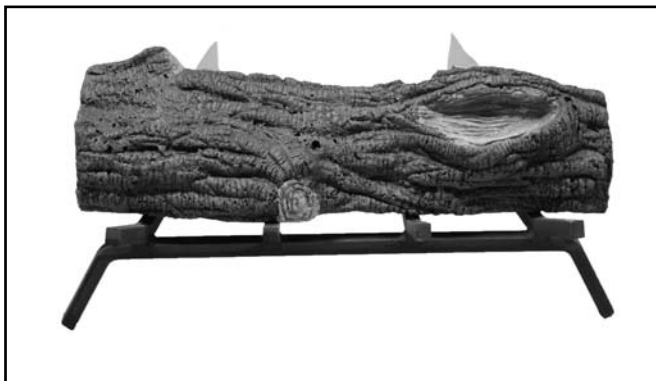

Place main front log (1) onto front area of the grate

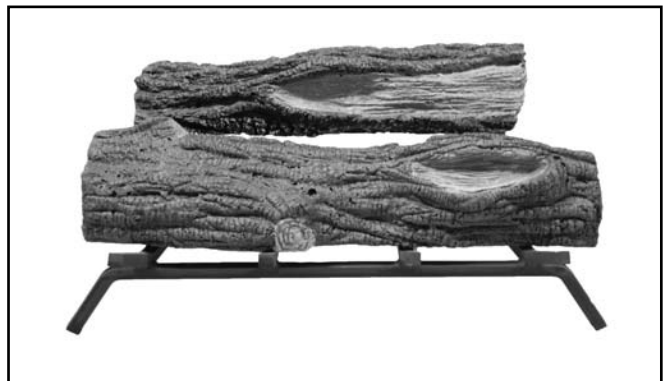

Place shorter back log (2) onto raised area of the grate

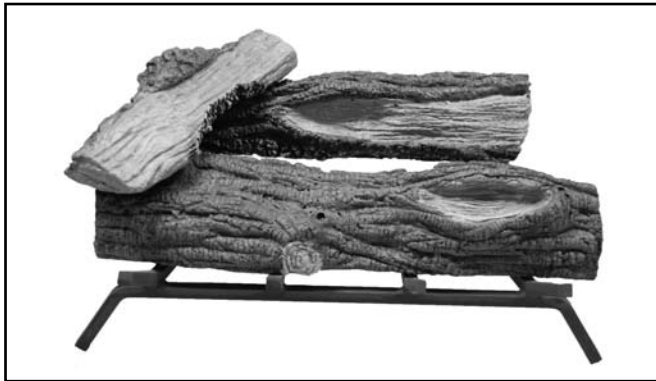

Place Cross-Log (3) at the left side



Place Cross-Log (4) at the right side



Place Cross-Log (5) at the center



Place Cross-Log (6) from the center to the right side

# LOG PLACEMENT

## MODEL: SH24NG

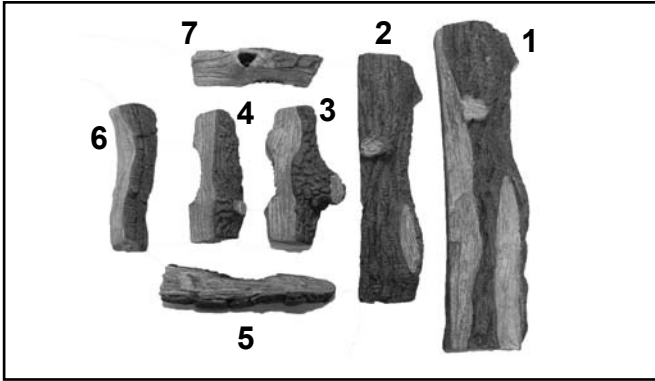

**Log Identification**

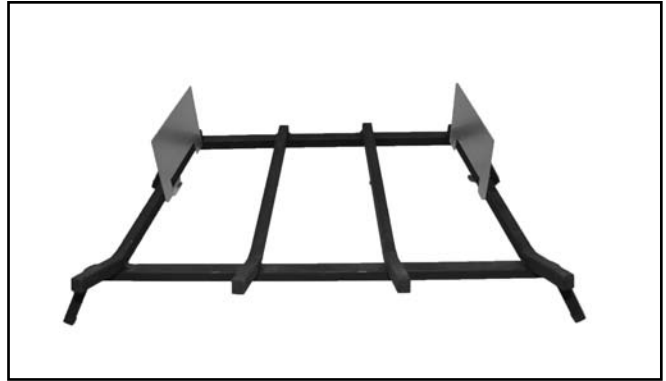

**Back Log Stand-Offs in place**



**Place main front log (1)  
onto front area of the grate**



**Place shorter back log (2)  
onto raised area of the grate**



**Place Cross-Log (3) at the left side**



**Place Cross-Log (4) at the center left**



**Place Cross-Log (5) at the center right**



**Place Cross-Log (6) at the right side**

# LOG PLACEMENT

## MODEL: SH24NG Continued



Place cross-log (7) atop cross-log (6) and to front center as shown

### MAINTENANCE

Very little maintenance is required. The carbon deposit resulting from combustion is natural and adds to the realistic appearance of the set. If carbon becomes excessive it can be lightly brushed or vacuumed away.

We recommend for the appliance and the fireplace flue to be professionally inspected and cleaned each year, prior to operation.

### VISUAL INSPECTION AND MONITORING OPERATION

Each time you operate the gas log set, pay attention to the flame pattern, and the amount of carbon (soot) being produced. If the gas log set continuously produces excessive carbon, you may wish to rearrange the stack of the logs to allow more free space for the flames.

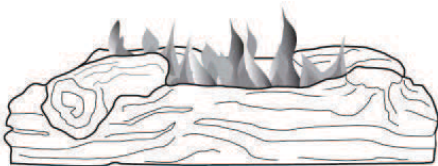

Figure 10 - Correct Burner Flame Pattern



Figure 11 - Incorrect Burner Flame Pattern (Excessive flame height, combined with extremely yellow flames producing carbon (soot)).

### TROUBLE SHOOTING

	<u>Problem</u>	<u>Cause</u>	<u>Corrective Action</u>
1.	No Ignition	-Valve not fully in "on" position -gas line obstruction	-turn valve to "on" position -inspect supply lines/ tube for kinks or obstructions
2.	Inadequate flame	-Valve partially closed -gas line partial obstruction  -log arrangement incorrect	-open valve fully -inspect burner tube for kinks or obstructions -rearrange logs to specified pattern

# LIMITED WARRANTY

**Warranty shall apply to the original purchaser at the original installation point only.**

All logs are guaranteed for three years against manufacturer's defects.

The burner assembly system is guaranteed for a period of (3) years from the date of purchase and will be replaced for freight costs only.

General Warranty: This warranty does not apply in the case of improper installation, neglect, accident, misuse or as a result of modifications of the original product.

All costs for removal and re-installation are the expressed responsibility of the purchaser.

For repair, replacement, or service to defective part(s) please contact our Customer Service Hotline, number below. Thereafter with valid warranty registration and proof of purchase, call the Customer Service Hotline for authorization to ship defective part prepaid and insured in original carton to Sure Heat Manufacturing, 3140 Moon Station Road, Kennesaw GA 30144. Goods returned improperly packaged are the sole responsibility of purchaser.

It is agreed that any repair or replacement is the exclusive remedy from Sure Heat Manufacturing. In no case shall Sure Heat be liable for any consequential damage or breach of this or any other warranty expressed or implied whatsoever. This limitation as to consequential damages shall not apply in states where prohibited.

Purchased From: \_\_\_\_\_ Date: \_\_\_\_\_

Size:  18"  24"  30"      Model:

Name: \_\_\_\_\_ Phone: \_\_\_\_\_

Address: \_\_\_\_\_

City: \_\_\_\_\_ State: \_\_\_\_\_ Zip: \_\_\_\_\_

***Please photocopy and return to SHM International within 14 days of purchase.***

**SHM International 3140 Moon Station Road, Kennesaw GA 30144**

If you have other questions, please contact the Customer Service Hotline - (800) 229-5647