



NaturoPure[™]

MULTI-TECHNOLOGY

HF 380 AIR PURIFIER



INSTRUCTION MANUAL

HEAVEN FRESH

©2010, HFFR-CANFR-HF 380-03/11

Thank you for purchasing the efficient Heaven Fresh HF 380 Air Purifier. We wish you many years of healthy indoor air with this innovative product.

SAFETY OPERATION

Ensure that all safety precautions are followed when using electrical appliances for the proper operation of the device.

This instruction booklet describes the safety precautions to be observed during operation to prevent injuries to yourself, other persons and damage to the device. The content not only is suitable for this product but also suitable for electrical appliances in general.

SPECIAL ATTENTION



AC 110~120V/50~60Hz. (North America)
AC 220~240V/50~60Hz. (Europe and Asia)
Over voltage may cause fire hazard or electric shock.



To prevent fire or electric shock hazard, do not place the unit in wet places where water may enter the device.



To prevent electric shock, do not dismantle, repair or modify this product freely. Maintenance and cleaning shall be processed as exactly as what instructed in this manual. In case of malfunction, please contact the authorized maintenance center.



Do not use fabrics or other materials to cover this device. Obstructed air inlets and outlets will result in abnormal operation of this device that may lead to fire or other accidents.



Do not use in places where flammable and explosive materials are stored.



To prevent interference and distortion, the device should be placed at least 1 meter away from the computer, television or radio.



Do not subject the device to direct sunlight or near high temperature objects. Internal temperature rise in serious cases may cause fire, in mild cases may cause deformation of the outer casing. (Stop operation when ambient temperature exceeds 104 °F (40° C))



For safety reasons and to prevent fire or electric shock, unplug the power cord from the electric outlet socket under the following conditions:

- When you do not use the device for a long period.
- When cleaning, servicing the machine or during replacement of filter materials.
- When you move the device.



Do not allow foreign objects into the device. High voltage inside the device may cause electric shock. Children should not be allowed to touch or play with this device to avoid accidents.

WARNING

If the power cord is damaged, it must be replaced by an authorized service personnel in order to avoid electric shocks and fire hazards.

COMPONENTS

[Front View]

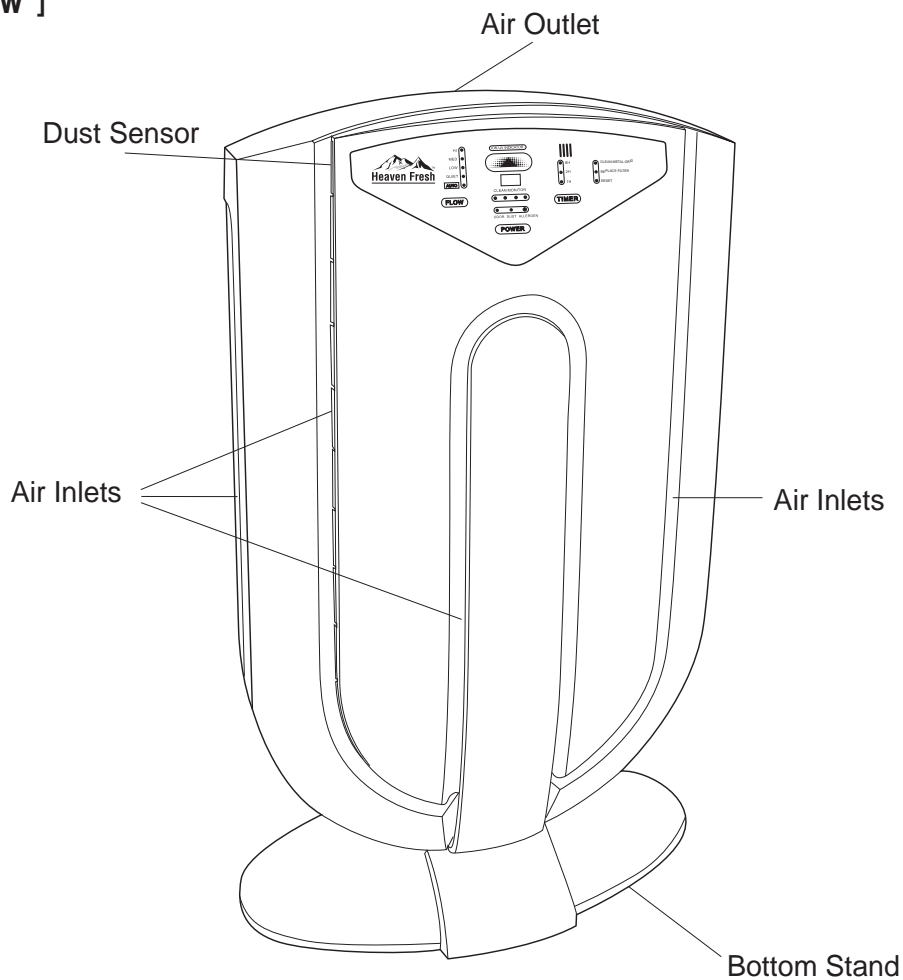

[Control Panel]

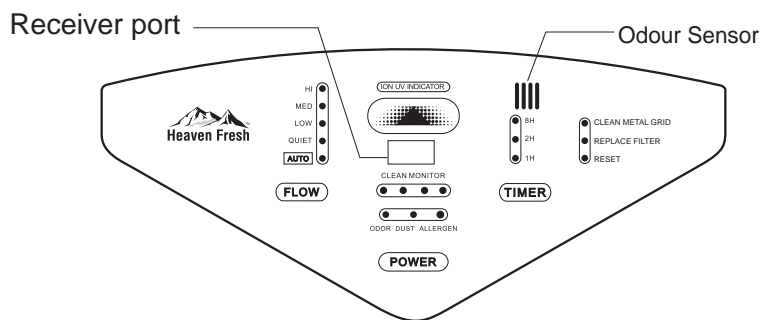

COMPONENTS

[Back View]

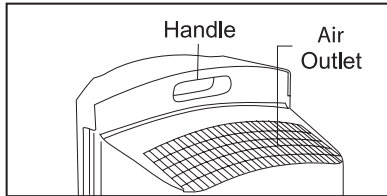

[Interior View]

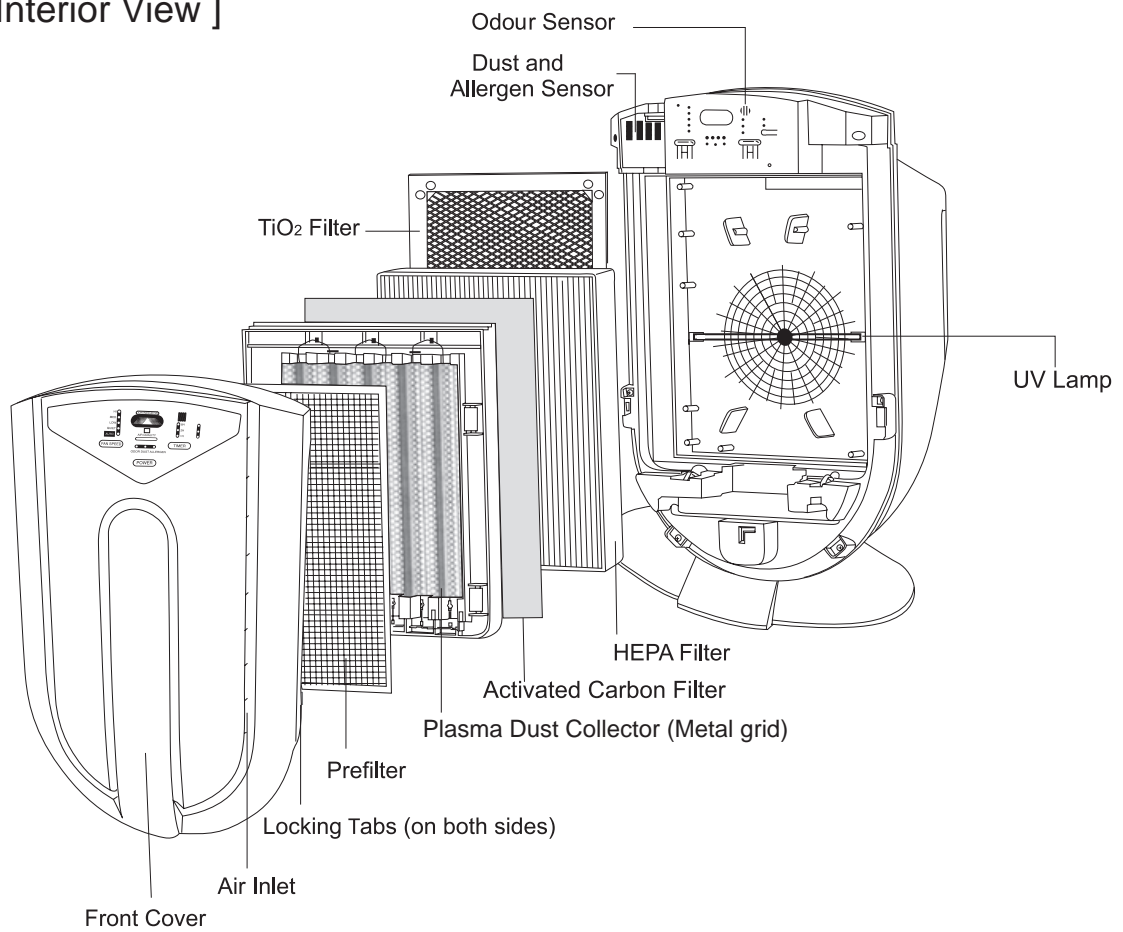

BEFORE USING

Follow these steps to optimize accuracy of clean air sensors:

Open Windows for Air Ventilation

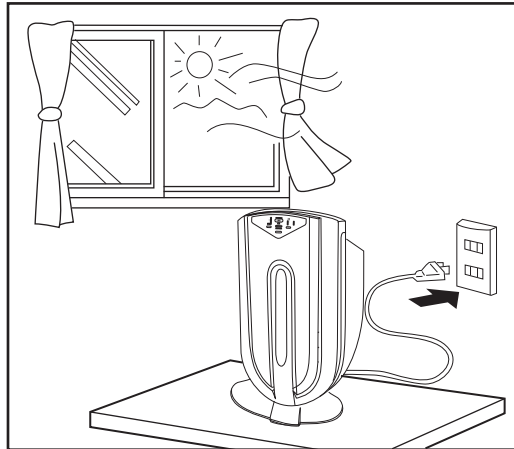

1. Run the unit for a couple hours or more.
2. During this time, also increase ventilation in the room as much as possible, even opening a window if the air outside is at least fairly clean.
3. Unplug the HF 380, then immediately plug it in, turn it on, and resume operation.

Unplugging the HF 380, then plugging it in again resets the clean air sensor's memory. By first ensuring the air is as clean as possible, and then immediately resetting, the sensor will be more accurate once you resume normal operation.

EXPLANATION OF INDICATORS

Negative Ion Indicator

- During the process when negative ions are generated, the blue indicator will gradually change from bright to dim and from dim back to bright every 5 seconds.

Odour Indicator

- The odour indicator will glow whenever the odour sensor detects odour (such as indoor smoke).

Dust and Irritant Indicator

- The dust-and-irritant indicator will glow whenever dust or other irritants are detected.

Air Quality Surveillance

- Whenever odour, dust, or irritants are detected, the air quality surveillance function will indicate the level of pollution. When pollution is severe, all LED will glow.

[Example]

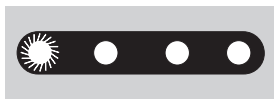

No pollution detected

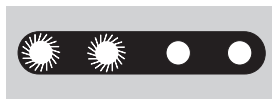

Some pollution detected

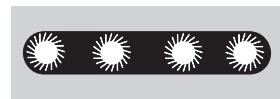

Severe pollution detected

OPERATING INSTRUCTIONS

※ Place the device at least 30cm (1 ft) from the wall and where children cannot touch within a short range of distance.

How to Start

- Plug into a proper socket. Press the POWER ON/OFF button. The device starts operating as the negative ion UV indicator is on. Press POWER ON/OFF again to turn off the device.

Fan Modes

- This device has five different fan modes to choose from. Please choose a proper level of circulation according to indoor air quality and room size. As you press FAN, the fan mode will change according to the number of times you press the button. The LED will show the following sequence of modes:

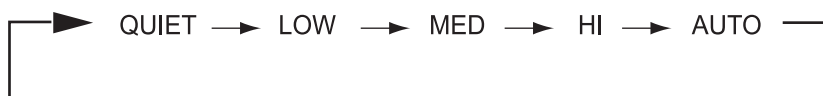

Automatic Operation

- Keep pressing the FAN button until the device runs under automatic operation (the LED will show AUTO).
- Under automatic operation, the device automatically switches to the proper running modes (MED or LOW) according to the level of odour, dust, or irritants in the air as detected by the sensor. As the air is purified, the device will automatically switch back to LOW or QUIET modes.

Timer ON/OFF

- Press AUTOTIMER button to set operation duration.
- Under the AUTOTIMER function, the operation duration will be set according to the number of times you press the AUTOTIMER button. The LED will show the following sequence of timing:

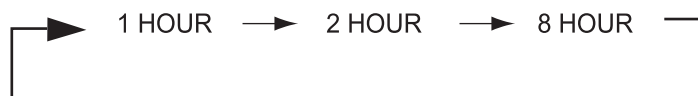

CLEANING AND MAINTENANCE

- ※ During cleaning and maintenance, please turn off and disconnect the plug from the power outlet.
- ※ Cleaning and maintenance every 2 to 3 months is recommended.

Disassembling the device

- Carefully lay down the device with the front facing up, open the device according to the following 5 steps (Assemble the device back together with the same steps but in the opposite sequence):

1. Open the front cover

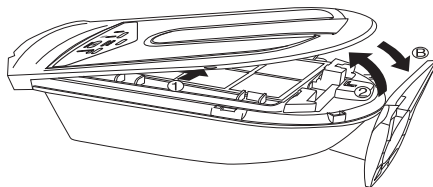

ⓐ Please attach firmly at the connecting locations

- ① Press the locking tabs on both sides of the device
- ② Gently lift up the front cover

When assembling

- ③ Firmly reconnect the front cover back to its original position
- ④ Make sure the two locking tabs are reattached properly

2. Removing the plasma dust collector

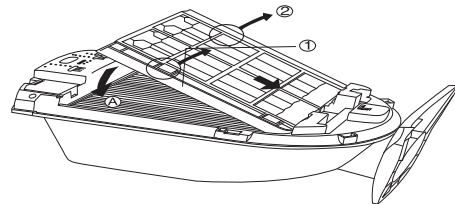

- ① Push the plasma dust collector towards the base of the device. Use your foot or knee if needed to hold the base in place.
- ② Push the two tabs inward and lift up the dust collector. Hold the top of the unit (where the control panel is) down to help pull out the collector grid.

When assembling

- ① Push the plasma dust collector towards the bottom of the device
- ② Insert into position A

3. Removing the front filter

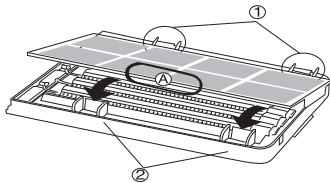

- ② Hold position A and lift up the front filter

When assembling

- ① Attach the filter to the connecting locations on the side
- ② Fasten the filter on the front connecting locations

4. Removing the high-performance filter

Do not reverse the front and back of the filter

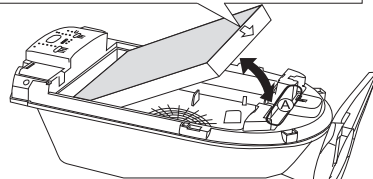

- ② Place your hand into position A and pull out the filter
- ※ When replacing filter, please ensure that the filter is installed correctly with the front-and-back direction as indicated on the sides of the filter. Do not reverse the front and back of the filter.

5. Removing the TiO₂ Filter

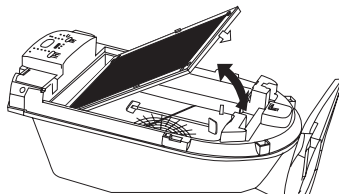

- ② Hold the clips of both sides to pull out the filter.

CLEANING AND MAINTENANCE

Dust sensor cover

- Use a dry cloth to remove all the dust from the sensor cover.

TiO₂ Filter

- Use a dry towel or air to blow away the dust.

Activated Carbon HEPA Filter

- Use a vacuum cleaner to eliminate dust on the filter.

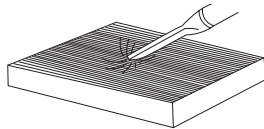

Prefilter

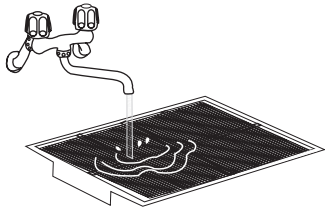

- Can be cleaned under flowing water.
- Do not clean with hot water.

Unit front cover

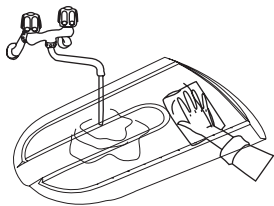

- Can be cleaned with running water.
- Please use a soft cloth to clean & avoid scratching the coating on the cover.
- Avoid cleaning with hot water or rubbing with excess force.

Please refer to page 8 for assembling and disassembling of the unit.

Plasma Dust Collector

(Refer to page 11 for cleaning)

Unit body

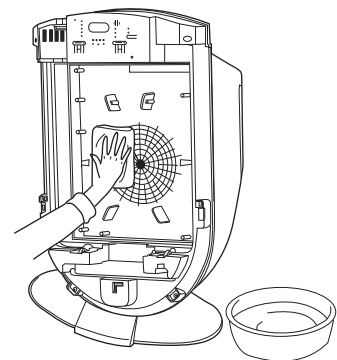

- Remove UV lamp before cleaning
- Use a slightly damp cloth to wipe & clean

UV light

CLEANING AND MAINTENANCE

Cleaning and maintenance of the plasma dust collector

Please clean and maintain when:

- The cleaning indicator is glowing or blinking.
- The dust collector is making sound of electrical discharge.
- The device has been used frequently in an area with lower air quality condition.

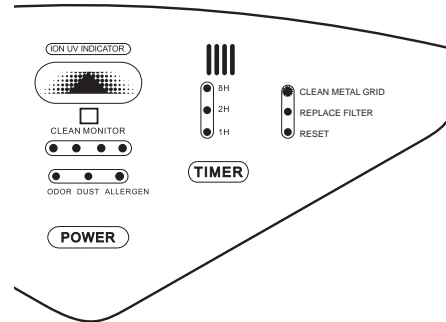

1. Remove the plasma dust collector and the front filter

Please refer to page 8 for the disassembling of front cover and the plasma dust collector.

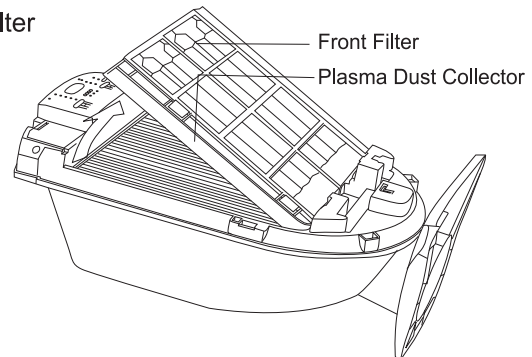

2. Lift up the tab at the top of the plastic housing for the metal dust collector grid. Once this tab is open, remove the dust collector. Please wear protective gloves to avoid any cuts on your fingers.

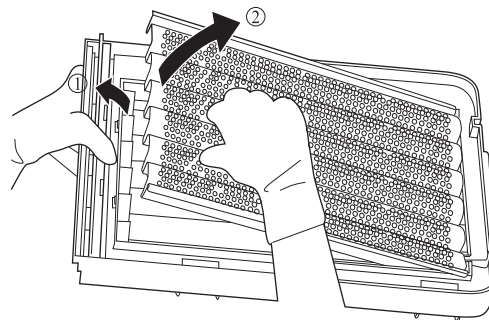

CAUTION

Please keep in mind that electrical wires of the Plasma Dust Collector Plate are fragile and special care is required while cleaning.

CLEANING AND MAINTENANCE

Cleaning and maintenance of the plasma dust collector

3. Clean the plasma dust collector

- use mild detergent
- use a scouring pad or toothbrush to clean the dust collector
- use warm water

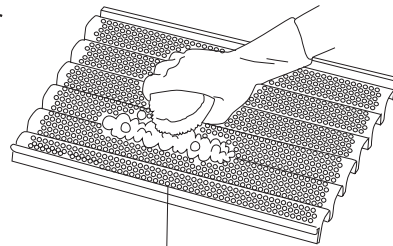

Plasma Dust Collector

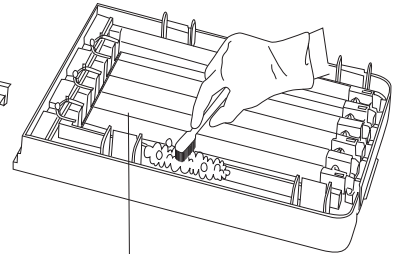

Electrical Discharge Wire

- If the dirt is hard to remove, pre-soak in diluted detergent and then use a toothbrush to clean.
- ※ **Please beware not to damage any wiring while cleaning the dust collector.**
If any electrical discharge wire is broken, the device will lose part of, or all of its dust collecting function
- ※ Any broken wire should be removed or discarded instead of being left inside the unit. Otherwise this would result in a short-circuit or high-voltage spark. Also, the circuit control of the device would be affected.
- ※ Please contact the distributor if you want to purchase additional electrical discharge wire
- ※ Please do not clean using acidic or alkaline detergent that can cause rusting on the surface of device

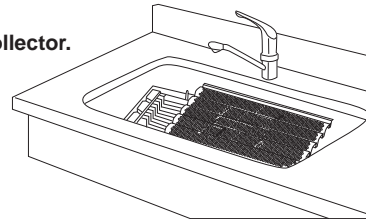

4. Thoroughly clean and dry

- ※ After cleaning, please ensure that the unit is completely dry before use. Otherwise, it could cause electrical shock or malfunction
- ※ If the front cover of the plasma dust collector is not properly installed, no electricity will be connected
- ※ Please make sure the plastic wrap for the electrical discharge wire is located at its proper position

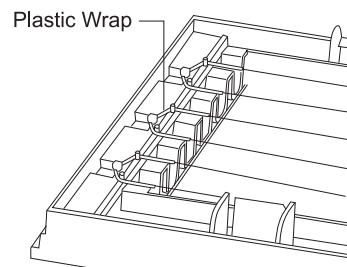

CLEANING AND MAINTENANCE

Replacing filters

- Please change filter when the FILTER REPLACE indicator is glowing.
- ※ Please refer to page 8 on how to replace filters.

Replacing the UV lamp

- The life span of the UV lamp is about 10,000 hours. Replace the UV lamp when it is not functioning, damaged or when no blue light is observed.
- Remove the front cover, plasma dust collector and filters before replacing the UV lamp.
- Carefully twist the UV lamp, remove the lamp tube from its position, and replace with a lamp tube of the same model.

Resetting

- After cleaning and replacing filters, reset the CLEAN METAL GRID and REPLACE FILTER indicators. Otherwise the two indicators would remaining glowing after turning on the unit.
- While resetting, the unit should remain plugged into the socket, **but the unit itself should be turned off.** The RESET button is inside the unit (cannot be reached with finger).
- Please use a toothpick or other sharp object to push the RESET button.

How to reset

1. CLEAN METAL GRID Indicator

- With the unit turned off, the resetting process for CLEAN METAL GRID indicator is done by pushing both the RESET and the TIMER buttons at the same time.

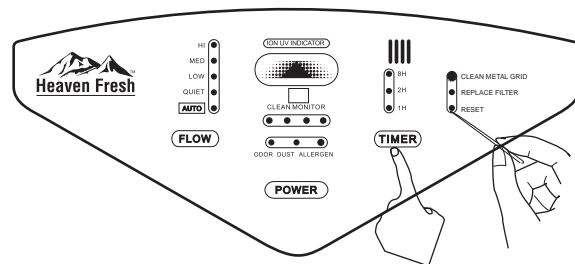

2. REPLACE FILTER Indicator

- With the unit turned off, the resetting process for REPLACE FILTER Indicator is done by pushing both the RESET and the FLOW buttons at the same time.

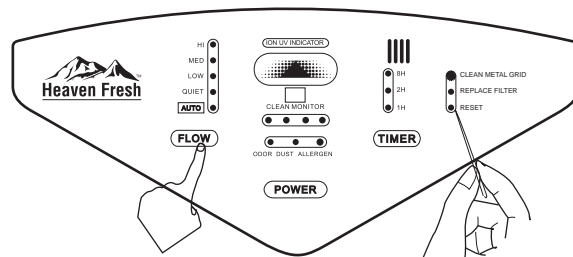

CLEANING AND MAINTENANCE

Cleaning and Maintenance of the Dust and Irritant Sensor

※ The dust sensor will need to be cleaned periodically. If the Dust and/or Allergen sensor continues to remain lit, then this may be a sign that the dust sensor requires cleaning. A dirty dust sensor may also prevent the unit from lowering to LOW or QUIET mode while it is on AUTOMATIC operation.

CLEANING STEPS

1. Remove the front cover and the dust sensor cover.



2. Take out the dust sensor and carefully unplug its connecting cord. Make note of how it is plugged in.



3. Unscrew the sensor cover using a small screwdriver. Remove the cover and sensor.

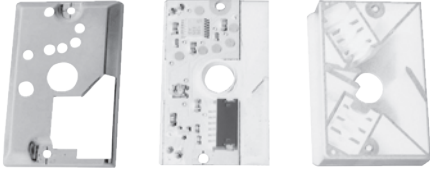
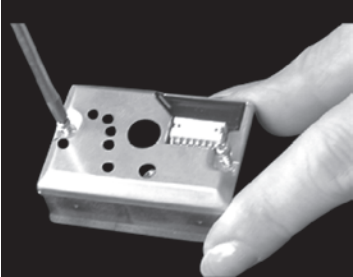

Cover Sensor Sensor box

4. Thoroughly clean the sensor (especially the emitter, receiver and the transparent part) and the sensor box.



Cleaning the sensor

Cleaning the sensor box

5. Put back the sensor correctly after cleaning, make sure that the cord is reconnected in the correct direction.

FREQUENTLY ASKED QUESTIONS

Clean Air Monitor

Q. Why does only one LED light glow under "Clean Air Monitor"?

A. First, the air may have been clean the whole time. Or, the air purifier may be positioned where the sensor is too far away from the airborne pollutants and irritants. If this is the case, relocate the unit where it is close to the source of indoor air pollution. To test the sensor, stir dust or increase pollution near the sensor. If the level of pollution goes up when this is done, then the sensor is operating properly.

Q. Why is there always two LED lights glowing under "Clean Air Monitor"?

A. There are multiple possibilities for this. One possibility is that polluted air from outside the room is being circulated into the room with the unit. Another possibility is that a constant amount of pollution is being created within the room, such as from smoking. It is also important to note that it can take some time to clean the room to the point where only one LED light is on, indicating the air around the unit is purified.

Q. Why does the "Clean Air Monitor" function keep switching back and forth?

A. The Irritant Sensor can be affected by a cell phone or other wireless equipment. Keep cell phones and other wireless equipment away from the unit.

Dust and Irritant Sensor

Q. Why does the Dust and Irritant Sensor keep blinking?

A. The top of the sensor has accumulated too much dust, and needs to be cleaned. Please refer to page 13 of this manual for instructions on cleaning the sensor.

Odour Sensor

Q. Why doesn't the Odour Sensor work?

A. The sensor memory needs to be reset. Refer to page 5 under Before Using. When first purchased or when the unit has been unplugged for over a week, the sensor will not be as sensitive. After 1 to 2 days of operation, the sensor will regain its sensitivity.

Filter

Q. Why is the filter not getting rid of dust and odour effectively?

- Have the front and back of the filter been mistakenly reversed?
- The filter is saturated with dust. Please replace filter.

FREQUENTLY ASKED QUESTIONS

Plasma Dust Collector

Q. Why is it so difficult to eliminate dust and odour?

- The electrical discharge wires or the plasma dust collector is too dirty.
Please refer to page 10 on how to clean and maintain.
- Check the electrical discharge wires to make sure they have not been disconnected or broken. If they are, please fix or contact the distributor for a replacement.

Cannot turn on the unit

Q. Why is the unit not working even after turning it on?

- Is it firmly plugged into the wall socket? Please check to make sure it is.
- Has the unit been properly reassembled after being cleaned? Please confirm.
The unit will not operate if the plasma dust collector or the front cover is not properly installed.

APPLICABLE AREAS

- ※ The unit is applicable for any room with a size of 650 ft² (60.4 m²). It can be used in the bedroom, living room, office, hotel, hospital etc.
- ※ If the unit is to be used in a smaller room, you may prefer to have the setting on medium or low.

TECHNICAL SPECIFICATIONS

Model: NatruroPure™ HF 380

Rated Voltage: AC 110~120V/50~60Hz. (North America)
AC 220~240V/50~60Hz. (Europe and Asia)

Power consumption: 80 W (High Setting)

Ion output: > 4,000,000 / cm³

UV: 20uw (254 Nanometers)

Dust Removal Rate: 99.97%

Noise Level (dB): Silent (20) Low (35) Med (45) High (52)

Air Volume: 106 ft³ (3.0 m³) per Minute (High Setting)

Dimensions: 13.5" (L) x 10.0" (W) x 24.0" (H)
34.3 (L) x 25.4 (W) x 61.0 (H) (cm)

Weight: 15 lbs (6.8 kg)

Coverage Area: 650 ft² (60.4 m²)

WARRANTY CERTIFICATE

WARRANTY CERTIFICATE FOR THE MULTI-FUNCTIONAL PURIFICATION SYSTEM HF 380

Date of purchase: _____

Customers name: _____

Address: _____

Telephone: _____

Email: _____

Seller's name: _____

Address: _____

1. Please fill in completely this Warranty Certificate. Send it with the invoice and the unit, postage pre-paid and using the original packing box, to your distributor. Make sure to include the appropriate return postage for the package.
2. Please enclose a short description of the damage, fault or malfunction, and the circumstances under which these problems arose.



WARRANTY INFORMATION

Heaven Fresh products are subject to strict quality control before leaving the manufacturer. This allows our customers to benefit from repairs, replacement of parts and even replacements for free.

- What is covered:** All parts defective in material and workmanship.
For how long: Three years from purchase date.
What we will do: Repair or replace any defective parts.
Exclusions: Regular replacement parts such as air filter cartridges and UV lamp.

90-Day Replacement Policy

If, due to manufacturer defect, any part requires repair during the first 90 days after receiving your item, Heaven Fresh will replace it with a new item.

What You Must Do

1. Contact Heaven Fresh customer support at:



1-866-625-1857
www.heavenfresh.ca



1-800-642-0367
www.heavenfresh.com



0800 952 9962
www.heavenfresh.co.uk

for Return Authorization Number.

2. Pack the product in its original carton, and in the same manner in which you received it, or as identical as possible.
3. Include proof of purchase inside box along with the Return Authorization Number.
4. Label and ship the unit, freight pre-paid, to the address provided.

Other Conditions

The provisions of this warranty are in lieu of any other written warranty whether express or implied, written or oral, including any warranty of merchantability or fitness for a particular purpose. The manufacturer's maximum liability shall not exceed the actual purchase price paid by you for the product. In no event shall the manufacturer be liable for special, incidental, consequential, or indirect damages. This warranty does not cover a defect that has resulted from improper or unreasonable use or maintenance, faulty assembly, accident, natural catastrophes, improper packing, or unauthorized tampering, alteration, or modification as determined solely by us. This warranty is void if the label bearing the serial number has been removed or defaced.

**Canada**

sales@heavenfresh.ca
www.heavenfresh.ca
1-866-625-1857 (English)
1-866-583-1857 (French)

USA

sales@heavenfresh.com
www.heavenfresh.com
1-800-642-0367

UK

sales@heavenfresh.co.uk
www.heavenfresh.co.uk
0800 952 9962

Germany

sales@heavenfresh.de
www.heavenfresh.de
0800 66 47 259

France

sales@heavenfresh.fr
www.heavenfresh.fr
0800 900 991

Ireland

sales@heavenfresh.ie
www.heavenfresh.ie
1-800-550-457

Middle East

sales@heavenfresh.ae
www.heavenfresh.ae
+971 (06) 557 3640