

# NV51K6650DS

5.1 cu. ft. Double Wall Oven

## Cabinet Dimensions

Double Oven Installed in Cabinet

\*Junction Box

\*\*Allow a minimum of 22" for clearance to adjacent corners, drawers, walls, etc. when door is open.

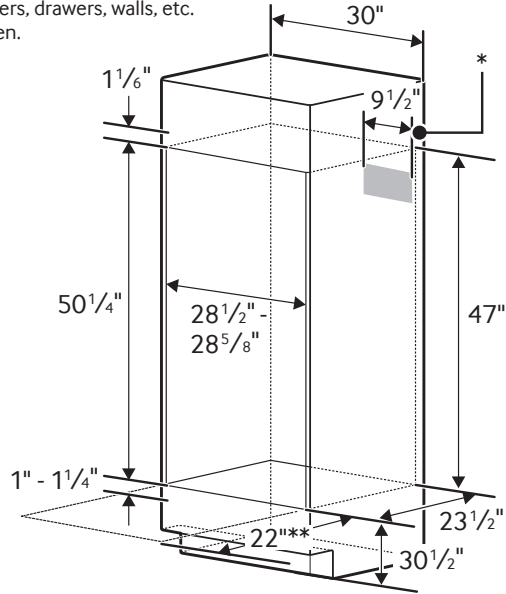

## Product Dimensions

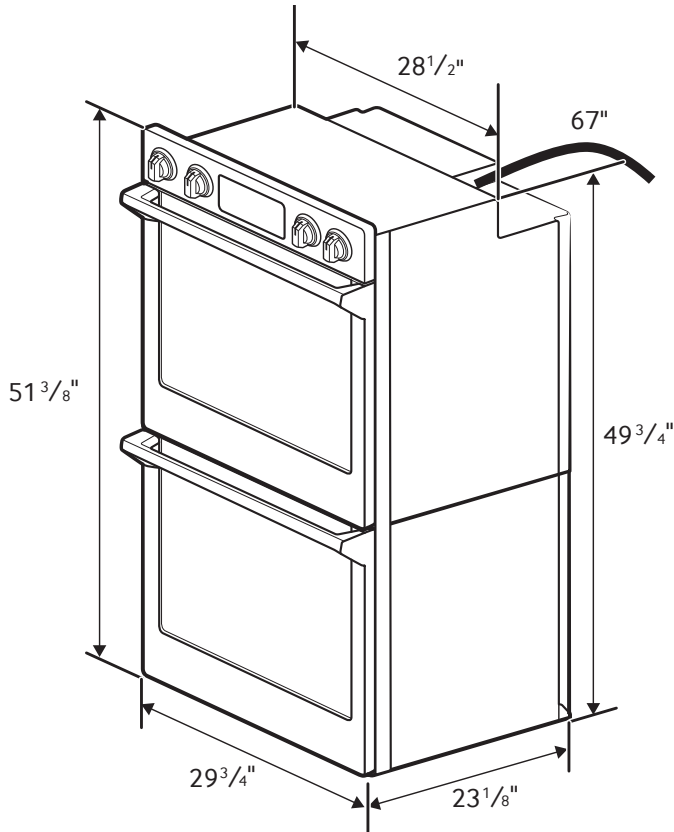

## Total Capacity: 5.1 cu. ft.

Upper Oven: 2.8 cu. ft. / Lower Oven: 2.2 cu. ft.

- Hidden Bake Element
- Bake: 175°F–550°F
- Convection Bake: 175°F–550°F
- Convection Roast: 175°F–550°F
- Broil: Low-High
- Steam Bake: 230°F–550°F
- Steam Roast: 230°F–550°F
- Proofing
- Sabbath Mode

## Warranty

One (1) Year All Parts and Labor

## Product Dimensions & Weight (WxHxD)

Outside (Max) Cooktop Dimensions:

28<sup>3</sup>/<sub>4</sub>" x 51<sup>3</sup>/<sub>8</sub>" x 24<sup>7</sup>/<sub>16</sub>"

Wall Oven Cut-Out Dimensions:

28<sup>1</sup>/<sub>2</sub>" x 50<sup>1</sup>/<sub>4</sub>" x 23<sup>1</sup>/<sub>2</sub>"

Weight: 260.1 lbs.

## Shipping Dimensions & Weight (WxHxD)

Dimensions:

33<sup>1</sup>/<sub>2</sub>" x 56<sup>3</sup>/<sub>8</sub>" x 29<sup>13</sup>/<sub>16</sub>"

Weight: 288.8 lbs.

## Color

Stainless Steel

Black Stainless Steel

## Model #

NV51K6650DS

NV51K6650DG

## UPC Code

887276184005

887276183992

KW RATING	
240V	9.3
208V	7.0
BREAKER SIZE	
240V	40 Amps
208V	40 Amps

**SAMSUNG**

Actual color may vary. Design, specifications, and color availability are subject to change without notice. Non-metric weights and measurements are approximate.

©2016 Samsung Electronics America, Inc. 85 Challenger Road, Ridgefield Park, NJ 07660. Tel: 800-SAMSUNG. samsung.com. Samsung is a registered trademark of Samsung Electronics Co., Ltd.