

nuwave[®]
— LIVE WELL FOR LESS —

**RECIPES
INCLUDED!**

NuWave[®] Brio Healthy Digital 6Q Air Fryer



Owner's Manual

nuwave®

LIVE WELL FOR LESS

BRIO™ AIR FRYER



NuWave Oven Pro Plus



NuWave Brio™ Air Fryer

Super-heated air cooks your food to crispy, tender perfection. The digital touch screen gives you precise temperature control.

NuWave Electric Skillet

Coated with Duralon® Healthy Ceramic Non-Stick for easy cleanup. Includes a premium tempered glass lid.

NuWave Oven Pro Plus

Cook healthier meals faster and more efficiently with Triple Combo Cooking Power.

More about our innovative products, visit:

NUTRI-POT™ 6Q
Pressure Cooker



NuWave Electric Skillet



NuWave PIC



NuWave PIC

(Precision Induction Cooktop)

Cook faster, safer and more efficiently than you ever could on your gas or electric stovetop.

NuWave Nutri-Pot™ 6Q Pressure Cooker

Easily cook rice, poultry, vegetables, and more all with the press of a button! The Nutri-Pot's safety release valve and hinged lid make for convenient and safe operation.

www.NuWaveNow.com

 1-877-689-2838

Flavor Lockers™ with Vacuum-Seal Technology



NuWave Flavor-Lockers™ with Vacuum-Seal Technology

Keep food fresh for 21 days! Remove the oxygen with a few easy pumps. Slow the growth of mold by removing trapped oxygen.

NuWave Nutri-Master™ Slow Juicer

The Nutri-Master™ with a low 48 RPM is incredibly quiet and powerful enough to extract juice from nut and hard vegetables.

More about our innovative products, visit:

Nutri-Master™ Slow Juicer

**Duralon® Healthy Ceramic
Non-Stick Cookware**



NuWave Duralon® Healthy Ceramic Non-Stick Cookware



Coated with Duralon® Healthy Ceramic Non-Stick for easy cleanup, this versatile cookware is perfect for use in the oven as well as on gas, electric, and even induction cooktops.

www.NuWaveNow.com

 **1-877-689-2838**

GUIDE

The following guide indicates the amount of time, temperature, and weight for the various food types that are listed below.

Food Type	Shake/ Flip	Time (min)	Temp (°F)	Suggested Amount	Additional Notes
Frozen French Toast Sticks	Flip	8-10	380	8 oz	/
Frozen Hash Brown Patties	Flip	18-25	360	1-4 patties	/
Cinnamon Rolls	/	10-12	350	1-5 rolls	Cover w/foil ½ way
Thin Frozen Fries	Shake	8-14	400	28 oz	/
 Thick Frozen Fries	Shake	14-17	400	24 oz	Medium-thick cut
 Homemade Fries	Shake	20-25	360	12-16 oz	Soak in water - 30 minutes
Homemade Potato Wedges	Shake	20-25	360	12-16 oz	Soak in water - 30 minutes
Homemade Potato Cubes	Shake	15-20	360	12-16 oz	Soak in water - 30 minutes
 Steak (½" ribeye)	Flip	12-18	360	1-4 (8 oz each)	/
Pork Chops (with bone)	Flip	15-20	375	1-3 (8-12 oz each)	/
Frozen Hamburgers	Flip	16-20	360	1-2 (5 oz each)	/
Fresh Hamburgers	Flip	12-16	360	1-4 (8 oz each)	/
Italian Sausage	Flip	13-15	400	3-7 (4 oz each)	/
Chicken Wings	Shake	20-25	390	24 oz	/
 Poultry	Flip	11-14	360	1-2 (8 oz each)	Chicken Breast
Spiral Ham	/	9-10 min/lb	300	Up to 5 lbs	Cover with foil
Boneless Ham	/	11-13 min/lb	300	Up to 7 lbs	Cover with foil
Whole Chicken	Flip	10-12 min/lb	375	Up to 6 lbs	Cover with foil
Frozen Tater Tots	Shake	6-8	360	16-20 oz	/
Spring Rolls	Shake	6-8	360	16 oz	/
 Chicken Nuggets	Shake	8-12	390	12 oz	/
 Fish	Shake	6-10	400	12 oz	Frozen Fish Sticks
Stuffed Poppers	Shake	8-10	360	12 oz	/
Onion Rings	Shake	12-16	360	16 oz	/
Breaded Mushrooms	Shake	8-10	390	12 oz	/
Mozz. Sticks/Zucchini	Shake	5-7	360	16 oz	/

Note: Actual cooking times may vary depending on the size and shape of the ingredients used. Listed cooking times should be used as a guide. Adjust the settings as necessary to suit your needs. According to the FDA, the safe internal temperature is 165°F for poultry and 160°F for pork.

TABLE OF CONTENTS

Guide	6	Grilled Ham and Cheese.....	38
Important Safeguards	8	Tortilla Crusted Tilapia.....	39
Save These Instructions	9	Salmon with Orange Curry Sauce.....	40
Parts Description	10	Turkey Sliders	41
Operating Instructions	11-19	Apple Glazed Pork Tenderloin.....	42
Care & Maintenance	19	Citrus Green Beans.....	43
Troubleshooting Guide	20-21	Crispy Tofu	44
Warranty	22	Bacon Wrapped Onion Rings.....	45
Recipes		Party Meatballs	46
Twice Baked Potato	25	Pasta Bake	47
Roasted Brussel Sprouts	25	Philly Cheese Steak Braid.....	48
Home Fries.....	26	Cheesy Rice Stuffed Meatloaf.....	49
Air Baked Eggs	27	Santa Fe Bell Pepper	50
Air Fried Tortilla Chips	28	Kale Chips.....	51
Classic Bacon Cheeseburger.....	29	Roasted Tomatoes	52
Buffalo Wings	30	Roasted Root Vegetables	53
Spinach Stuffed Chicken.....	31	Apple Pie.....	54
Chicken Satay.....	32	Banana and Nutella Wontons.....	55
Grilled Chicken Tenders.....	33	Pineapple Crescents.....	56
Parmesan Chicken Tenders	34	Apple Pie Egg Rolls	57
Butter-Infused Chicken.....	35	Berry Cheesecake Egg Rolls	58
Cajun Shrimp	36	Easy Blueberry Muffins	59
Chimichurri Skirt Steak.....	37		



nuwave[®]
— LIVE WELL FOR LESS —
www.NuWaveNow.com

IMPORTANT SAFEGUARDS

READ ALL INSTRUCTIONS

When using electrical units, basic safety precautions should always be followed including the following:

1. Do not touch hot surfaces.
2. To protect against electrical shock, do not immerse cord, plugs, or the unit in water or other liquid.
3. Close supervision is necessary when any unit is used by or near children.
4. Unplug from outlet when not in use and before cleaning. Allow to cool before putting on or taking off parts.
5. The use of other accessories that are not intended to be use with this unit is not recommended. Doing so may damage the unit and can cause accidents.
6. NOT INTENDED FOR OUTDOOR USE.
7. Do not let cord hang over edge of table or counter, or touch hot surface.
8. Do not place on or near a hot gas, electric burner and or in a heated oven.
9. Extreme caution must be used when moving unit containing hot oil or other hot liquids.
10. To disconnect, turn any control "OFF", then remove plug from the wall outlet.
11. Never put the appliance against the wall or other appliances. There should be at least 3 inches of free space for the back side. Left/right sides and the upper side of the appliance. Do not place anything on top of appliance.
12. During air frying, hot steam is released from the air outlet opening. Keep your hands and face distance from the steam and from the air outlet opening. Also, be careful of hot steam and air when you remove the Fry Pan Basket from the appliance.
13. Make sure the ingredients prepared in this appliance come out golden yellow instead of dark or brown. Remove burnt remnants.

	! WARNING
	Please immediately cut off circuit and send unit to our Customer Service Department in case of other problems. 1-877-689-2838 • help@nuwavenow.com

DO NOT USE THE UNIT FOR OTHER THAN INTENDED USE.

Note: Put the appliance on a surface that is horizontal, even and stable. This appliance is intended normal household use. It is not intended to be used in environments such as staff kitchen of shops, offices, farms or other work environments. Nor is it intended to be used by clients in hotels, motels, bed and breakfast and other residential environments.

SAVE THESE INSTRUCTIONS

1. Do not place the unit close to flammable materials heating units or wet environments.
2. Height of ingredients placed in the Fry Pan Basket should comply with the directions listed under “Operation Instructions”.
3. Do not replace with other parts that are not designed specifically for the NuWave Digital Brio 6-Qt Digital Air Fryer.
4. Do not put any other cooking pans in the Fry Pan Basket. Do not replace any parts with other containers.
5. If a lot of smoke is escaping from the air vent during operation, unplug the unit immediately and contact customer service.*
6. Do not move the unit while in operation. Only after the NuWave Digital Brio 6-Qt Digital Air Fryer has completely cooled down should you attempt to move it. Always wait for the NuWave Brio Healthy Digital 6-Qt. Air Fryer to cool down prior to handling it.
7. Never use a towel to block the vent.
8. If any troubles arise during operation, any necessary service must be done by NuWave, LLC or authorized by the manufacturer for repairs.
9. Do not disassemble the unit on your own or replace any parts.
10. Do not use metal utensils with the coated Fry Pan Basket as this can damage the surface.
11. If the power cord is damaged, do not attempt to operate the unit.*
12. Keep the unit out of reach of children when the unit is operating or cooling down.
13. Keep hands and face away from the venting outlet or where heat or steam is being released.
14. Make sure NuWave Brio Healthy Digital 6-Qt. Air Fryer is always clean prior to cooking.
15. It is normal for some smoke to escape the unit when heating for the first time.

***Customer Service Department at 1-877-689-2838 • help@nuwavenow.com**

	⚠ CAUTION
	<ul style="list-style-type: none">• Always put the ingredients to be fried in the Fry Pan Basket to prevent direct contact with the heating components.• Do not cover the air inlet and outlet opening while the appliance is operating.• Do not pour oil into the Base Tray, this may create a fire hazard.• Never touch the inside of the appliance while it is operating.

PARTS DESCRIPTION

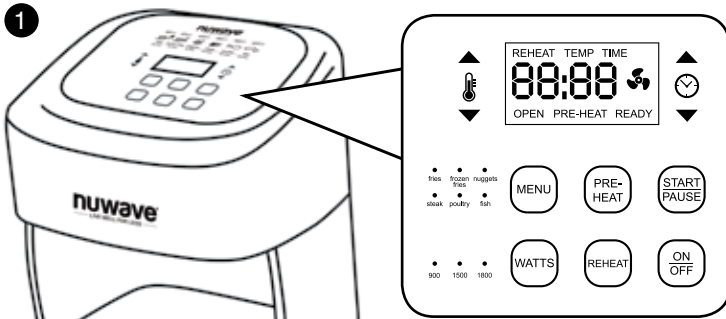

1. Air Fryer Power Base

Part #: 37206

2. Fry Pan Basket

Part #: 37202

3a. Fry Pan Divider

Part #: 37205

3b. 4 Silicone Tabs

Part #: 37207

4. Base Tray

Part #: 37201

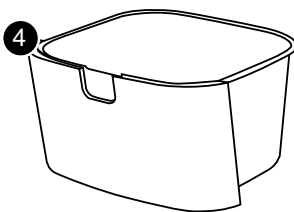
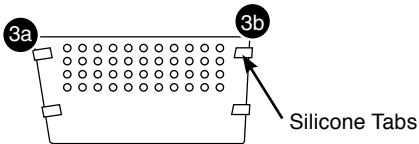
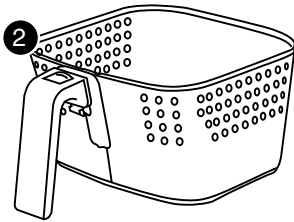

OPERATING INSTRUCTIONS

Before Use:

1. Remove all the packaging materials.
2. Remove the glue and labels on the appliance.
3. Clean the Fry Pan Basket, Base Tray, thoroughly with hot water, a nonabrasive sponge and a mild dish detergent, or in the dishwasher, top rack only.
4. Wipe the inside and outside of the appliance with a wet cloth. Do not immerse the appliance in water.

Note: This appliance cooks using hot air. DO NOT fill the basket with oil.

Operation Preparation:

1. Place the appliance on a level, even, and stable heat-resistant surface.
2. Place the Base Tray and Fry Pan Basket in the NuWave Brio Healthy Digital 6-Qt. Air Fryer.
3. Plug the appliance into a standard wall socket. The power plug is included in the package.

Note: Do not cover or block the vent located on the back of the NuWave Brio Healthy Digital 6-Qt. Air Fryer. Doing so can prevent proper ventilation and will adversely affect the cooking results.



Operation Functions - On/Off Function:

Press “On/Off” button once to turn the unit on. The control panel should display “0” indicating that no cooking time or temperature has been selected and the unit is powered on. Press “On/Off” button again to turn the unit off.

Wattage Function:

The default wattage of the NuWave Brio Healthy Digital 6-Qt. Air Fryer is 1800 watts. To change the wattage, press “Watts” once. The red light will illuminate above “900” indicating that the NuWave Brio Healthy Digital 6-Qt. Air Fryer is now set to 900 watts. Press “Watts” once more and the red light above “1500” will illuminate, indicating the NuWave Brio Healthy Digital 6-Qt. Air Fryer is now set to 1500 watts. Press “Watts” again and the red light above “1800” will illuminate, indicating that the NuWave Brio Healthy Digital 6-Qt. Air Fryer is now set to the default 1800 watts.

If you change the wattage from the default 1800W to either 900W or 1500W and unplug the unit, the NuWave Brio will remember the last wattage setting when you plug it back in.

OPERATING INSTRUCTIONS

**START
PAUSE**







Easy Start/Pause Function:

- Press “Start/Pause” button once to begin cooking, “:15” will be displayed as well as a fan icon, and the NuWave Brio Healthy Digital 6-Qt. Air Fryer will start to countdown. The default is 360°F for 15 minutes.
- To interrupt the cooking process, press the “Start/Pause” button again.
- To resume cooking or preheating, press the “Start/Pause” button again.

MENU

Menu Selection:

Press "Menu", the red light above fries will illuminate and "360" will be displayed. Press "Start/Pause" to begin cooking, the countdown will begin. To choose a different food from below, before you press "Start/Pause", simply press "Menu" to select the food. See chart below for pre-programmed "Menu" selections. To get out of the menu selection, press menu again until the red light above the food type is no longer lit. If using the Pre-Heat function, press "Pre-Heat" before "Menu" to ensure proper temperature. All menu selections default to 1800 watts.

Food Type	Time (minutes)	Temp	Food Amount (ounces)
 Fries (Homemade Thick cut)	25	360°F	8-12
 Frozen Fries (Medium cut)	15	400°F	28
 Chicken Nuggets	8	400°F	12
 Steak (½" ribeye)	12	360°F	8 oz each
 Poultry (Chicken breast)	12	360°F	8 oz each
 Fish (Frozen Fish Sticks)	8	400°F	12

PRE-HEAT

“Pre-Heat” Function:

The “Pre-Heat” function ensures that the NuWave Brio Healthy Digital 6-Qt. Air Fryer reaches the desired temperature before you begin cooking your food. The “Pre-Heat” function is the perfect choice for foods that require a crispier finish, such as frozen appetizers, French fries, or chicken wings. Press the “Pre-Heat” button. The control panel will display “0” and “Pre-Heat”.

OPERATING INSTRUCTIONS (Continued)



Pressing "Start/Pause" will default to 360°F for 15 minutes, 360 will be flashing along with the fan icon. If needed, manually adjust the cooking temperature and time, then press "Start/Pause". Once you press "Start", the desired temperature will be flashing and "Pre-Heat" will be displayed.

Once the NuWave Brio Healthy Digital 6-Qt. Air Fryer reaches the set temperature, the control panel will display "Ready" and the NuWave Brio Healthy Digital 6-Qt. Air Fryer will beep once. The NuWave Brio Healthy Digital 6-Qt. Air Fryer will start a countdown of 5 minutes and the number "5" will start flashing. It will remain at this temperature for up to 5 minutes, or until you remove the Fry Pan Basket, whichever comes first.

Once the food has been added to the Fry Pan Basket, insert the Fry Pan Basket back in place. This will start the countdown on the set cooking time.

Note: If you remove the Fry Pan Basket at any point during the preheating stage, the NuWave Brio Healthy Digital 6-Qt. Air Fryer will automatically pause, start a countdown of 5 minutes until you replace the Fry Pan Basket. Once the NuWave Brio Healthy Digital 6-Qt. Air Fryer shows "ready" on the display, open the basket and place back in to start the countdown timer. If you cook another batch of food shortly after cooking in the NuWave Brio Healthy Digital 6-Qt. Air Fryer, you do not need to use the "Pre-Heat" Function as the NuWave Brio Healthy Digital 6-Qt. Air Fryer will already be hot. If you wish to cook your food longer, simply place the Base Tray and Fry Pan Basket back into the appliance and continue cooking in 2-3 minute increments until desired consistency has been reached.



Adjusting Temperature:

The NuWave Brio Healthy Digital 6-Qt. Air Fryer is set to cook at 360°F by default. To set a different cooking temperature, press the arrows above and below Temp icon. The display will show "360F". "Temp" will be flashing. To adjust the temperature, continue to press the "Up" and "Down" arrows. You can adjust your temperature in 5-degree increments between 100°F and 400°F.

OPERATING INSTRUCTIONS (Continued)



To quickly adjust the temperature in large increments, simply **hold down** the “Up” or “Down” arrow to adjust the temperature by 50-degree increments. You can change the cooking temperature at any point during the cooking process. Press the arrows above and below the Temp icon. Programed temperature will be displayed. “Temp” will be flashing. Press the “Up” or “Down” arrow until you reach your desired temperature.

Once your temperature has been selected, the NuWave Brio Healthy Digital 6-Qt. Air Fryer will automatically adjust to the new temperature and the display will show the remaining cooking time. If no new temperature has been selected within 3 seconds, the NuWave Brio Digital Air Fryer display will once again show the remaining cooking time.



Adjusting Time:

The NuWave Brio Healthy Digital 6-Qt. Air Fryer is set to cook for 15 minutes by default. To set a different cooking time, press the up and down arrows above and below the Time icon. The display will show “15”. “Time” will be flashing. To adjust the time, continue to press the “Up” and “Down” arrows. You can adjust your cooking time in 1 minute increments.

To quickly adjust the time in large increments, simply **hold down** the “Up” or “Down” arrow to adjust the time by 10-minute increments, followed by 20-minute increments, followed by 30-minute increments. The minimum selectable cooking time is 1 minute. The maximum selectable cooking time differs depending on the selected cooking temperature.

- 100°F – 345°F maximum cooking time is 16 hours
- 350°F – 400°F maximum cooking time is 1 hour

OPERATING INSTRUCTIONS (Continued)

You can change the cooking time at any point during the cooking process. Press the up and down arrows above and below the Time icon. The remaining cooking time will be displayed. Press the “Up” or “Down” arrow until you reach your desired cooking time. Once your cooking time has been selected, the display will show the new remaining cooking time.

Note: After timer reaches 1 minute, the display will begin showing the remaining time in seconds (59, 58, etc.).



Reheat Function:

The default setting is programmed at 360°F at 1800 Watts for 4 minutes. This function is perfect for reheating single portion-sized foods. Press the Reheat button, this will activate the default setting. For example if you are warming leftover pizza, simply place the slice in the basket, and in an oven-safe container (glass, metal, Silicone). For softer rice or noodles, add a sprinkle of water and cover with foil.

OPERATING INSTRUCTIONS (Continued)

For Best Results

After you have selected your cooking time and temperature and you are ready to add your ingredients to the NuWave Brio Healthy Digital 6-Qt. Air Fryer: Pull out the Base Tray and Fry Pan Basket from the NuWave Brio Healthy Digital 6-Qt. Air Fryer. (Fig. 1)

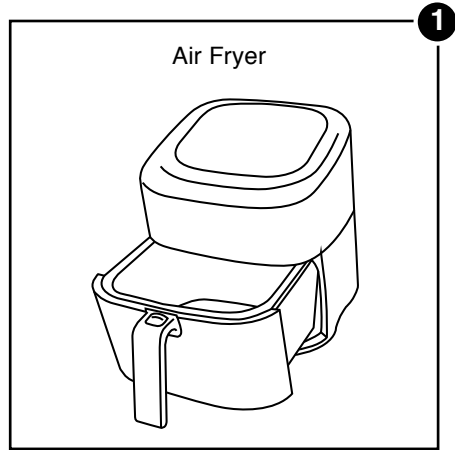

Note: Do not fill more than $\frac{4}{5}$ full. Slip the Fry Pan Basket in place in the NuWave Brio Healthy Digital 6-Qt. Air Fryer. Do not use the Base Tray without the Fry Pan Basket in it. (Fig. 2.) Do not touch the inside of the Base Tray immediately after cooking as the pan can become very hot. Only hold the pan by the handle.

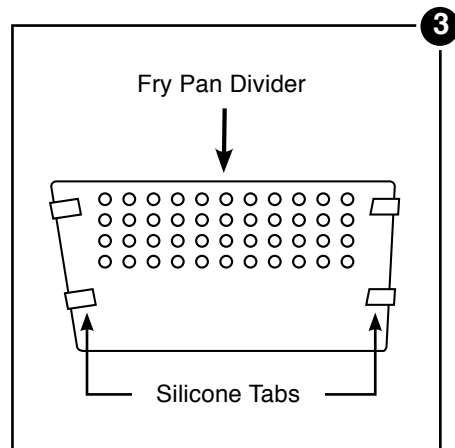
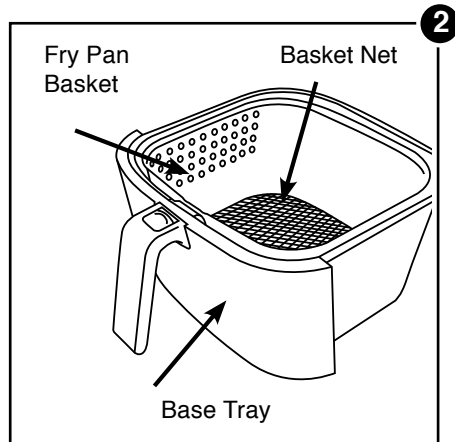

OPERATING INSTRUCTIONS (Continued)

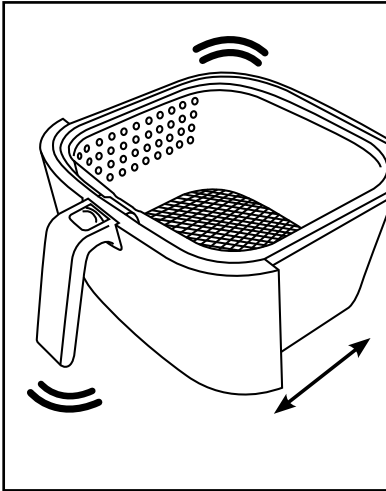

Shaking Food:

Some foods require shaking halfway through cooking. To properly shake the food, hold the handle, remove the Base Tray from the appliance, and shake. Once the food has been adequately shaken, slide the Base Tray and Fry Pan Basket back into the NuWave Digital Brio 6-Qt Digital Air Fryer.

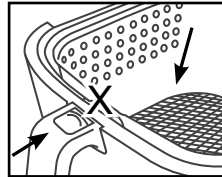

DO NOT PUSH THE DEMOUNTING BUTTON FORWARD WHILE SHAKING.

Silicone Tabs

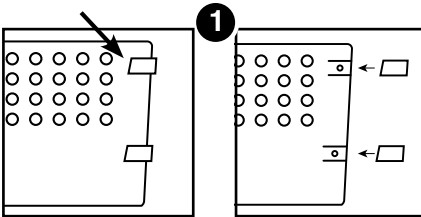

Using the Fry Pan Divider:

Fig. 1.

Make sure all 4 Silicone tabs are placed on the divider tabs.

Fig. 2.

Looking down at the basket, slide the divider down the center of the basket. Make sure the divider is between both the groves and screws of the basket.

To remove divider, simply slide the divider straight up.

You can remove the Silicone tabs from the divider for cleaning.

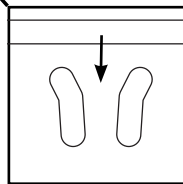
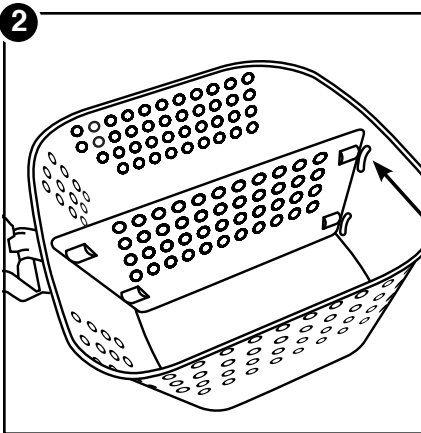

OPERATING INSTRUCTIONS (Continued)

Removing the Fry Pan Basket:

To remove the Fry Pan Basket from the Base Tray.

1. Push the demounting button forward.

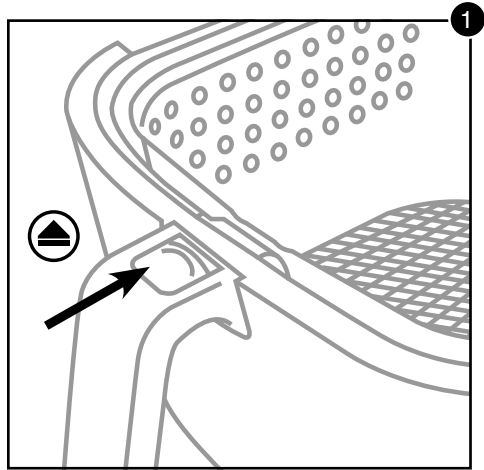

2. Lift the Fry Pan Basket of the Base Tray.

This will reduce the extra weight of the Base Tray and makes it easier to pour smaller foods, such as French fries.

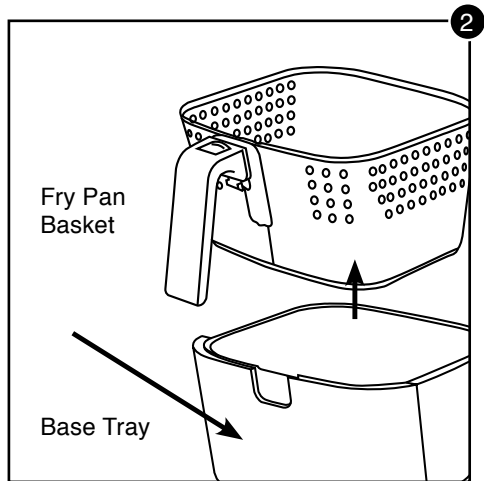

- Unplug the appliance and make sure it cools completely.

Note: Remove the Base Tray and Fry Pan Basket, place on a heat resistant surface to help cool the appliance quicker.

- Use a damp cloth to wipe the outside of the appliance.
- **The Fry Pan Divider can be removed from the Fry Pan Basket to make clean up easier.** Clean the Fry Pan Basket, Divider and inside components with a nonabrasive sponge, hot water and mild detergent.

Note: If using the dishwasher for the Base Tray, Divider and Fry Pan Basket it is recommended to use top rack only.

OPERATING INSTRUCTIONS (Continued)

Tip: If there is residual food in the Base Tray, Divider and Fry Pan Basket, add some hot water and let it soak separately for about 10 minutes for easier cleaning.

- Clean the inside of the appliance with a nonabrasive sponge and hot water.
- Once cooled completely, clean the Fry Pan Basket, Divider and Base Tray with a soft cleaning brush to remove any lingering food.

Storage:

- Unplug the appliance and let it cool down completely.
- Make sure that all the parts are cleaned and dry.
- Push the power cord into the storing capsule. Fix the cord by inserting it into the cord fixing unit.

IMPORTANT - Do not immerse unit in water or attempt to cycle through dishwasher. The outer surface may be cleaned by wiping carefully with a damp dishcloth or sponge. Make sure unit has cooled completely prior to cleaning.



CARE & MAINTENANCE

Cleaning:

Clean the appliance after every use or in between a large amount of batches. The Fry Pan Basket and the Base Tray have a non-stick coating with a stainless steel Basket Net. Do not use metal utensils or harsh abrasives when cleaning as this can damage the coating.

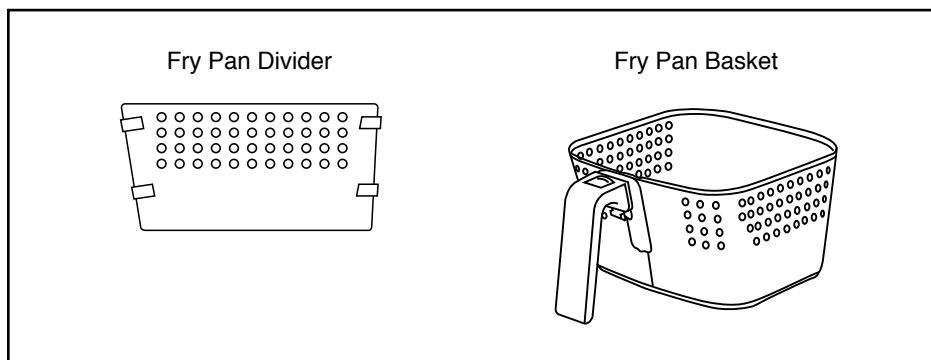

TROUBLESHOOTING GUIDE

PROBLEM	POSSIBLE CAUSE(S)	RESOLUTION(S)
The NuWave Brio Healthy Digital 6-Qt. Air Fryer does not work.	The appliance is not plugged in. Did not press On/OFF button. Fry Pan Basket is not in the NuWave Brio Healthy Digital 6-Qt. Air Fryer.	Insert the plug into an appropriate grounded power socket. Press ON/OFF button after settings are selected. Place the Fry Pan Basket in the NuWave Brio Healthy Digital 6-Qt. Air Fryer.
The ingredients fried in the Fry Pan Basket are not completely cooked.	Too many ingredients were used. The cooking temperature is too low. The cooking time is too short.	Remove some ingredients from the Fry Pan Basket. Smaller batches are fried more evenly. Fry at a higher temperature. Set the NuWave Brio Healthy Digital 6-Qt. Air Fryer to fry for a longer time.
The food is fried unevenly.	Certain types of ingredients need to be shaken halfway through the preparation time.	Ingredients that are on the top need to be shaken halfway through the preparation time.
Fried snacks are not crispy when they come out of the NuWave Brio Healthy Digital 6-Qt. Air Fryer.	You used a type of snack meant to be prepared in a traditional deep fryer.	Use snacks designed to be baked in a traditional oven, or lightly brush some olive oil onto the snacks for a crispier result.
I cannot slide the Fry Pan Basket into the appliance properly.	The Fry Pan Basket is overfilled. The Fry Pan Basket is not placed in the Base Tray correctly.	Do not fill the Fry Pan Basket more than 4/5. Push the Fry Pan Basket down into the Base Tray until you hear a click.
White smoke is coming out of the product.	You are frying greasy foods. The pan contains greasy residue from previous uses.	When you are preparing greasy ingredients in the NuWave Brio Healthy Digital 6-Qt. Air Fryer, large amounts of oil can smoke and infiltrate into the pan. The oil will produce white smoke and the frying pan might become hotter than usual. This will not affect the final cooking effect. White smoke is caused by greasy heating up in the pan. Make sure you clean the frying pan properly after each use.

TROUBLESHOOTING GUIDE

PROBLEM	POSSIBLE CAUSE(S)	RESOLUTION(S)
French fries are fried unevenly in the NuWave Brio Healthy Digital 6-Qt. Air Fryer.	You did not soak the potato sticks properly before you fried them. You did not use the right potato type.	Soak potato sticks in a bowl of water for at least 30 minutes, take them out and dry them with paper towel. Use fresh potatoes and make sure they stay firm during frying.
French fries are not crispy when they come out of the NuWave Brio Healthy Digital 6-Qt. Air Fryer.	The crispiness of the fries depends on the amount of oil and water in the fries.	Make sure you dry the potato sticks properly before you add the oil. Cut the potato sticks smaller for a crispier result. Add slightly more oil for a crispier result.
If the unit needs to be replaced or returned to the manufacturer, please contact our Customer Service Department at: 1-877-689-2838 help@nuwavenow.com		

Contact customer service if any of these errors occur			
Code	E1	E2	E3
Error	Sensor open ended	Sensor short circuit	Over heat

WARRANTY

The NuWave Brio Healthy Digital 6-Qt. Air Fryer

THE MANUFACTURER WARRANTIES

The NuWave Brio Healthy Digital 6-Qt. Air Fryer, including the Base Tray, Fry Pan Divider, and Fry Pan Basket, are to be free from manufacturer defects.

All electrical components are warranted for 1 year from the date of purchase, under normal household use, and when operated in accordance with the Manufacturer's written instructions. The Manufacturer will provide the necessary parts and labor to repair any part of the NuWave Brio Healthy Digital 6-Qt. Air Fryer at NuWave, LLC Service Department. After the expiration of the warranty, the cost of the labor and parts will be the responsibility of the owner.

THE WARRANTY DOES NOT COVER

The Limited Warranty is voided if repairs are made by an unauthorized dealer or the serial number data plate is removed or defaced. Normal deterioration of finish due to use or exposure is not covered by this Warranty. This Limited Warranty does not cover failure, damages or inadequate performance due to accident, acts of God (such as lightning), fluctuations in electric power, alterations, abuse, misuse, misapplications, corrosive type atmospheres, improper installation, failure to operate in accordance with the Manufacturer's written instructions, abnormal use or commercial use. NuWave, LLC reserves the right to void the Limited Warranty, where allowable by law, for products purchased from an unauthorized dealer.

TO OBTAIN SERVICE

The owner shall have the obligation and responsibility to: Pay for all services and parts not covered by the warranty; Prepay the freight to and from Service Department for any part or system returned under this warranty; Carefully package the product using adequate padding material to prevent damage in transit. The original container is ideal for this purpose. Include in the package the owner's name, address, day time telephone number, a detailed description of the problem, and your "**RGa number.**" (**Call 1-877-689-2838**) or e-mail **help@nuwavenow.com** to obtain the **RGa number** (Return Goods Authorization number). Provide the cooking system model & serial number and proof of date of purchase (a copy of the receipt) when making claims under this warranty.

MANUFACTURER'S OBLIGATION

The Manufacturer's obligation under this Limited Warranty is limited, to the extent allowable by law, to repairing or replacing any part covered by this Limited Warranty which upon examination is found to be defective under normal use. The Limited Warranty is applicable only within the continental United States and only to the original purchaser of the manufacturer's authorized channels of distribution. **THE LIMITED WARRANTY MAY NOT BE ALTERED, VARIED OR EXTENDED EXCEPT BY A WRITTEN INSTRUMENT EXECUTED BY THE MANUFACTURER. THE REMEDY OF REPAIR OR REPLACEMENT AS PROVIDED UNDER THIS LIMITED WARRANTY IS EXCLUSIVE. IN NO EVENT SHALL THE MANUFACTURER BE LIABLE FOR ANY CONSEQUENTIAL OR INCIDENTAL DAMAGES TO ANY PERSON, WHETHER OR NOT OCCASIONED BY NEGLIGENCE OF THE MANUFACTURER, INCLUDING WITHOUT LIMITATION, DAMAGES FOR LOSS OF USE, COSTS OF SUBSTITUTION, PROPERTY DAMAGE, OR OTHER MONEY LOSS.**

Some states do not allow the exclusion or limitation of incidental or consequential damages, so the above limitation exclusions may not apply. This Limited Warranty gives specific legal rights, and there may also be other rights which vary from state to state. **EXCEPT AS OTHERWISE EXPRESSLY PROVIDED ABOVE, THE MANUFACTURER MAKES NO WARRANTIES EXPRESSED OR IMPLIED ARISING BY LAW OR OTHERWISE, INCLUDING WITHOUT LIMITATION, THE IMPLIED WARRANTIES OF MERCHANTABILITY AND FITNESS FOR A PARTICULAR PURPOSE TO ANY OTHER PERSON. READ YOUR OWNER'S MANUAL. IF YOU STILL HAVE ANY QUESTIONS ABOUT OPERATION OR WARRANTY OF THE PRODUCT, PLEASE CONTACT NUWAVE, LLC.**

READ YOUR OWNER'S MANUAL: If you still have any questions about operation or warranty of the product, please contact **NuWave, LLC** at: **1-877-689-2838** or e-mail **help@nuwavenow.com**.

nuwave
— LIVE WELL. FOR LESS —

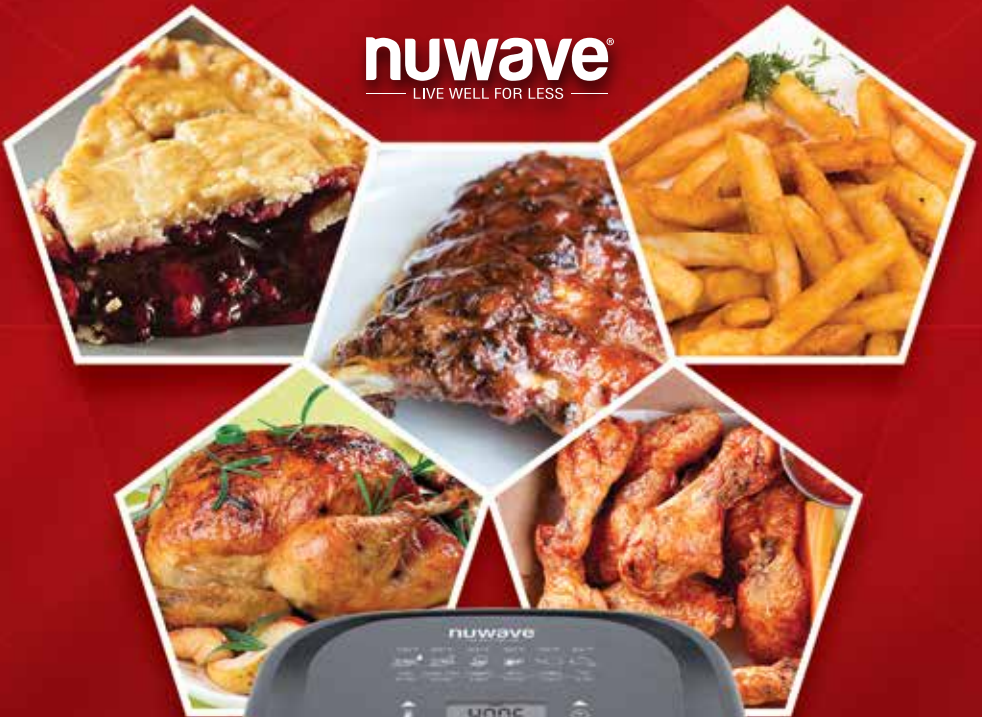

HEALTHY RECIPES



Twice Baked Potatoes (Serves 2)

Time and Temp:

Prep Time: 10 minutes

Cook Time: 43-50 minutes

Temp: 390°F + 350°F

Ingredients:

2 russet potatoes

½ cup of sour cream, plus extra for garnish

½ cup of chopped broccoli

5 slices of chopped bacon, cooked

1 tablespoon of salt

1 tablespoon of black pepper

1 tablespoon of butter

¾ cup of milk

¾ cup sharp cheddar cheese, shredded

2 tablespoons of chopped chives

Directions:

1. Place potatoes in NuWave Brio Basket and bake at 390°F for 35-40 minutes, or until soft in the middle.
2. Once fully baked, remove potatoes from NuWave Brio and let cool.
3. While potatoes are baking, combine sour cream, broccoli, bacon, salt, pepper, butter, and milk in medium bowl; set aside.
4. When potatoes are cool to the touch, cut potatoes in half and scoop out insides.
5. Add removed potato to sour cream mixture and stir to combine.
6. Place potato mixture back in skins and place in NuWave Brio Basket.
7. Bake potatoes at 350°F for 8-10 minutes.
8. Let potatoes cool for about 3-5 minutes, then transfer to serving tray and top with sour cream, cheese and chives.



Roasted Brussels Sprouts (Serves 4)

Time and Temp:

Prep Time: 10 minutes

Cook Time: 15 minutes

Temp: 390°F

Ingredients:

1 pound fresh brussels sprouts

2 teaspoons olive oil

½ teaspoon kosher salt

½ teaspoon black pepper

½ teaspoon granulated garlic

Directions:

1. Remove any tough or bruised outer Brussels sprouts leaves.
2. Trim the stems on the sprouts.
3. Rinse sprouts, shake dry, and set aside.
4. Press “Pre-Heat”, set temperature at 390°F and set cooking time at 15 minutes. Press “Start”.
5. Combine salt, pepper, garlic, and olive oil in bowl.
6. Add sprouts to bowl and toss to coat.
7. Once ready, place sprouts in Fry Pan Basket and cook, pausing occasionally to shake.

Tip: The sprouts are done when the centers are tender and the outsides are caramelized and a bit crispy. If the Brussels sprouts are large, cut in half vertically to ensure proper cooking.



Home Fries (Serves 6)

Time and Temp:

Prep Time: 40 minutes

Cook Time: 15 minutes

Temp: 390°F

Ingredients:

6 medium russet potatoes

2 tablespoons oil

½ tablespoon granulated garlic

1½ teaspoons paprika

½ teaspoon black pepper

½ teaspoon salt

Directions:

1. Boil potatoes in salted water for 40 minutes or until fork tender. Cool completely.
2. Add oil, garlic, paprika, pepper, and salt in mixing bowl and mix to combine.
3. Cut cooled potatoes into quarters and lightly toss in the mixture of oil and spices.
4. Press “Pre-Heat”, set temperature at 390°F and set cooking time at 14-16 minutes. Press “Start”.
5. Once ready, add the potato wedges to Fry Pan Basket skin side down, being careful not to overcrowd.
6. Cook wedges until golden brown.



Air Baked Eggs (Serves 3)

Time and Temp:

Prep Time: 10 minutes

Cook Time: 7-10 minutes

Temp: 300°F

Ingredients:

3 ramekins

6 ounces diced ham

3 large eggs

3-6 spinach leaves (optional)

3 teaspoons milk, divided

non-stick cooking spray or butter

salt and pepper to taste

Directions:

1. Press "Pre-Heat", set temperature at 300°F and set cooking time at 7-10 minutes. Press "Start".
2. Spray ramekins with non-stick spray.
3. Add spinach, ham, 1 egg, 1 teaspoon milk, salt, and pepper to each ramekin.
4. Once ready, place ramekins in Fry Pan Basket and cook.



Air Fried Tortilla Chips (Serves 4)

Time and Temp:

Prep: 5 minutes

Cook: 4 minutes

Temp: 390°F

Ingredients:

8 corn tortillas

1 teaspoon olive oil

salt to taste

Directions:

1. Press “Pre-Heat”, set temperature at 390°F and set cooking time for 4 minutes. Press “Start”.
2. Brush tortillas with olive oil.
3. Cut tortillas into triangles.
4. Once ready, place in Fry Pan Basket and cook.
5. Season with salt and enjoy.

Tip: Serve with your favorite salsa or guacamole.



Classic Bacon Cheeseburger (Serves 4)

Time and Temp:

Prep Time: 5 minutes

Cook Time: 16-18 minutes

Temp: 360°F

Ingredients:

1 ½ lbs of ground beef

8 slices of cooked bacon, cooked

1 egg

2 tablespoons of Worchester sauce

½ cup of fresh chopped onions

2 tablespoons of hamburger seasonings

4 slices of cheese

4 slices of tomatoes

4 leaves of lettuce

4 hamburger buns

Directions:

1. Place ground beef in a mixing bowl, add chopped onions, Worchester sauce, egg, and hamburger seasonings.
2. Form 4 hamburgers patties.
3. Place patties in air fryer basket and cook for 360°F for 16 minutes, flipping ½ way through.
4. Once patties are finished place to the side on a plate.
5. Place hamburger buns on a serving tray put patty between buns add cheese, tomatoes, and, bacon, and lettuce your choice of spread.



Buffalo Wings (Serves 4)

Time and Temp:

Prep Time: 10 minutes

Cook Time: 25 minutes

Temp: 390°F

Ingredients:

2 pounds chicken wings
(tips removed and wings cut into
drumettes and flats)

½ teaspoon salt

½ teaspoon pepper

½ teaspoon granulated garlic

¼ cup your favorite wing sauce

Directions:

1. Press “Pre-Heat”, set temperature at 360°F and set cooking time at 25 minutes. Press “Start”.
2. Combine salt, pepper, garlic, and oil in bowl and mix well.
3. Add wings to bowl and toss until fully coated.
4. Once ready, place half of the chicken wings in the Fry Pan Basket, and cook. Shake the Fry Pan Basket to ensure that the wings are evenly cooked.
5. Transfer cooked wings to large bowl and toss with 2 tablespoons wing sauce.
6. Repeat steps 4-5 with remaining wings and sauce.



Spinach Stuffed Chicken (Serves 2)

Time and Temp:

Prep Time: 15 minutes

Cook Time: 31-35 minutes

Temp: 360°F

Ingredients:

2 (1-pound) boneless, skinless chicken breasts

2 cups breadcrumbs

1 tablespoon butter, melted

1 tablespoon olive oil

¼ cup chopped red pepper (optional)

¼ cup chopped yellow pepper (optional)

¼ cup chopped onion

2 cups fresh spinach

1 tablespoon salt

1 tablespoon pepper

½ cup mozzarella cheese, shredded

Toothpicks

Directions:

1. Place chicken on cutting board and slice through one side making a pocket; set aside.
2. Add breadcrumbs and butter to bowl and stir to combine; set aside.
3. Add oil, peppers, onion, salt, and pepper to fry pan and sauté on medium heat for 3-5 minutes.
4. Add spinach and continue to cook until wilted.
5. Add breadcrumb mixture and cheese to pan and stir to combine.
6. Stuff spinach mixture into prepared chicken pockets and secure with toothpicks
7. Place chicken in NuWave Brio Basket and cook at 360°F for 31-35 minutes.

Tip: If chicken begins to brown too quickly, simply cover with foil.



Chicken Satay (Serves 4)

Time and Temp:

Prep Time: 15 minutes

Cook Time: 6-8 minutes

Temp: 390°F

Ingredients:

1 pound boneless chicken thighs

½ cup soy sauce

½ cup pineapple juice

¼ cup sesame oil

4 garlic cloves, chopped fine

4 scallions, chopped

1 tablespoon grated ginger

2 teaspoons toasted sesame seeds

1 pinch black pepper

Directions:

1. Cut each thigh into strips, trim excess fat.
2. Combine all the other ingredients into a large mixing bowl and mix well.
3. Place chicken onto skewers.
4. Add skewered chicken to mixing bowl and spoon marinade onto chicken to coat all sides.
5. Cover and refrigerate chicken for at least 2 hours, up to 24 hours.
6. Press “Pre-Heat”, set temperature at 390°F and set cooking time at 6-8 minutes. Press “Start”.
7. Once ready, place skewers in the Fry Pan Basket and cook.
8. Repeat steps 6-7 with remaining skewers.

Tip: If using wooden skewers, soak the skewers in water before adding chicken to keep them from burning.



Grilled Chicken Tenders (Serves 3)

Time and Temp:

Prep Time: 5 minutes

Cook Time: 15 minutes

Temp: 390°F

Ingredients:

½ pound boneless chicken tenderloins

¼ cup creamy caesar dressing

1 tablespoon olive oil

dash garlic powder

½ teaspoon dried basil leaves

1 teaspoon dried minced onion

dash pepper

Directions:

1. Rinse chicken and pat dry.
2. Combine chicken with all remaining ingredients in bowl or food storage bag.
3. Seal or cover chicken and refrigerate for 1-2 hours.
4. Press “Pre-Heat”, set temperature at 390°F and set cooking time at 15 minutes. Press “Start”.
5. Once ready, place chicken in Fry Pan Basket, and cook, halfway through to flip the tenders to ensure they are evenly cooked.



Parmesan Chicken Tenders (Serves 4)

Time and Temp:

Prep Time: 10 minutes

Cook Time: 8-12 minutes

Temp: 330°F

Ingredients:

non-stick cooking spray

¼ cup all-purpose flour

2 large eggs

½ cup finely shredded parmesan cheese

1 cup coarse dry breadcrumbs

1 pound chicken tenders

1 tablespoon Italian seasoning

1 teaspoon garlic powder

¼ teaspoon salt

Directions:

1. Press “Pre-Heat”, set temperature at 330°F and set cooking time at 8-12 minutes. Press “Start”.
2. Place flour in shallow dish.
3. Lightly beat eggs in separate shallow dish.
4. Combine Parmesan and breadcrumbs in separate shallow dish.
5. In medium bowl, toss chicken tenders in Italian seasoning, garlic powder, and salt.
6. Coat each chicken tender in flour, shaking off any excess.
7. Dip tender in egg and let any excess drip off.
8. Roll tender in breadcrumb mixture.
9. Once ready, spray Fry Pan Basket with non-stick cooking spray and place half of the tenders in the Fry Pan Basket. Set remaining half aside for later.
10. Generously coat tops of each tender with non-stick cooking spray.
11. Halfway through carefully turn each tender and top with more cooking spray.
12. Ensure the remaining cooking time is at least 4 minutes, and cook until outside is crisp and tenders are cooked through.
13. Repeat steps 9-12 with remaining tenders.



Butter-Infused Chicken (Serves 6-8)

Time and Temp:

Prep Time: 15 minutes

Cook Time: 10-12 minutes a pound

Temp: 375°F

Chicken Ingredients:

1 (3-5 pound) whole chicken

4 tablespoons seasoning salt

3 tablespoons black pepper

Butter Paste Ingredients:

1 stick of butter

4 teaspoons garlic powder

2 tablespoons dry oregano seasoning

1 onion, sliced

1 Green pepper, sliced (seeds and membrane removed)

Directions:

1. In a small mixing bowl, combine butter, oregano, and garlic powder; set aside.
2. Press Pre-Heat, set temperature at 375°F and set cooking time for 10-12 minutes a pound, then press Start.
3. Lightly separate the skin from the meat of the chicken without tearing the skin.
4. Carefully spread butter mixture between the skin and the meat.
5. Place sliced onions and peppers between the skin and meat.
6. Sprinkle remaining seasonings over chicken.
7. Once ready, place chicken in NuWave Brio Basket breast side down and cook, pausing halfway through to flip chicken and cover with foil during remaining cooking time.
8. Let chicken rest at least 10 minutes before carving.

Tip: Make sure internal temperature of the chicken is 160-165°F.



Cajun Shrimp (Serves 2)

Time and Temp:

Prep Time: 5 minutes

Cook Time: 6 minutes

Temp: 390°F

Ingredients:

½ pound shrimp, peeled and deveined

¼ teaspoon cayenne pepper

½ teaspoon old bay seasoning

¼ teaspoon smoked paprika

1 tablespoon olive oil

pinch of salt

Directions:

1. Press “Pre-Heat”, set temperature at 390°F and set cooking time at 6 minutes. Press “Start”.
2. Add all ingredients to mixing bowl and mix until shrimp is completely coated.
3. Once ready, place shrimp in Fry Pan Basket and cook.



Chimichurri Skirt Steak (Serves 2)

Time and Temp:

Prep Time: 1 hr 30 minutes

Cook Time: 10-15 minutes

Temp: 390°F

Sauce Ingredients:

1 bunch flat leaf parsley, roughly chopped (about 1 cup, packed)	½ cup extra virgin olive oil
5 large garlic cloves, roughly chopped (about 3 tablespoons)	1 teaspoon salt
1 tablespoon dried oregano	1 teaspoon pepper
1 teaspoon crushed red pepper flakes	
½ cup distilled white vinegar	

Steak Ingredients:

1 pound skirt steak
salt and pepper to taste

Directions:

1. Place all sauce ingredients in food processor or blender and blend until just combined; set aside.
2. Place steak in bowl or container.
3. Add 4 tablespoons chimichurri sauce to container, spreading evenly on all sides of the steak.
4. Let steak marinate at room temperature for 1 hour, or in the refrigerator for at least 2 hours, or overnight.
5. Press “Pre-Heat”, set temperature at 390°F and set cooking time at 8-10 minutes. Press “Start”.
6. Once ready, season steak with salt and pepper and place in Fry Pan Basket.
7. Add additional time if you prefer your steak more done.
8. Let steak rest for 5 minutes, then slice against the grain.
9. Serve steak with remaining chimichurri sauce.

Tip: Marinate the steak in a container made from non-reactive materials, such as plastic, enamel, glass or stainless steel. If you marinate the steak in the refrigerator, allow the steak to return to room temperature before cooking. This should take about 30 minutes. Chimichurri sauce is best served at room temperature.



Grilled Ham and Cheese (Serves 2)

Time and Temp:

Prep Time: 10 minutes

Cook Time: 4-5 minutes

Temp: 360°F

Ingredients:

4 slices white bread

2 slices American cheese

2 slices of thinly sliced ham

¼ cup melted butter

Directions:

1. Press “Pre-Heat”, set temperature at 360°F and set cooking time at 4-5 minutes. Press “Start”.
2. Brush each bread slice with butter on one side.
3. Layer ham and cheese on bread and assemble sandwiches with the buttered sides of the bread out.
4. One ready, place sandwiches in Fry Pan Basket and cook until golden brown.

Tip: Use precooked bacon or sliced turkey instead of ham for a different flavor.



Tortilla Crusted Tilapia (Serves 2)

Time and Temp:

Prep Time: 5 minutes

Cook Time: 15 minutes

Temp: 375°F

Ingredients:

1 whole jalapeño, seeded & deveined

¾ cup cilantro

½ teaspoon chili powder

¼ teaspoon cumin

¼ teaspoon onion powder

1 teaspoon seasoning salt

18 whole tortilla chips

1 whole large egg, beaten

2 whole tilapia fillets

Directions:

1. Press “Pre-Heat”, set temperature at 375°F and set cooking time at 12-15 minutes. Press “Start”.
2. Add jalapeño, cilantro, chili powder, cumin, onion powder, and salt to food processor and mix to combine.
3. Add tortilla chips to food processor and mix until mixture forms small chunks.
4. Transfer chip mixture to plate.
5. Place beaten egg in small dish.
6. Dredge each tilapia fillet in egg, then chip mixture, ensuring mixture adheres to each side.
7. Once ready, spray Fry Pan Basket with non-stick cooking spray and place breaded fillets in Fry Pan Basket and cook till golden.



Salmon with Orange Curry Sauce (Serves 2)

Time and Temp:

Prep: 10 minutes

Cook: 8-10 minutes

Temp: 375°F

Curry Sauce Ingredients:

½ cup mayonnaise

2 teaspoons curry powder

¾ cup concentrated frozen orange juice

Salmon Ingredients:

1½ pounds salmon, cut into 2 fillets

2 tablespoons salt

2 tablespoons pepper

2 cups of spinach

Directions:

1. Add mayonnaise, curry powder and frozen orange juice to small bowl and stir to combine; set aside.
2. Place salmon in NuWave Brio Basket and season with salt and pepper.
3. Cook salmon at 375°F for 8-10 minutes, pausing halfway through to flip.
4. While salmon is cooking, sauté butter and spinach in fry pan on medium heat for 3-4 minutes or until wilted.
5. Once salmon is ready, place spinach on serving plate and place salmon on top.
6. Drizzle curry sauce over salmon and serve.

Tip: Curry sauce can be served either warm or cold.



Turkey Sliders (Serves 2)

Time and Temp:

Prep Time: 5 minutes

Cook Time: 10 minutes

Temp: 390°F

Ingredients:

1 pound ground turkey

2 slices colby jack cheese, cut in half

4 dinner rolls

½ teaspoon granulated garlic powder

½ teaspoon salt

½ teaspoon pepper

Directions:

1. Press "Pre-Heat", set temperature at 390°F and set cooking time at 10 minutes. Press "Start".
2. Form ground turkey into 4 (4-ounce) patties and season with salt, pepper, and garlic.
3. Once ready, add sliders to Fry Pan Basket and cook. Halfway through flip the sliders to ensure they are evenly cooked.
4. Open Air Fryer and top each slider with cheese.
5. Set cooking time at 1 minute, press "Start" and cook sliders until cheese has melted.



Apple Glazed Pork Tenderloin (Serves 4)

Time and Temp:

Prep: 20 minutes

Cook: 15 minutes

Temp: 390°F

Apple Vinegar Sauce

Ingredients:

⅓ cup of apple vinegar

½ cup of chicken broth

½ teaspoon of cinnamon

½ teaspoon of brown sugar

2 tablespoons of maple syrup

½ granny smith apple, cored and cut into ½-inch slices

Pork Tenderloin Ingredients:

1-1½ pounds pork tenderloin

2 tablespoons of salt

2 tablespoons of pepper

1 half of chopped onion

Directions:

1. Place tenderloin re-sealable plastic bag.
2. Add vinegar, salt, pepper and onion to bag, ensuring tenderloin is completely coated.
3. Seal bag and place in refrigerator to marinate for at least 20 minutes.
4. Place marinated tenderloin in NuWave Brio Basket and season with additional salt and pepper.
5. Cook tenderloin at 390°F for 15-20 minutes.
6. While tenderloin cooks, place remaining ingredients in saucepan and simmer on medium heat for 4-5 minutes.
7. Once tenderloin is cooked, remove from NuWave Brio and let sit for 3-5 minutes.
8. Cut tenderloin into ½-inch slices and top with cooked apples and sauce.

Tip: You can use any leftover sauce for dipping.



Citrus Green Beans (Serves 4)

Time and Temp:

Prep Time: 10 minutes

Cook Time: 10 minutes

Temp: 390°F

Ingredients:

1 pound green beans, washed

& de-stemmed

juice from 1 lemon

pinch salt

black pepper to taste

¼ teaspoon olive oil

Directions:

1. Press “Pre-Heat”, set temperature at 390°F and set cooking time at 10 minutes. Press “Start”.
2. Once ready, place green beans in Fry Pan Basket and cook.
3. When finished, squeeze lemon juice onto green beans.
4. Season green beans with salt and pepper and toss with oil.



Crispy Tofu (Serves 6)

Time and Temp:

Prep: 10 minutes

Cook: 8-10 minutes

Temp: 350°F

Ingredients:

12 ounces low fat, extra firm tofu

1 teaspoon sesame oil

1 teaspoon teriyaki sauce

1 tablespoon honey

2 tablespoons Sriracha sauce

2 tablespoons low sodium soy sauce

1 teaspoon oil

Directions:

1. Cut tofu into 1-inch cubes; set aside in medium bowl.
2. Combine all remaining ingredients and pour over tofu, mixing to combine.
3. Let tofu marinate for at least 30 minutes, tossing a few times.
4. Press “Pre-Heat”, set temperature at 350°F and set cooking time at 8-10 minutes. Press “Start”.
5. Once ready, add marinated tofu to Fry Pan Basket, and cook, halfway through to flip the tofu to ensure they are evenly cooked.

Tip: serve over sautéed kale and tomatoes for a complete meal.



Bacon-Wrapped Onion Rings (Serves 2)

Time and Temp:

Prep: 10 minutes

Cook: 8-10 minutes

Temp: 390°F

Ingredients:

1 large white onion

1 pound bacon

3 tablespoons Sriracha sauce (optional)

Directions:

1. Cut onion horizontally into ½-inch thick slices and separate into individual rings.
2. Brush each onion ring with Sriracha.
3. Wrap each onion rings with bacon.
4. Place bacon-wrapped onion rings in NuWave Brio Basket.
5. Cook at 390°F for 8-10 minutes.
6. Repeat air frying process with remaining rings.

Tip: Cut bacon slices in half for easier wrapping.



Party Meatballs (Serves 4)

Time and Temp:

Prep: 20 minutes

Cook: 15 minutes

Temp: 350°F

Ingredients:

1 pound ground beef

¾ cup tomato ketchup

1 tablespoon tabasco sauce

2 teaspoons worcestershire sauce

¼ cup vinegar

1 tablespoon lemon juice

½ cup brown sugar

½ teaspoon dry mustard

3 gingersnaps, crushed

Directions:

1. Add all seasonings to large mixing bowl and mix to combine.
2. Add beef to bowl and mix well.
3. Press “Pre-Heat”, set temperature at 350°F and set cooking time at 15 minutes. Press “Start”.
4. Form beef into medium sized meatballs.
5. Once ready, place meatballs in Fry Pan Basket and cook.

Tip: Do not overcrowd the Fry Pan Basket. Cook in batches if you need to.



Pasta Bake (Serves 4)

Time and Temp:

Prep: 5 minutes

Cook: 18 minutes

Temp: 390°F

Ingredients:

½ box of dry penne noodles

2 cups of heavy whipping cream

⅓ cup of milk

1 cup of shredded sharp cheese

1 cup of shredded mozzarella cheese

1 tablespoon of salt

1 tablespoon of pepper

1 teaspoon of garlic powder

5 slices of chopped Canadian bacon

1 cup of chopped broccoli

Directions:

1. Press Pre-Heat, set temperature at 390°F and set cooking time for 18 minutes, then press Start.
2. In medium bowl, combine Canadian bacon and broccoli, then mix in remaining ingredients.
3. Pour pasta mixture into NuWave Brio Baking Pan and cover with foil.
4. Once ready, place Baking Pan in NuWave Brio Basket and cook.
5. Once complete, remove foil, stir pasta and let rest for about 3-5 minutes before serving.

Tip:

- You can use any type of cheese, meat or even veggies with this dish.
- You can bake your pasta in any oven-safe dish that will fit inside the NuWave Brio.



Philly Cheese Steak Braid (Serves 6-8)

Time and Temp:

Prep: 15 minutes

Cook: 12-15 minutes

Temp: 350°F

Ingredients:

1 pound skirt steak, thinly sliced

2 tablespoons melted butter

1 tablespoon olive oil

½ onion, thinly sliced

½ green pepper, seeded, membrane removed, and thinly sliced

½ cup mozzarella cheese, shredded

1 (8-ounce) tube crescent dough

Pinch of flour

Non-stick cooking spray

Directions:

1. Add olive oil to fry pan and sauté steak on medium heat for 4-6 minutes.
2. Add onions and green pepper to pan and cook for additional 5 minutes; set aside.
3. Dust cutting board with flour.
4. Unroll crescent dough onto cutting board and shape into 1 large rectangle that will fit in NuWave Brio Basket.
5. Spoon steak mixture in a strip down the center of the dough and top with cheese.
6. Using a sharp knife, make cuts 1½ inches apart on the long sides of the dough within ½-inch of the steak mixture.
7. Twist each strip once, alternating while crossing over the filling. Tuck the short ends of the strips under and press together to seal.
8. Spray NuWave Brio Basket with non-stick cooking spray and place braid in the basket.
9. Brush braid with melted butter and cook at 350°F for 12-15 minutes.
10. Once ready, carefully remove braid, place on cutting board or serving tray and cut crosswise.

Tip: Use any meat, cheese or vegetables for a variety of fillings.



Cheesy Rice Stuffed Meatloaf (Serves 4-6)

Time and Temp:

Prep: 15 minutes

Cook: 15-20 minutes

Temp: 350°F

Ingredients:

1 pound ground beef

1 egg

2 tablespoons Worcestershire sauce

2 tablespoons salt

2 tablespoons pepper

½ cup cooked rice

½ cup chopped yellow pepper

½ cup chopped green pepper

½ cup chopped onion

1 cup mozzarella cheese, shredded

2 cups marinara sauce

Directions:

1. In large bowl, combine beef, egg, Worcestershire sauce, salt, and pepper; set aside.
2. In separate bowl, combine rice, peppers, onion, and cheese; set aside.
3. Shape beef mixture into loaf that will fit into the NuWave Brio Basket.
4. Place loaf on parchment paper or cutting board and cut in half horizontally.
5. Place rice mixture in center of bottom loaf.
6. Replace top loaf above rice mixture and seal the edges.
7. Place meatloaf in NuWave Brio Basket and cover in marinara sauce.
8. Cook at 350°F for 15-20 minutes.
9. Once complete, carefully remove meatloaf from NuWave Brio Basket and let it rest for about 10 minutes before slicing.

Tip: to add flavor, add chopped spinach, kale, parsley or cilantro to the cooked rice.



Santa Fe Stuffed Bell Peppers (Serves 4)

Time and Temp:

Prep: 10 minutes

Cook: 9 minutes

Temp: 360°F

Ingredients:

1½ cups cooked rice

1 red pepper

1 yellow pepper

1 green pepper

1 orange pepper

2 pounds ground beef

2 cups fresh spinach

1 cup mozzarella cheese, shredded

1 cup frozen corn medley

1 tablespoon cayenne pepper

2 tablespoons seasoning salt

2 tablespoons black pepper

Directions:

1. Add water to stock pot and bring to a boil.
2. While waiting for water to boil, slice off top of each pepper and remove the membrane and seeds. Set tops aside.
3. When water is at a boil, lightly drop in peppers and cook for up to 3 minutes before removing and drain on paper towel upside down.
4. Add ground beef to fry pan and brown on medium-high heat until cooked through.
5. Drain fat from fry pan and set aside.
6. Press Pre-Heat, set temperature at 360°F and set cooking time for 9 minutes, then press Start.
7. Lower stove temperature to medium and add spinach, cheese, corn and spices to ground beef, mix together and cook until spinach begins to wilt.
8. Fill each pepper with the beef mixture.
9. Once ready, place peppers in NuWave Brio Basket and cook.
10. Once cooked, transfer peppers to serving plate and top with reserved top.



Kale Chips (Serves 4)

Time and Temp:

Prep: 5 minutes

Cook: 2-3 minutes

Temp: 390°F

Ingredients:

1 head kale

1 teaspoon olive oil

1 teaspoon soy sauce

Directions:

1. Press “Pre-Heat”, set temperature at 390°F and set cooking time at 2-3 minutes. Press “Start”.
2. Remove the center stem from kale and cut leaves into 1½-inch pieces.
3. Wash kale pieces and dry thoroughly.
4. Toss kale with the olive oil and soy sauce.
5. Once ready, place kale in Fry Pan Basket, and cook, halfway through to flip the kale chips to ensure they are evenly cooked.



Roasted Tomatoes (Serves 4)

Time and Temp:

Prep: 5 minutes

Cook: 20 minutes

Temp: 320°F

Ingredients:

2 tomatoes

parsley to taste

oregano to taste

basil to taste

thyme to taste

rosemary to taste

sage to taste

black pepper to taste

non-stick cooking spray

½ tablespoon extra-virgin olive oil

Directions:

1. Press “Pre-Heat”, set temperature at 320°F and set cooking time at 20 minutes. Press “Start”.
2. Wash tomatoes and cut in half.
3. Once ready, spray bottoms of tomato halves with non-stick spray and place tomatoes in Fry Pan Basket.
4. Drizzle olive oil onto tomatoes and top with seasonings and cook.
5. Check for doneness and cook for additional 3-5 minutes if needed.



Roasted Root Vegetables (Serves 4)

Time and Temp:

Prep Time: 10 minutes

Cook Time: 35 minutes

Temp: 330°F

Ingredients:

2 carrots, peeled, halved & cut into chunks

2 parsnips, peeled, halved & cut into chunks

½ butternut squash, de-seeded, peeled & cut into chunks

4 celery stalks, peeled and cut into chunks

1 teaspoon ground cumin seeds

1 teaspoon ground coriander

1 tablespoon vegetable oil

1 teaspoon granulated garlic
salt and pepper to taste

Directions:

1. Press “Pre-Heat,” set temperature at 330°F and set cooking time at 35 minutes. Press “Start.”
2. Place all vegetables into bowl and drizzle with vegetable oil.
3. Add cumin seeds, coriander, garlic, salt, and pepper to bowl and stir well to combine.
4. Once ready, place vegetables in Fry Pan Basket, and cook, pausing halfway through to shake.



Apple Pie (Serves 2-3)

Time and Temp:

Prep Time: 10 minutes

Cook Time: 30 minutes

Temp: 320°F

Ingredients:

1 premade frozen pie crust	2 tablespoons sugar
baking spray	½ teaspoon vanilla extract
1 large apple, cored & chopped	1 tablespoon butter
2 teaspoons lemon juice	1 beaten egg
1 tablespoon ground cinnamon	1 tablespoon raw sugar

Directions:

1. Defrost pie crust according to package directions.
2. Press “Pre-Heat”, set temperature at 320°F and set cooking time at 30 minutes. Press “Start”.
3. Cut enough dough from pre-made crust to fit ⅛ inch larger than small pie tin.
4. Use remaining dough to form smaller top crust; set aside.
5. Spray baking tin with baking spray and place the larger cut crust inside the baking pan; set aside.
6. Add chopped apple, lemon juice, cinnamon, sugar, and vanilla extract to small bowl and mix to combine.
7. Pour apple mixture into prepared pie crust.
8. Top apples with butter, spreading evenly.
9. Top pie with second pie crust and pinch edges closed. Make a few slits in the top of the dough.
10. Spread beaten egg onto pie crust and sprinkle on raw sugar.
11. Once ready, place pie in Fry Pan Basket, and bake.

Tip: If necessary, roll the larger crust with a rolling pin to stretch to a uniform thickness. Any baking tin 7 inches wide or smaller will fit in the Air Fryer.



Banana and Nutella Wontons (Serves 4)

Time and Temp:

Prep Time: 10 minutes

Cook Time: 6-8 minutes

Temp: 350°F

Ingredients:

8 wonton wrappers

8 teaspoons nutella

1 banana

1 egg

1 teaspoon water

cinnamon sugar or powdered sugar
for garnish

Directions:

1. Press "Pre-Heat", set temperature at 350°F and set cooking time at 6-8 minutes. Press "Start".
2. Add egg and water to small bowl and mix together to make egg wash.
3. Place 1 teaspoon Nutella in center of wonton wrapper.
4. Slice banana and place atop Nutella.
5. Brush egg wash along two sides of the wonton.
6. Seal wonton wrapper by folding the sides together.
7. Once ready, place wontons in Fry Pan Basket and cook.
8. Once the wontons have sufficiently browned, carefully remove from the Air Fryer and dust with cinnamon sugar or powdered sugar.



Pineapple Crescents (Serves 4)

Time and Temp:

Prep Time: 20 minutes

Cook Time: 10 minutes

Temp: 350°F

Ingredients:

½ pineapple

½ cup shredded coconut

1 small sprig fresh mint

1 cup vanilla yogurt

Directions:

1. Cut pineapple into ½-inch thick slices, cut slices in half, and remove the core.
2. Press “Pre-Heat”, set temperature at 350°F and set cooking time at 10 minutes. Press “Start”.
3. Dip pineapple slices into shredded coconut.
4. Once ready, gently place pineapple in Fry Pan Basket and cook.
5. While pineapple cooks, finely dice mint leaves and stir into vanilla yogurt.
6. Serve pineapple with yogurt dip.



Apple Pie Egg Rolls (Yield 6 Egg Rolls)

Time and Temp:

Prep Time: 15 minutes

Cook Time: 8-10 minutes

Temp: 390°F

Ingredients:

8 tablespoons unsalted butter

3 granny smith apples, peeled, cored,
and cut into ¼-inch cubes

½ tablespoon vanilla extract

½ teaspoon cinnamon

½ cup sugar

Pinch salt

2 tablespoons all-purpose flour

2 tablespoons lemon juice

6 egg roll wrappers

¼ stick melted butter

Non-stick cooking spray

Directions:

1. Add unsalted butter, apples, vanilla, cinnamon, sugar, salt, flour, and lemon juice to saucepan bring to a simmer on medium-high heat and simmer for 2-3 minutes.
2. Reduce heat to medium-low and continue simmering for 2-3 minutes.
3. Remove pan from heat and let apple mixture cool; set aside.
4. Lay out egg roll wrappers on cutting board in a diamond shape.
5. Brush edges of wrappers with melted butter.
6. Place about 2 tablespoons of apple mixture in center of each wrapper, leaving about 1-inch of space along the edges.
7. Fold end of wrapper nearest to you over the filling to seal, then fold sides over and roll the wrapper into a tight cylinder shape.
8. Spray NuWave Brio Basket with non-stick cooking spray.
9. Place egg rolls in NuWave Brio Basket and cook at 390°F for 8-10 minutes.
10. Serve immediately.

Tip: Sprinkle the egg rolls with powdered sugar for a nice final touch.



Berry Cheesecake Egg Rolls (Yield 6 Egg Rolls)

Time and Temp:

Prep Time: 10 minutes

Cook Time: 8-10 minutes

Temp: 390°F

Ingredients:

4 ounces cream cheese, softened

3 tablespoons sugar

½ teaspoon lemon juice

½ cup mixed berries

6 egg roll wrappers

¼ stick melted butter

Directions:

1. In small mixing bowl, combine cream cheese, sugar, and lemon juice.
2. Lightly mix in berries and set aside.
3. Lay out egg roll wrappers on cutting board in a diamond shape.
4. Brush edges of wrappers with melted butter.
5. Place about 2 tablespoons of berry mixture in center of each wrapper, leaving about 1-inch of space along the edges.
6. Fold end of wrapper nearest to you over the filling to seal, then fold sides over and roll the wrapper into a tight cylinder shape.
7. Spray NuWave Brio Basket with non-stick cooking spray.
8. Place egg rolls in NuWave Brio Basket and cook at 390°F for 8-10 minutes.
9. Serve immediately.

Tip: Sprinkle the egg rolls with powdered sugar for a nice final touch.



Easy Blueberry Muffins (Yield 12 Muffins)

Time and Temp:

Prep Time: 10 minutes

Cook Time: 14-16 minutes

Temp: 300°F

Ingredients:

1 (6.5 oz. box) of your favorite muffin mix

¼ cup of blueberries

Directions:

1. According to package directions combine package mix.
2. Gently fold into blueberries.
3. Spray each cooking liner with cooking spray.
4. Pour into 12 Silicone liners.
5. Place 6 Silicone cupcake liners in the basket.
6. Set Brio for 300°F and cook for 14-16 minutes.
7. Repeat step 5 for the remaining cupcake liners.

nuwave[®]
— LIVE WELL FOR LESS —



NuWave[®] **Brio Healthy** **Freidora Digital de Aire** **de 6Q**



Manual del Usuario

GUÍA

La siguiente guía indica la cantidad de tiempo, temperatura y peso para los diferentes tipos de comida que se enlistan a continuación:

Tipo de Comida	Mover/ Voltear	Tiempo (mins)	Temp (°C)	Cantidad Sugerida	Notas Adicionales
Barritas Congeladas de Pan Francés	Voltear	8-10	193	8 oz	/
Tortitas de Hash Brown Congeladas	Voltear	18-25	182	1-4 tortitas	/
Rollos de Canela	/	10-12	176	1-5 rollos	Cubrir con aluminio (a la ½ del tiempo)
Papas a la Francesa Delgadas Congeladas	Mover	8-14	204	28 oz	/
 Papas a la Francesa Gruesas Congeladas	Mover	14-17	204	24 oz	Corte Medio-Grueso
 Papas a la Francesa Caseras	Mover	20-25	182	12-16 oz	Remojar en Agua por 30 minutos
Gajos de Papa Caseros	Mover	20-25	182	12-16 oz	Remojar en Agua por 30 minutos
Cubos de Papa Caseros	Mover	15-20	182	12-16 oz	Remojar en Agua por 30 minutos
 Carne (½" ribeye)	Voltear	12-18	182	1-4 (8 oz c/u)	/
Chuletas de Cerdo (con hueso)	Voltear	15-20	190	1-3 (8-12 oz c/u)	/
Hamburguesas Congeladas	Voltear	16-20	182	1-2 (5 oz c/u)	/
Hamburguesas Frescas	Voltear	12-16	182	1-4 (8 oz c/u)	/
Salchicha Italiana	Voltear	13-15	204	3-7 (4 oz c/u)	/
Alitas de Pollo	Mover	20-25	198	24 oz	/
 Aves	Voltear	11-14	182	1-2 (8 oz c/u)	Pechuga de Pollo
Jamón en Espiral	/	9-10 min/ lb	148	Hasta 5 lbs	Cubrir con Aluminio
Jamón sin Hueso	/	11-13 min/lb	148	Hasta 7 lbs	Cubrir con Aluminio
Pollo Entero	Voltear	10-12 min/lb	190	Hasta 6 lbs	Cubrir con Aluminio
Tater Tots Congeladas	Mover	6-8	182	16-20 oz	/
Rollos Primavera	Mover	6-8	182	16 oz	/
 Nuggets de Pollo	Mover	8-12	198	12 oz	/
 Pescado	Mover	6-10	204	12 oz	Palitos de Pescado Congelados

GUÍA (Continued)

Tipo de Comida	Mover/ Voltar	Tiempo (mins)	Temp (°C)	Cantidad Sugerida	Notas Adicionales
Chiles Rellenos	Mover	8-10	182	12 oz	/
Aros de Cebolla	Mover	12-16	182	16 oz	/
Champiñones Empanizados	Mover	8-10	198	12 oz	/
Palitos de Mozzarella/ Calabacin	Mover	5-7	182	16 oz	/

Nota: Los tiempos de cocción actuales pueden variar dependiendo del tamaño y forma de los ingredientes utilizados. Los tiempos de cocción enlistados deberán ser utilizados como una guía. Ajuste los niveles cuanto sea necesario para cubrir sus necesidades. De acuerdo con la FDA, la temperatura interna segura es de 74°C para aves y de 71°C para cerdo.

MEDIDAS DE SEGURIDAD IMPORTANTES

LEA TODAS LAS INSTRUCCIONES

Al utilizar unidades eléctricas, siempre deben tomarse precauciones básicas de seguridad, incluyendo las siguientes:

1. No toque las superficies calientes.
2. Para evitar una descarga eléctrica, no sumerja el cable, la clavija o la unidad en agua u otros líquidos.
3. Cuando una unidad sea usada por o cerca de niños, debe haber una supervisión de cerca.
4. Desconecte del contacto cuando no se use y antes de limpiar. Permita que se enfríe antes de quitar o colocar cualquier parte.
5. No se recomienda el uso de otros accesorios no diseñados para esta unidad. Al hacerlo, la unidad podría provocar accidentes.
6. NO ES APTO PARA USO EN EXTERIORES.
7. No permita que el cable cuelgue de la orilla de la mesa o barra, o que toque la superficie caliente.
8. No colocar sobre o cerca de alguna estufa eléctrica o de gas, o dentro de un horno caliente.
9. Debe extremarse precaución al mover una unidad que contenga aceite u otros líquidos calientes.
10. Para desconectar, gire todos los controles a "OFF" y luego retire la clavija del contacto.
11. Nunca coloque el aparato pegado a la pared u otros aparatos. Debe haber al menos 3 pulgadas de espacio a la parte de atrás, los lados o la parte de arriba. No coloque nada encima del aparato.

MEDIDAS DE SEGURIDAD IMPORTANTES

12. Durante el freído se libera vapor caliente por la salida de aire. Mantenga sus manos y rostro a distancia de esta salida. También tenga cuidado con el vapor caliente cuando retire la Canasta del aparato.
13. Asegúrese de que los alimentos salgan dorados-amarillos y no oscuros o cafés. Retire los restos de quemadura.

	⚠ ADVERTENCIA
	Corte la energía inmediatamente y envíe la unidad a nuestro Departamento de Servicio al Cliente en caso de otros problemas. 1-877-689-2838 • help@nuwavenow.com

NO UTILICE EL DISPOSITIVO PARA OTRO USO QUE NO SEA EL PREVISTO.

Nota: Coloque el aparato sobre una superficie que sea horizontal, plana y estable. Este aparato es para uso doméstico normal. No está diseñado para usarse en ambientes como cocinas de restaurantes, oficinas, casas de campo u otros ambientes laborales. Tampoco está hecho para usarse por clientes de hoteles, moteles, hostales u otros ambientes de hospedaje.

GUARDE ESTAS INSTRUCCIONES

1. No coloque la unidad cerca de materiales inflamables, cosas calientes o en ambientes húmedos.
2. La altura de los ingredientes a colocar en la Canastilla debe cumplir con lo señalado en las “Instrucciones de Funcionamiento”.
3. No remplace con otras partes que no estén específicamente diseñadas para la Freidora Digital de Aire NuWave Brio Healthy 6-Qt.
4. No coloque ninguna otra cacerola en la Canastilla. No reemplace ninguna parte con otros contenedores.
5. Si sale mucho humo del respiradero mientras está funcionando, desconecte la unidad inmediatamente y contacte a Servicio al Cliente.*
6. No mueva el aparato mientras esté funcionando. Sólo intente manejarlo hasta que la Freidora Digital de Aire NuWave Brio Healthy 6-Qt. se haya enfriado completamente.
7. Nunca obstruya el respiradero con una toalla.
8. Si aparece algún problema durante la operación, toda reparación debe hacerse por parte de NuWave, LLC o alguien autorizado por el fabricante.
9. No desarme el aparato por su cuenta ni reemplace ninguna parte.
10. No utilice utensilios de metal con la canastilla recubierta, ya que podría dañar la superficie.
11. No intente usar el aparato si el cable se daña.*
12. Mantenga el aparato fuera del alcance de los niños.
13. Mantenga manos y rostro lejos de la salida de ventilación o de donde el vapor esté saliendo.
14. Asegúrese de que la Freidora Digital de Aire NuWave Brio Healthy 6-Qt esté siempre limpia antes de cocinar.
15. Es normal que salga un poco de humo cuando se use por primera vez.

* Departamento de Servicio al Cliente al 1-877-689-2838
help@nuwavenow.com

PRECAUCIÓN



- Siempre coloque los alimentos por freír en la Canastilla para evitar que entren en contacto con los componentes calientes.
- No obstruya la válvula de aire y la salida mientras el aparato esté funcionando.
- No vierta aceite en la Cacerola, ya que podría haber un riesgo de incendio.
- Nunca toque el interior del aparato mientras esté funcionando

DESCRIPCIÓN DE LAS PARTES

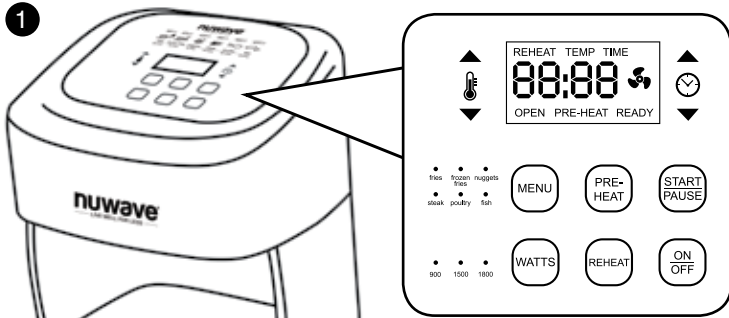

1. Fuente de Potencia de la Freidora de Aire
Parte #: 37206

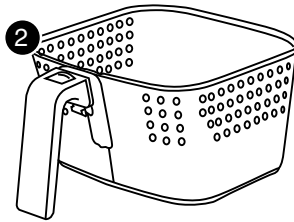

2. Canastilla para Freir
Parte #: 37202

3a. Divisor para la Canastilla
Parte #: 37205

3b. 4 Pestañas de Silicón
Part #: 37207

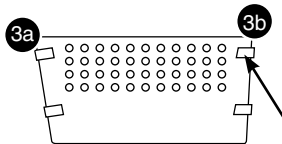

Pestañas de Silicón

4. Cacerola
Parte #: 37201

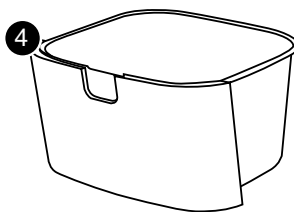

INSTRUCCIONES DE FUNCIONAMIENTO

Antes de Usarse:

1. Retire todo el material de empaque.
2. Retire el pegamento y las etiquetas del aparato.
3. Limpie muy bien la Canastilla y la Cacerola con agua caliente, esponja y detergente suave o, en el lavavajillas, sólo en la parte superior.
4. Limpie con trapo húmedo el interior y exterior del aparato. No lo sumerja en agua.

Nota: Este aparato cocina usando aire caliente. NO llene la canastilla con aceite.

Preparación para el Uso:

1. Coloque el aparato en una superficie plana, estable y resistente al calor.
2. Coloque la Cacerola y la Canastilla en la Freidora Digital de Aire NuWave Brio Healthy 6-Qt.
3. Conecte el aparato en un contacto de pared estándar. Se incluye el cable en el paquete.

Nota: No cubra u obstruya el respiradero localizado en la parte de arriba de la Freidora Digital de Aire NuWave Brio Healthy 6-Qt para que tenga buena ventilación y no afecte los resultados de cocción.



Función Encendido/Apagado:

Presione el botón "On/Off" una vez para encender el aparato. El panel de control mostrará "0" indicando que aún no se ha seleccionado tiempo o temperatura y el aparato está encendido. Presione "On/Off" otra vez para apagar la unidad.

Función de Potencia Eléctrica:

La potencia eléctrica automática de la Freidora de Aire Digital NuWave Brio Healthy 6-Qt. es de 1800 watts. Para cambiar estos watts, presione "Watts" una vez. La luz roja sobre "900" se iluminará indicando que la Freidora de Aire Digital NuWave Brio Healthy 6-Qt. está ahora en 900 watts. Presione "Watts" una vez más y la luz roja sobre "1500" se iluminará indicando que la Freidora está en 1500 watts. Presione "Watts" otra vez y la luz roja sobre "1800" se iluminará indicando que la Freidora de Aire Digital NuWave Brio Healthy 6-Qt. está ahora en los 1800 watts como en un inicio.

Si cambia el vatiaje del 1800W predeterminado a 900W o 1500W y desenchufe la unidad, el NuWave Brio recordará el último ajuste de vatiaje cuando vuelva a enchufarlo.

OPERATING INSTRUCTIONS



Función de Inicio Rápido/Pausa:

- Presione el botón "Start/Pause" una vez para empezar a cocinar, se mostrará un ":15" así como un ícono de ventilador y la Freidora de Aire Digital NuWave Brio Healthy 6-Qt. comenzará la cuenta regresiva. Está automáticamente a 360°F por 15 minutos.
- Para interrumpir el proceso de cocción, presione el botón "Start/Pause" otra vez.
- To resume cooking or preheating, press the "Start/Pause" button again.

Selección de Menú:

Presione "Menu". La luz roja sobre las papas a la francesa se iluminará y se mostrará un "360". Presione "Start/Pause" para comenzar a cocinar. La cuenta regresiva iniciará. Para seleccionar un platillo diferente, presione "Menu" para elegirlo antes de presionar "Start/Pause". Vea la siguiente tabla de selecciones pre-programadas de "Menu".

Para salir de la selección de Menu, presione "Menu" otra vez hasta que la luz roja sobre los tipos de platillos ya no está iluminada. Si utiliza la función de Precalentar, presione "Pre-Heat" antes de "Menu" para asegurarse de usar la temperatura adecuada. Todas las selecciones de menú están automáticamente a 1800 watts.

Tipo de Platillo	Tiempo (minutos)	Temp	Cantidad (onzas)
 Papas a la Francesa (Caseras y gruesas)	25	182°C	8-12
 Papas a la Francesa Congeladas (corte medio)	15	204°C	28
 Nuggets de Pollo	8	204°C	12
 Carne (½" ribeye)	12	182°C	8 oz each
 Aves (Pechuga de pollo)	12	182°C	8 oz each
 Pescado (Palitos de Pescado Congelados)	8	204°C	12



Función de Precalentar:

La función de Precalentar asegura que la Freidora Digital de Aire NuWave Brio Healthy 6-Qt alcance la temperatura deseada antes de que comience a cocinar sus alimentos. La función Precalentar es la opción perfecta para alimentos que requieren una textura más crujiente, como botanas congeladas, papas a la francesa o alitas de pollo. Presione el botón "Pre-Heat". El panel de control mostrará "0" y "Pre-Heat".

OPERATING INSTRUCTIONS (Continued)

PRE-HEAT

Presionando “Start/Pause” se irá automáticamente a 360°F por 15 minutos. 360 parpadeará junto con el ícono de ventilador. Ajuste manualmente la temperatura y el tiempo si fuera necesario, luego presione “Start/Pause”. Una vez presionado “Start”, la temperatura deseada parpadeará y se mostrará “Pre-Heat”.

Una vez que la Freidora Digital de Aire NuWave Brio Healthy 6-Qt. alcanza la temperatura elegida, el panel de control mostrará “Ready” y la Freidora Digital de Aire NuWave Brio Healthy 6-Qt sonará una vez. La Freidora Digital de Aire NuWave Brio Healthy 6-Qt comenzará una cuenta regresiva de 5 minutos y el número “5” parpadeará. Se mantendrá a esta temperatura por hasta 5 minutos o hasta que se retire la Canastilla.

Una vez que los alimentos se hayan colocado en la Canastilla, insértela de regreso en su lugar. Así comenzará la cuenta regresiva del tiempo elegido.

Nota: Si se retira la Canastilla en cualquier momento de la etapa de precalentamiento, la Freidora Digital de Aire NuWave Brio Healthy 6-Qt. automáticamente se pausará y comenzará una cuenta de 5 minutos hasta que se vuelva a colocar la Canastilla. Una vez que la Freidora Digital de Aire NuWave Brio Healthy 6-Qt muestre “ready” en el display, abra y coloque la canastilla de vuelta para comenzar con la cuenta regresiva.

Si usted cocinara otro tanto de comida casi inmediatamente después de usar la Freidora Digital de Aire NuWave Brio Healthy 6-Qt. no necesitará usar la función de Precalentar ya que la Freidora Digital de Aire NuWave Brio Healthy 6-Qt. ya estará caliente. Si usted desea cocinar su comida más tiempo, solamente coloque la Cacerola y la Canastilla dentro del aparato y continúe cocinando por incrementos de 2-3 minutos hasta alcanzar la consistencia deseada.



Ajuste de Temperatura:

La Freidora Digital de Aire NuWave Brio Healthy 6-Qt. está programada para cocinar automáticamente a 360°F. Para establecer una temperatura diferente, presione las flechas arriba y abajo del ícono Temp. El display mostrará “360°F” y “Temp” parpadeará. Para ajustar la temperatura, continúe presionando las flechas de arriba o abajo. Se puede ajustar la temperatura en incrementos de 5 grados desde 100°F hasta 400°F.

OPERATING INSTRUCTIONS (Continued)



Para ajustar rápidamente la temperatura en incrementos grandes, solamente **mantenga presionada** la flecha (de arriba o abajo) para ajustar la temperatura en incrementos de 50°. Se puede cambiar la temperatura en cualquier momento del proceso. Presione las flechas arriba y abajo del ícono Temp. La temperatura programada se mostrará y “Temp” parpadeará. Presione la flecha de arriba o la de abajo hasta alcanzar la temperatura deseada.

Una vez elegida la temperatura, la Freidora Digital de Aire NuWave Brio Healthy 6-Qt automáticamente se ajustará a la nueva temperatura y el display mostrará el tiempo restante. Si no se selecciona una nueva temperatura en 3 segundos, la Freidora Digital de Aire NuWave Brio Healthy 6-Qt mostrará nuevamente el tiempo restante.

Ajuste de Tiempo:



La Freidora Digital de Aire NuWave Brio Healthy 6-Qt. está programada para cocinar automáticamente por 15 minutos. Para establecer un tiempo diferente, presione las flechas arriba y abajo del ícono Time. El display mostrará “15” y “Time” parpadeará. Para ajustar el tiempo continúe presionando las flechas “Up” (arriba) o “Down” (abajo). Se puede ajustar el tiempo en incrementos de 1 minuto.

Para ajustar rápidamente el tiempo en incrementos grandes, solamente mantenga **presionada** la flecha “Up” o “Down” (arriba o abajo) para ajustar en incrementos de 10 minutos, seguido por incrementos de 20 minutos, seguido por incrementos de 30 minutos. El tiempo mínimo a seleccionar es de 1 minuto y el máximo dependerá de la temperatura seleccionada.

- Para 37°C – 173°C, el tiempo máximo es de 16 horas
- Para 176°C – 198°C, el tiempo máximo es de 1 hora

Se puede cambiar el tiempo en cualquier momento del proceso. Presione las flechas arriba y abajo del ícono Time y el tiempo restante se mostrará. Presione la flecha de arriba o la de abajo hasta alcanzar el tiempo deseado. Una vez elegido el tiempo, el display mostrará el nuevo tiempo restante

Nota: Una vez que el tiempo alcance 1 minuto, el display comenzará a mostrar el tiempo restante en segundos (59, 58, etc.).

OPERATING INSTRUCTIONS (Continued)



Función de Recalentar:

Está programada automáticamente a 360°F, 1800 Watts y 4 minutos. Esta función es perfecta para recalentar porciones individuales de comida. Presione el botón Reheat, el cual activará el ajuste automático. Por ejemplo, si está recalentando pizza, sólo coloque la rebanada en la canastilla dentro de un contenedor apto para horno (vidrio, metal, silicón). Para obtener arroz o fideos más suaves, rocíe con un poco de agua y cubra con papel aluminio.

Para Mejores Resultados

Una vez seleccionado el tiempo y la temperatura y estar listo para colocar los alimentos en la Freidora de Aire NuWave Brio Healthy 6-Qt.: Jale la Cacerola y la Canastilla de la Freidora de Aire NuWave Brio Healthy 6-Qt. (Fig. 1).



OPERATING INSTRUCTIONS (Continued)

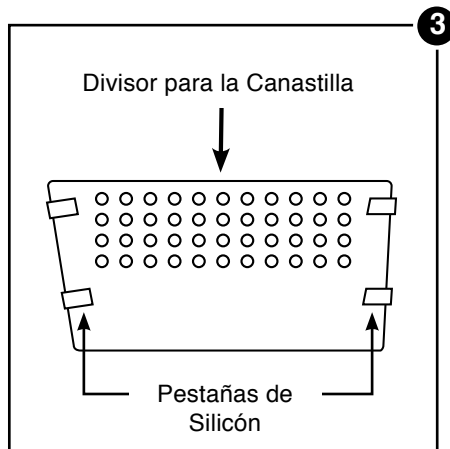
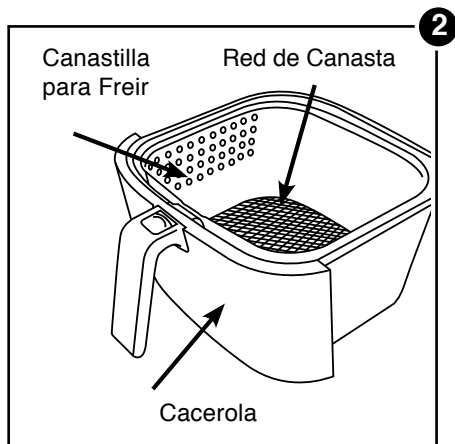

Nota: No llene más de $\frac{4}{5}$. Meta la cacerola en su lugar en la Freidora de Aire NuWave Brio Healthy 6-Qt. No utilice la cacerola sin la canastilla adentro. (Fig. 2) No toque dentro de la Cacerola inmediatamente después de cocinar, ya que puede estar muy caliente. Sólo tómla por el mango.

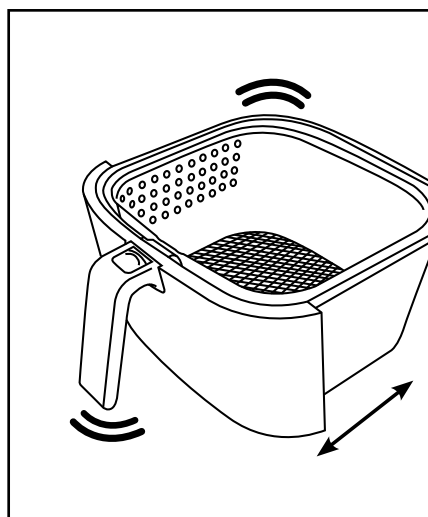

Mover los Alimentos:

Algunos alimentos necesitan ser movidos a la mitad de la cocción. Para mover los alimentos correctamente, tome el mango, saque la Cacerola del aparato y agite. Una vez que se haya realizado adecuadamente, meta la Cacerola y la Canastilla nuevamente dentro de la Freidora Digital de Aire NuWave Brio Healthy 6-Qt.

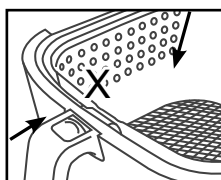

NO PRESIONE EL BOTÓN DE DESMONTAJE MIENTRAS AGITA.

OPERATING INSTRUCTIONS (Continued)

Pestañas de Silicón

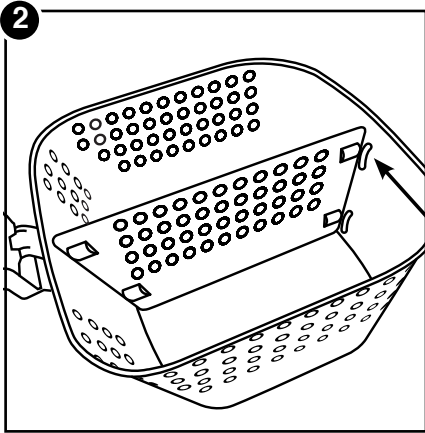
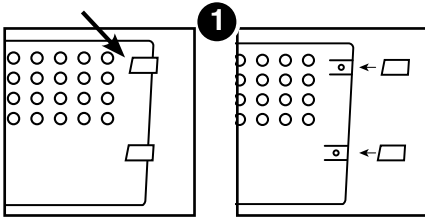

Uso del Divisor:

Fig. 1.

Asegúrese de que las 4 pestañas de silicón estén colocadas en el divisor.

Fig. 2.

Mirando la canastilla hacia abajo, meta el divisor en el centro de la canastilla. Asegúrese de que el divisor esté entre los separadores y los tornillos de la canastilla.

Para retirar el divisor solamente jálalo hacia arriba.

Puede quitar las pestañas de silicón del divisor para limpiarlas.

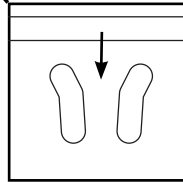

OPERATING INSTRUCTIONS (Continued)

Retire la Canastilla:

Para sacar la Canastilla de la Cacerola:

1. Presione el botón de desmontaje hacia adelante.

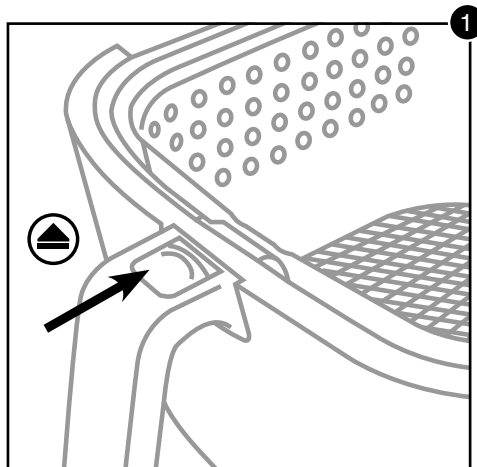

2. Levante la Canastilla de la Cacerola.
Esto reducirá el peso extra de la Cacerola y hará más fácil el colocar alimentos pequeños, como papas a la francesa.

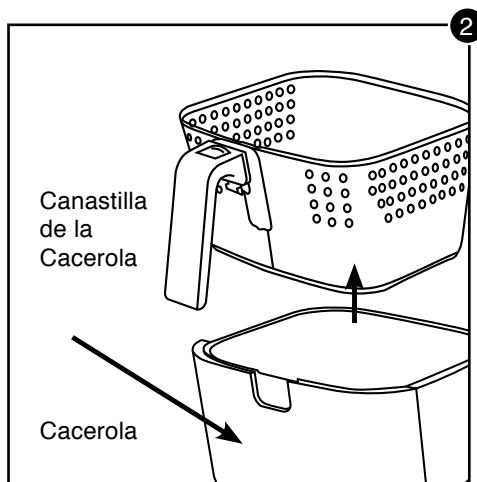

OPERATING INSTRUCTIONS (Continued)

- Desconecte el aparato y asegúrese de que se enfríe por completo.

Nota: Retire la Cacerola y la Canastilla y colóquelas sobre una superficie resistente al calor para ayudar a que se enfríen más rápido.

- Utilice un trapo húmedo para limpiar la parte exterior del aparato.
- **El Divisor se puede retirar de la Canastilla para limpiar fácilmente.** Limpie la Canastilla, el Divisor y los componentes internos con una esponja y detergente suaves y agua caliente.

Nota: Si coloca la Cacerola, el Divisor y la Canastilla en el lavavajillas, utilice sólo la parte superior.

Consejo: Si queda comida pegada en la Cacerola, el Divisor o la Canastilla, agregue un poco de agua caliente y deje remojar por unos 10 minutos para limpiarlos más fácilmente.

- Limpie el interior del aparato con una esponja suave y agua caliente.
- Una vez que se haya enfriado completamente, limpie la Canastilla, el Divisor y la Cacerola con un cepillo suave para quitar cualquier rastro de comida.

Almacenamiento: Desconecte al aparato y déjelo enfriar completamente

- Asegúrese de que todas las partes estén limpias y secas.
- Empuje el cable hacia la cápsula de almacenamiento para guardarlo; arréglo insertándolo en el compartimento.

IMPORTANTE - No sumerja la unidad en agua ni intente lavarla en el lavavajillas. La superficie exterior podrá ser limpiada cuidadosamente con un trapo o esponja húmedos. Asegúrese de que la unidad se ha enfriado completamente antes de limpiarla.



CUIDADO & MANTENIMIENTO

Limpieza:

Limpie el aparato después de cada uso o en el inter de muchos usos. La Canastilla y la Cacerola cuentan con una cubierta anti adherente con una Canastilla de acero inoxidable. No utilice utensilios de metal o materiales abrasivos cuando lo limpie, ya que puede dañar dicha cubierta.

Pestañas de Silicón

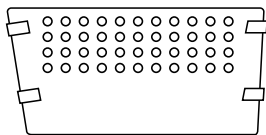

Canastilla para Freir

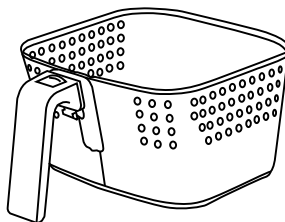

GUÍA DE SOLUCIÓN DE PROBLEMAS

PROBLEMA	POSIBLE CAUSA(S)	SOLUCIÓN (ES)
La Freidora Digital de Aire NuWave Brio Healthy 6-Qt. no funciona.	<p>El aparato no está conectado. No se presionó el botón ON/OFF.</p> <p>No está la Canastilla en la Freidora Digital de Aire NuWave Brio. Healthy 6-Qt.</p>	<p>Conecte la clavija en un contacto apropiado. Presione el botón ON/OFF después de seleccionar los ajustes.</p> <p>Coloque la Canastilla en la Freidora Digital de Aire NuWave Brio.6-Qt.</p>
Los ingredientes en la Canastilla no están lo suficientemente fritos.	<p>Se usaron demasiados ingredientes.</p> <p>La temperatura es muy baja.</p> <p>El tiempo es muy corto</p>	<p>Quite algunos ingredientes de la Canastilla.</p> <p>Las porciones pequeñas se fríen mejor.</p> <p>Fría a una temperatura más alta.</p> <p>Programe la Freidora por más tiempo</p>
La comida no se fríe uniformemente.	Algunos alimentos necesitan ser movidos a la mitad del tiempo de preparación.	Los alimentos de encima necesitan ser movidos a la mitad el tiempo de preparación.
Las botanas fritas no salen crujientes de la Freidora Digital de Aire NuWave Brio Healthy 6-Qt.	Se utilizó un tipo de botana que está diseñada para prepararse en una freidora tradicional.	Utilice botanas hechas para hornos tradicionales o cepille las botanas con aceite de oliva para que queden crujientes.
No se puede meter la Canastilla en el aparato correctamente.	<p>La Canastilla está muy llena.</p> <p>La Canastilla no está colocada correctamente en la Cacerola.</p>	No llene la Canastilla más de un 4/5 partes. Presione la Canastilla hacia abajo en la Cacerola hasta que escuche un click.

TROUBLESHOOTING GUIDE

PROBLEM	POSSIBLE CAUSE(S)	RESOLUTION(S)
Sale humo blanco del aparato.	Está friendo alimentos grasosos. La Cacerola tiene residuos grasosos de los usos anteriores.	Cuando se preparen alimentos grasosos en la Freidora Digital de Aire NuWave Brio Healthy 6-Qt. pueden surgir grandes cantidades de humo y adherirse a la Cacerola. La grasa producirá humo blanco y la Cacerola puede calentarse más de lo habitual. Esto no afectará el efecto final. El humo blanco es causado por la grasa caliente en la cacerola. Asegúrese de limpiar la cacerola correctamente después de cada uso.
Las papas a la francesa no se fríen uniformemente en la Freidora Digital de Aire NuWave Brio Healthy 6-Qt.	Las papas no se remojaron bien antes de freírlas. No se utilizó el tipo de papa correcto.	Remoje las papas en un recipiente por al menos 30 minutos. Sáquelas y séquelas con una toalla de papel. Utilice papas frescas y asegúrese de que estén firmes durante su cocción.
Las papas a la francesa no salen crujientes de la Freidora Digital de Aire NuWave Brio Healthy 6-Qt.	Lo crujiente de las papas depende de la cantidad de aceite y agua en ellas.	Asegúrese de secar bien las papas antes de ponerles aceite. Corte las papas más pequeñas o agregue un poco más de aceite para que queden más crujientes.
Si la unidad necesita ser reemplazada o devuelta al fabricante, contacte a nuestro Departamento de Servicio al Cliente al 1-877-689-2838 help@nuwavenow.com		

Contacte a Servicio al Cliente si ocurre alguno de estos errores

Código	E1	E2	E3
Error	Sensor abierto	Corto circuito en el sensor	Sobrecalentamiento

GARANTÍA

La Freidora de Aire Digital NuWave Brio Healthy 6-Qt. EL FABRICANTE GARANTIZA

La Freidora de Aire Digital NuWave Brio Healthy 6-Qt. incluyendo la Cacerola, el Divisor y la Canastilla están libres de defectos de fabricación.

Todos los componentes eléctricos están garantizados por 1 año a partir de la fecha de compra, bajo un uso doméstico normal y siempre que se hayan manejado de acuerdo a las instrucciones por escrito del Fabricante. El Fabricante proporcionará las partes necesarias y mano de obra para reparar cualquier parte de la Freidora de Aire Digital NuWave Brio Healthy 6-Qt. en el Departamento de Servicio de NuWave, LLC. Una vez vencida la garantía, el costo de mano de obra y las partes será responsabilidad del propietario.

LA GARANTÍA NO CUBRE

La Garantía Limitada se invalida si la reparación es hecha por un distribuidor no autorizado o si la placa del número de serie es retirada o maltratada. El deterioro normal del acabado, por uso o exposición, no está cubierto por esta Garantía. Esta Garantía Limitada tampoco cubre fallas, daños o desempeño inadecuado por accidentes, desastres naturales (como relámpagos), variaciones en la potencia eléctrica, alteraciones, abuso, mal uso, ambientes corrosivos, instalación inadecuada, o falla en la operación de acuerdo con las instrucciones escritas por el Fabricante, uso no normal o comercial.

NuWave, LLC se reserva el derecho de invalidar la Garantía Limitada, donde lo permita la ley, a los productos que hayan sido comprados a distribuidores no autorizados.

PARA OBTENER EL SERVICIO

El propietario tendrá la obligación y responsabilidad de: Pagar por todos los servicios y partes no cubiertas por la garantía; Prepagar el envío hacia y desde el Departamento de Servicio para cualquier parte o sistema devuelto bajo esta garantía; Empacar cuidadosamente el producto utilizando el material de relleno adecuado para prevenir cualquier daño durante el tránsito. El empaque original es ideal para este propósito. Incluya en el empaque el nombre del propietario, dirección, teléfono durante el día, una descripción detallada del problema y su “**número RGA**”. Llame al **1-877-689-2838** o escriba a **help@nuwavenow.com** para obtener el **RGA (Número de Autorización de Devolución del Producto)**. Proporcione el modelo del producto, el número de serie y comprobante de la fecha de compra (una copia del recibo) cuando reclame su garantía.

OBLIGACIONES DEL FABRICANTE

La obligación del Fabricante bajo esta Garantía Limitada está limitada, hasta lo permitido por ley, a reparar o reemplazar cualquier parte cubierta por esta Garantía Limitada cuya revisión muestre que el defecto es por uso normal. La Garantía Limitada aplica únicamente en los Estados Unidos y sólo para el comprador original en los canales de distribución autorizados por el fabricante. LA GARANTÍA LIMITADA NO PUEDE SER ALTERADA, CAMBIADA O EXTENDIDA EXCEPTO POR UN INSTRUMENTO POR ESCRITO

GARANTÍA

REALIZADO POR EL FABRICANTE. LA SOLUCIÓN DE REPARACIÓN O REEMPLAZO INCLUIDA EN ESTA GARANTÍA ES EXCLUSIVA. EN NINGÚN CASO EL FABRICANTE SERÁ RESPONSABLE DE NINGÚN DAÑO RELEVANTE O FORTUITO A ALGUNA PERSONA, SEA O NO OCASIONADO POR LA NEGLIGENCIA DEL FABRICANTE, INCLUYENDO, SIN LÍMITE, DAÑOS POR PÉRDIDA POR USO, COSTOS POR REEMPLAZO, DAÑO A LA PROPIEDAD, U OTRAS PÉRDIDAS MONETARIAS

Algunos estados no permiten la exclusión o limitación de daños relevantes o fortuitos, así que la exclusión mencionada podría no aplicar. Esta Garantía Limitada proporciona derechos legales específicos y podría haber otros derechos que varíen entre estado y estado. EXCEPTO POR LO QUE YA SE EXPRESÓ DE FORMA DIFERENTE, EL FABRICANTE NO GARANTIZA EXPRESA O IMPLÍCITAMENTE POR LEY U OTRAS, INCLUYENDO SIN LIMITACIONES, LAS GARANTÍAS IMPLÍCITAS DE COMERCIALIZACIÓN Y EJERCICIO PARA UN PROPÓSITO PARTICULAR A CUALQUIER OTRA PERSONA. LEA EL MANUAL DEL USUARIO. SI TUVIERA ALGUNA DUDA SOBRE EL FUNCIONAMIENTO O LA GARANTÍA DEL PRODUCTO, CONTACTE A NUWAVE, LLC.

LEA SU MANUAL DEL USUARIO: Si tuviera alguna duda sobre el funcionamiento o la garantía del producto, contacte a **NuWave, LLC** al: **1-877-689-2838** o escriba a **help@nuwavenow.com**.



Oven Pro Plus



Nutri-Pot™ 6Q
Pressure Cooker



Brio™
Digital Air Fryer

Nutri-Master™
Slow Juicer



Duralon® Healthy Ceramic
Non-Stick Cookware



PIC Gold
Precision Induction Cooktop



Flavor-Lockers™
with Vacuum-Seal Technology

nuwave®

— LIVE WELL FOR LESS —

www.NuWaveNow.com

FOR HOUSEHOLD USE ONLY

Model: 37001 120V, 60Hz, 1800 Watts

For patent information please go to: www.nuwarennow.com/legal/patent

Designed and Developed in U.S.A. by:

NuWave, LLC

1755 N. Butterfield Rd.

Libertyville, IL 60048, U.S.A.

Customer Service:

1-877-689-2838 • help@nuwarennow.com

Made in China

©2017 NuWave, LLC • All Rights Reserved.

Item No: BM37001

Rev: 03