



Features

- Integral flange.
- Right drain.
- Integral seat.
- One-piece construction.
- Coordinates with other products in the Memoirs collection.
- Coordinates with Choreograph™ walls.

Material

- Acrylic
- Reinforced with fiberglass (FRP).

Installation

- Alcove



Recommended Accessories

- K-1733 9 kW Steam Generator
- K-702206-G54 Frameless Sliding Shower Door
- K-702206-G73 Frameless Sliding Shower Door
- K-702206-L Frameless Sliding Shower Door
- K-702207-L Frameless Sliding Shower Door
- K-702217-L Frameless Sliding Shower Door
- K-705705-L Frameless Pivot Shower Door
- K-705711-L Frameless Pivot Shower Door
- K-705717-L Frameless Pivot Shower Door
- K-705723-L Frameless Pivot Shower Door
- K-705729-L Frameless Pivot Shower Door
- K-705741-L Frameless Pivot Shower Door
- K-705810-L Semi-Frameless Pivot Shower Door
- K-705811-L Semi-Frameless Pivot Shower Door
- K-705824-L Semi-Frameless Pivot Shower Door
- K-705825-L Semi-Frameless Pivot Shower Door
- K-706009-D3 Frameless Sliding Shower Door
- K-706009-L Frameless Sliding Shower Door
- K-706012-L Frameless Sliding Shower Door
- K-706013-L Frameless Sliding Shower Door
- K-706015-D3 Frameless Sliding Shower Door
- K-706015-L Frameless Sliding Shower Door
- K-706019-L Frameless Sliding Shower Door
- K-5526 7 kW Steam Generator
- K-9132 Shower Drain

Codes/Standards









ASME A112.19.1/CSA B45.2
CSA B45.5/IAPMO Z124
ASTM E162
ASTM E662
Greenguard UL 2818 - Gold

KOHLER® Plastic Baths and Receptors Lifetime Limited Warranty

See website for detailed warranty information.

Available Color/Finishes

Color tiles intended for reference only.

Color	Code	Description
	0	White
	96	Biscuit
	47	Almond
	NY	Dune
	95	Ice™ Grey
	G9	Sandbar
	K4	Cashmere
	58	Thunder™ Grey
	7	Black Black™

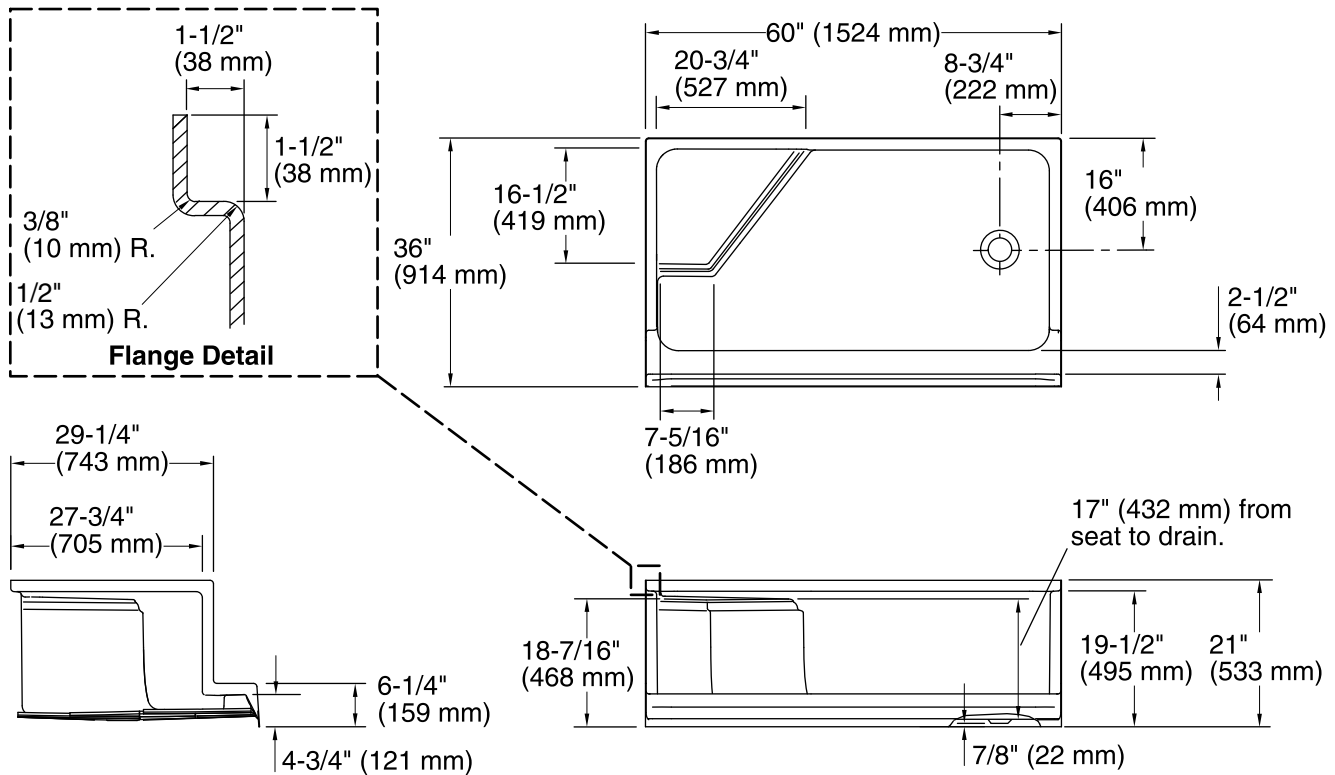

Technical Information

All product dimensions are nominal.

Installation:	3-Wall Alcove
Drain location:	Right
Weight:	94 lbs (42.6 kg)
Minimum floor load:	21 lbs/ft ² (102.5 kg/m ²)

Notes

- Measure your actual product for rough-in details. Install this product according to the installation instructions.
- Shimming may be required to level the fixture.
- Shimming may be required between the stud frame and the fixture.
- Stud opening tolerance is + 1/4" (6 mm), - 0" (0 mm).