

# Home Decorators

— Collection —

BF-23396 OXFORD COLLECTION 3 WOOD DOOR LOWBOY





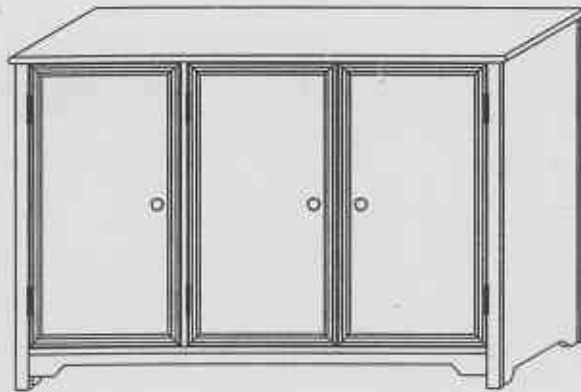



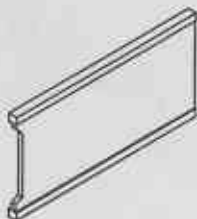
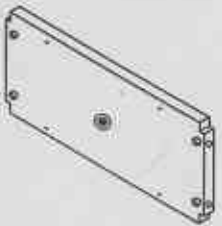

## ASSEMBLY INSTRUCTIONS

Made In China

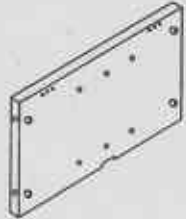

Thank you for purchasing this quality product. Be sure to check all packaging material carefully for small parts, which may have loose inside the carton during shipment. Once unpacked, compare all parts and hardware to the provided list to be sure all parts are present. If any parts or hardware are missing or damaged, please phone, e-mail or fax our Customer service Department. For speedy service, please provide your order number, item number and part number/letter of the part needed.

IMPORTANT NOTE: Follow instructions listed below in proper sequence as numbered to assure fast, easy and correct assembly.

PARTS LIST		
A    TOP PANEL-1PC	B    LEFT SIDE PANEL-1PC	C    RIGHT SIDE PANEL-1PC
D    BOTTOM PANEL-1PC	E    LEFT DOOR-2PCS	F    RIGHT DOOR-1PC
G    FRONT LOW PANEL-1PC	H    BACK LOW PANEL-1PC	I    BACK PANEL-2PCS
J    STAND PANEL-1PC	K    SHELF-1PC	L    SHELF-1PC

M



REAR PANEL GUIDE-1PC

N

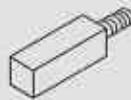

FEET-1PC

O



DOWELS-6PCS

P



KNOB-3PCS

Q



CAM-LOCKS-14PCS

R



CAM-BOLTS-14PCS

S



SHELF SUPPORTS-8PCS

T

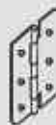

HINGES-6PCS

U

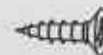

SCREWS-39PCS

V



SCREWS-3PCS

W



SCREWS-32PCS

X



SCREWS-3PCS

Y



SCREWS-4PCS

Z



LARGE MAGNETS-1PC

A1



CAM-TOOL-1PC

B1



FEMALE MAGNETS-3PCS

C1



SMALL MAGNETS-1PC

NOTE: • UPON OPENING THOROUGHLY CLEAN ALL WOODS SURFACES TO REMOVE DUST AND DIRT THAT MAY HAVE SETTLED ONTO FINISH DURING SHIPMENT. IN ORDER TO PREVENT DAMAGE DURING ASSEMBLY, PLEASE ASSEMBLE THIS ITEM WITH AT LEAST TWO PEOPLE.

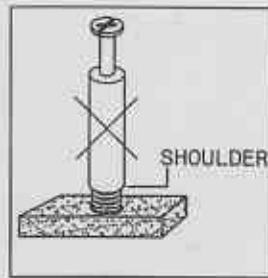
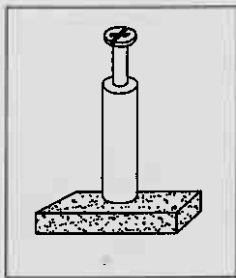

NOTE: TURN THE CAM-BOLT SCREWS UNTIL THEY ARE TIGHT, THE SHOULDER SHOULD BE AGAINST THE SURFACE OF THE PART.

## HOW TO USE THE CAM-TOOL

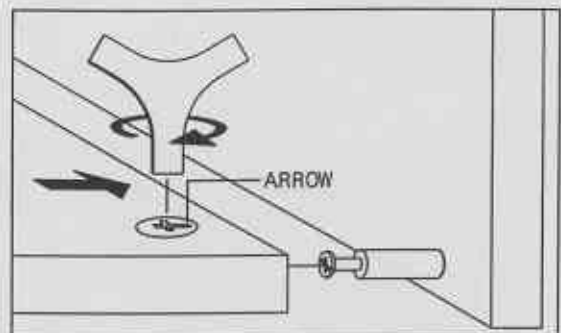
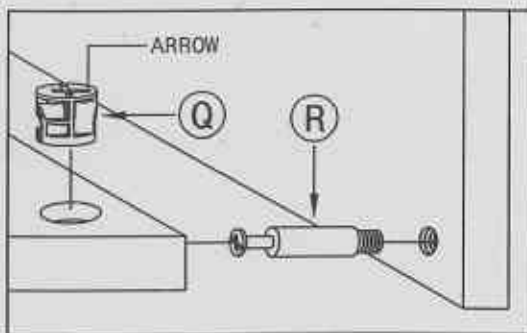

NOTE: • THE ARROWS ON THE HIDDEN CAM-LOCKS SHOULD POINT TO THE CAM-BOLTS

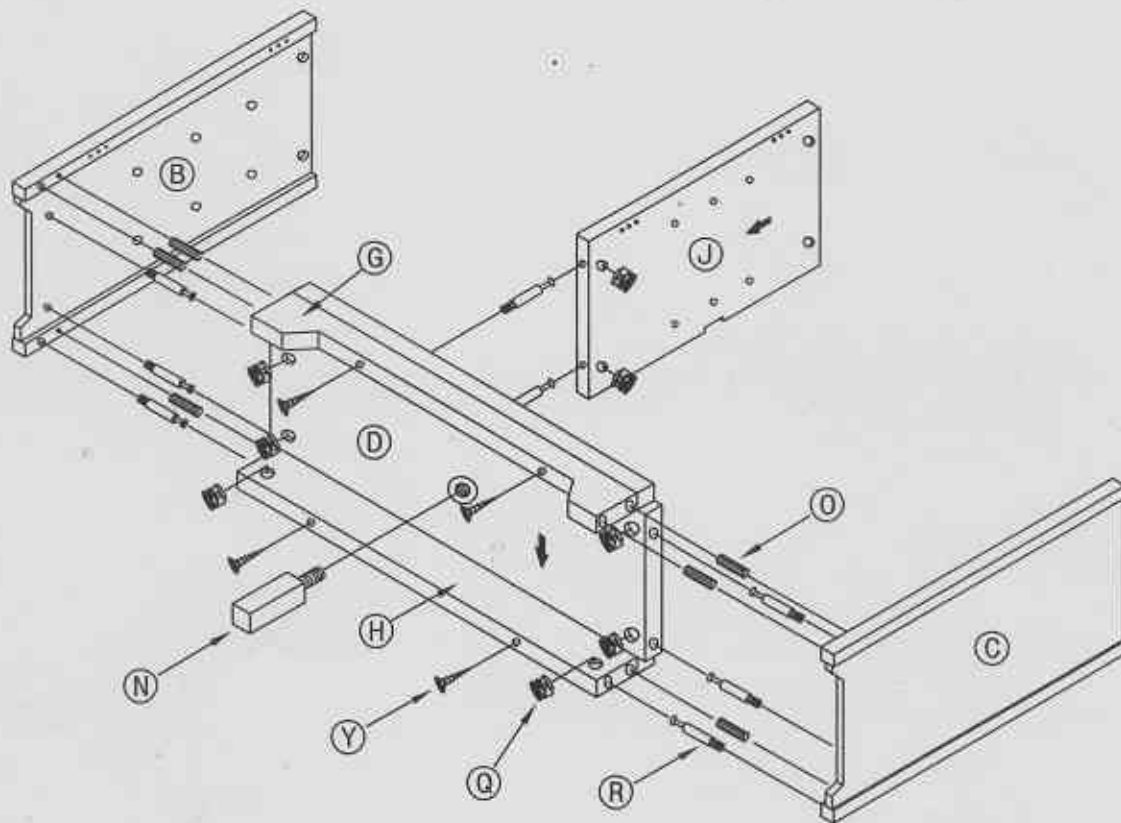

**1) .ASSEMBLE THE SIDE PANEL(B/C) .**

- ATTACH THE LOW PANEL(G/H)TO BOTTOM PANEL(D)USING 4 SCREWS(Y) .
- INSERT THE 6 DOWELS(O)INTO HOELS IN LOW PANEL(G/H) .
- ROTATE THE 8 CAM-BOLTS(R)INTO HOLES IN SIDE PANEL(B/C)AND BOTTOM PANEL(D) .
- PLACE CAM-BOLTS(R)INTO HOLES IN PANEL(D/H/J)AND ATTACH USING CAM-LOCKS(Q) .
- ROTATE THE FEET(N)INTO HOLES IN BOTTOM PANEL(D) .

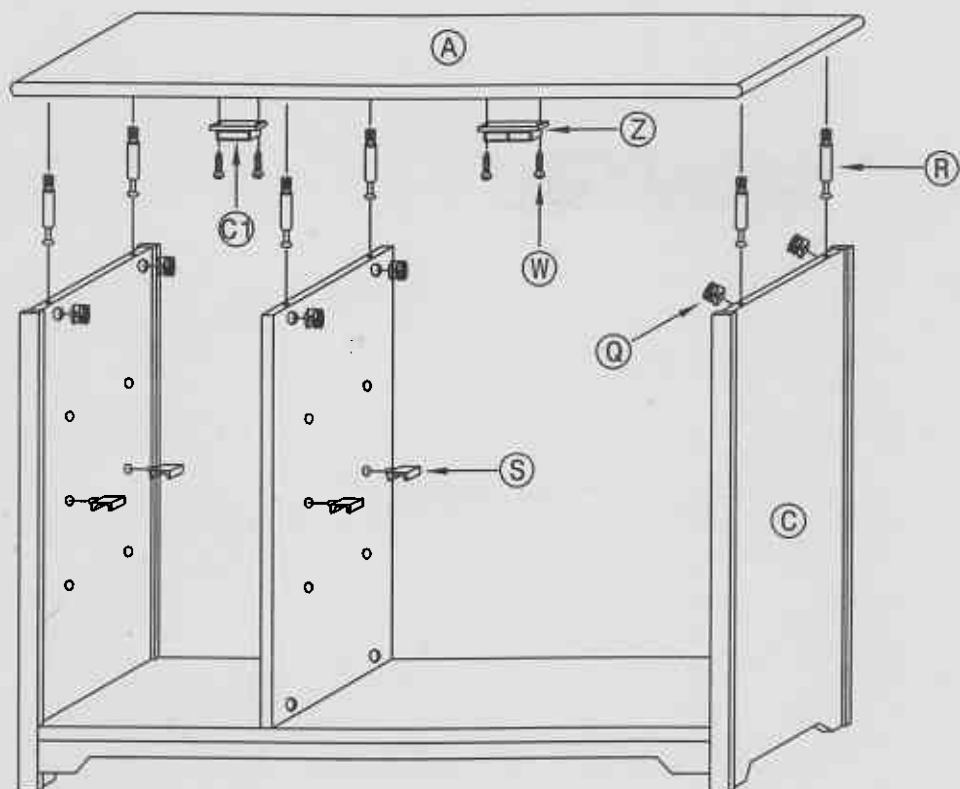

## 2) .ASSEMBLE TOP PANEL (A) .

- ROTATE THE 6 CAM-BOLTS(R) INTO HOLES IN TOP PANEL (A) .
- PLACE THE CAM-BOLTS(R) INTO HOLES IN PANEL (B/C/J) AND ATTACH USING CAM-LOCKS (Q) .
- ATTACH 2 MAGNETS (Z/C1) TO TOP PANEL (A) USING 4 SCREWS (W) .
- INSERT THE 8 SHELF SUPPORTS (S) INTO HOLES IN SIDE/STAND PANEL (B/C/J) .

NOTE:(Attach the another doors(E/F)by the same method as the left door(E)with screws and hinges).

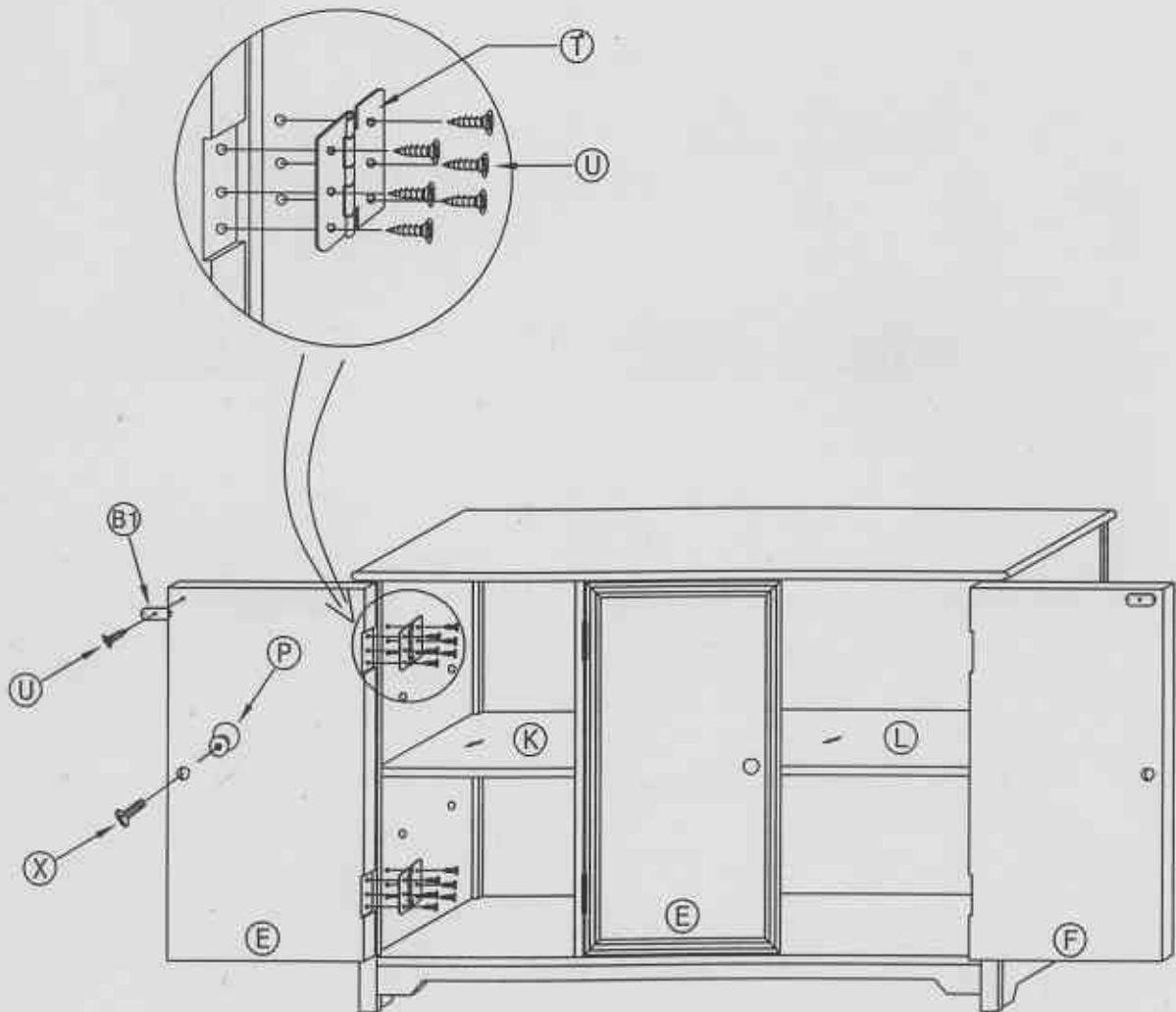

### 3) .ASSEMBLE THE DOORS(E/F) .

- ATTACH THE KNOB(P)TO LEFT DOOR(E)USING SCREWS(X) .
- ATTACH THE FEMALE MAGNETS(B1)TO LEFT DOOR(E)USING SCREWS(U) .
- ATTACH HINGE(T)TO LEFT DOOR(E)AND LEFT SIDE PANEL(B)USING 12 SCREWS(U) .
- PUT THE SHELF(K/L)ONTO THE SHELF SUPPORTS(S) .

Note: Before you assemble the back panel, please make sure the doors have an even gap around them. If uneven, shift the unit left or right until the doors are evenly spaced.

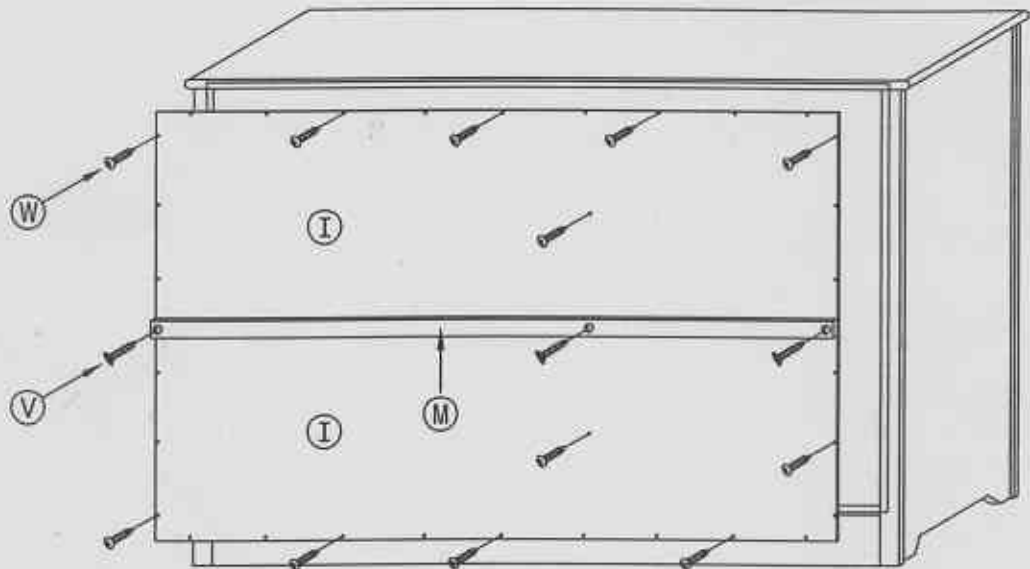

**4) .ASSEMBLE BACK PANEL (I) .**

- INSERT THE BACK PANEL (I) INTO SLOT IN REAR PANEL GUIDE (M) .
- ATTACH THE BACK PANEL (I) AND REAR PANEL GUIDE (M) USING SCREWS (W/V) .