

OWNER'S MANUAL



PORTABLE TABLETOP GRILL OR SIDE FIRE BOX

Model #92424



**Keep your receipt with
this manual for Warranty.**

**CUSTOMER SERVICE
1-912-638-4724
Service@CharGriller.com**



**HOW TO USE
THE SIDE FIRE BOX**

Contents of this manual are Trademarked and Copyrighted by Char-Griller® | A&J Manufacturing
Using the information contained in this manual without consent of Char-Griller® and/or A&J Manufacturing is strictly prohibited.



TABLE OF CONTENTS

Safety Warnings & Warranty.....	A-1
Assembly Instructions.....	B-1
Portable Table Top Grill.....	B-4
Side Fire Box.....	B-10
Product Usage.....	C-1
Accessories.....	E-1

IMPORTANT SAFETY WARNINGS

READ ALL SAFETY WARNINGS AND INSTRUCTIONS CAREFULLY BEFORE ASSEMBLING AND OPERATING YOUR GRILL

Read the following instructions carefully and be sure your grill is properly assembled, installed, and maintained. Failure to follow these instructions may result in serious bodily injury and/or property damage. If you have any questions concerning assembly or operation, call 912-638-4724.

- Grill is for use outdoors and in well-ventilated areas, only.
- Use caution when assembling and operating your grill to avoid scrapes or cuts from sharp edges
- Do not use lighter fluid, gasoline, kerosene, alcohol or other accelerant for lighting charcoal due to flammability, risk of bodily injury and potential to leave a distasteful flavor in your food.
- Do not leave a lit grill unattended. Keep children and pets away from grill at all times.
- Do not use grill in high winds.
- Use caution when moving grill to prevent strains.
- The use of alcohol, prescription or non-prescription drugs may impair the operator's ability to properly assemble or safely operate the grill.
- Use grill at least 3 ft. from any wall or surface. Maintain 10 ft. clearance to objects that can catch fire or sources of ignition such as pilot lights on water heaters, live electrical appliances, etc.
- When adding charcoal and/or wood, use extreme caution.
- Never move grill when it is in use or when it contains hot coals or ashes.
- Do not use grill for indoor cooking or heating. TOXIC fumes can accumulate and cause asphyxiation.
- Do not use in or on boats or recreational vehicles.
- Make sure to empty grease can after every use once completely cooled.
- Do not place grill near flammable liquids, gases, or where flammable vapors may be present.
- When cooking with oil/grease, do not allow the oil/grease to exceed 350°F (177°C). Do not store or use extra cooking oil in the vicinity of this or any other grill.
- Use caution since flames can flare-up when fresh air suddenly comes in contact with fire.



WARNING: FUELS USED IN WOOD OR CHARCOAL BURNING APPLIANCES, AND THE PRODUCTS OF COMBUSTION OF SUCH FUELS, CAN EXPOSE YOU TO CHEMICALS INCLUDING CARBON BLACK, WHICH IS KNOWN TO THE STATE OF CALIFORNIA TO CAUSE CANCER, AND CARBON MONOXIDE, WHICH IS KNOWN TO THE STATE OF CALIFORNIA TO CAUSE BIRTH DEFECTS OR OTHER REPRODUCTIVE HARM. *For more information go to:* www.P65Warnings.ca.gov.

ADVERTENCIA: LOS COMBUSTIBLES USADOS EN EQUIPOS PARA QUEMAR MADERA O CARBÓN, ASÍ COMO LOS PRODUCTOS DE TAL COMBUSTIÓN, PUEDEN EXPONERTE A SUSTANCIAS QUÍMICAS, ENTRE ELLAS EL NEGRO DE HUMO Y EL MONÓXIDO DE CARBONO, QUE EL ESTADO DE CALIFORNIA RECONOCE COMO CAUSA, RESPECTIVAMENTE, DE CÁNCER Y DE MALFORMACIONES CONGÉNITAS Y OTROS DAÑOS AL SISTEMA REPRODUCTOR. *Para más información, visite www.P65Warnings.ca.gov*



IMPORTANT SAFETY WARNINGS

(Continued)

- Do not lean over an open grill and be mindful of hands/fingers near the edge of the cooking area.
- When opening the lid, keep hands, face, and body safe from hot steam and flame flare-ups.
- **WARNING:** To avoid injuries, gloves or other protective articles should be used when operating the grill.
- Do not exceed a temperature of 500°F.
- Do not allow charcoal and/ or wood to rest on the walls of grill. Doing so will greatly reduce the life of the grill.
- Always wear grill gloves to protect hands from burns. Avoid touching hot surfaces.
- **CAUTION:** Exposed metal dampers on air vents and/or metal handles are hot during usage. Again, always wear grill gloves when adjusting air flow to protect hands from burns.
- Do not alter this grill in any manner.
- When opening lid, make sure it is pushed all the way back so it rests against the lid support brackets. Use extreme caution as hood could fall back to a closed position and cause bodily injury.
- Close lid and all dampers to help suffocate flame.
- Always hold an open lid from the handle to prevent it from closing unexpectedly.
- Never leave coals and ashes unattended. Before grill can be left unattended, coals and ashes must be removed. Use caution to protect yourself and property.
- Carefully place remaining coals and ashes in a noncombustible metal container and saturate completely with water. Allow coals and water to remain in a metal container for 24 hours prior to disposing.
- To protect against bacteria that could cause illness, keep all meats refrigerated and thaw in refrigerator or microwave. Keep raw meats separate from other foods, and wash everything that comes in contact with raw meat.
- Cook meat thoroughly, and refrigerate leftovers immediately.
- Use a calibrated food thermometer and the USDA guidelines to ensure that meat, poultry, seafood, and other cooked foods reach a safe minimum internal temperature.
- Always have a fire extinguisher near at all times. Maintain and check your fire extinguisher regularly.

THESE WARNINGS ALSO APPLY TO THE SIDE FIRE BOX.

*** STOP! CALL FIRST! ***

Do NOT Return Product to Store.

This grill has been made according to the highest of quality standards. If you have any questions not addressed in this manual or if you need parts please call our Customer Service Department at 1-912-638-4724 (USA) or email Char-Griller® at: Service@CharGriller.com and have your serial number handy.

REGISTER YOUR GRILL:

To take full advantage of the Char-Griller® warranty be sure to register your grill by visiting www.CharGriller.com/Register or calling Customer Service at 1-912-638-4724.

Registration provides important protections:

1. Register your grill today to activate your warranty and get exclusive access to product developments, updates, and recipes.
2. This allows us to help you get warranted parts to your quickly and provide enhanced customer service.

NOTE: You will need your model #, serial number, and a copy of the original sales receipt when registering.



Document Your Serial Number HERE:

(Serial number is located on the back of the griddle body or on the leg.)

(SERIAL #)

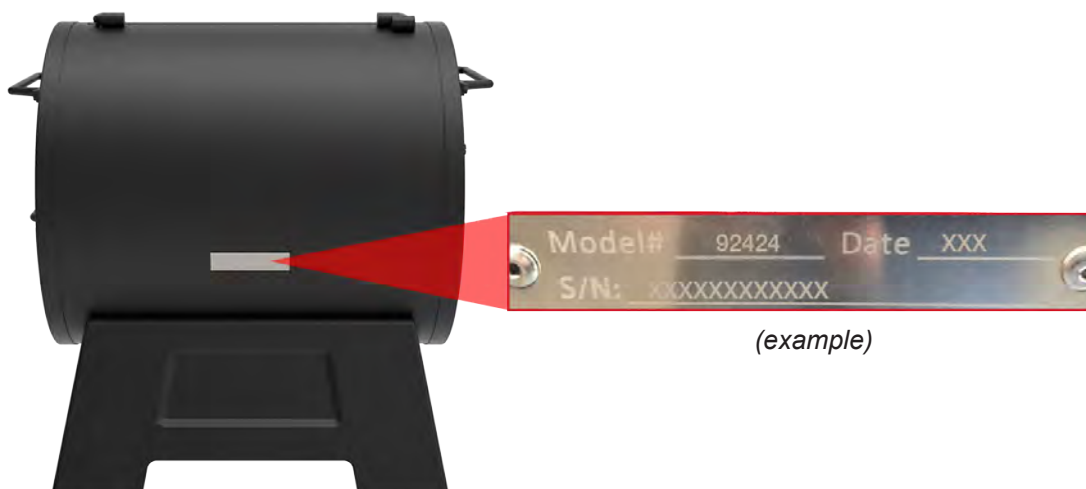



WARRANTY INFORMATION

A COPY OF THE DATED PROOF OF PURCHASE (RECEIPT) IS REQUIRED WHEN REGISTERING OR SUBMITTING A WARRANTY* CLAIM. PLEASE RETAIN A COPY OF THE RECEIPT FOR YOUR RECORDS.

Char-Griller® will replace any defective part of its grillers/smokers, under warranty, as outlined below.

PLEASE READ THIS INFORMATION IN DETAIL AND IF YOU HAVE ANY QUESTIONS CONTACT CUSTOMER SERVICE AT 912-638-4724 OR SERVICE@CHARGRILLER.COM.

Charcoal / Pellet / Kamado Grills	
Grill - Hood AND Bottom (excludes removable Ash Pan)	5 years from date of purchase for rust through / burn through
Ash Pan AND Defective Parts	1 year from date of purchase
Gas Grills	
Grill Hood (TOP half) AND Main Burner Tubes (excludes Side Burner)	5 years from date of purchase for rust through / burn through
Grill Body (BOTTOM half) AND Side Burner AND Defective Parts	1 year from date of purchase
Dual Fuel Grills (Gas & Charcoal)	
Charcoal Grill - Hood AND Bottom AND Gas Grill Hood (TOP half) AND Main Burner Tubes (excludes Ash Pan and Side Burner)	5 years from date of purchase for rust through / burn through
Ash Pan AND Defective Parts AND Gas Grill Body (BOTTOM half) AND Side Burner	1 year from date of purchase
Parts, Accessories, and Grill Covers	
	1 year from date of purchase (seam tears only for covers)

SURFACE RUST IS NOT CONSIDERED A MANUFACTURING OR MATERIALS DEFECT

Char-Griller® grills are made of steel and if exposed to the elements rust will occur naturally. Please refer to the section entitled, "Usage" to review how to care for your grill properly.

Surface issues such as scratches, dents, corrosion or discoloring by heat, abrasive and chemical clearers, surface rust or the discoloration of steel surfaces are NOT covered under these warranties.

Warranties are for the replacement of defective parts only. Char-Griller® is not responsible for damage resulting from accident, alteration, misuse, abuse, hostile environments, improper installation, and installation not in accordance with local codes of service of unit.

Excluded Under ALL Warranties

Paint; Surface Rust; Heat Damage; Incorrect Parts ordered by customer, including shipping; Worn Parts; Missing or damaged parts not reported within two (2) months of purchase date; Defective parts not reported within one (1) year of purchase date; Fading grill cover.

*NOTE: For warranty claims, photos and prepaid return of the item in question may be required. Misuse, abuse or commercial use nullifies all warranties.

ASSEMBLY INSTRUCTIONS

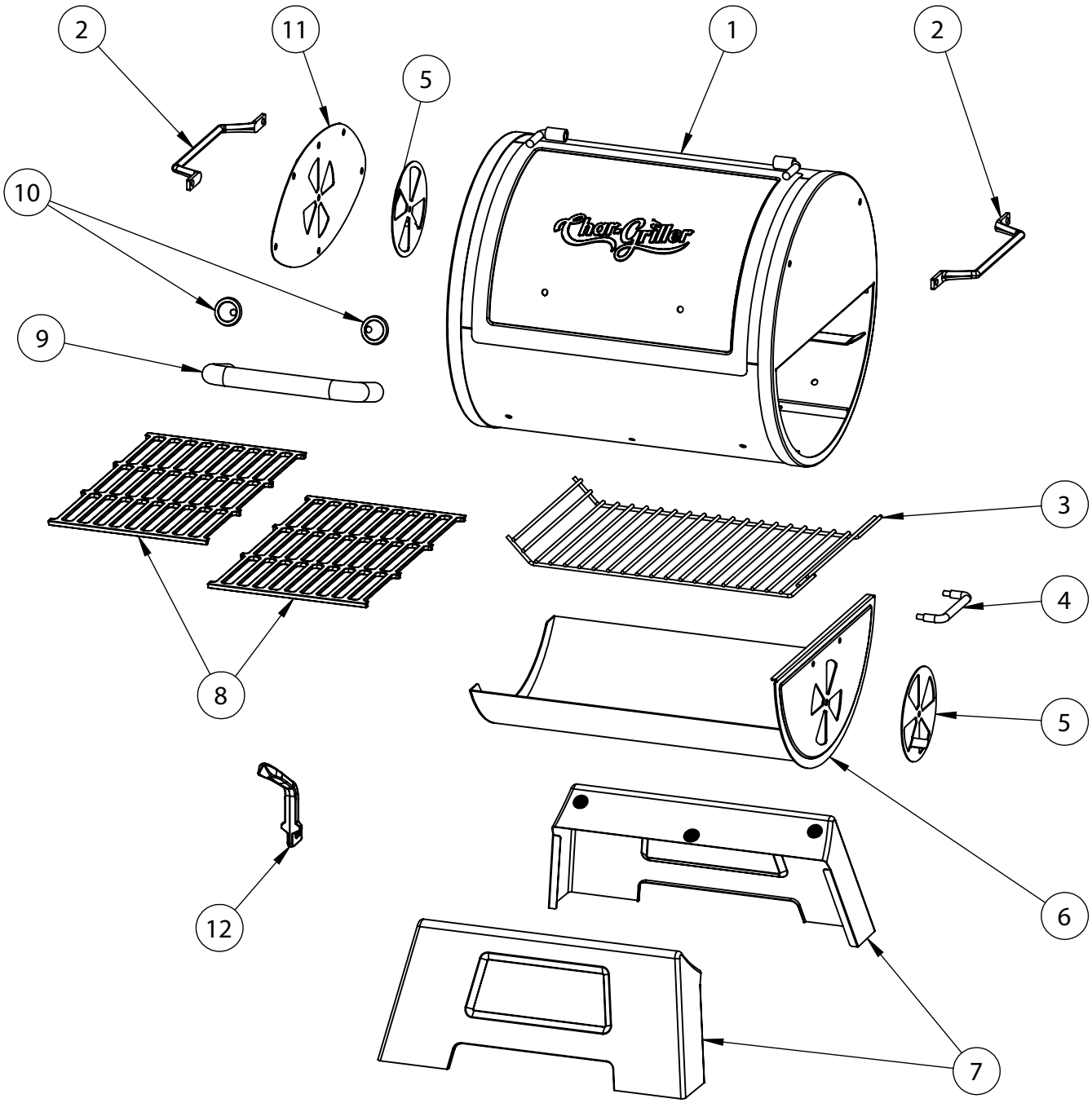



PARTS LIST

Item	QTY	Part Name
1	1	GRILL BODY
2	2	SIDE HANDLE
3	1	CHARCOAL GRATE
4	1	DRAWER HANDLE
5	2	DAMPER CIRCLE
6	1	DRAWER
7	2	LEGS
8	2	COOKING GRATE
9	1	HOOD HANDLE (HARDWARE INCLUDED)
10	2	HOOD HANDLE BEZEL
11	1	FILLER PLATE
12	1	GRATE LIFTER











HARDWARE NEEDED

PORTABLE TABLE TOP GRILL

Tools Needed: Hammer, Phillips Head Screwdriver, Pliers, and a 7/16" Nut Driver.

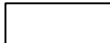
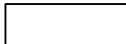
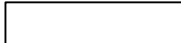
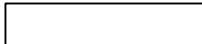
****NOTE: DO NOT fully tighten any bolts until instructed to do so. Tightening too soon may prohibit parts from fitting together. All hex nuts should be on the inside of the grill unless stated otherwise. Unpack all contents in a well cleared and padded area.****

Estimated Time: 30 minutes

Part No.	Description	Photo	QTY
A	1/2" HEX BOLT		10
B	3/4" HEX BOLT		2
C	HEX NUT		8
D	LOCK WASHER		4
E	FLAT WASHER		4
F	24 MM SPACER TUBE		2
G	28 MM SPACER TUBE		2
H	32 MM SPACER TUBE		2
I	46 MM SPACER TUBE		2
J	51.2 MM SPACER TUBE		2
K	82 MM SPACER TUBE		2
L	2 1/2" HEX BOLT		2
M	5 1/4" HEX BOLT		2

Hardware Pack #551166



ASSEMBLY INSTRUCTIONS

PORTABLE TABLE TOP GRILL

STEP 1

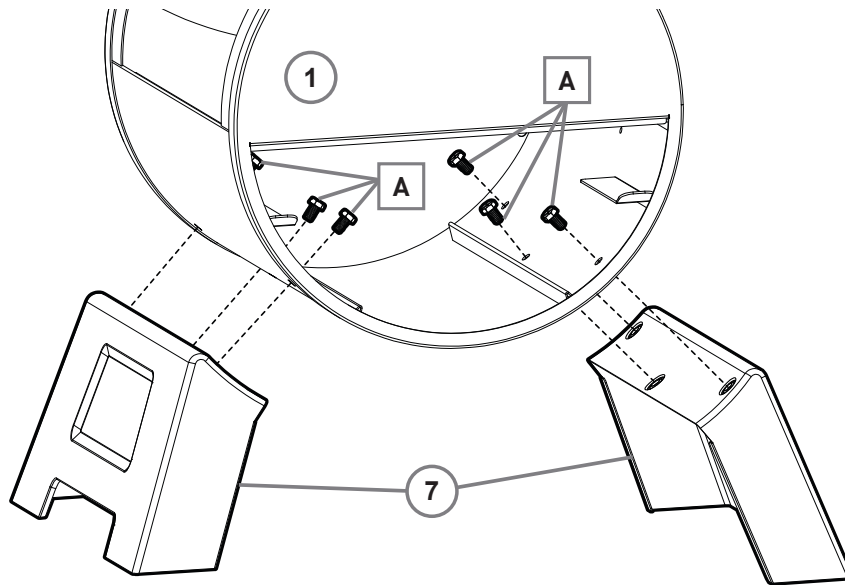

STEP 2

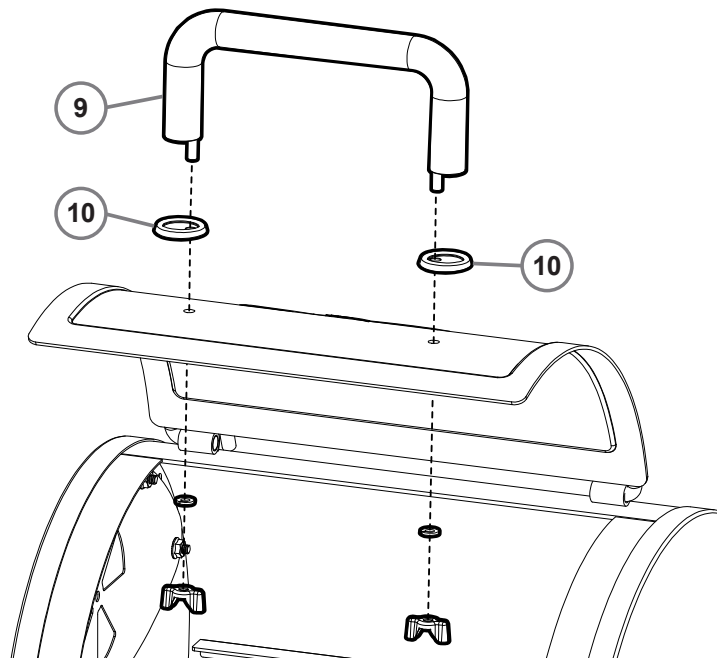

STEP 3

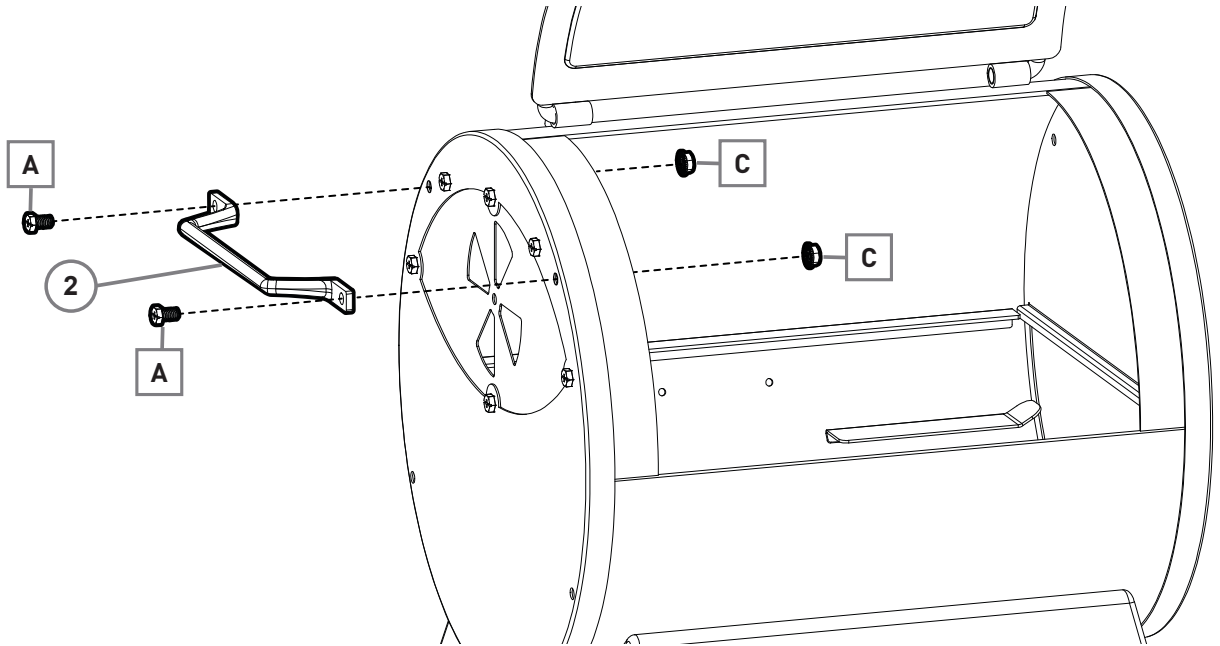
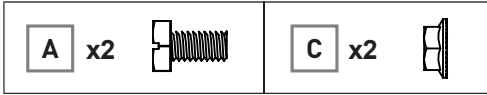

STEP 4

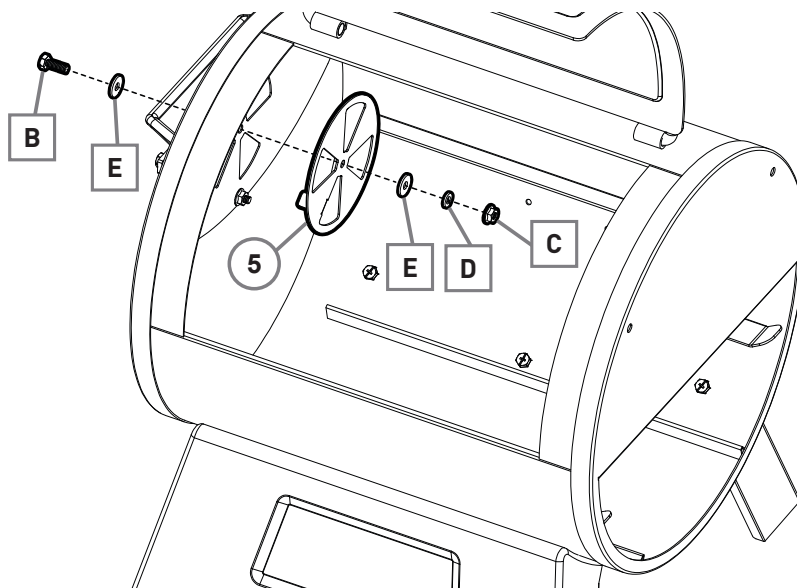
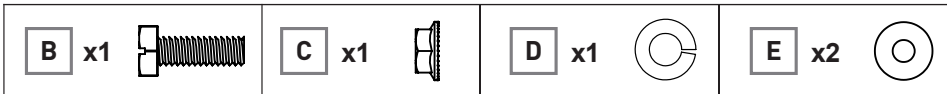



STEP 5

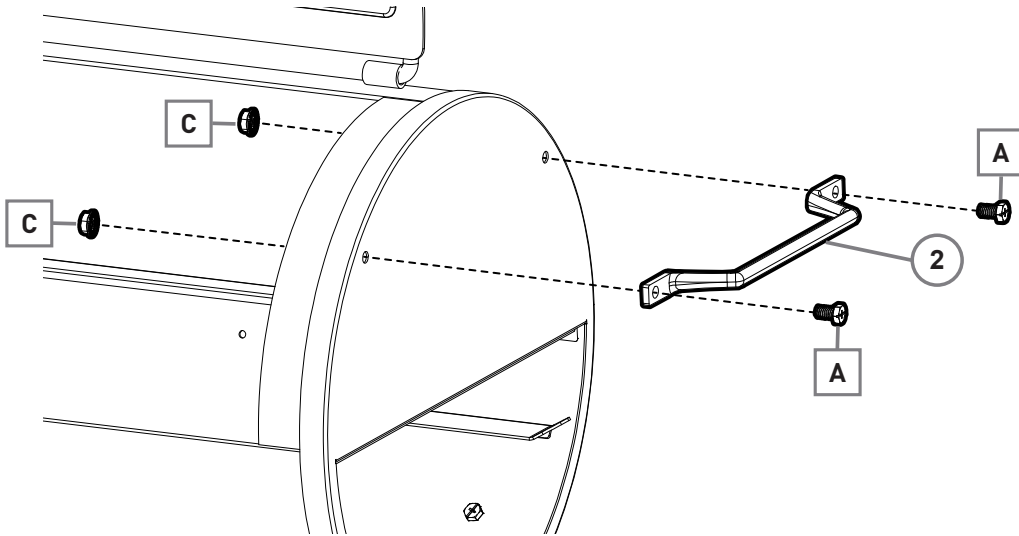
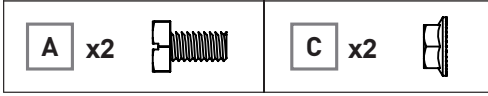

STEP 6

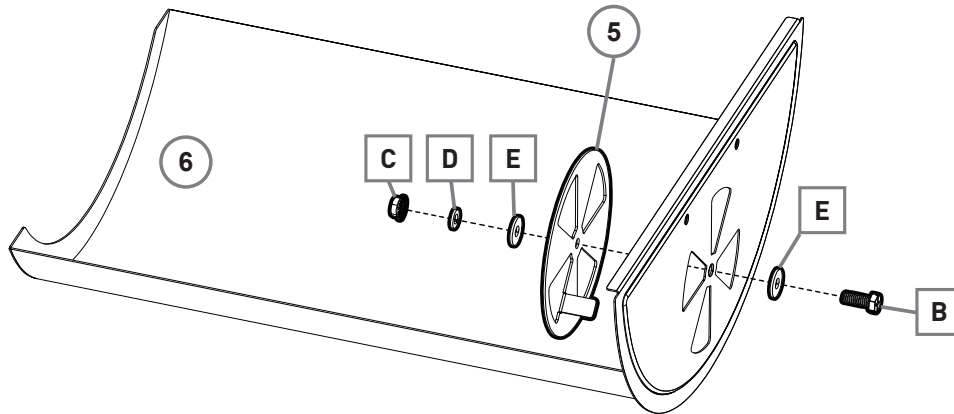
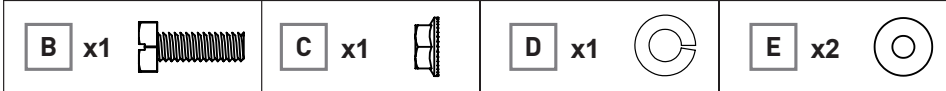

STEP 7

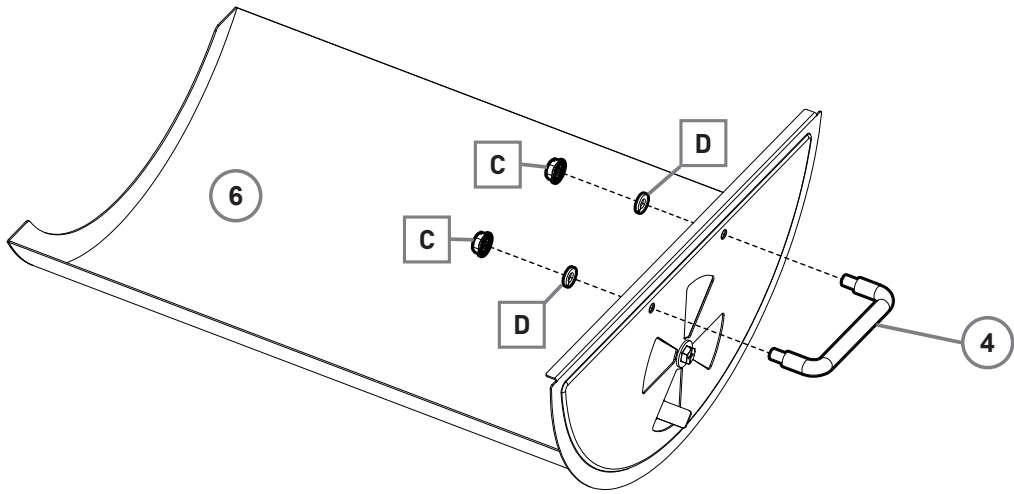
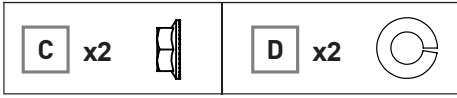

STEP 8

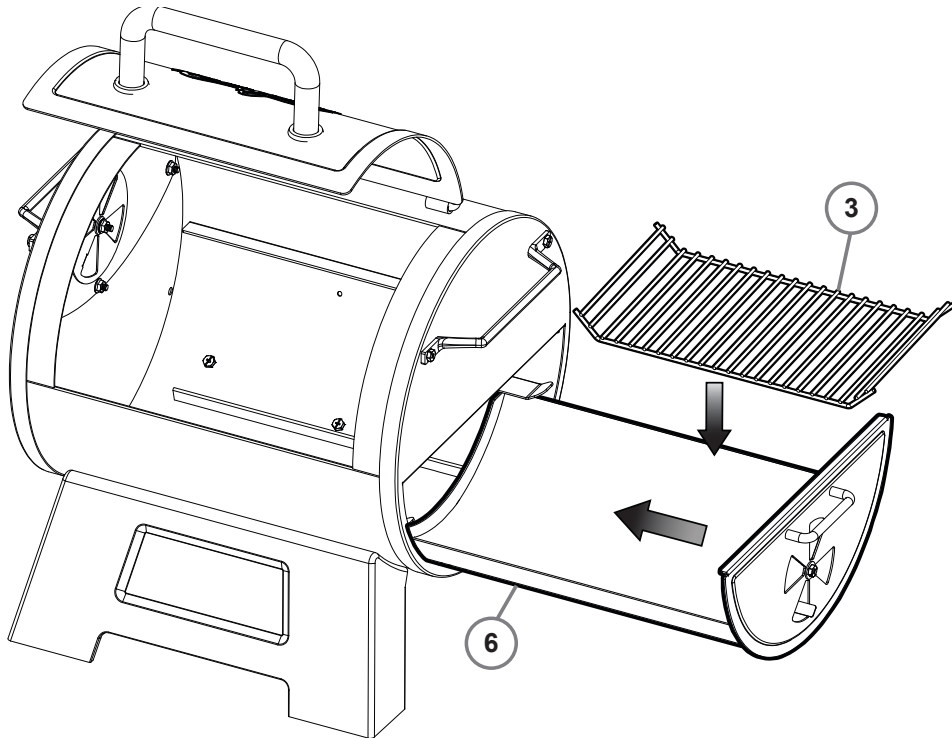



STEP 9

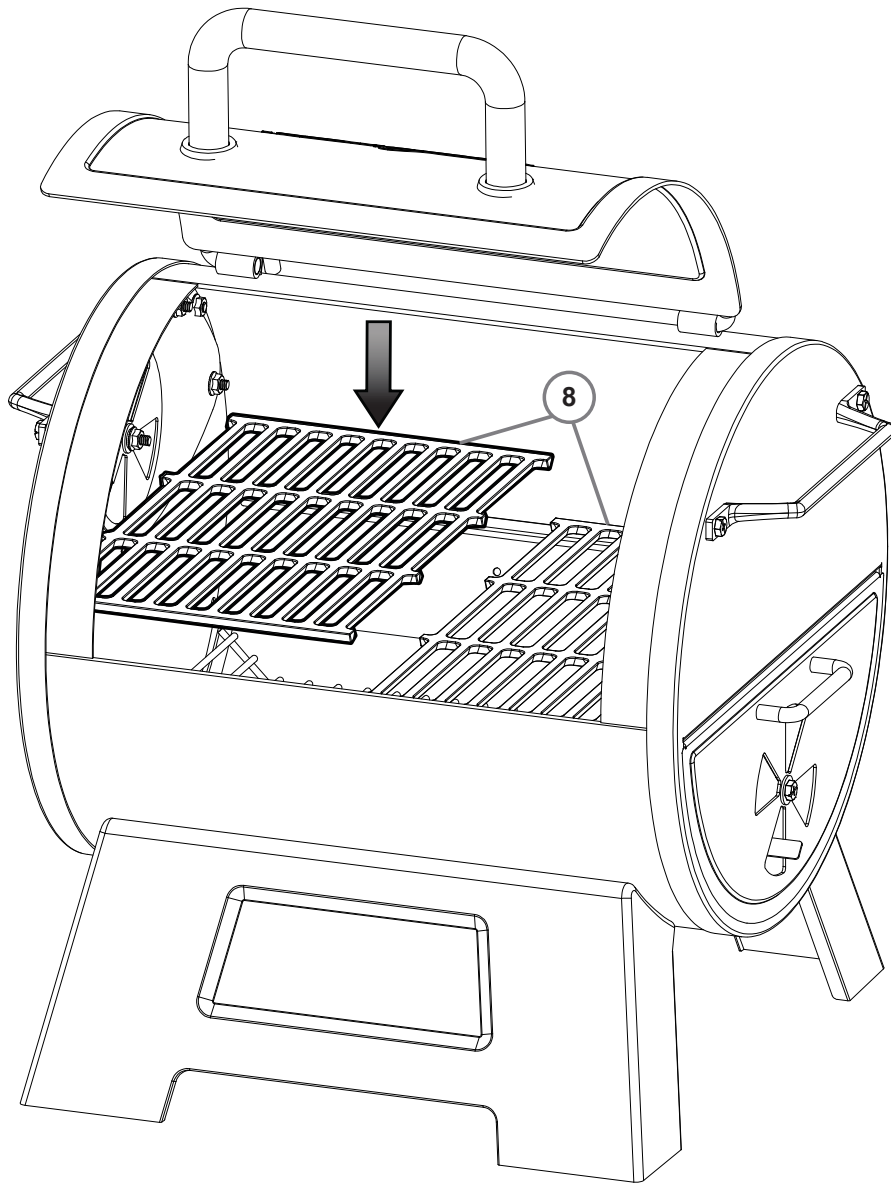

STEP 10

To ensure sturdy assembly, tighten all NUTS and BOLTS.

FULLY ASSEMBLED





SPACER TUBE SIZES FOR SIDE FIRE BOX ATTACHMENT*

Different grill models require unique spacer tubes. Please use this diagram to determine which spacer tube is appropriate for your specific grill model.

***2175, 2190, 2197 do not need spacer tubes**

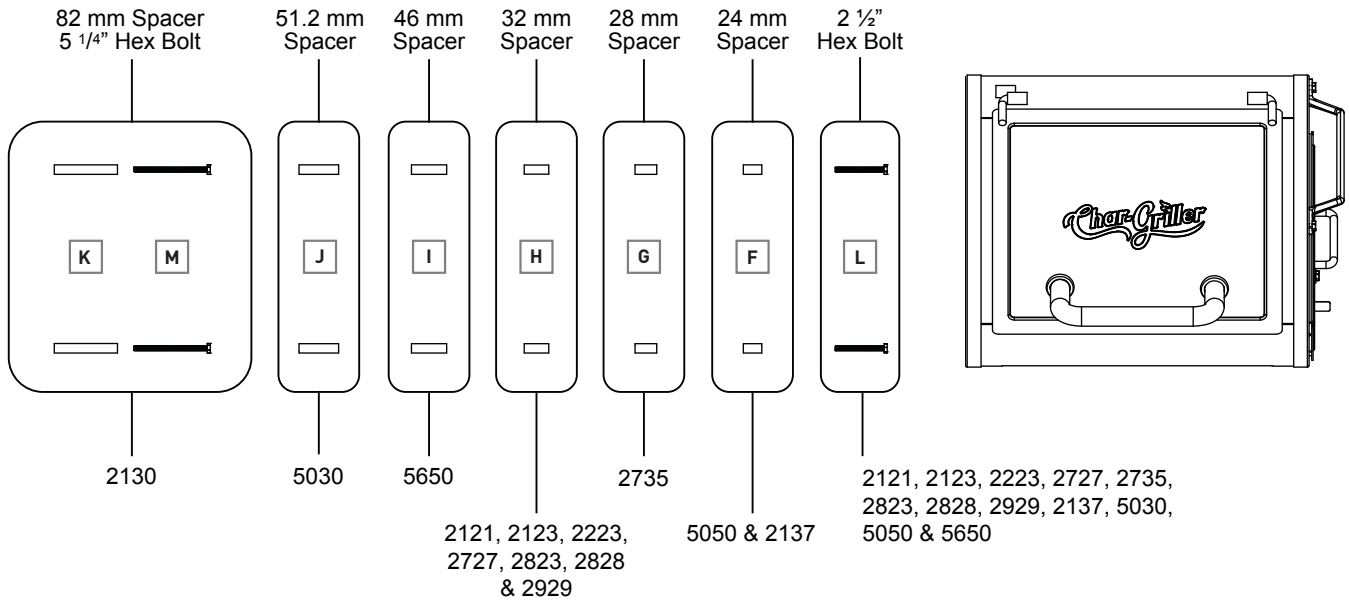

SPACER TUBE SIZE CHART

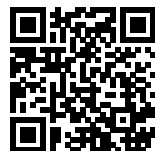
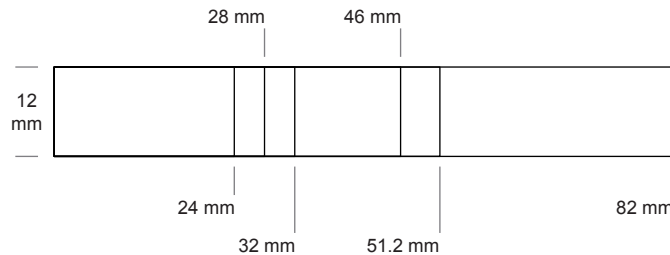

**SCAN & LEARN:
INSTALLING
THE SIDE FIRE BOX**

















HARDWARE NEEDED

SIDE FIRE BOX ATTACHMENT

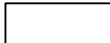
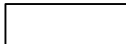
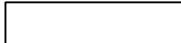
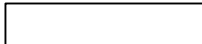
Tools Needed: Hammer, Phillips Head Screwdriver, Pliers, and a 7/16" Nut Driver.

****NOTE: DO NOT fully tighten any bolts until instructed to do so. Tightening too soon may prohibit parts from fitting together. All hex nuts should be on the inside of the grill unless stated otherwise. Unpack all contents in a well cleared and padded area.****

Estimated Time: 30 minutes

Part No.	Description	Photo	QTY
A	1/2" HEX BOLT	 	10
B	3/4" HEX BOLT	 	2
C	HEX NUT	 	8
D	LOCK WASHER	 	4
E	FLAT WASHER	 	4
F	24 MM SPACER TUBE		2
G	28 MM SPACER TUBE		2
H	32 MM SPACER TUBE		2
I	46 MM SPACER TUBE		2
J	51.2 MM SPACER TUBE		2
K	82 MM SPACER TUBE		2
L	2 1/2" HEX BOLT	 	2
M	5 1/4" HEX BOLT	 	2

Hardware Pack #551166



ASSEMBLY INSTRUCTIONS

SIDE FIRE BOX

STEP 1A

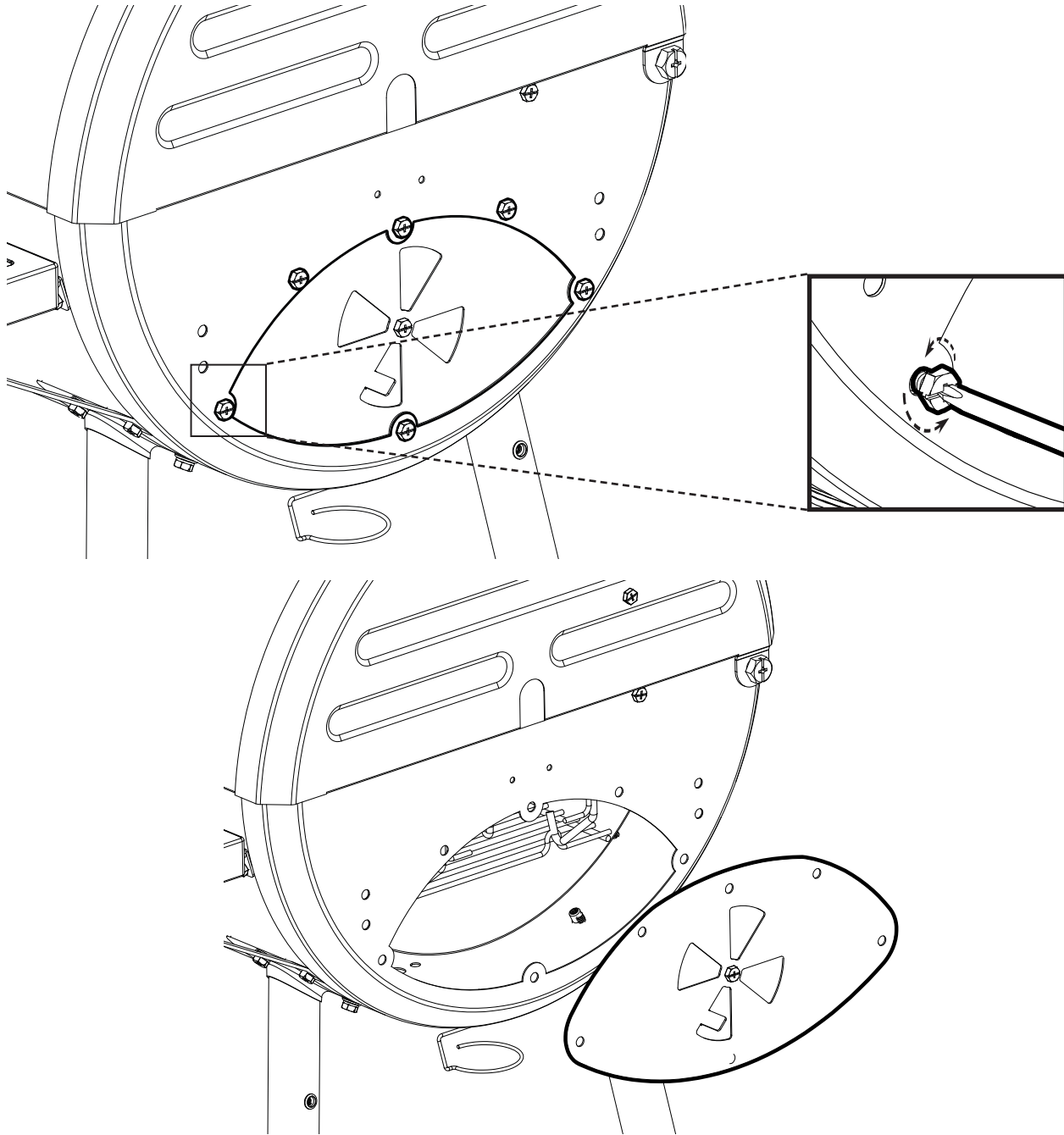



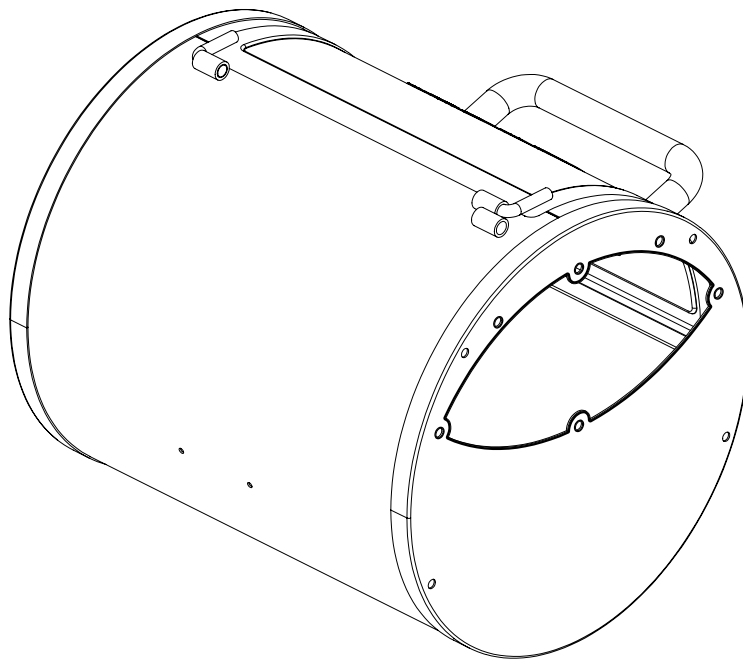
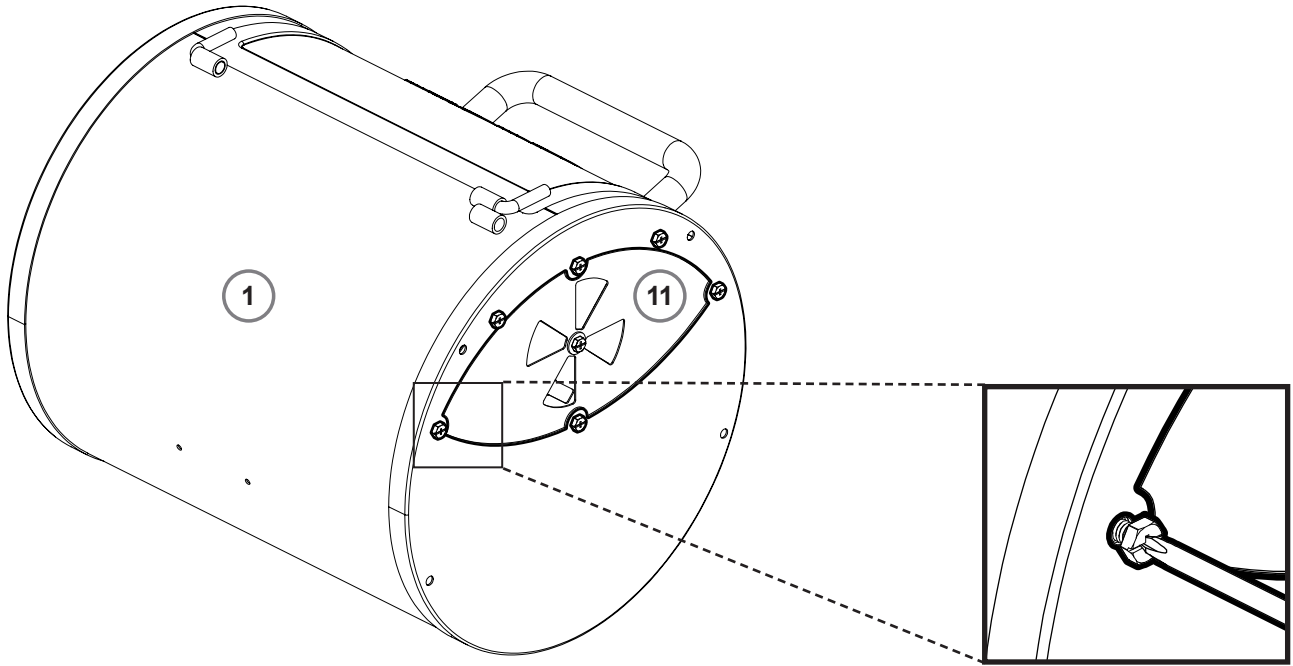

STEP 1B







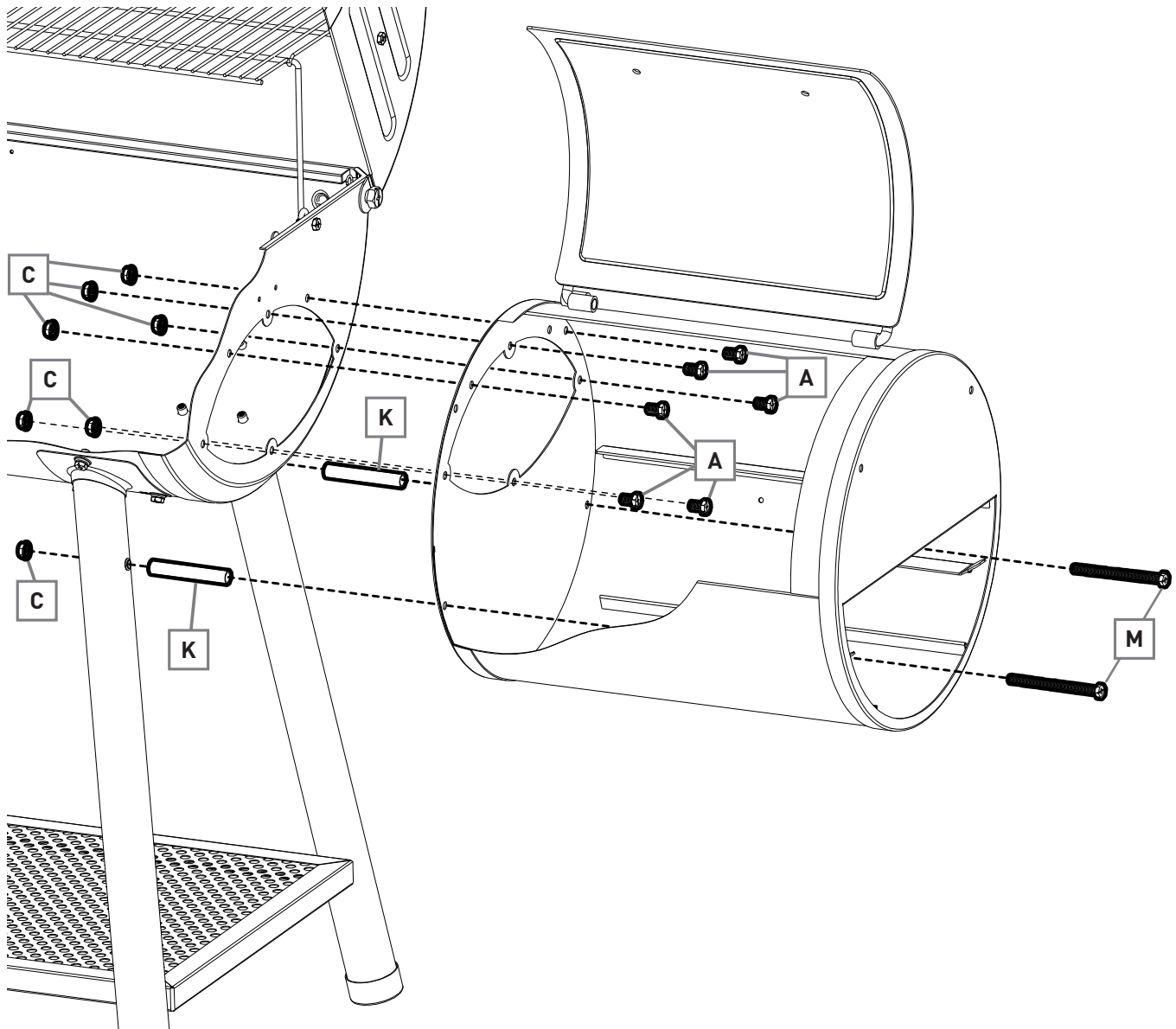

STEP 2: ATTACHING THE SIDE FIRE BOX (BLAZER™ #2130)

A x6 	C x8 	M x2 
K x2 		



STEP 2: ATTACHING THE SIDE FIRE BOX (ALL OTHER GRILL MODELS)

A x6 	C x8 	L x2 
SPACER TUBE x2 	Refer to Page B-10 for the intended spacer tube for your specific grill model	

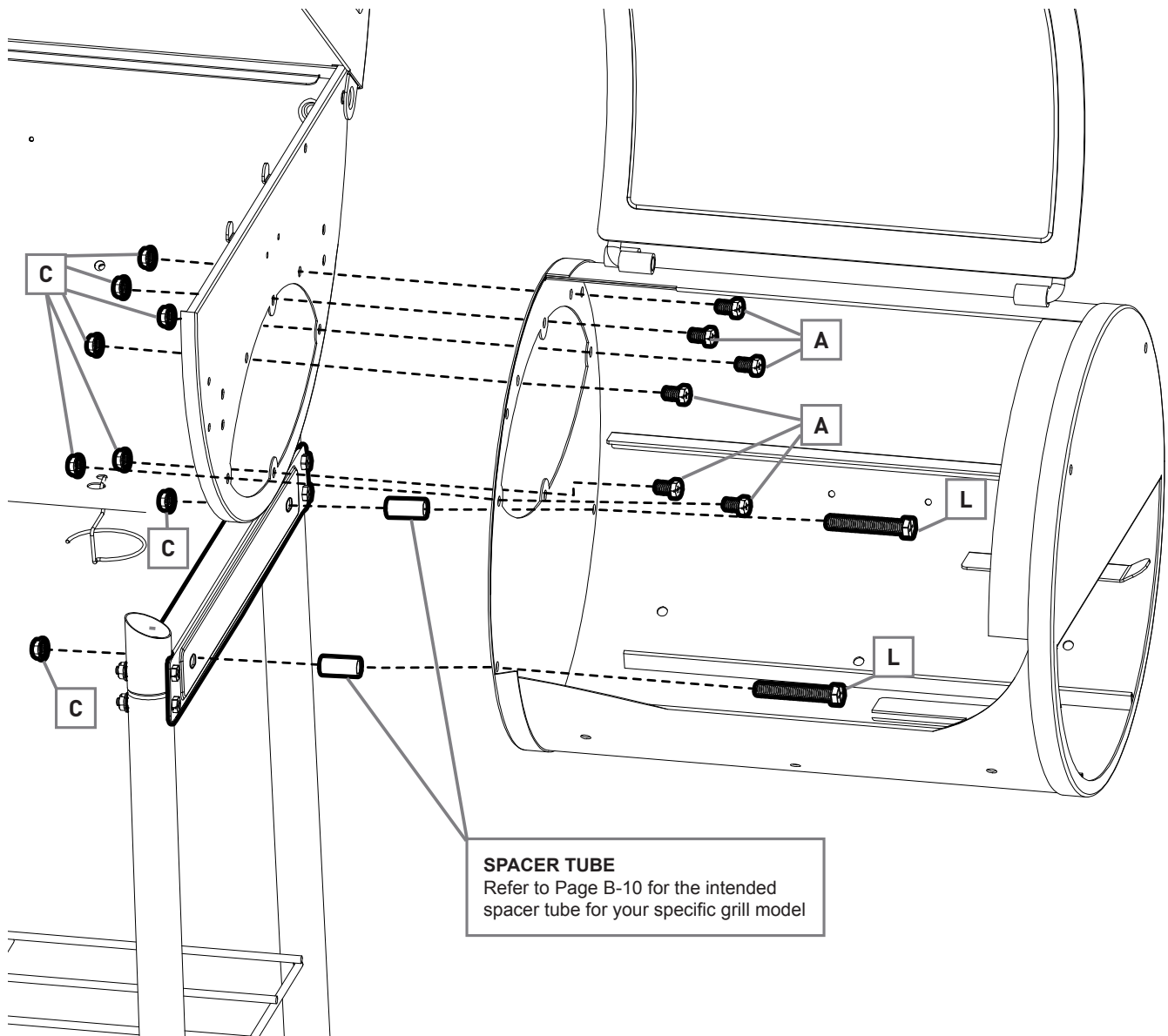



STEP 3

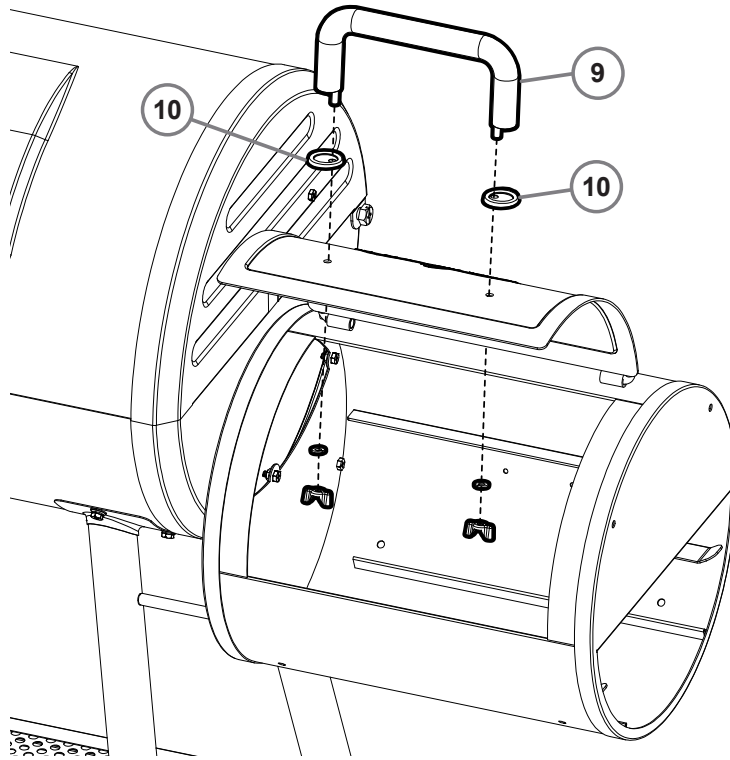

STEP 4

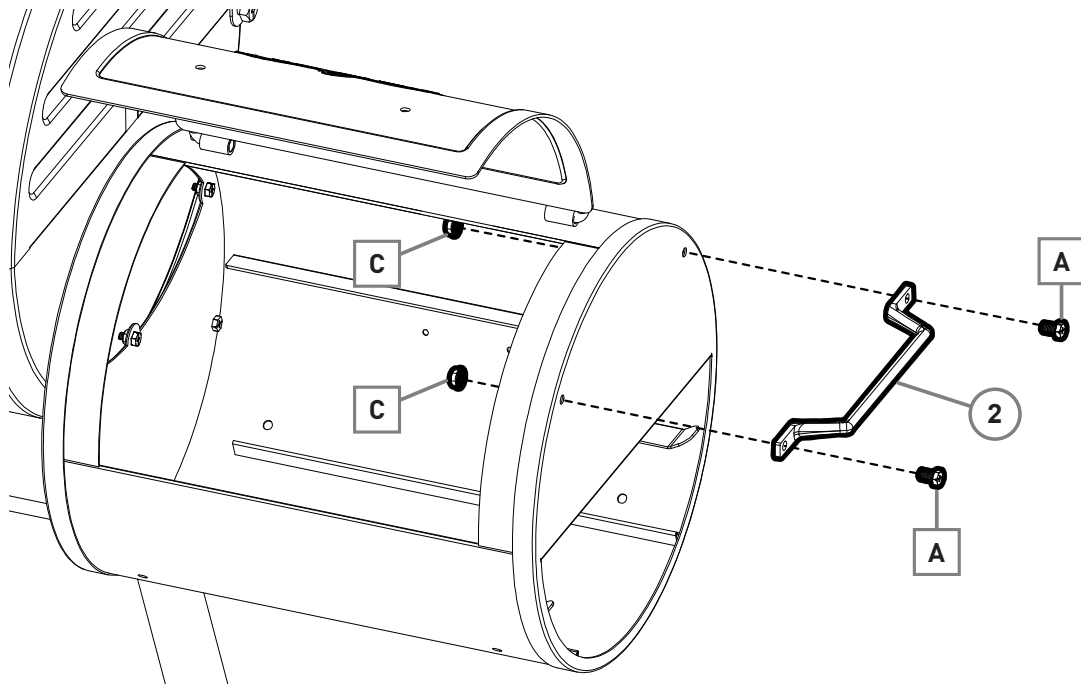
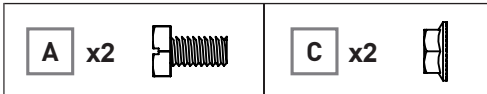

STEP 5

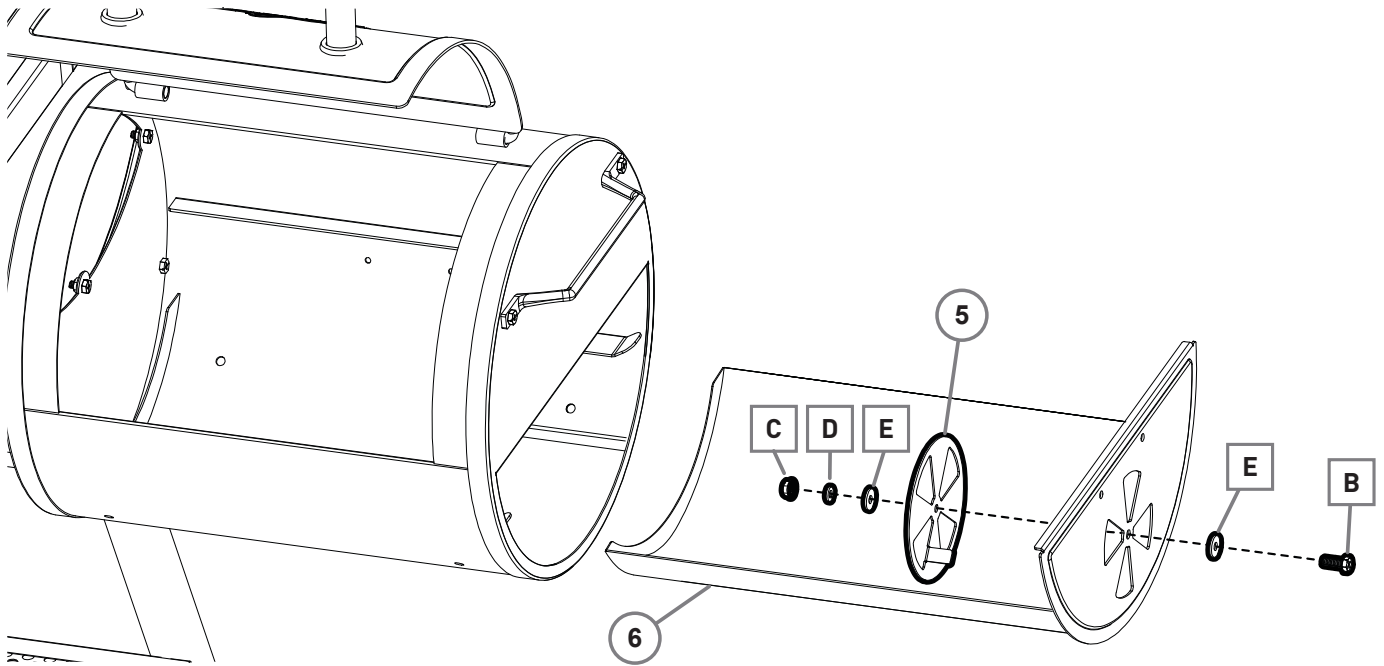
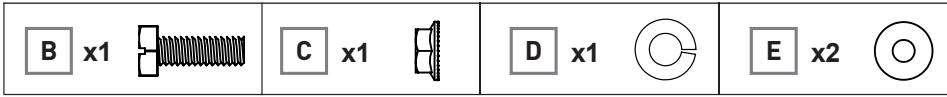

STEP 6

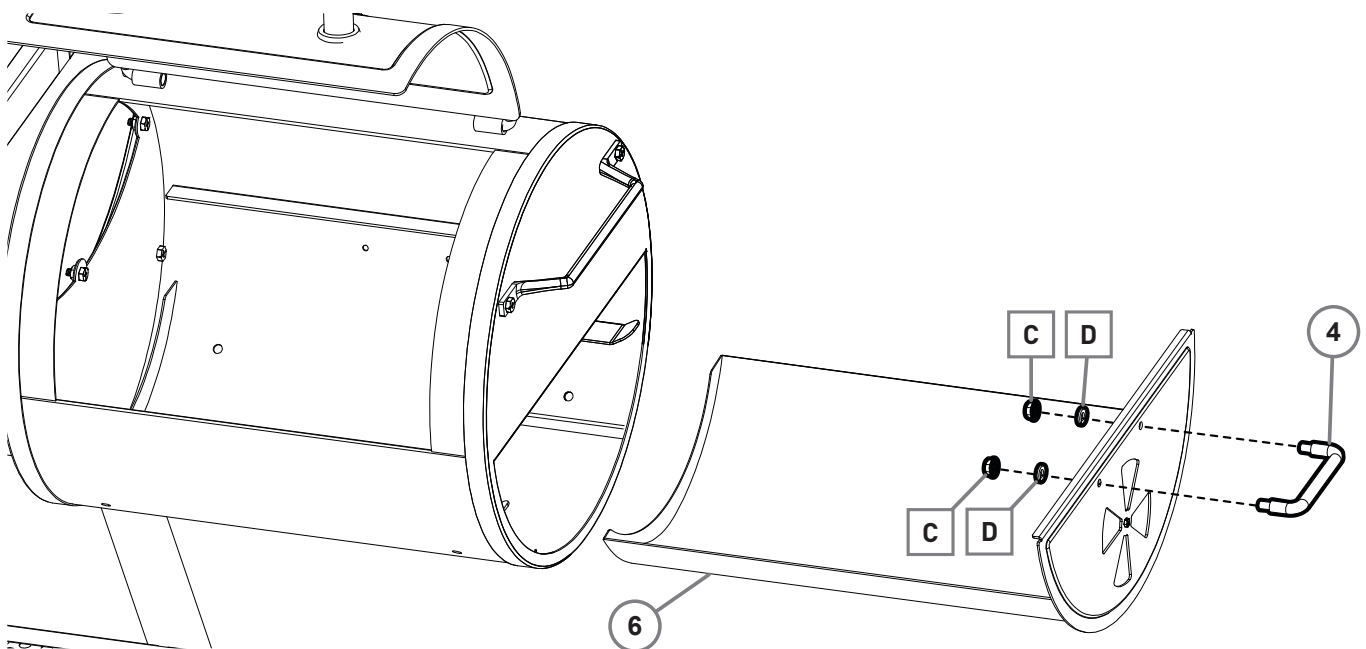



STEP 7

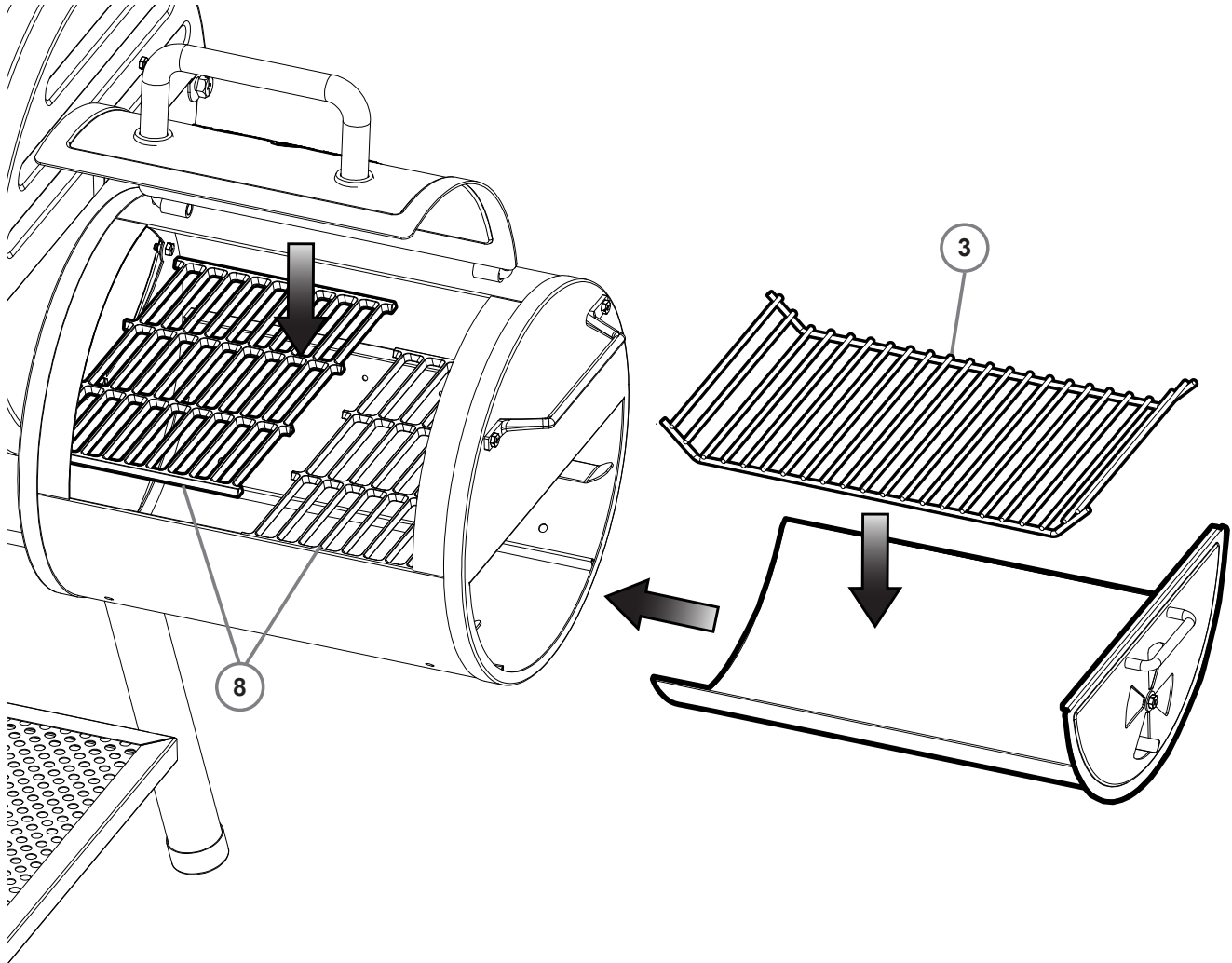

STEP 8

To ensure sturdy assembly, tighten all NUTS and BOLTS.

OPERATING INSTRUCTIONS

Setting Up

This grill is designed for use outdoors, away from any flammable materials. When in use, it is important that there are no overhead obstructions and that the grill is at least 3 ft. from any wall or surface. Maintain 10 ft. of clearance to objects that can catch fire or sources of ignition such as pilot lights on water heaters, live electrical appliances, etc. It is important that the ventilation openings of the grill are not obstructed.

The grill must be used on a level, stable surface. The grill should be protected from direct wind drafts and protected from any trickling water (i.e. rain or water from gutters). Do not move the grill while hot, and do not leave unattended during operation.

NEVER EXCEED **500°F** BECAUSE THIS WILL DAMAGE THE FINISH AND CONTRIBUTE TO RUST. PAINT IS NOT WARRANTED AND WILL REQUIRE TOUCH-UP. THIS UNIT IS NOT WARRANTED AGAINST RUST.



36 INCHES
(90 CM)





Lighting Instructions

There are a few methods to light your charcoal grill, depending on the materials you prefer to use. Using a charcoal chimney is the Char-Griller® preferred method for speed and convenience but igniting your lump charcoal or briquettes directly in the grill is a great way to get cooking as well.

Charcoal Chimney

1. Remove your grill grates and set them to side
2. Fill your charcoal chimney $\frac{3}{4}$ of the way full with briquettes or lump charcoal
3. Set fire starter on charcoal grate, light and then place the charcoal chimney directly on top of the fire starter
4. Coals will fire upward from bottom to top
5. After coals on top of chimney are ignited (usually 10-15 minutes) dump the coals over the charcoal grate and replace your grill grates



Fire Starters

1. Remove your grill grates and set them to side
2. Pour approximately 3lbs (approx. 50-60 briquettes) of charcoal directly on to your charcoal grate and stack together in a pile
3. Insert fire starter into the middle of the charcoal pile so that it is slightly covered and light
4. After the charcoal has thoroughly ignited, typically glowing red or gray in color, use tongs to spread them out and replace your grill grates



NOTE:

- Do not use lighter fluid, gasoline, kerosene, alcohol or other accelerant for lighting charcoal due to flammability, risk of bodily injury and potential to leave a distasteful flavor in your food.
- If necessary, use tongs to move coals for even heat.
- Always wear gloves when handling grill grates, charcoal grate, or adjusting coals.

Controlling Temperature

Controlling the temperature of your grill is all about controlling the air flow to the fire. MORE AIR = MORE HEAT. LESS AIR = LESS HEAT. By opening and closing the top and side dampers, you can easily control the temperature of your grill. The amount of charcoal used when grilling can also greatly impact your ability to control temperature. Dampers may need to be adjusted during the cook to account for changes in weather like wind or to accommodate for more or less fuel. When first learning how to operate your grill, always use the same amount of charcoal to best learn your grill's damper control.

SMOKE 150°-250°F

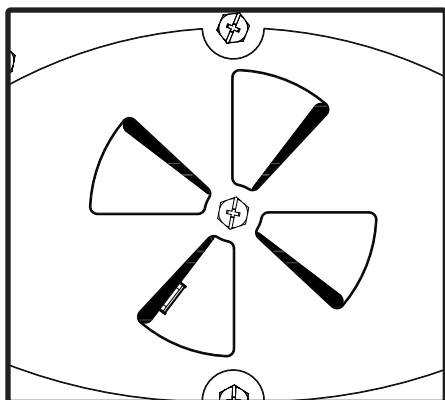
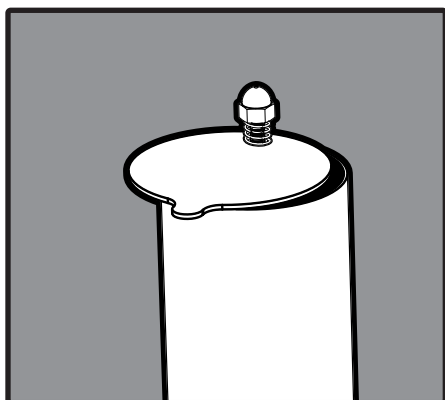

GRILL 300°-450°F

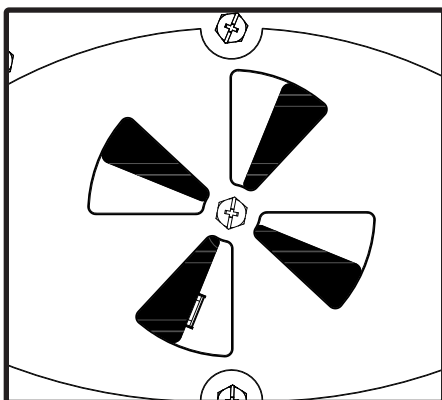
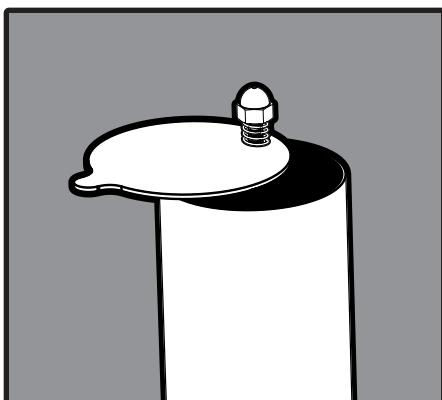

SEAR 450°-500°F

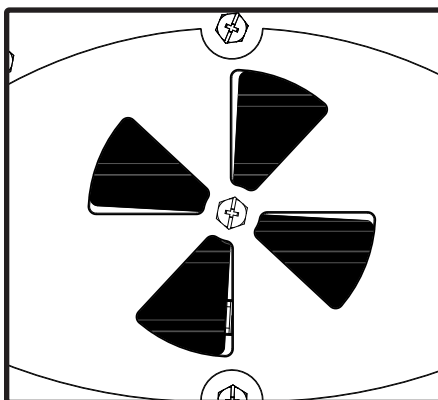
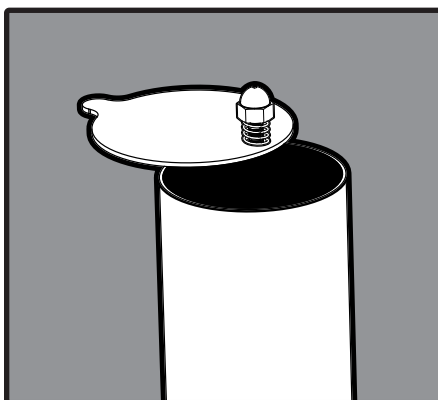

- Start with dampers 1/4 or less of the way open and adjust as needed during cook
- For best results, start with up to 2 lbs. of charcoal (30-40 Briquettes) and/or wood fuel
- Adjust the charcoal grate to its lowest setting or farthest from the cooking grates

- Control airflow as needed, by adjusting dampers from 1/3-2/3 of the way open
- For best results, start with up to 2 lbs. of charcoal (30-40 Briquettes)
- Place coals on one half of the charcoal grate - adjust charcoal grate level to the middle

- For maximum airflow, both dampers should be open all the way with air flowing freely
- For best results, start with up to 3 lbs. of charcoal (50-60 Briquettes)
- Adjust the charcoal grate to its highest setting or closest to the cooking grates



Seasoning Your Grill

Seasoning is an important first step before you start cooking on your new grill. This process will help protect the interior and exterior grill finish, reduce food sticking to the grates, reduce unnatural flavors, and help prevent the grates from rusting. Char-Griller® recommends using flaxseed oil for seasoning your grill but most food grade oils (canola, grapeseed, vegetable, safflower, etc) will work as well.



STEP 1 LIGHTLY COAT WITH OIL

1. Char-Griller® grills come pre-coated with vegetable oil. If this is the first time seasoning your grill, move on to **Step 2**
2. If re-seasoning your grill, lightly coat ALL interior surfaces (including grates and inside of barrel) of your grill with flaxseed or other vegetable oil



STEP 2 HEAT UP GRILL

1. Following the instructions for lighting your charcoal (page C-2) and controlling the temperature (page C-6), bring your grill to approximately 450°F
2. Once at temperature, allow grill surfaces to season for 20 minutes



STEP 3 RE-APPLY OIL TO GRATES 5X

1. After 20 minutes, open your grill and carefully remove your grill grates with a grate lifter
2. Using a brush, re-coat both sides of your grates with flaxseed or other vegetable oil and return to your grill
3. Close lid and allow surfaces to season for 20 minutes
4. Repeat this process up to five times (Add more charcoal to maintain temperature as needed)
5. Your grill is now ready for use

NOTE:

- You can lightly coat the exterior of the grill body (while warm) with vegetable oil. This will extend the life of the finish, much like waxing a car.

Grilling Styles

Your Char-Griller® grill can be used to smoke, grill or sear your food. By using temperature zones, charcoal and wood flavor, you can customize your culinary experience as desired. The following descriptions provide four of the most common ways you can cook with your Char-Griller® charcoal grill.

Grill

Cook with direct and indirect heat at medium temperatures (300°-450°F). Utilize a two zone set up to cook at different speeds and temperatures.

1. Set charcoal grate to medium setting (halfway between grill grates and grill body) using adjustable charcoal tray hangers
2. Prepare up to 2 lbs (approximately 30-40 briquettes) of lit charcoal spread evenly across HALF the charcoal grate creating 2 Cooking Zones.
3. Once the grill is at the desired temperature, you may begin to cook. First place food over direct heat, cooking each side as desired. After initially cooking over direct heat, move to the cool zone (see picture at right) to bring your food to the desired internal temperature.

GRILL (Direct Heat) - 300°-450°F
Up to 2 lbs. Charcoal (30-40 Briquettes)
Chacoal Grate adjusted to medium setting

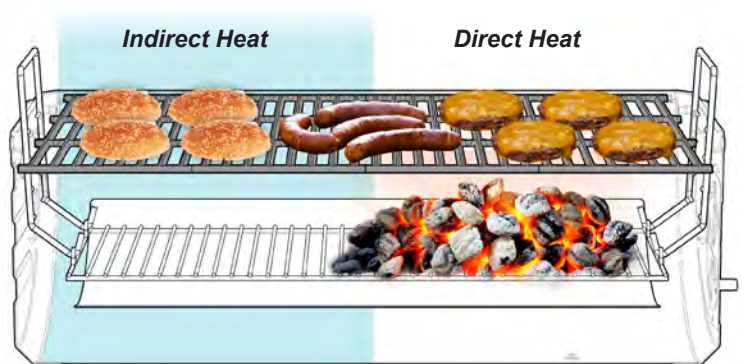

4. NOTE: Wood chips, chunks or split logs may be used in addition to charcoal to add smoke flavor as desired.

Sear

Quickly cook with direct heat at high temperatures (450°-500°F).

1. Set charcoal grate to high setting (closest to grill grates) using adjustable charcoal tray hangers
2. Prepare up to 3 lbs (approximately 50-60 briquettes) of lit charcoal spread evenly across charcoal grate.
3. Once the grill is at the desired temperature, you may begin to cook by placing food directly over the coals.
4. Food will cook quickly. Cook each side 3-4 minutes and then bring to desired internal temperature.
5. NOTE: Always sear with the grill lid open to prevent damage to exterior finish.

SEAR (HI-TEMP DIRECT HEAT) - 450°-500°F
Up to 3 lbs. Charcoal (50-60 Briquettes)
Chacoal Grate adjusted to highest setting or close to the cooking grates

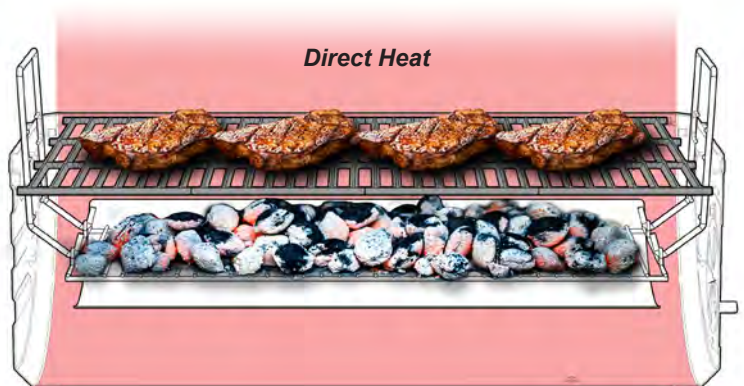

6. NOTE: Wood chips, chunks or split logs may be used in addition to charcoal to add smoke flavor as desired.



Smoke

Cook with indirect heat at low temperatures (150°-250° F). Use wood chips, chunks, split logs or pellets to add smoke flavor

1. Set charcoal grate to low setting (farthest from grill grates) using adjustable charcoal tray hangers
2. Prepare up to 2 lbs (approximately 30-40 briquettes) of charcoal spread evenly across HALF the charcoal grate creating two cooking zones
3. Add wood chips, chunks, or split logs as desired to add smoke flavor
4. Once the grill is to desired temperature, you may begin to cook
5. Keep food over cool side of grill to cook with indirect heat over the duration of the cook

SMOKE (INDIRECT HEAT) -

Up to 2 lbs. Charcoal (30-40 Briquettes)
Charcoal Grate adjusted to lowest setting or farthest from the cooking grates

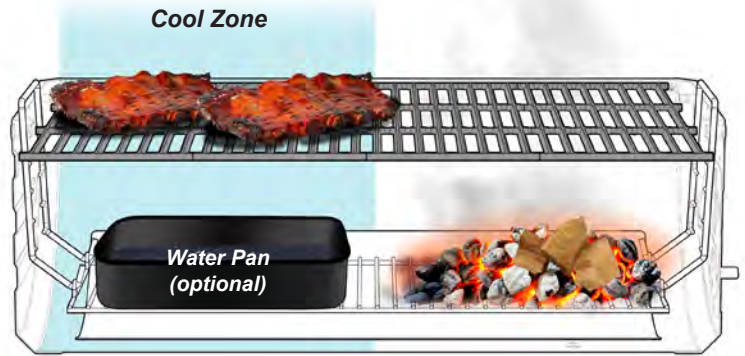

6. NOTE: Opening the smoking chamber will extend cooking time.

OFFSET SMOKE (INDIRECT HEAT) - 150-250° F

Up to 2 lbs. Charcoal (30-40 Briquettes)
and or wood fuel in the side fire box

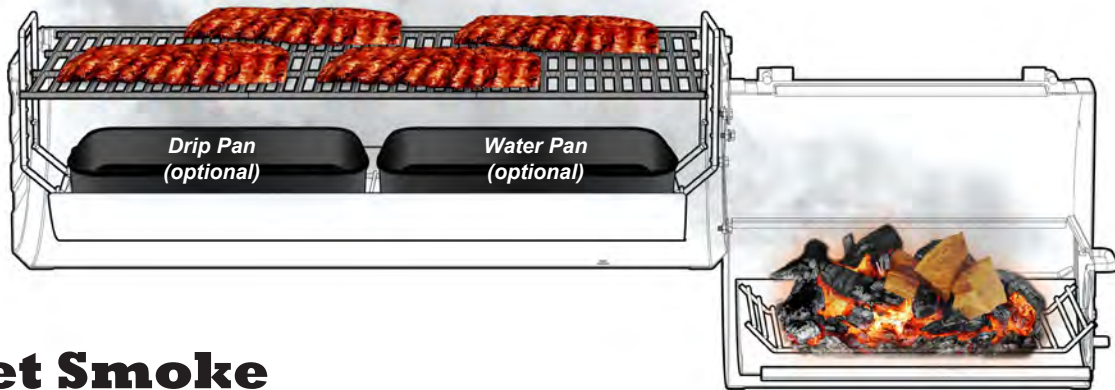

Offset Smoke

Cook with indirect heat from the side fire box at low temperatures (150°-250° F). Use split wood logs, chips, chunks, or pellets to add smoke flavor

1. Prepare up to 2 lbs (approximately 30-40 briquettes) of charcoal in the side fire box
2. Add wood chips, chunks, split logs or pellets as desired to add smoke flavor
3. Once the grill is at the desired temperature, begin to cook
4. Food placed closer to the side fire box will cook faster than food placed on the opposite side of the grill
5. NOTE: Opening the smoking chamber will extend cooking time.

Care & Maintenance

In order to keep your grill in the best shape, it's important to keep it clean and maintained. Continued cleaning and care are key to ensuring a long life for your Char-Griller® grill. Have questions? Call, email or chat online with Char-Griller® Customer Service!

FINISH UP



- When you are finished grilling, clean your grates with the Char-Griller® Grate Scrape and then lightly coat your grates with flaxseed or other vegetable oil
- Next close both dampers and the hood allowing the fire to suffocate
- Wait until coals and ash have completely cooled before attempting to clean up or remove

CLEAN UP

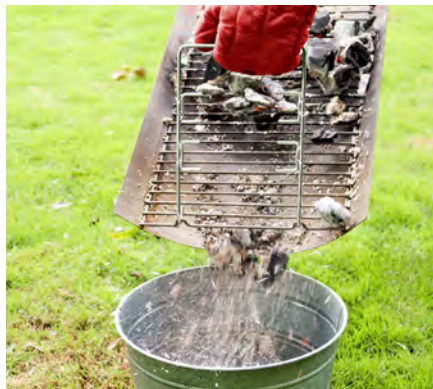

- Wait until the fire is completely extinguished and the grill is cool to the touch before emptying the ashes
- Remove grates from grill with grate lifter
- Remove ash pan from grill
- Give the ash pan a few firm taps to loosen any ash that may be stuck
- Dump the ashes in a metal container and cover with water to ensure there are no lit coals, then you can dispose of the ashes

COVER UP



- Extend the life of your grill by using a Char-Griller® custom fit grill cover to protect it from the elements
- Weather resistant polyester material protects against birds, dust, wind, rain and snow

**** ONLY EMPTY ASHES WHILE GRILL IS NOT IN USE AND COOL TO TOUCH ****

IMPORTANT: Charcoal is porous and holds moisture. DO NOT leave charcoal in your grill while you are not using it. Charcoal and ashes left inside the ash pan may reduce the life of your grill.



General Grilling Tips & Warnings

Control heat with amount and type of fuel, dual dampers, and adjustable fire grate. Adjust fire grate one end at a time. Wood burns hotter than charcoal. More airflow helps generate more heat.

Additional charcoal and/or smoking woods may be added while cook is in progress. Wear gloves and apron when operating your grill.

Only use natural hardwoods intend for cooking. Appropriate selections can typically be found in grocery stores and outdoor grilling retailers.

When utilizing a water pan, check the water level when cooking more than 4 hours or when you can't hear the water simmering. Add water by moving meat over and pouring water through cooking grates into water pan.

To reduce flare-ups, cook with hood in the down position.

When cooking with charcoal, leave the grill hood open during the initial start up and until coals ash over. The grill hood must remain open anytime the temperature gauge is greater than 500°F.

Always put charcoal on top of the charcoal grate and not directly into the bottom of the grill.

Do not use self-starting charcoal as it will give food an unnatural flavor.

Ashes left in grill too long between uses will absorb moisture and will cause rust. Be sure to empty ash after grill has cooled. Uncoated steel and cast-iron will rust when not properly cared for.

On the EXTERIOR PAINT, remove rust with wire brush and touch up with a high heat paint, available at most hardware/auto stores. Rustoleum® #241169 is the best color match.

Heat gauge may retain moisture, which will steam out during cooking. Gauge can be removed and calibrated in oven.

For a more tightly sealed grill, fill unwanted holes with nuts and bolts (not included).

Attach a metal can to the grease cup holder or on bottom shelf under the hole in the grill to catch drippings.

Smokestack and side dampers will be hot. Only touch using gloves or mitts.

Before you use your grill for the first time you must season the cast iron cooking grates.

After each use, coat the interior grates and bare metal with vegetable oil while warm to reduce the chance of rust. Proper and regular seasoning will protect against rust and extend the life of your grill and cooking grates.

Grill will drip oil during the seasoning process and for several uses afterwards, this is normal.

Never exceed 500°F because this will damage the finish and contribute to rust.

Paint is not warranted and will require touch up.











This grill is not warranted against rust.

DO NOT use lighter fluid, gasoline, kerosene, alcohol or other accelerant for lighting charcoal. Use of any of these or similar products could cause an explosion possibly leading to severe bodily injury.

NOTE: Smoke may escape from areas other than the smokestack. This will not affect cooking

CHAR-GRILLER® DOES NOT ACCEPT RETURNS ON USED GRILLS.

Cooking Guidelines

 BEEF	HEAT TYPE	HEAT LEVEL	AVG. COOKING TIME
SKIRT STEAK, MEDIUM 1-INCH THICK			4-6 MIN.
HOT DOG 4 OUNCES			5-7 MIN.
STEAK, MEDIUM 1-INCH THICK - FILET MIGNON, RIBEYE, NEW YORK STRIP & PORTERHOUSE			6-8 MIN.
BURGER 3/4 - INCH THICK			8-10 MIN.
HANGER STEAK, MEDIUM 1-INCH THICK			8-10 MIN.

HEAT KEY

 DIRECT HEAT









 INDIRECT HEAT

 SMOKE

 LOW HEAT
150°-250°F

 MEDIUM HEAT
300°-450°F

 HIGH HEAT
450°-550°F+

 PORK	HEAT TYPE	HEAT LEVEL	AVG. COOKING TIME
PORK CHOP, MEDIUM 1-INCH THICK			8-10 MIN.
SAUSAGE 3-OUNCE LINK			10-13 MIN.
PORK TENDERLOIN 1 POUND			15-20 MIN.
PORK SHOULDER/BUTT 8 POUNDS			12 HOURS <small>APPROX. 90 MIN / LB.</small>









USDA SAFE MINIMAL INTERNAL TEMPS

FISH & SHELLFISH:
145°F









**BEEF OR PORK STEAKS
OR CHOPS:** **145°F**

GROUND BEEF OR PORK:
160°F

CHICKEN:
165°F

 CHICKEN	HEAT TYPE	HEAT LEVEL	AVG. COOKING TIME
CHICKEN BREAST OR THIGH 4 OUNCES - BONELESS, SKINLESS			8-12 MIN.
CHICKEN THIGH OR LEG 3-6 OUNCES - BONE-IN*			35-45 MIN.
CHICKEN BREAST 10-12 OUNCES - BONE-IN*			35-45 MIN.
WHOLE CHICKEN* 8 POUNDS			3-5 HOURS

*BONE-IN CHICKEN SHOULD INITIALLY BE COOKED OR "BROWNE" OVER DIRECT HEAT FOR SEVERAL MINUTES BEFORE BEING TRANSFERRED TO INDIRECT HEAT.

 SEAFOOD	HEAT TYPE	HEAT LEVEL	AVG. COOKING TIME
SHRIMP LARGE			4-6 MIN.
SCALLOP 1 1/2 OUNCES			4-6 MIN.
FISH, FILET 1-INCH THICK			5-10 MIN.
FISH, WHOLE 1 POUND			15-20 MIN.

Cook times outlined in this chart are general guidelines that may vary depending on desired doneness, thickness, amount of each item being cooked, grill or grilling style, ambient temperature and/or weather. Char-Griller® recommends always using a cooking thermometer to gauge the internal temperature of all meat products.







FIND MORE RECIPES AT
CHARGRILLER.COM



ENHANCE FLAVOR

Wood Pairing Guide

Different wood varieties possess different flavors and Char-Griller® recommends pairing your woods with the meats you intend to cook.

WOOD	FLAVOR	 BEEF	 PORK	 POULTRY	 SEAFOOD	 VEGGIES
ALDER	MILD			✓	✓	
MAPLE	MILD			✓		✓
CHERRY	MILD		✓	✓	✓	
APPLE	MEDIUM	✓	✓	✓	✓	
PECAN	MEDIUM	✓	✓	✓	✓	✓
OAK	MEDIUM	✓	✓	✓	✓	✓
HICKORY	STRONG	✓	✓			
MESQUITE	STRONG	✓	✓			



FAVORITE ACCESSORIES

FOR THE FULL LINE OF ACCESSORIES VISIT CHARGRILLER.COM



Custom Fit Cover

Weather Resistant
Protects Grill Finish

Model #2455



Quick Release Chimney Starter

E-Z starter with patented
Trigger release
ABS handle with heat shield
Zinc coated galvanized steel
Makes starting charcoal grill
fast and easy

Model #19586



Apron

Machine Washable
Two Front Pockets
Adjustable Straps

Model #9955



Folding Probe Thermometer

Stainless steel
fast-read probe accurately
measures temperature
Easily switch from °F to °C
Auto ON/OFF feature for
extended battery life

Model #6304



Char-Griller® Trucker Hat

Cotton-poly blended front
Nylon mesh back
Adjustable snapback closure
One Size Fits Most

Model #70100



Original All-Purpose BBQ Rub

Pairs well with all types
of meat and fish

Model #85501



P.O. Box 30864
Sea Island, GA 31561
912-638-4724
www.CharGriller.com
Service@CharGriller.com

