

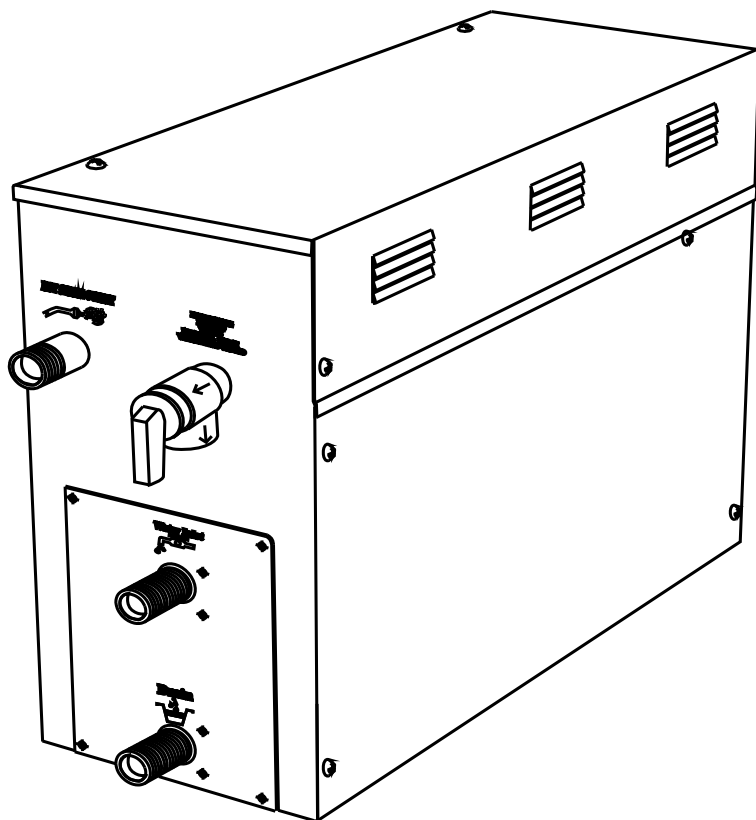

## STEAM BATH GENERATOR USER GUIDE



### MODELS

**4.5KW**

**6KW**

**7.5KW**

**9KW**

**10.5KW**

**12KW**

**15KW**



## READ ME FIRST!

**IMPORTANT NOTE:** As you follow these instructions, you will notice warning and caution symbols. This blocked information is important for the safe and efficient installation, operation and maintenance of this generator. These are types of potential hazards that may occur during this installation and operation:



 **WARNING** states a hazard may cause serious injury or death if precautions are not followed.

 **CAUTION** signals a situation where minor injury or product damage may occur if you do not follow instructions.

**IMPORTANT NOTE:** This highlights information that is especially relevant to a problem-free installation.

# IMPORTANT SAFETY INSTRUCTIONS

When installing and using this electrical equipment, basic safety precautions should always be followed, including the following:

1. **READ AND FOLLOW ALL INSTRUCTIONS**
2.  **WARNING** To reduce the risk of injury, children under the age of 16 should not use the steam bath.
3.  **WARNING** To reduce the risk of injury:
  - A. The wet surfaces of steam enclosures may be slippery. Use care when entering or leaving.
  - B. The steam head is hot. Do not touch the steam head and avoid the steam near the steam head.
  - C. Prolonged use of the steam system can raise excessively the internal human body temperature and impair the body's ability to regulate its internal temperature (hyperthermia). Limit your use of steam to 10-15 minutes until you are certain of your body's reaction.
4. **SAVE THESE INSTRUCTIONS**
- D. Excessive temperatures have a high potential for causing fetal damage during the early months of pregnancy. Pregnancy or possibly pregnant women should consult a physician regarding correct exposure.
- E. Obese persons and persons with a history of heart disease, low or high blood pressure, circulatory system problems, or diabetes should consult a physician before using a steambath.
- F. Persons using medication should consult a physician before using a steambath since some medication may induce drowsiness while other medications may affect heart rate, blood pressure and circulation.

## HYPERTHERMIA

The causes, symptoms, and effects of hyperthermia may be described as follows: Hyperthermia occurs when the internal temperature of the body reaches a level several degrees above the normal body temperature of 98.6° F. The symptoms of hyperthermia include an increase in the internal temperature of the body, dizziness, lethargy, drowsiness, and fainting.

The effects of hyperthermia include:

- a) Failure to perceive heat
- b) Failure to recognize the need to exit the steambath
- c) Unawareness of impending risk
- d) Fetal damage in pregnant women
- e) Physical inability to exit the steambath
- f) Unconsciousness.

 **WARNING** The use of alcohol, drugs, or medication can greatly increase the risk of hyperthermia.

 This peel-n-stick warning label must be applied to the wall of the shower or steam enclosure, at a point visible to all users. Failure to install sticker may result in serious injury or death. For replacement label contact SteamSpa at 1-800-856-0172 or [info@steamspa.com](mailto:info@steamspa.com).

## WARNING

### REDUCE THE RISK OF OVERHEATING AND SCALDING

1. EXIT IMMEDIATELY IF UNCOMFORTABLE, DIZZY OR SLEEPY. STAYING TOO LONG IN A HEATED AREA IS CAPABLE OF CAUSING OVERHEATING.
2. CHILDREN UNDER THE AGE OF 16 SHOULD NOT USE THE STEAM BATH.
3. CHECK WITH A DOCTOR BEFORE USE IF PREGNANT, DIABETIC, IN POOR HEALTH OR UNDER MEDICAL CARE.
4. BREATHING HEATED AIR IN CONJUNCTION WITH CONSUMPTION OF ALCOHOL, DRUGS, OR MEDICATION IS CAPABLE OF CAUSING UNCONSCIOUSNESS.
5. DO NOT CONTACT STEAM HEAD OR STEAM AT THE STEAM HEAD.

### REDUCE THE RISK OF SLIPPING AND FALL INJURY

1. USE CARE WHEN ENTERING OR EXITING THE STEAM ROOM. FLOOR MAY BE SLIPPERY.

NOTE: FOR ADDITIONAL SAFETY CONSIDERATIONS SEE OWNER'S MANUAL

# TABLE OF CONTENTS

**PROLOGUE..... 4**

**USER INSTRUCTIONS ..... 4**

**CHOOSING THE RIGHT LOCATION ..... 4**

**INSTALLATION DRAWING OF STEAM GENERATOR ..... 5**

**PLUMBING INSTALLATION ..... 8**

**STEAM GENERATOR SPECIFICATIONS ..... 10**

**ELECTRICAL REQUIREMENTS ..... 11**

**ASSEMBLY GRAPH FOR POWER WIRE ..... 12**

**INSTALLATION OF THE TOP LIGHT ..... 14**

**STEAM GENERATOR DISSECTION DIAGRAM ..... 15**

**CARE & USE FOR THE CONTROL PANEL ..... 16**

**CONTROLLER BOX CONTENT ..... 16**

**CONTROL PANEL INSTALLATION INSTRUCTIONS ..... 17**

**TESTING THE MACHINE ..... 18**

**CONTROL PANEL DIAGRAM ..... 18**

**CONTROL PANEL OPERATION ..... 19**

**STEAM GENERATOR MAINTENANCE ..... 25**

**TECHNICAL PARAMETERS..... 29**

**WIRING DIAGRAMS ..... 30**

# PROLOGUE

Thank You for choosing SteamSpa for health, beauty and relaxation. Now you can enjoy your own private sanctuary in the comfort of your own home. Let your stress melt away as you relax in your state of the art Steam Room.

For Centuries people have recognized the health benefits of saunas. Leave your stress behind and enter a world of total relaxation, ridding you of pain, toxins, and sore muscles as well as increasing your blood circulation etc., leaving your skin glowing. Besides these physical effects, a SteamSpa Session will leave you totally relaxed by providing you a peaceful and relaxing environment away from all.

Our advanced technology, engineering, and product development provides Steam Generators that enhance the lifestyles of people throughout the world. SteamSpa is continuously refining, updating and developing their products assuring the optimum quality and performance of their products. Working with the industries top engineers we have developed the most efficient, dependable and highest quality products.

# USER INSTRUCTIONS

1. Check for visible damages upon delivery of Generator. Any damages to packaging should be reported immediately to shipping company delivery representative and SteamSpa's Customer Service Dept.
2. Check model and accessories are correct, including voltage input. Any discrepancies are to be reported to SteamSpa's Customer Service Dept. within 48 hours of delivery.
3. Read installation instructions in detail for a secure and effective installation of SteamSpa generators.
4. SteamSpa recommends the use of a licensed plumber and electrician for proper installation of SteamSpa generators.
5. SteamSpa shall not be responsible for product damage or malfunction caused by self-installation or installation procedures which do not comply with the user manual.
6. SteamSpa generators are for indoor use only.

# CHOOSING THE RIGHT LOCATION

1. The generator should be less than 25ft from the steam room for best performance.
2. The steam generator should not be installed in the steam room
3. Do not install outdoor or in any places that will influence the performance of the machine by the environment.
4. Do not install in a frigid location or any places where the water will freeze.
5. Do not install near flammable chemicals.
6. Install in a dry place where the ventilation is good.
7. Install an exhaust fan outside of the steam room for the excess steam to be expelled from the shower room.
8. The steam generator has a hanging groove for wall installations..
9. Both sides and the top of the steam generator need to reserve at least 12 inches space.
10. The area where the machine is installed must be easily cleaned up and convenient for the disassembly of the machine.
11. The installation area must be convenient for the steam generator draining system.
12. The steam tube, safety valve, drain valve, water tube and steam outlet remain very heated after the steam generator has stopped working for some time.
13. The controller panel should be installed away from the steam head to avoid false readings, please read the instructions for the controller's installation and operation.

# INSTALLATION DRAWING OF STEAM GENERATOR

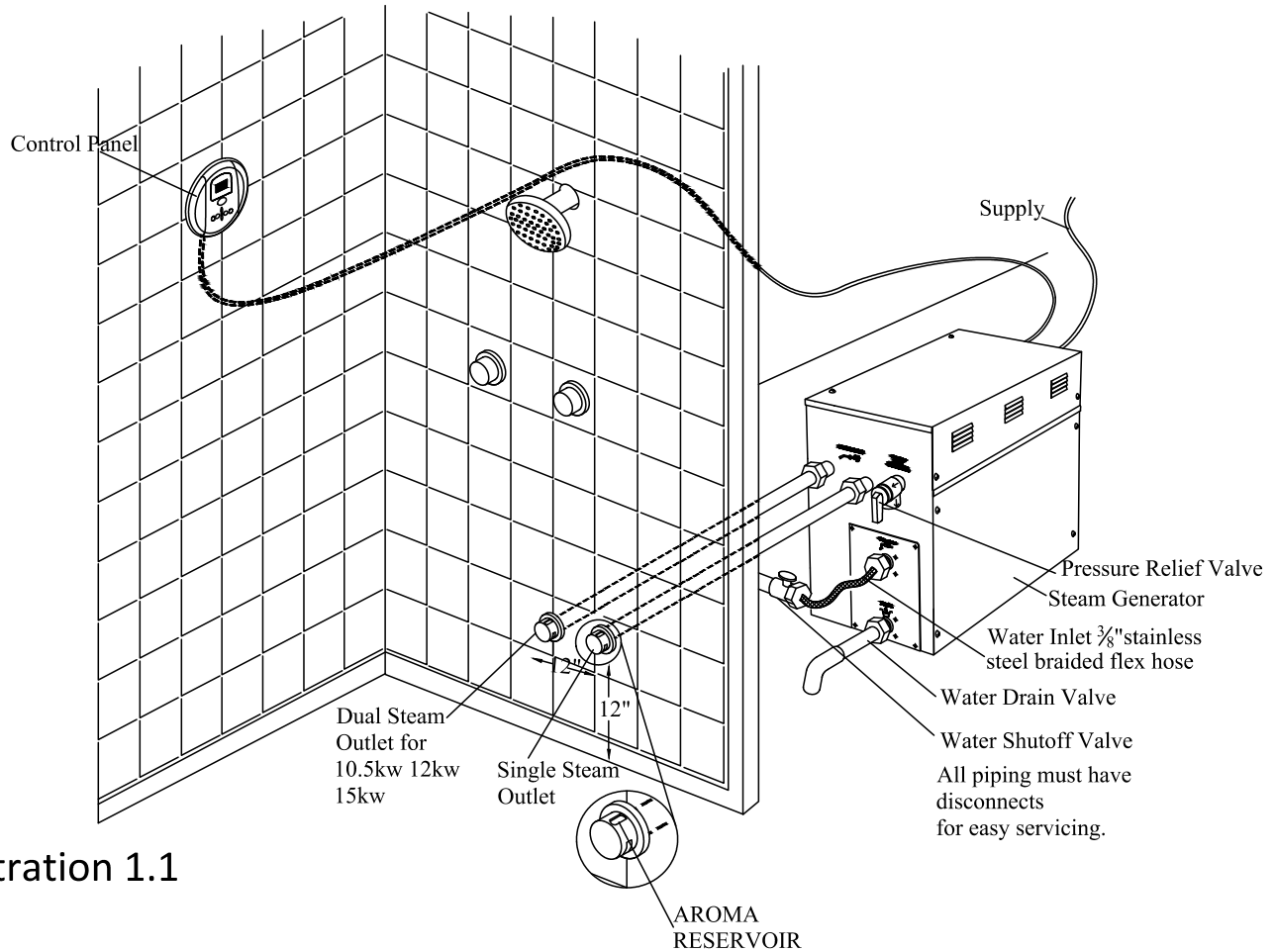

Illustration 1.1

**ATTENTION!** The drawing is only for explanation purposes. As for practical design of steam room, please consult with a qualified designer, architect or builder.

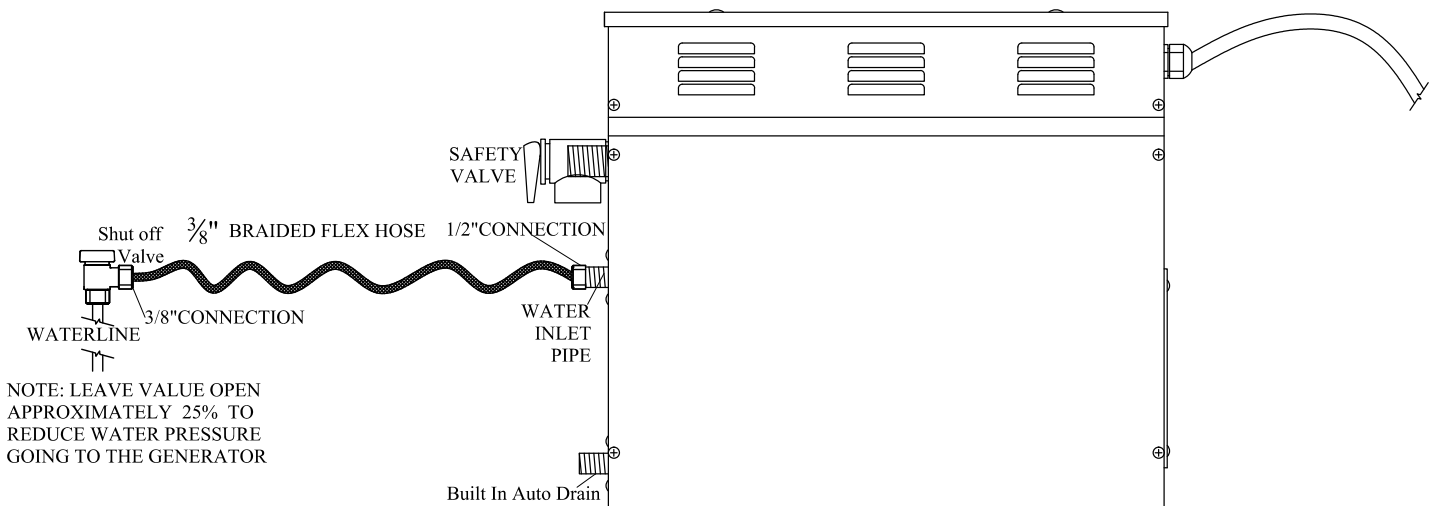

Illustration 1.2

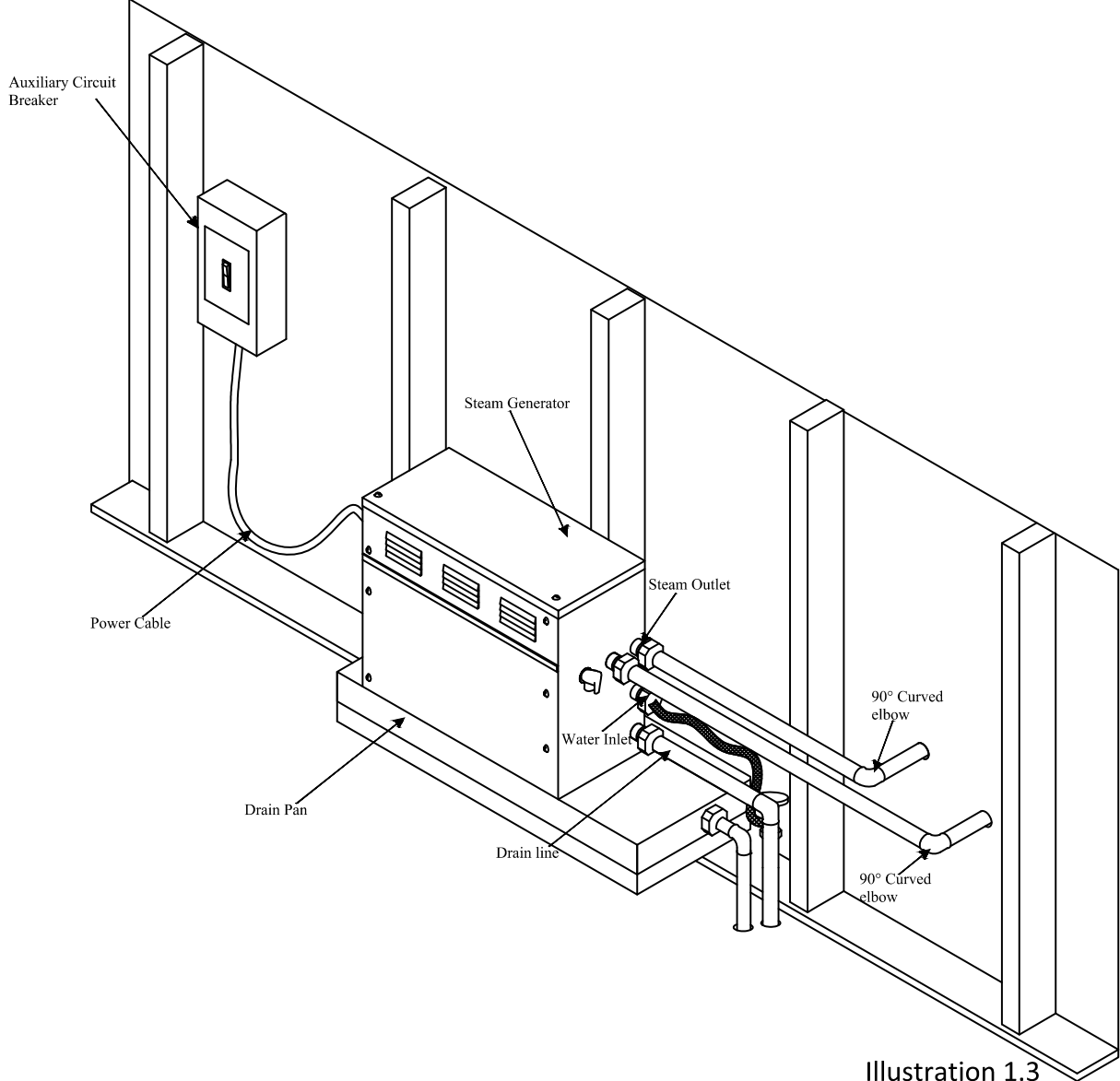
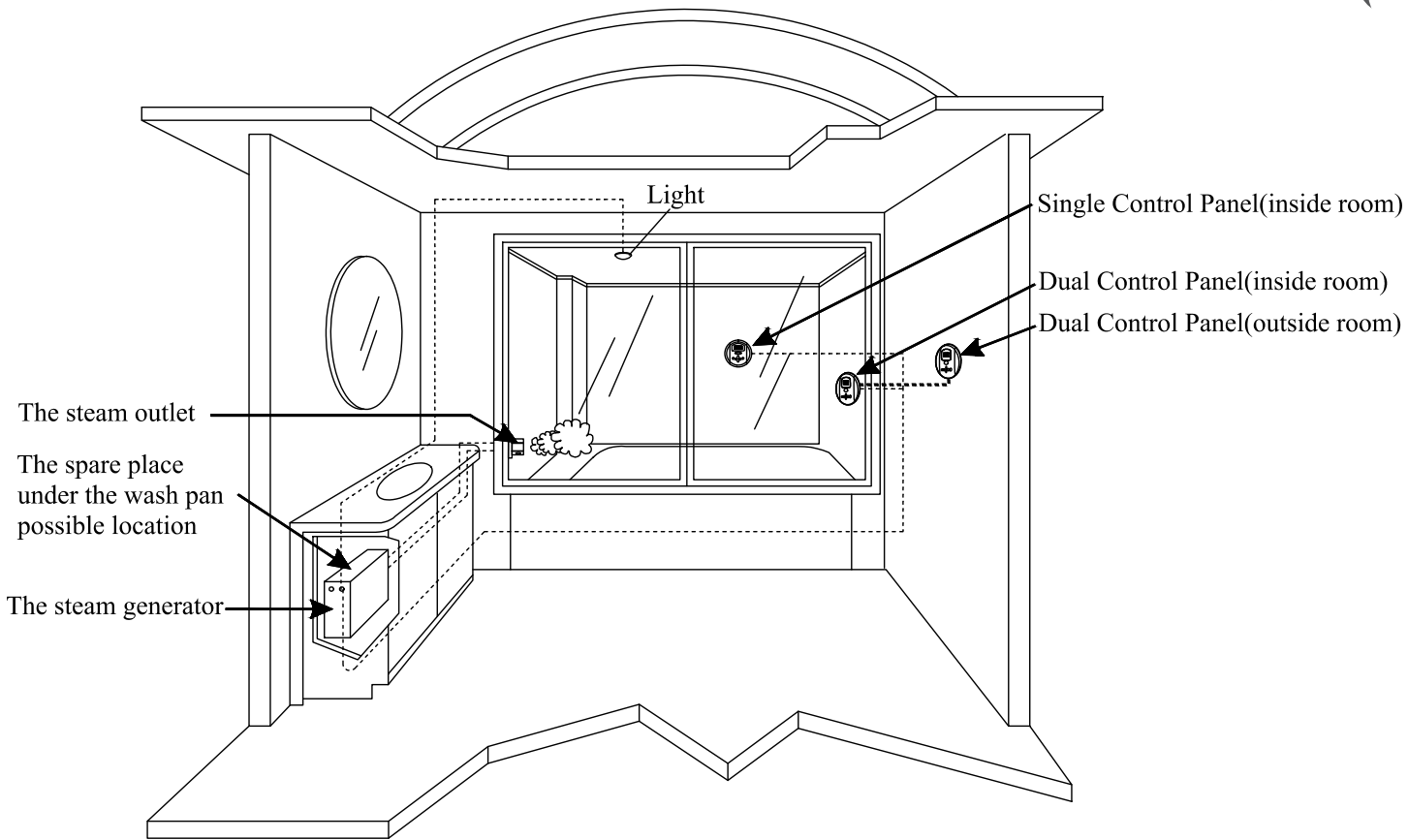

Illustration 1.3

**ATTENTION!** The drawing is only for explanation purposes , please consult with a qualified designer, architect or builder.



**ATTENTION!** The illustration is just an example; the practical installation must comply with the nation's electrical criteria, and be done by a professional electrician.

The steam generator maybe installed in these location.

1. In closet located behind the shower.
2. In Attic
3. In basement etc.

**ATTENTION!** If the installation of the steam generator will be more then 10 to 15 feet away from the steam room. It is recommended to increase the size of the generator 1 or 2 kilowatts higher to increase the steam flow.

# PLUMBING INSTALLATION

**WARNING!** The installation of all water supply lines should be in accordance to all national and local codes by a licensed plumber.

1. Use adapters and unions when connecting pipes to generator.
2. Use brass pipes or copper pipe only.
3. Do not use black and galvanized or PVC pipes.

## WATER SUPPLY PIPE (1/2")

1. Connect hot water or cold water pipes. However it should not exceed 160F.
2. Install a shut off valve in the water supply line. The shut off valve should be installed in a place where it is easily accessible in case of an emergency.
3. Flush the water supply line completely before connecting the water pipe to the steam generator, to remove any sediments in the water.
4. Use a 3/8" steel braded flex hose with a shut off valve to connect the main waterline to the generator. See page 5 illustration 1.2.
5. The shut off valve should be open approximately 25% to reduce water pressure to the generator. The water pressure to the generator should be between 10 to 15 PSIG if necessary, decrease the pressure accordingly.
6. It is highly recommended to install a pressure reducing valve (10 to 15 PSI).
7. Do not use PEX or PVC tubing.

## STEAM PIPE (3/4")

1. Do not install any stop valves in the steam pipes. The steam can never be obstructed.
2. Install a 3/4" copper or brass pipe between the steam generator and the steam nozzle.
3. If needed, the heat insulation material used to insulate the steam pipe should be resistant to temperatures as high as 240F or higher.
4. The shorter the distance, the better. Use 90 degree elbows when pipes turn to allow the steam to flow smoothly through the steam pipe.

**ATTENTION!** Ensure there are no dips or valleys along the steam outlet line to avoid trapping the steam.

**ATTENTION!** DO NOT install the drain valve into steam line.

**ATTENTION!** DO NOT connect the safety relief vave into the steam line.

## STEAM HEAD (3/4")

**ATTENTION!** Steam Head and the steam outlet gets very hot, try to avoid installing the steam head in a position which will easily come into contact with the person bathing.

1. Install the steam head approximately 12 inches above the ground floor. If the steam room material is acrylic or non-heat-resistant sheet, please consult with material manufacturer about steam room applications.
2. The steam head outlet should be installed face down. To prevent scalding bather with steam or water.

**ATTENTION!** Tighten steam head by hand. Do not use a spanner or other tools, use a little soap water and soft sponge to wipe, and do not use erosive chemical solutions or crude cleaning tools.

## IMPORTANT!

1. Please consult manufacturer of materials like acrylic, fiber glass or other anti-heat sheet about the installation of the steam head.
2. In the entire steam room, it is required that steam does not leak out. The pipes, its accessories and the holes should be air tight by applying sealant so that no steam will enter the holes in the wall.



## **DRAINPIPE (1/2")**

**ACCORDING TO THE NATIONAL AND LOCAL PLUMBING CODES:** The steam generator drain valve should be equipped with a drainpipe. The steam generator drains the water by gravity. Check local code requirements for drain valves. Do not connect the safety valve or steam line to drain line.

## **SAFETY VALVE (3/4")**

1. Safety valve is an automatic system that is actuated by pressure in order to prevent steam pressure increasing in the interior of the generator .
2. The pressure limit range of the safety valve is 15 PSIG and the pressure will begin to decrease if pressure should come over this value.
3. If it is allowed by local codes, provide the safety valve with exterior drainpipe.
4. Do not dismantle the pressure relief valve while generator is in operation..
5. To maintain the proper automatic operation of the safety valve, make sure the safety valve connection pipe is smooth.

# STEAM GENERATOR SPECIFICATIONS

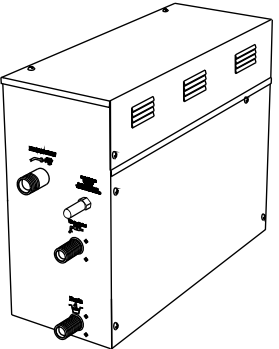
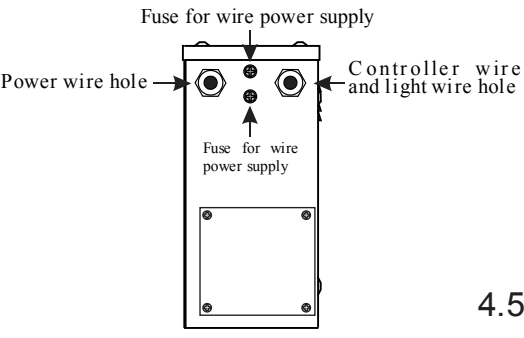
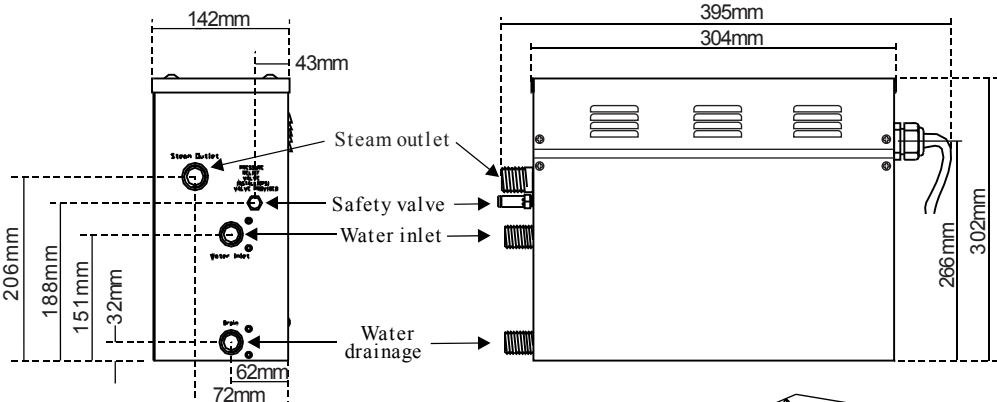

4.5kW

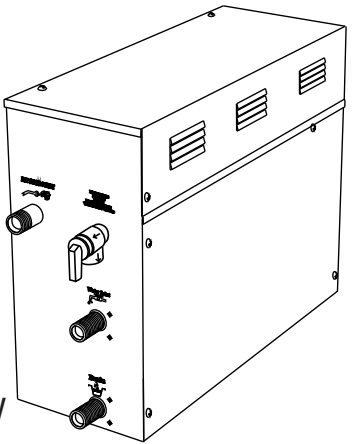
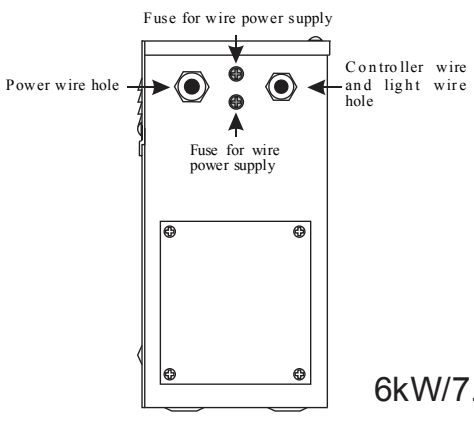
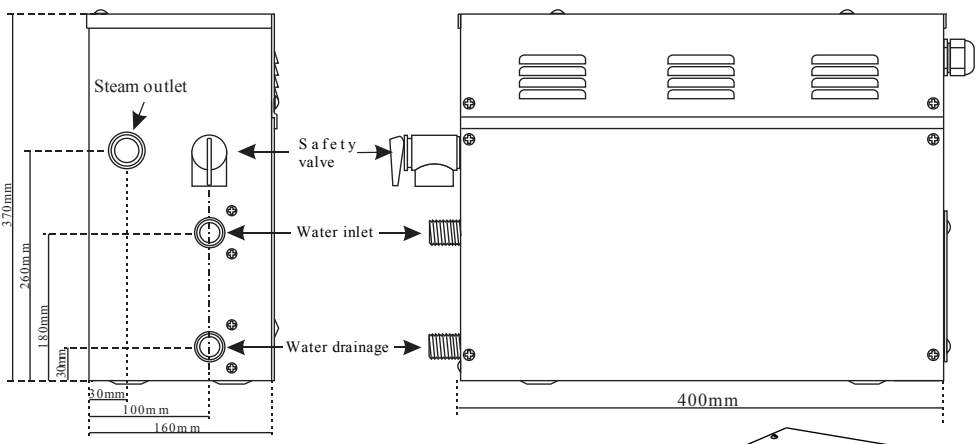

6kW/7.5kW/9kW

INSTALLATION & USER GUIDE

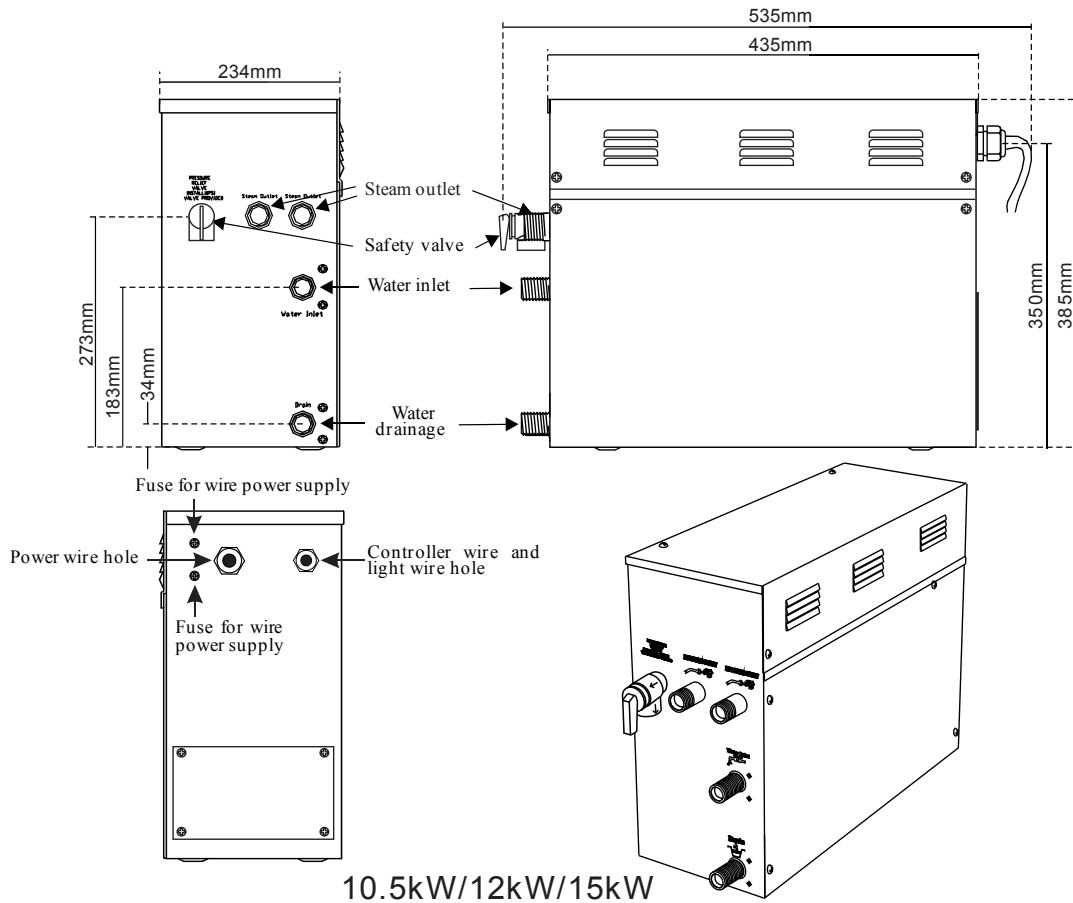

**ATTENTION!** To facilitate maintenance, keep the steam engine clean. If the information provided is limited, do not operate on the pipeline and electric equipment arbitrarily as shown in the figure for proportion.

## ELECTRICAL REQUIREMENTS

### ELECTRICAL SUPPLY CIRCUITRY

1. Test the voltage of the power supply and make sure suitable voltage is used for the steam generator.
2. Insulated copper wire should be used with an anti-heat temperature of 90 C and a specified voltage of 300V. Refer to national or local electricity consumption code for the specifications. Refer to the ammeter for the ampere.
3. Connect suitably sized equipment grounding wire into the ground terminal.
4. All the connections must be in accordance with national and local electricity consumption codes and be installed by professional electricians.

### Ampere Meter

Type	Applicable space of the room (cu.Ft. *)	Power KW	Electricity supply (1PH)	Electric current (A)	Specifications for power wire (AWG)
S450	90	4.5	240V	19	12
S600	150	6	240V	25	10
S750	225	7.5	240V	32	8
S900	300	9	240V	38	8
S1050	400	10.5	240V	44	6
S1200	450	12	240V	50	6
S1500	500	15	240V	63	6

The data provided above is for 240V single-phased motors. Install an independent circuit breaker between supply line and steam generator. Install a power disconnect within sight of steam generator to cut-off power when not in use.

## ASSEMBLY GRAPH FOR POWER WIRE

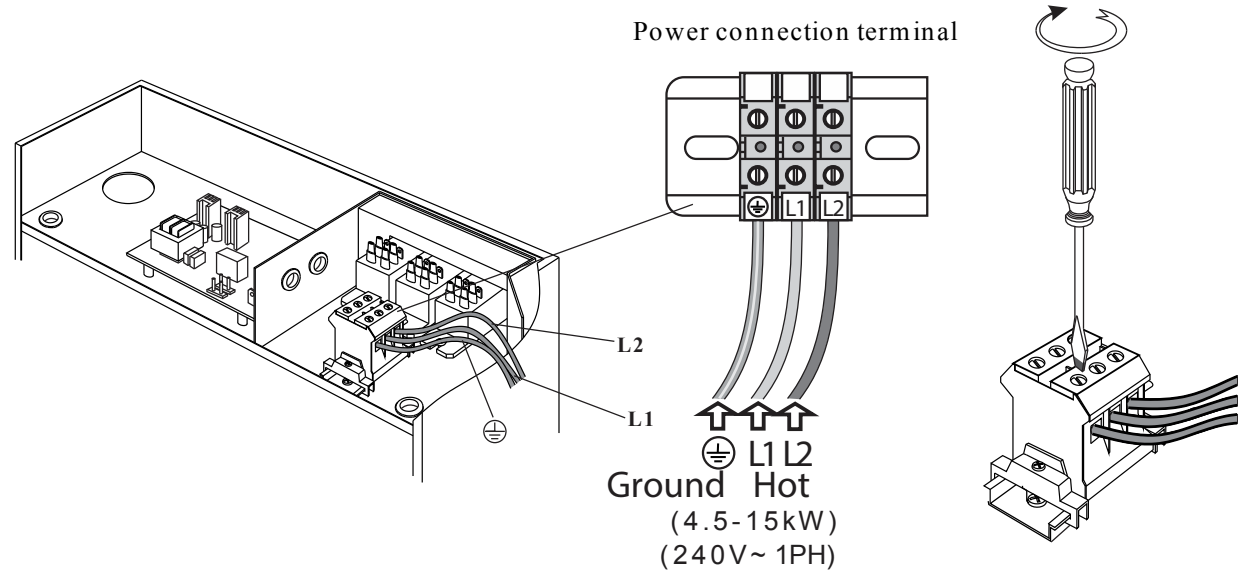

**ATTENTION!** To avoid damage to the equipment, do not connect electric current directly to heating elements.  
**WARNING!** This graph is for explanation only. For actual installation, refer to national and local electricity consumption codes by professional electricians.

# WIRING DIAGRAM

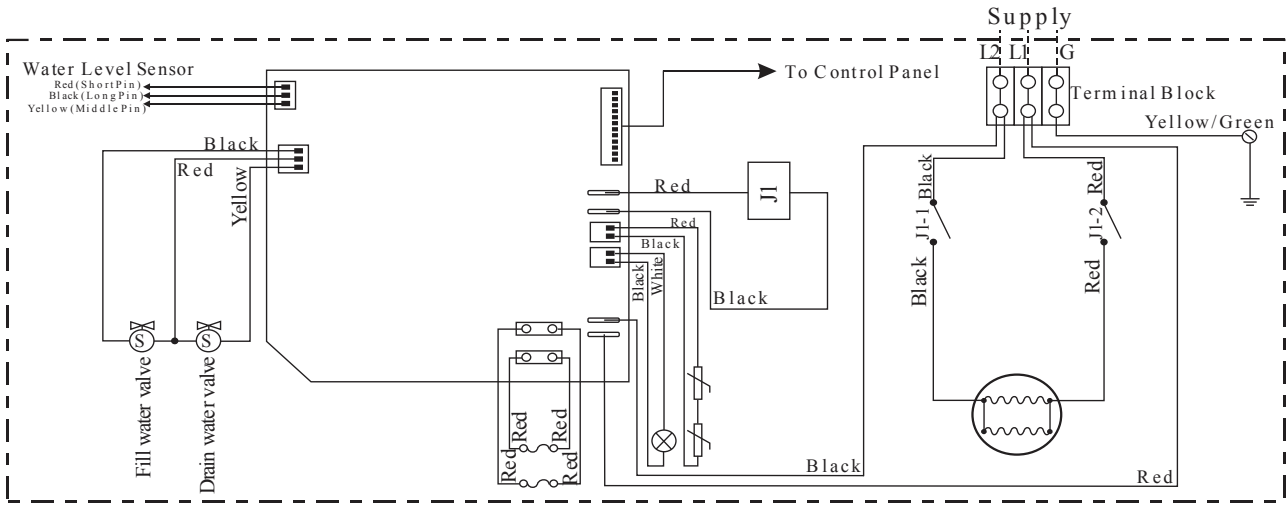

S450

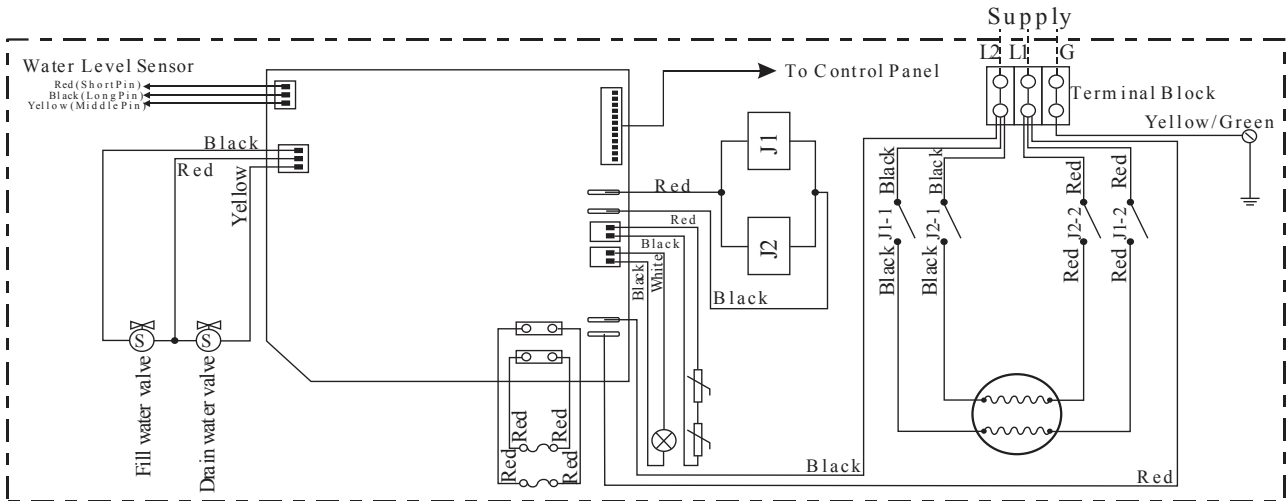

S600

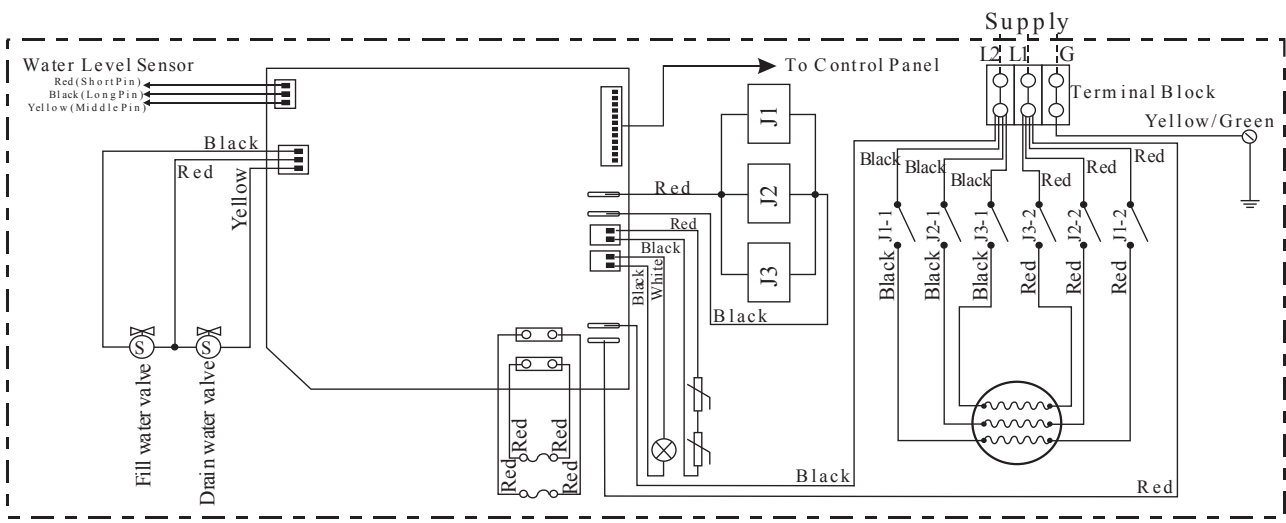

S750 S900

INSTALLATION & USER GUIDE

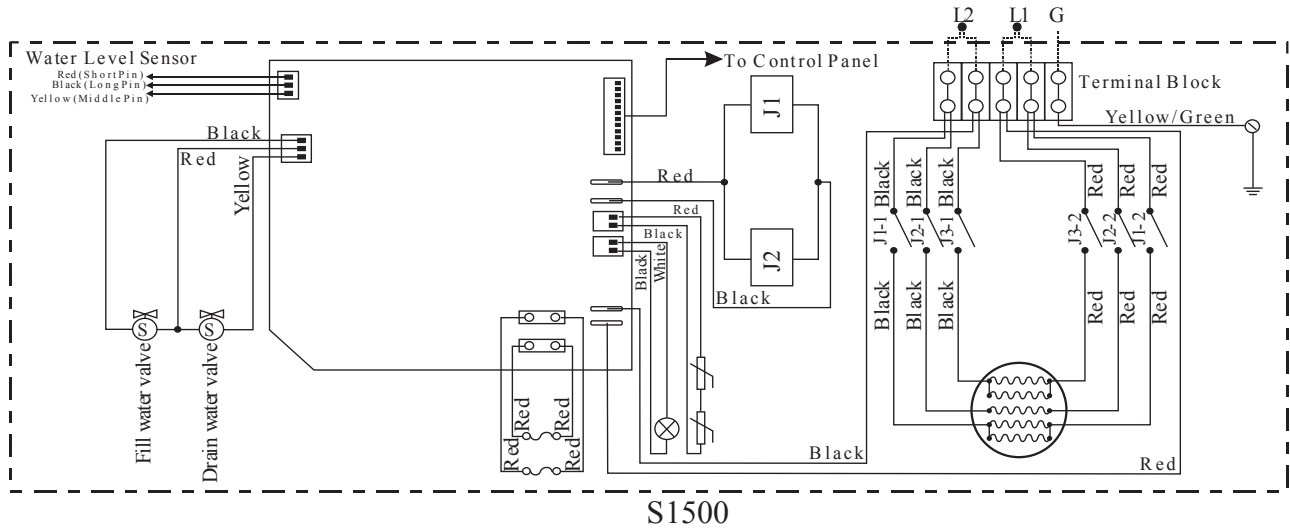
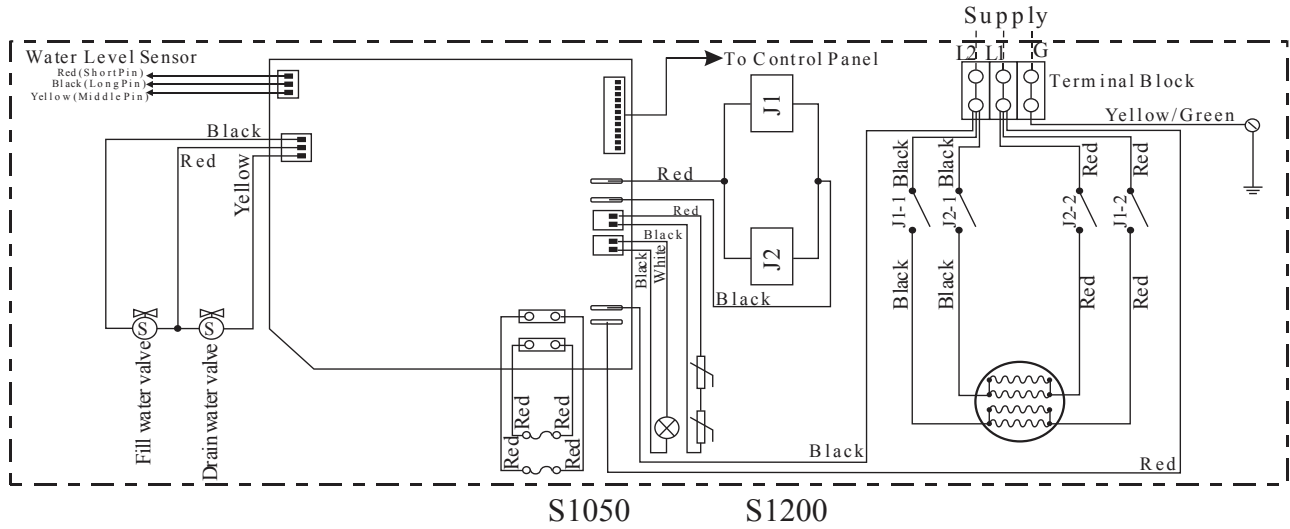

## INSTALLATION OF THE TOP LIGHT

**CAUTION!** The power of the light should not surpass 3 watts (rated power) to prevent the damage of the transformer.

1. A whole set is equipped with AC 12V 3 watt LED lamp.
2. The light should be installed on the ceiling of the steam room or in a location not accessible to children.

**CAUTION!** Installer must take some moisture proof measures in the process of installation. Electrophorus components cannot be exposed to moisture, as it will cause damage to the light components causing a possible short circuit.

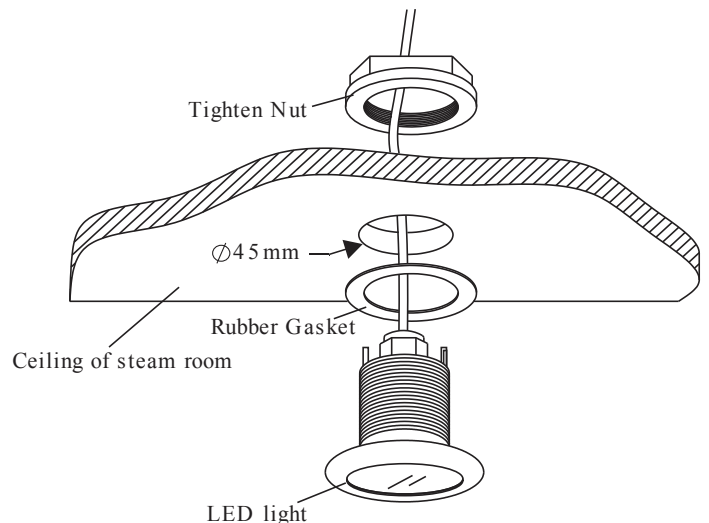

# STEAM GENERATOR DISSECTION DIAGRAM

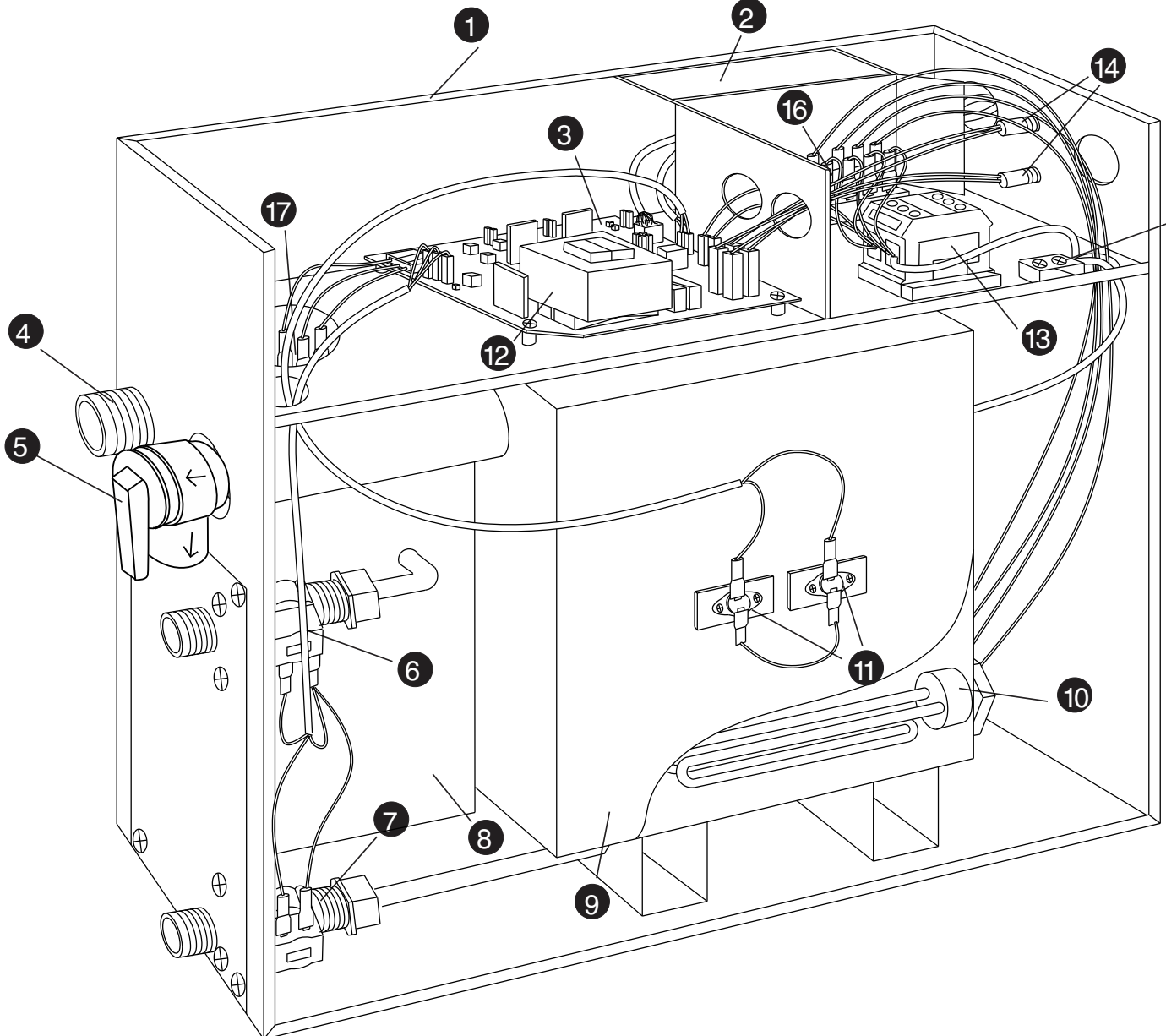

- |                          |                          |                           |
|--------------------------|--------------------------|---------------------------|
| 1. ENCLOSURE             | 7. WATER DRAIN VALVE     | 13. TERMINAL BLOCK        |
| 2. INSULATION BRACKET    | 8. SUBSIDIARY WATER TANK | 14. FUSE                  |
| 3. CIRCUIT BOARD         | 9. MAIN WATER TANK       | 15. GROUND WIRE CONNECTOR |
| 4. STEAM OUTLET          | 10. HEATING ELEMENT      | 16. RELAY                 |
| 5. PRESSURE RELIEF VALVE | 11. 221 F HI-LIMIT       | 17. WATER LEVEL SENSOR    |
| 6. WATER FILL VALVE      | 12. TRANSFORMER          |                           |

INSTALLATION & USER GUIDE

# CARE & USE FOR THE CONTROL PANEL

1. Use soft cloth with a little soap water to clean the control panel.
2. Do not use crude cleaning tools.
3. If the decorating facade is damaged, contact service electrician to change it.

Do not install any SteamSpa controls without reading and understanding the SteamSpa generator Installation and Instruction manual. Failure to read and understand these instructions will result in inoperative control, generator, hazardous overheating, and/or inadequate heating of the steam room.

Do not route control wiring inside or close to power lines conduit, hot water or steam piping. Doing so may result in an inoperative control, generator, and/or hazardous installation.

Do not install SteamSpa controls with other than SteamSpa compatible steam generators. Doing so may result in possible generator damage or inoperative installation.

Single Control Panel with Temperature sensor must be installed inside bathing area 5 feet above floor. Do not install Control directly above Steam Head or below shower head but rather in the seating area on a vertical wall. Doing so may result in improper temperature reading and/or inoperable control.

Dual Control Panel with Temperature sensor in Master Control must be installed inside bathing area 5 feet above floor. Do not install Control directly above Steam Head or below shower head but rather in the seating area on a vertical wall. Doing so may result in improper temperature reading and/or inoperable control. Slave Control installation location is designed to be installed outside the steam room.

Turn power to the steam generator off before connecting the control to the generator. Failure to turn the power off generator prior to connecting controls will result in an inoperable control.

Discontinue use of the steam generator or control if the steam generator is damaged. Continue to do so may result in an inoperative or hazardous installation.

# CONTROLLER BOX CONTENT

- Control panel
- Steam nozzle
- User guide
- Controller cable wire (20 feet)

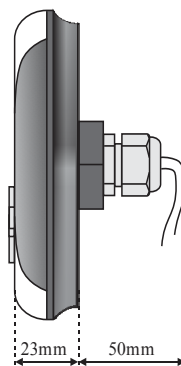



# CONTROL PANEL INSTALLATION INSTRUCTIONS

## STEP ONE

Determine the installation location of the control panel. The master control panel is designed to be installed in the steam room only, please install:

1. 4-5 feet from the ground.
2. Keep away from the steam head and do not expose under the direct spray of steam.
3. Install in the perpendicular wall.
4. The position of installation should facilitate easy operation and convenient wiring.

The controller wire is 1.6 feet long with a controller lengthen wire of 20 feet max. The installation of the controller should be in a position not more than 25 feet from the steam generator.

## STEP TWO

Drill a round hole of 1 inch in diameter in a chosen position.

## STEP THREE

Pull control panel wire inside steam room through opening connect it to the lengthened wire and then to the steam generator and connect with the corresponding wire in the generator. Connecting the wire of control panel outside room to the wire of control panel inside the room. When connecting wires please follow arrows on connector heads for proper connection. Failure to do so will result in damaging of control pins.

## STEP FOUR

Start the power supply of steam generator, check and adjust connection, check each item on the page to make sure all functions work well.

**IMPORTANT!** Before adjusting the control panel, make sure the steam generator is shut off otherwise the control panel may get damaged.

## STEP FIVE

Remove the adhesive paper from Control Panel. To achieve proper adhesion, make sure surface clean, dry and free of dust.

**IMPORTANT!** Do not over extend or clip control panel wire as it may cause possible damage.

## STEP SIX

Run a bead of silicone around adhesive gasket. Press Control Panel against wall at a 12 O'clock position until firmly adhered to surface.

**IMPORTANT!** Please do not apply an excessive amount of silicone. Just enough to provide a moisture seal should suffice.

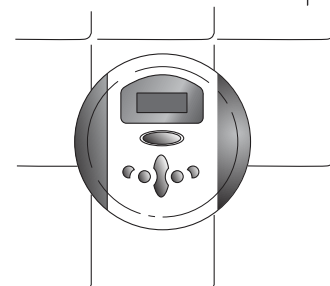
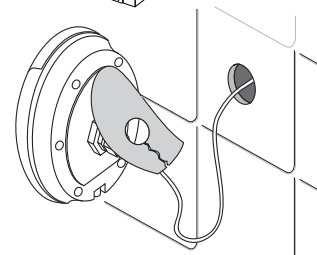
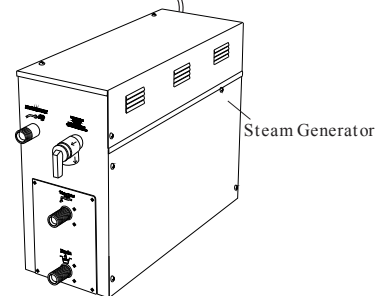
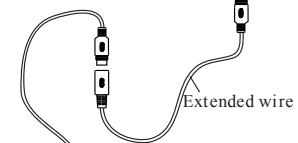
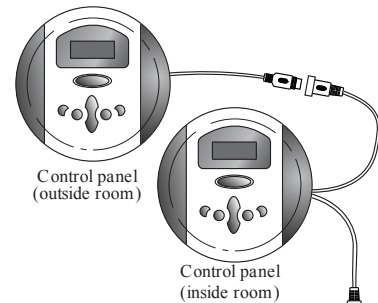
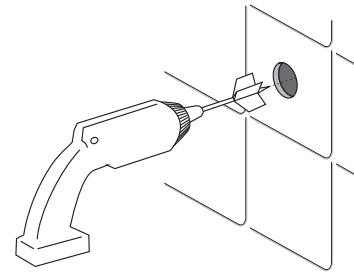

# TESTING THE MACHINE

1. Make sure the power switch of the control panel is turned on (the control panel displays ---), and the water supply valve will open.
2. Press the steam switch, (☺), the control panel will display the temperature of the environment, the steam engine begins to input water to start the steam function, and while opening the steam, press the (☹) button to open light function.
3. When there is steam output, press (☹) again, the steam will stop and the light will go off automatically.
4. Press the (☺) button to start the steam, the steam will come out of the steam generator in no more than 1 minute. Afterwards, the steam generator will supply water about every minute, the steam will decrease but not stop, and about 10 seconds later the steam will come out normally. As time goes on, the temperature displayed in the control panel will rise with the temperature in the room before it stops and stays at the set temperature.
5. Based on different requirements of the user for temperature and steam time, the control panel can adjust temperature and steam time. While testing the machine, set the time to be 30 minutes and the temperature to be 120F.
6. When the set steam time is due, the system will shut off the steam and light function automatically to stop water input and steam production.
7. 10 minutes after the steam is shut off, the system will start drainage automatically for 7 minutes. After testing the machine and it is working properly. Then the machine can be operated normally.

**WARNING!** Do not dismantle the safety pressure decrease valve arbitrarily.

**IMPORTANT!** Do not switch the water input pipe when the steam generator is working.

## CONTROL PANEL DIAGRAM

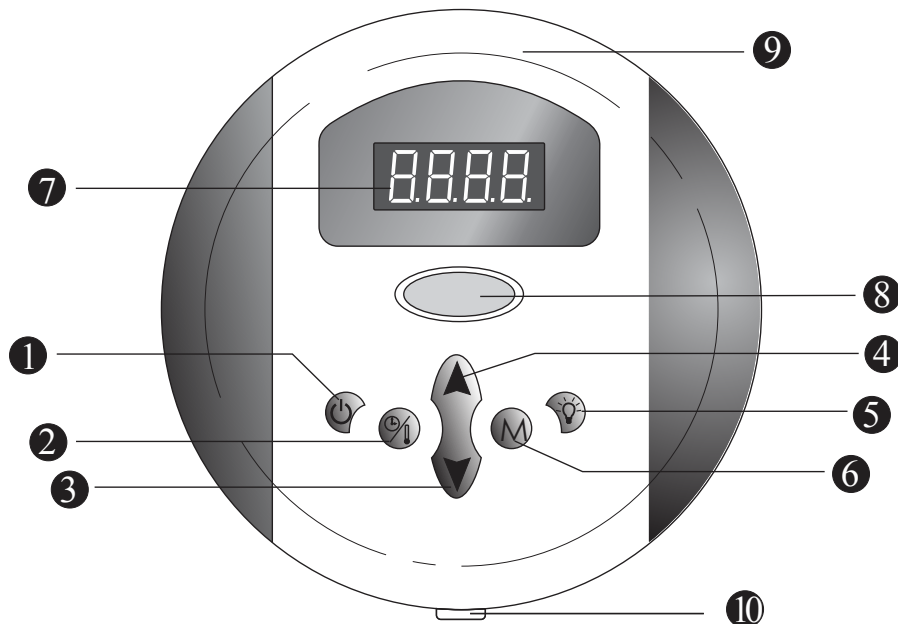

1. POWER ON/OFF
2. TIME/TEMP SET
3. TIME/TEMP DECREASE
4. TIME/TEMP INCREASE
5. LIGHT ON/OFF

6. MEMORY (MEMORY ONLY ON DUAL SYSTEMS)
7. DIGITAL DISPLAY SCREEN
8. STEAMSPA LOGO
9. FRONT DECORATIVE BEZEL

10. TEMP SENSOR

# CONTROL PANEL OPERATION





The control panel has a digital temperature control system which can start, stop or pause in the preset time to keep the temperature at the set number.

## ON/OFF



When system is powered, all functions will still not be activated and remain in a waiting state. Digital tube will display ---- (Fig.1). In the waiting state, press the  button to turn on the system and activate steam function. System will recall last use steam time and TEMP, system begins to count down. During this time, the digital tube will display the ambient temperature. Steam temperature display range is 32° F-140° F.

When the actual temperature is lower or equal to 32° F, the digital tube will display 32° F. When the actual temperature is higher or equal to 140° F, the digital tube will display 140° F. The last digit displays as the *F* unit (Fig.2) of Fahrenheit temperature. The default steam time is 30 minutes. When lacking water, the heating elements will stop heating and the water inlet valve will work automatically. If there is no water detected in 5 seconds or the water coming in does not reach the set point in 15 seconds, the digital tube will display *EO* (Fig.3) to indicate an error of not enough water cycling. If there is enough water cycling, the steam function will return to normal. When the steam function is started, if the ambient room temperature is higher than the set point, the heating element will stop heating, the digital tube will flash to display the current environment temperature; when the environment temperature is lower than the set point, the heating element will work again, the digital tube will display current room temperature normally. When the system is on, press  button to turn off the system, or when the steam time is over the system shuts off. 10 minutes after the system is shut off, the drainage function will be started automatically for 7 minutes.

## TIME AND TEMPERATURE SETTING

When system is on,  press button twice, system will cycle switch in time setting, TEMP setting and ambient TEMP display state (Fig.4). When the digital tube displays dashes across the screen it will allow you to set the duration of the steam bath. During this time, press  or  to adjust steam time. Its range is 1-60 minutes, with 1 minute intervals. If there is no adjustment in 5 seconds, the system will exit time setting automatically and the LED will display current ambient TEMP. When the LED screen shows number and TEMP unit F, it is displaying the indoor ambient temperature. When the TEMP unit F flashes on the LED screen, it means the system is in the steam TEMP setting state. During this time, press  or  to adjust steam TEMP (Fig.5). Its range is 50°~130° Fahrenheit, with 1° increments. If no adjustment is done in 5 seconds, the system will exit the TEMP setting automatically and the LED screen will display ambient temperature.

## MEMORY FUNCTION

When system is on, it recalls the last time used with the steam time and TEMP. After adjusting steam time and steam TEMP, press  for about 1.5 seconds to adjust time and TEMP parameters as current state. The LED screen will show current settings. When system is on, press  to switch modes between SET1 and SET2. The LED screen displays the current mode.

## LIGHT FUNCTION

When the machine is started, press  button to turn on/off light function. When the light is turned on, the digital tube will temporarily display *LON* (Fig.6). When the light is turned off, the digital tube will temporarily display *L0FF* (Fig.7). Screen will turn to display ambient TEMP if no operation is selected in 5 seconds.



Fig. 1



Fig 2



Fig. 3

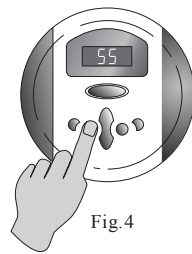

Fig. 4

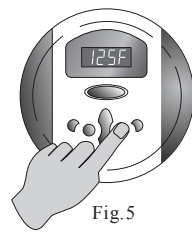

Fig. 5







Fig. 6



Fig. 7

# TESTING THE MACHINE

1. Make sure the power switch of the control panel is turned on (the control panel displays ---), and the water supply valve will open.
2. Press the steam switch, , the control panel will display the temperature of the environment, the steam engine begins to input water to start the steam function, and while opening the steam, press the  button to open light function.
3. When there is steam output, press  again, the steam will stop and the light will go off automatically.
4. Press the  button to start the steam, the steam will come out of the steam generator in no more than 1 minute. Afterwards, the steam generator will supply water about every minute, the steam will decrease but not stop, and about 10 seconds later the steam will come out normally. As time goes on, the temperature displayed in the control panel will rise with the temperature in the room before it stops and stays at the set temperature.
5. Based on different requirements of the user for temperature and steam time, the control panel can adjust temperature and steam time. While testing the machine, set the time to be 30 minutes and the temperature to be 120F.
6. When the set steam time is due, the system will shut off the steam and light function automatically to stop water input and steam production.
7. 10 minutes after the steam is shut off, the system will start drainage automatically for 7 minutes. After testing the machine and it is working properly. Then the machine can be operated normally.

**WARNING!** Do not dismantle the safety pressure decrease valve arbitrarily.

**IMPORTANT!** Do not switch the water input pipe when the steam generator is working.

## CONTROL PANEL DIAGRAM

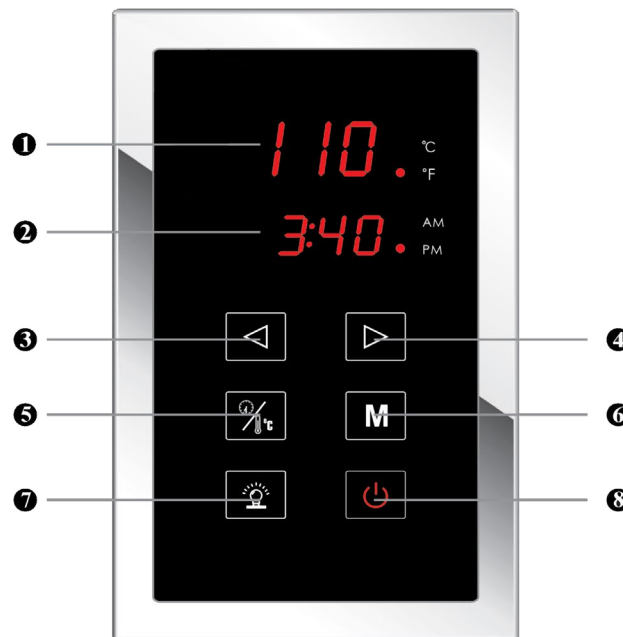



- |                        |                 |
|------------------------|-----------------|
| 1. TEMP DISPLAY SCREEN | 6. MEMORY       |
| 2. TIME DISPLAY SCREEN | 7. LIGHT ON/OFF |
| 3. TIME/TEMP DECREASE  | 8. POWER ON/OFF |
| 4. TIME/TEMP INCREASE  |                 |
| 5. TIME/TEMP SET       |                 |

# CONTROL PANEL OPERATION





The control panel has a digital temperature control system which can start, stop or pause in the preset time to keep the temperature at the set number.

## ON/OFF



When system is powered, all functions will still not be activated and remain in a waiting state. Digital tube will display ----. In the waiting state, press the  button to turn on the system and activate steam function. System will recall last use steam time and TEMP, system begins to count down. During this time, the digital tube will display the ambient temperature. Steam temperature display range is 32° F-140° F.

When the actual temperature is lower or equal to 32° F, the digital tube will display 32° F. When the actual temperature is higher or equal to 140° F, the digital tube will display 140° F. The last digit displays as the F unit of Fahrenheit temperature. The default steam time is 30 minutes. When lacking water, the heating elements will stop heating and the water inlet valve will work automatically. If there is no water detected in 5 seconds or the water coming in does not reach the set point in 15 seconds, the digital tube will display **E0** to indicate an error of not enough water cycling. If there is enough water cycling, the steam function will return to normal. When the steam function is started, if the ambient room temperature is higher than the set point, the heating element will stop heating, the digital tube will flash to display the current environment temperature; when the environment temperature is lower than the set point, the heating element will work again, the digital tube will display current room temperature normally. When the system is on, press  button to turn off the system, or when the steam time is over the system shuts off. 10 minutes after the system is shut off, the drainage function will be started automatically for 7 minutes.

## TIME AND TEMPERATURE SETTING

When system is on,  press button twice, system will cycle switch in time setting, TEMP setting and ambient TEMP display state. When the digital tube displays dashes across the screen it will allow you to set the duration of the steam bath. During this time, press  or  to adjust steam time. Its range is 1-60 minutes, with 1 minute intervals. If there is no adjustment in 5 seconds, the system will exit time setting automatically and the LED will display current ambient TEMP. When the LED screen shows number and TEMP unit F, it is displaying the indoor ambient temperature. When the TEMP unit F flashes on the LED screen, it means the system is in the steam TEMP setting state. During this time, press  or  to adjust steam TEMP. Its range is 50°~130° Fahrenheit, with 1° increments. If no adjustment is done in 5 seconds, the system will exit the TEMP setting automatically and the LED screen will display ambient temperature.

## MEMORY FUNCTION

When system is on, it recalls the last time used with the steam time and TEMP. After adjusting steam time and steam TEMP, press  for about 1.5 seconds to adjust time and TEMP parameters as current state. The LED screen will show current settings. When system is on, press  to switch modes between SET1 and SET2. The LED screen displays the current mode.

## LIGHT FUNCTION

When the machine is started, press  button to turn on/off light function. When the light is turned on, the digital tube will temporarily display **LOON**. When the light is turned off, the digital tube will temporarily display **LOFF**. Screen will turn to display ambient TEMP if no operation is selected in 5 seconds.

# INSTALLATION OF CONTROL PANEL

Recess mount into wall

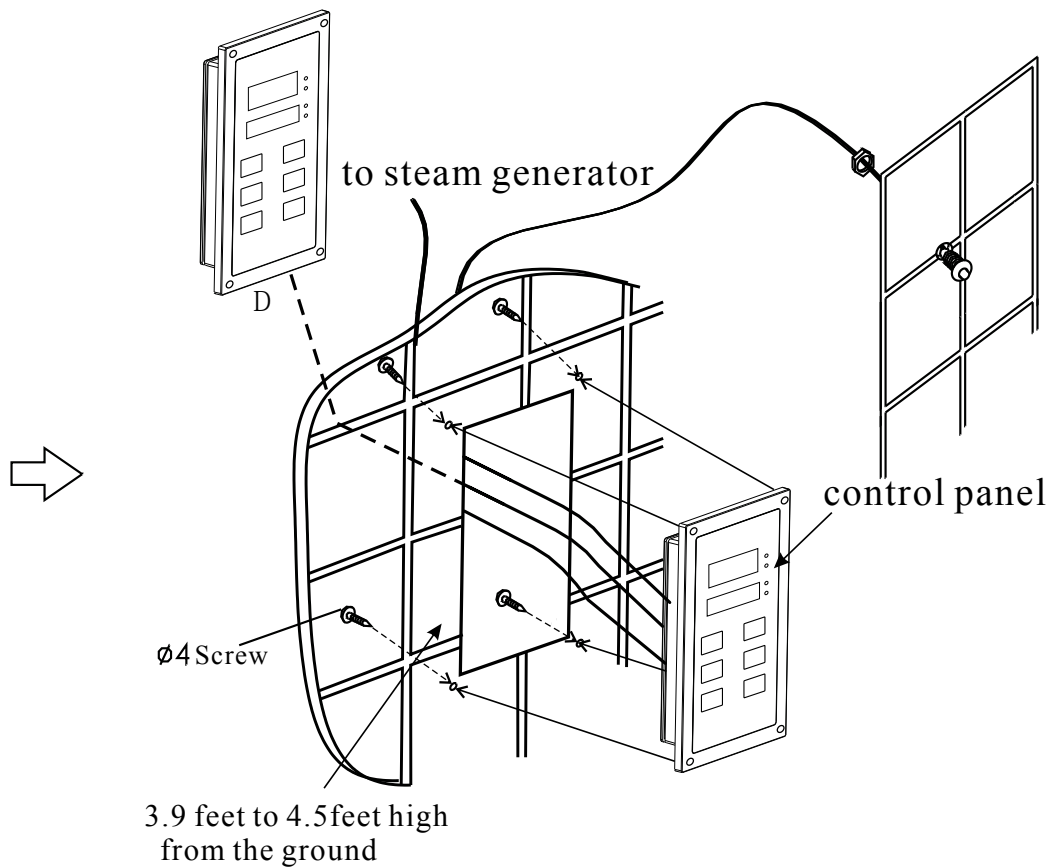
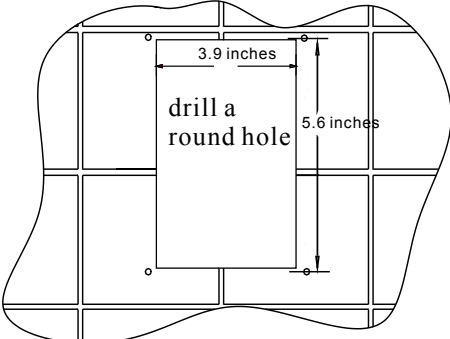

INSTALLATION & USER GUIDE

# INSTALLATION OF CONTROL PANEL

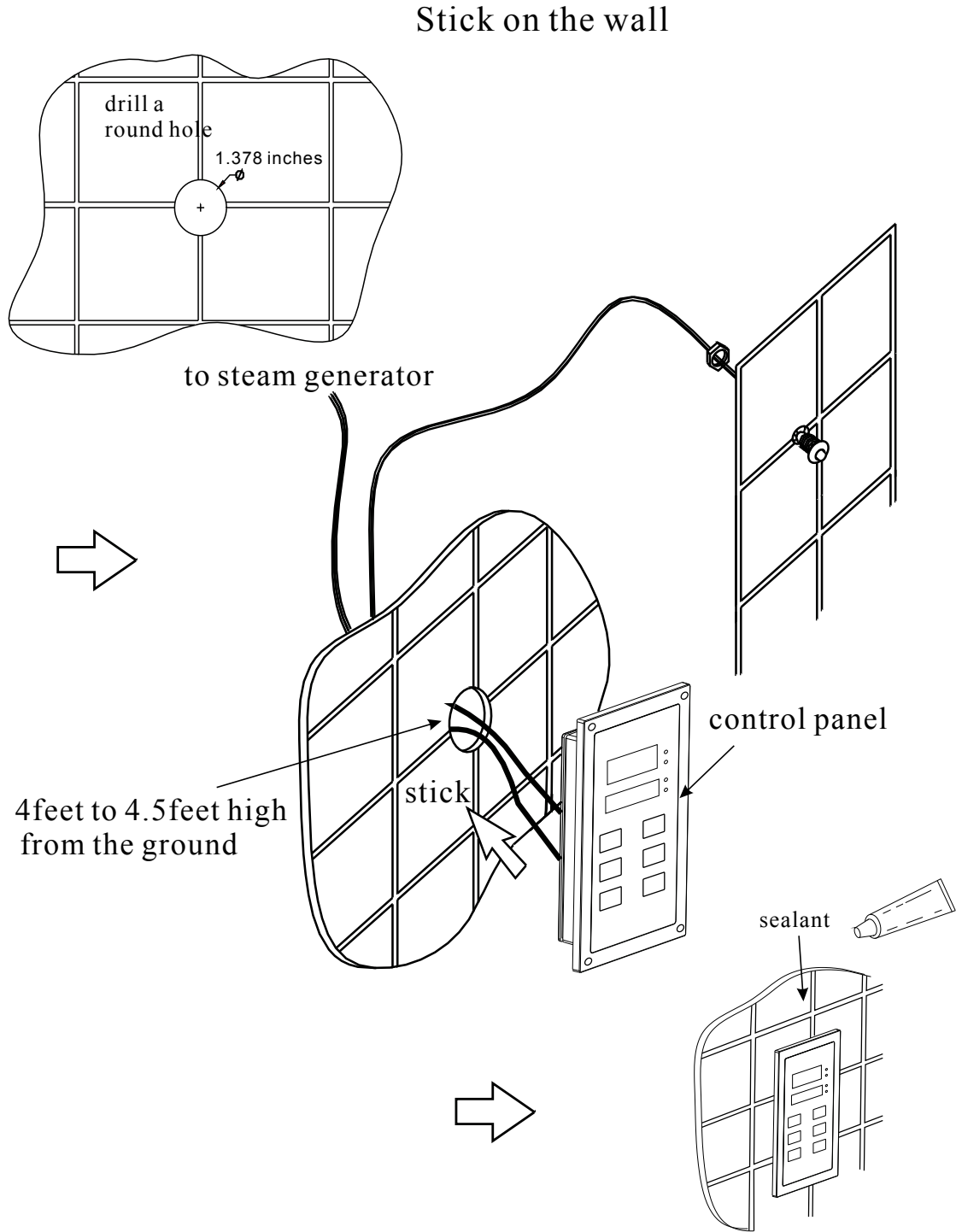

INSTALLATION & USER GUIDE

# INSTALLATION OF TEMPERATURE SENSOR

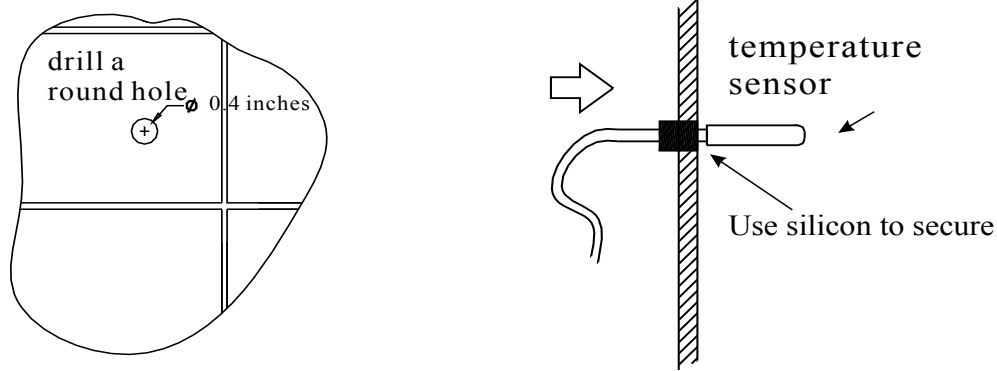

## CONTROLLER SIZE AND WATERPROOF RATING

Control panel model	GS1090C(single panel)	GS1090D(dual panel)
Panel size (length*width*height)	5.9x3.5x1 inches	5.9x3.5x1 inches
Waterproof rating	IP54	IP54

INSTALLATION & USER GUIDE



# STEAM GENERATOR MAINTENANCE

**IMPORTANT!** The steam generator automatically performs a water discharge operation after each use.

1. Wait for the completion of automatic water discharge after each time using the steam generator to make sure the water in the tank is discharged completely before cutting off power supply.
  2. There should not be any leakage or damage among the steam generator, steam nozzle, components and pipes. They should be checked and repaired annually.
  3. Clean the water supply pipes of the steam generator once a year.
  4. Check all the faucet connections, to ensure whether they are tight and not damaged due to overheat.
  5. Check the sediments accumulated in the water tank and electric heating tube. If the sediment is thick, dispose of it in time (using diluted lemon acid to soak for 15-30 minutes).
  6. It is recommended that the water sensor prong gets clean once every six month.
1. Remove the casing of the generator.
  2. Locate the water sensor.
  3. Label each electrical connections then carefully remove all connections.
  4. With a wrench or a 32mm ratchet socket carefully unscrew the water sensor.
  5. Thoroughly clean any residue buildup accumulated on the prong.

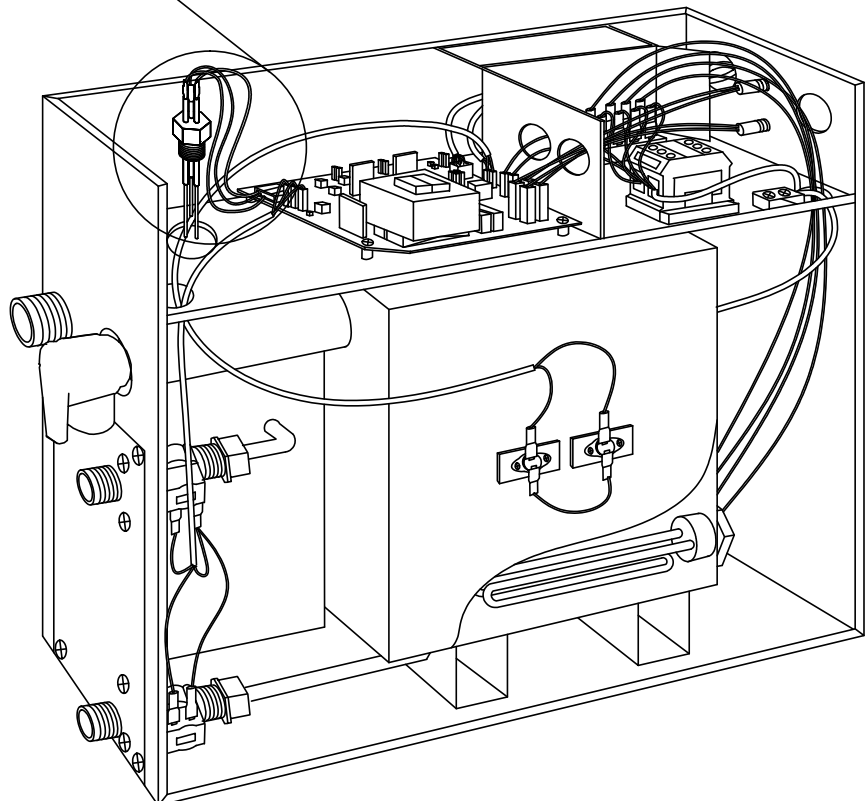
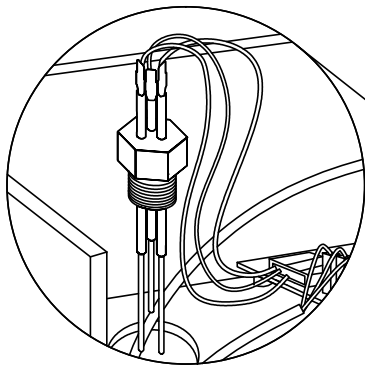

# TROUBLESHOOTING

PROBLEM	POSSIBLE CAUSES	SOLUTIONS
The machine does not start when powered	<ol style="list-style-type: none"> <li>1. Burned out fuse</li> <li>2. The electrical wiring became loose</li> <li>3. Control panel connection loose</li> </ol>	<ol style="list-style-type: none"> <li>1. Replace fuse (0.8A/240V)</li> <li>2. Cut power Supply and reconnect wiring</li> <li>3. Reconnect control panel and reset Controller (turn off and on)</li> <li>4. Controller (turn off and on)</li> </ol>
Breakers are tripping	<ol style="list-style-type: none"> <li>1. The wire connector is dampened or damaged</li> <li>2. Damaged heating element</li> </ol>	<ol style="list-style-type: none"> <li>1. Check whether the wire connector is dampened or damaged, and dry if dampened</li> <li>2. Replace heating element</li> </ol>
When the machine is started, hot water comes out with little or no steam	<ol style="list-style-type: none"> <li>1. Bad water drainage valve</li> </ol>	<ol style="list-style-type: none"> <li>1. Replace water drainage valve</li> </ol>
The display screen on the control panel does not display anything	<ol style="list-style-type: none"> <li>1. The control panel wire is not connected properly</li> <li>2. Trouble with generator motherboard</li> </ol>	<ol style="list-style-type: none"> <li>1. Check whether the connection plug between the control panel and the generator has become loose, and whether the power circuitry has good contact</li> <li>2. Replace the motherboard</li> </ol>
Water leakage	<ol style="list-style-type: none"> <li>1. The water pipe connector becomes loose or pipe is broken.</li> <li>2. Water leakage in the water input valve or the water drainage valve</li> </ol>	<ol style="list-style-type: none"> <li>1. Tighten the loose connection or change the broken pipe</li> <li>2. Change the water input valve or the water drainage valve</li> </ol>
No steam when starting the machine	<ol style="list-style-type: none"> <li>1. No electricity</li> <li>2. No water</li> <li>3. The set temperature is too low</li> <li>4. Wiring connection problem</li> </ol>	<ol style="list-style-type: none"> <li>1. Check the power supply and connections</li> <li>2. Check the water input pipe and water input valve</li> <li>3. Reset the temperature</li> <li>4. Check wiring connection and tighten</li> </ol>
The steam does not come out, the water sounds in the machine	<ol style="list-style-type: none"> <li>1. Possible steam pipe blockage</li> </ol>	<ol style="list-style-type: none"> <li>1. Cut power supply and check blockage in steam pipe</li> </ol>
Light doesn't turn on	<ol style="list-style-type: none"> <li>1. Bad LED light bulb</li> <li>2. Wiring connection improperly connected or light cable damage</li> </ol>	<ol style="list-style-type: none"> <li>1. Change LED light bulb</li> <li>2. Tighten connection or replace light cable</li> </ol>
Cold water is coming from the steam head	<ol style="list-style-type: none"> <li>1. The water sensor cable is loose or water level sensor is defected</li> <li>2. The main PC board is defected</li> </ol>	<ol style="list-style-type: none"> <li>1. Make sure that the water level cable isn't loose if the cable is well connected replace the water sensor</li> <li>2. Replace the main board</li> </ol>
Hot water is coming from the steam head	<ol style="list-style-type: none"> <li>1. The water inlet valve may have residue buildup inside</li> </ol>	<ol style="list-style-type: none"> <li>1. Try to clean the water inlet valve by switching on/off a few times to dislodge the buildup</li> <li>2. Replace the water inlet value</li> </ol>

PROBLEM	POSSIBLE CAUSES	SOLUTIONS
Receiving an error "E1" on the control panel	1. The signal that transfers between the control panel and generator has a problem	1. Check the connection on the control cable to make sure all 13 pins are functional
Receiving an error "E0" on the control panel	1. Lack of water in the tank	1. Check the connection on the control cable to make sure all 13 pins are functional
The control panel shows the temperature, but does not go on	1. The water level sensor cable or the cable from the relay to element is loose	1. Make sure all cables to the heating elements are well connected



# TECHNICAL PARAMETERS

Type	4.5KW	6KW	7.5KW	9KW	10.5KW	12KW	15KW
Power (KW)	4.5	6	7.5	9	10.5	12	15
Voltage (V)	240	240	240	240	240	240	240
Current (A)	19	25	32	38	44	50	63
Errors Range	+10%	+10%	+10%	+10%	+10%	+10%	+10%
Anti-Static Constant	>1500V	>1500V	>1500V	>1500V	>1500V	>1500V	>1500V
Insulation Resistance	>20M Ω	>20M Ω	>20M Ω	>20M Ω	>20M Ω	>20M Ω	>20M Ω
Head Lamp	~12V/3W	~12V/3W	~12V/3W	~12V/3W	~12V/3W	~12V/3W	~12V/3W
Temperature Range (°F)	50-130	50-130	50-130	50-130	50-130	50-130	50-130
Time Set Range (min)	1-60	1-60	1-60	1-60	1-60	1-60	1-60
Steam Press (psi)	3	4	4	4	5	5	5
Steam Vol. (cu. in./min)	9	11	13	16	19	21	25
Steam Spray Time (sec)	100-180	180-240	150-210	120-180	170-230	150-160	120-150
Water Vol. (cu. in.)	80	160	160	160	330	330	330
Applicable Space of the Room (cu. ft.)	90	150	225	300	400	450	500

**IMPORTANT!** The list above is for reference only. Actual checking and repairing should be based on national and local codes, ask professional service personnel to operate.

**IMPORTANT!** The parameter listed above will vary by geographical location and environment. Please consult a qualified designer and architect for more detailed use.

# WIRING DIAGRAMS

4.5KW

Control panel(outside room) Control panel(inside room)

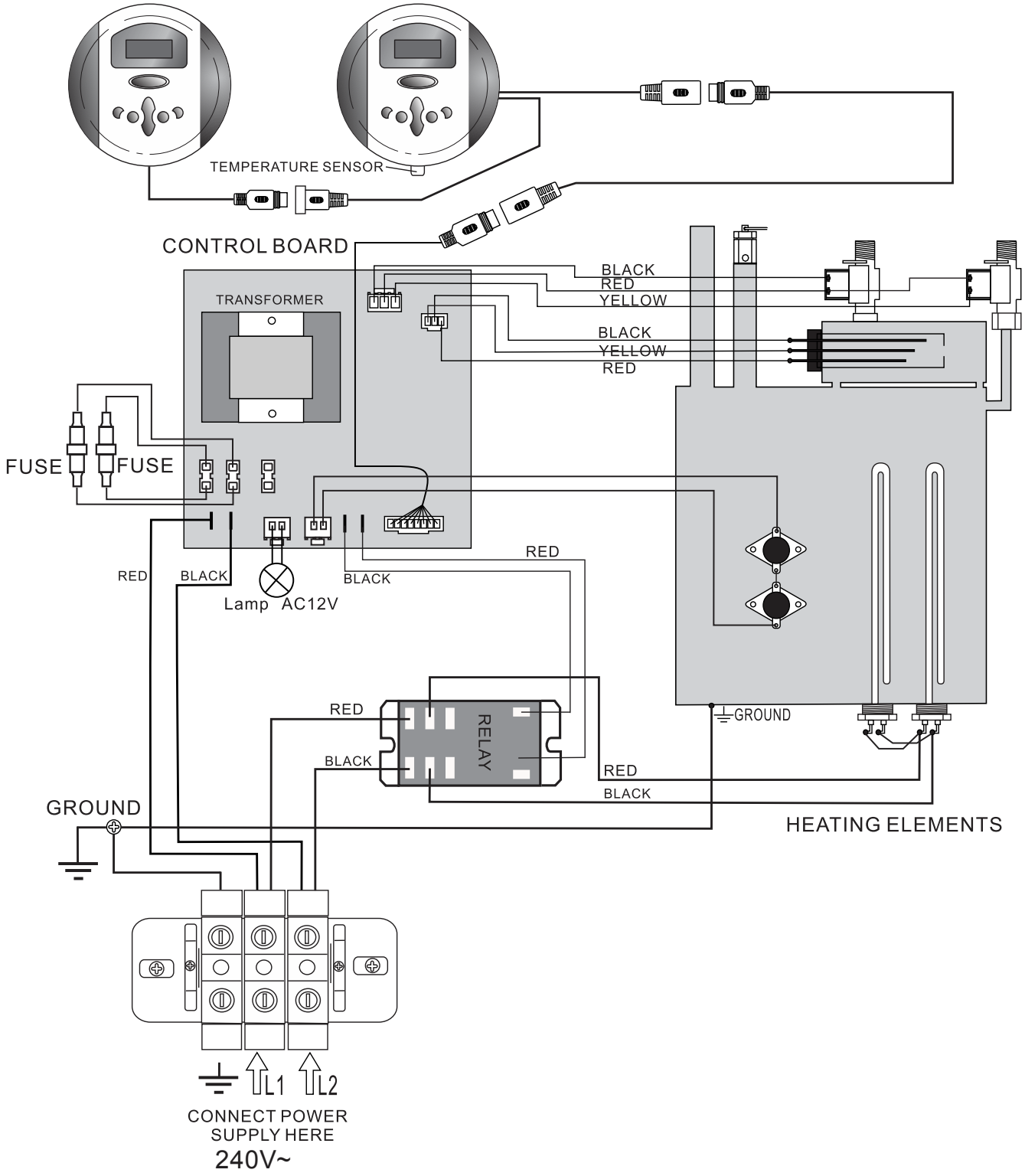

INSTALLATION & USER GUIDE

6KW

Control panel(outside room) Control panel(inside room)

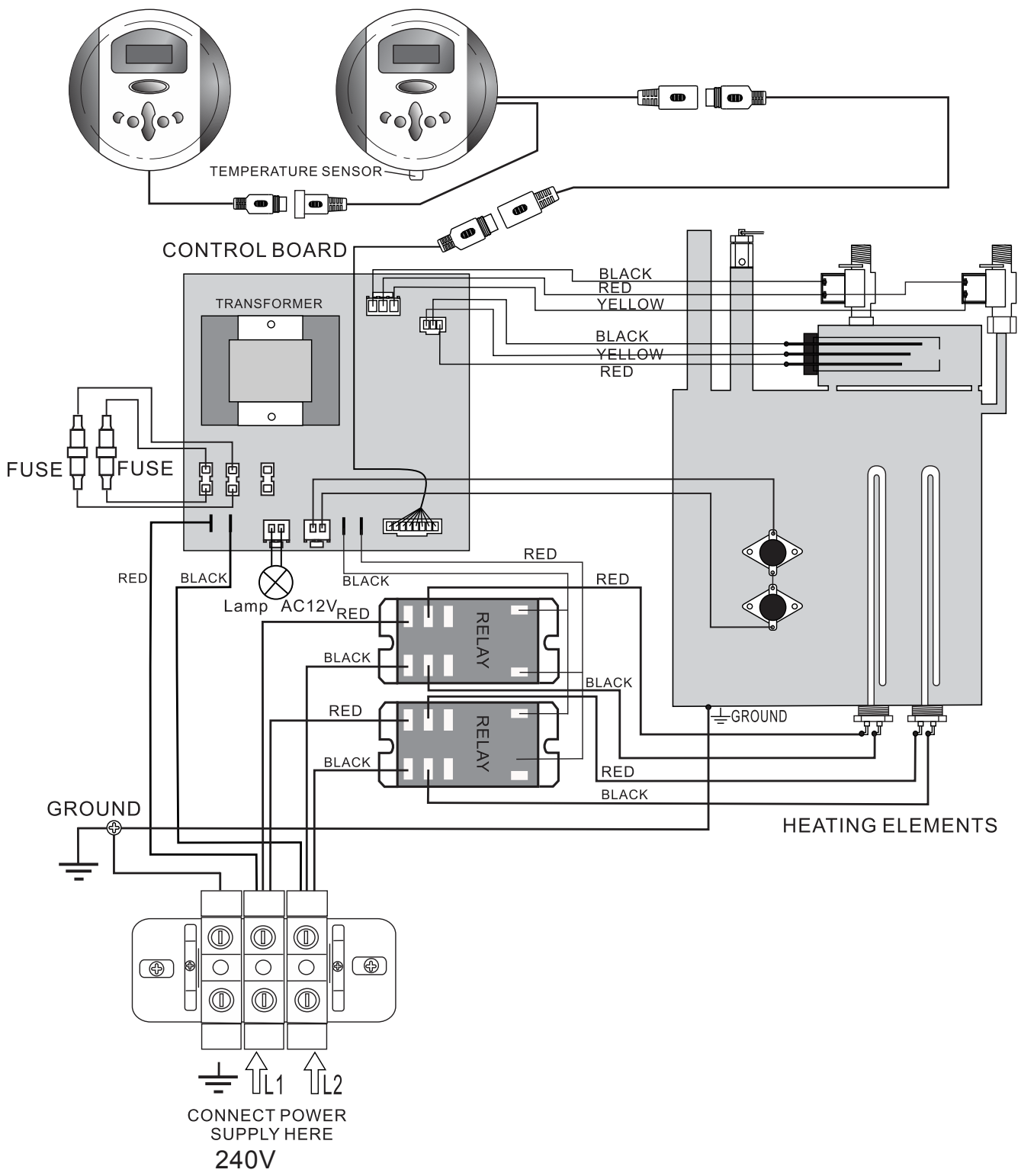

INSTALLATION & USER GUIDE

7.5KW & 9KW

Control panel(outside room) Control panel(inside room)

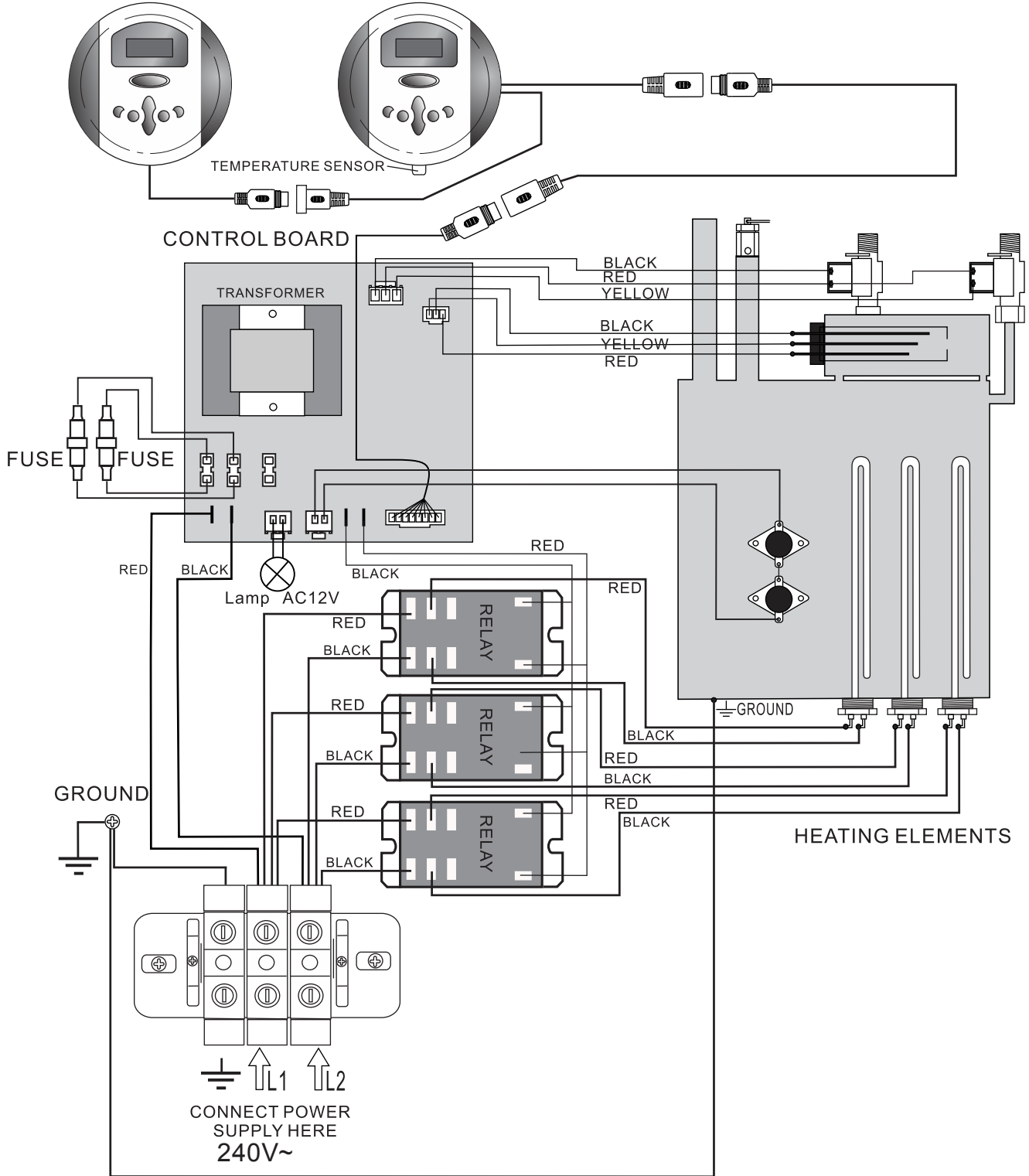



10.5KW & 12KW

Control panel(outside room) Control panel(inside room)

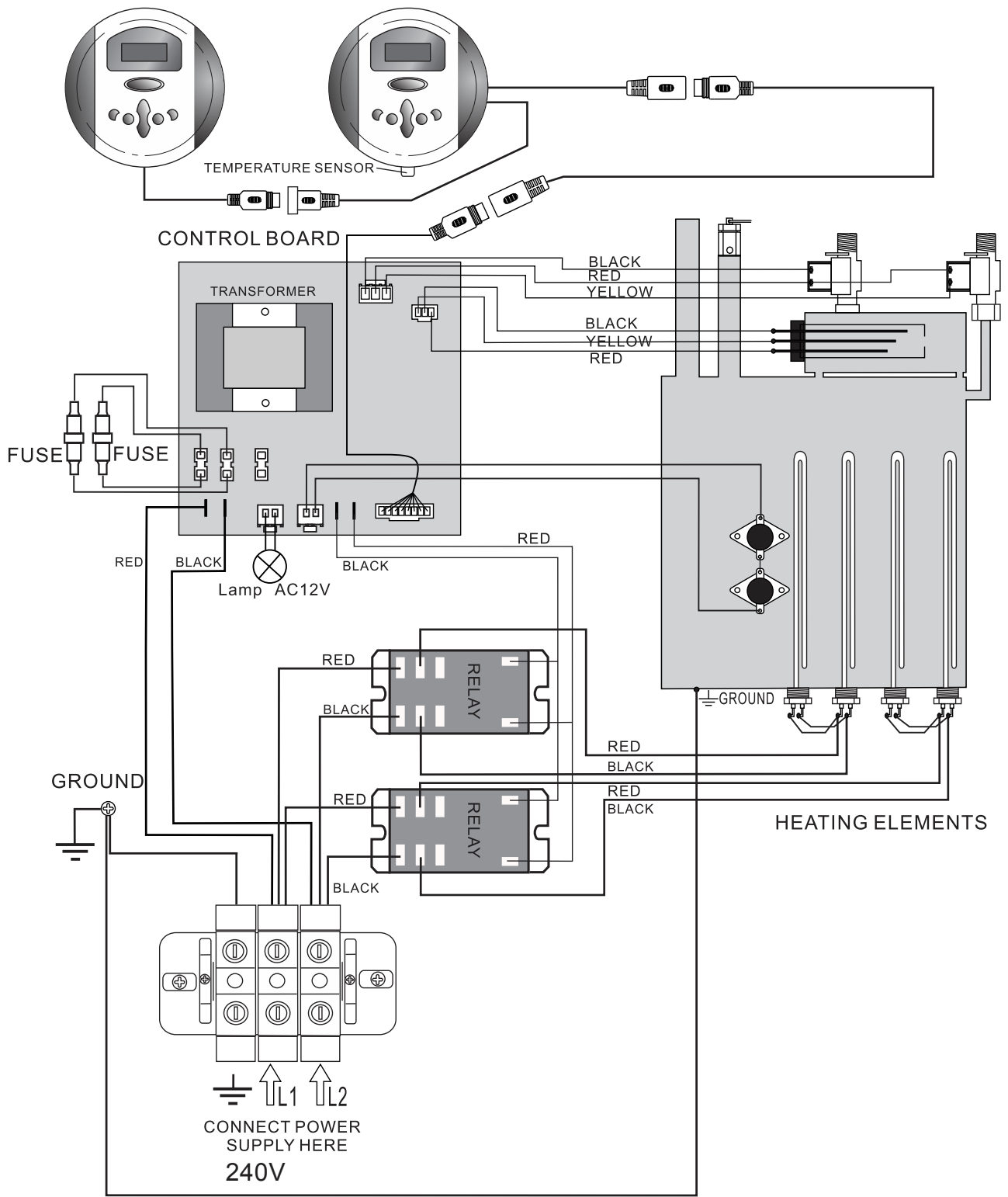

INSTALLATION & USER GUIDE

15KW

Control panel(outside room) Control panel(inside room)

