

# HILTI

**DSH 700**  
**DSH 700-X**  
**DSH 900**  
**DSH 900-X**

English  
Français  
Español

en  
fr  
es



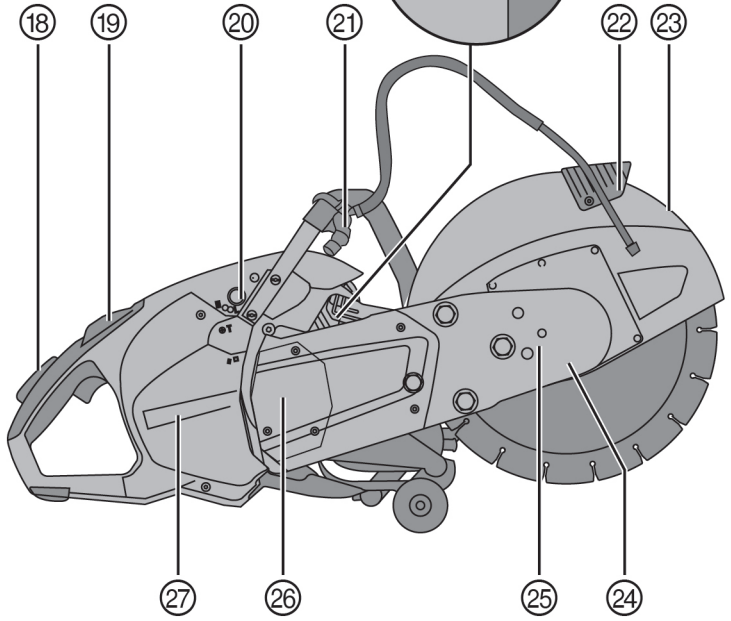
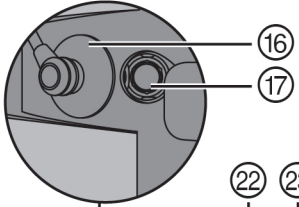
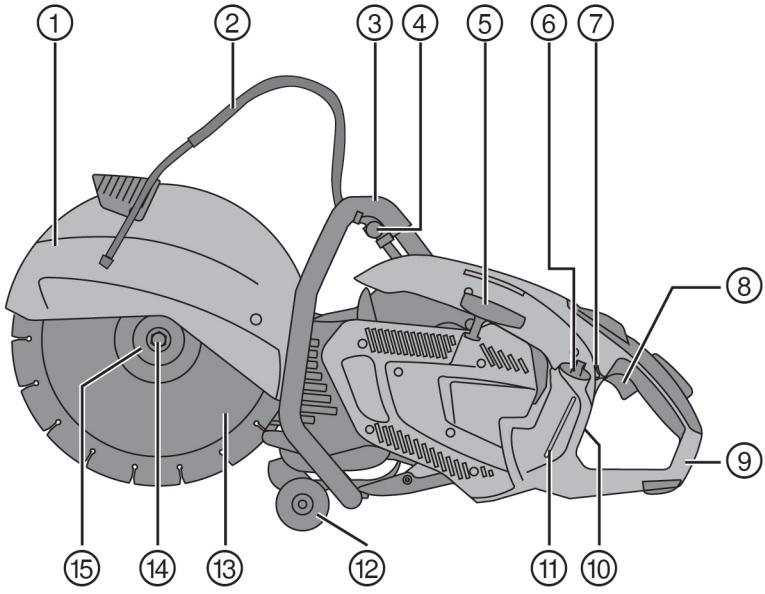

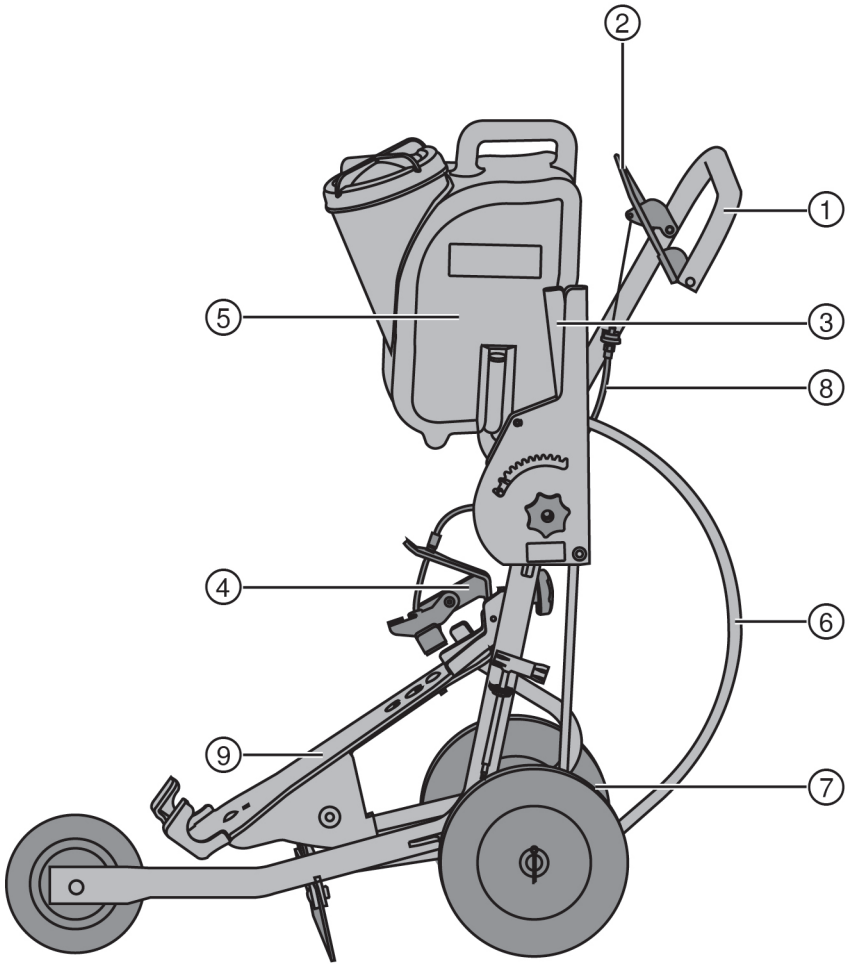

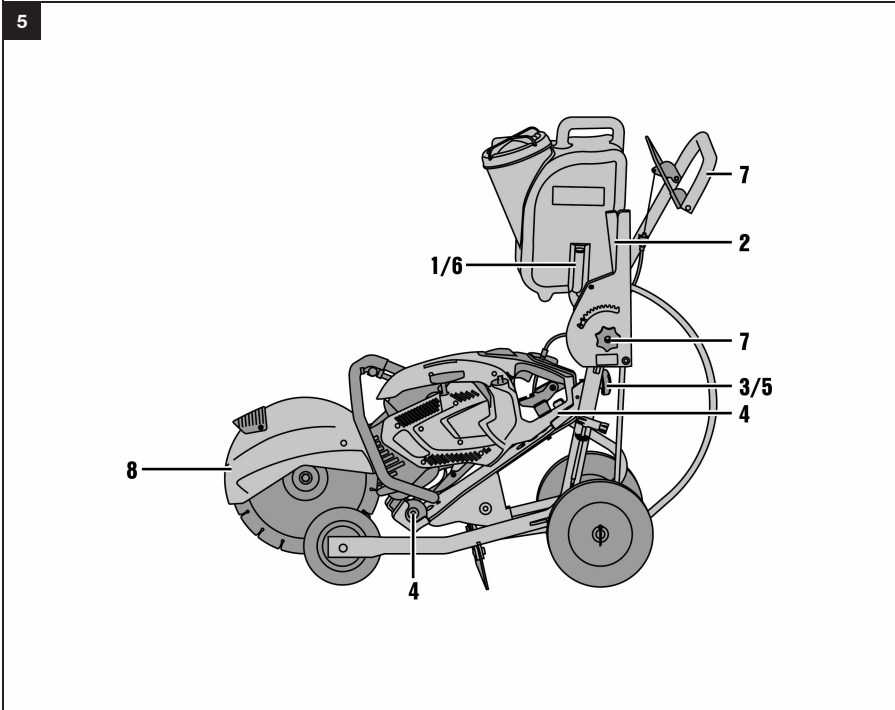
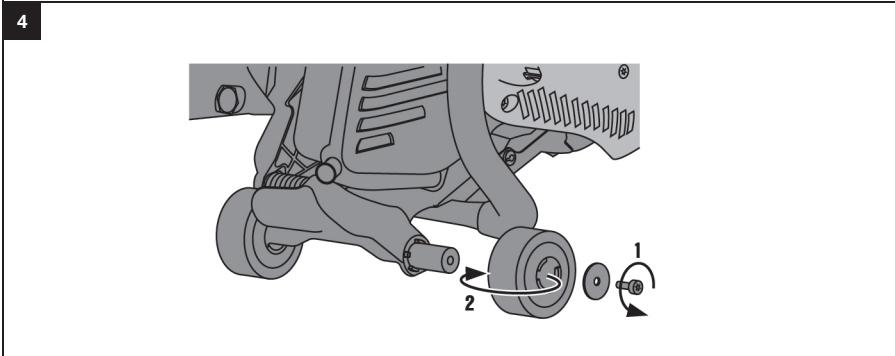
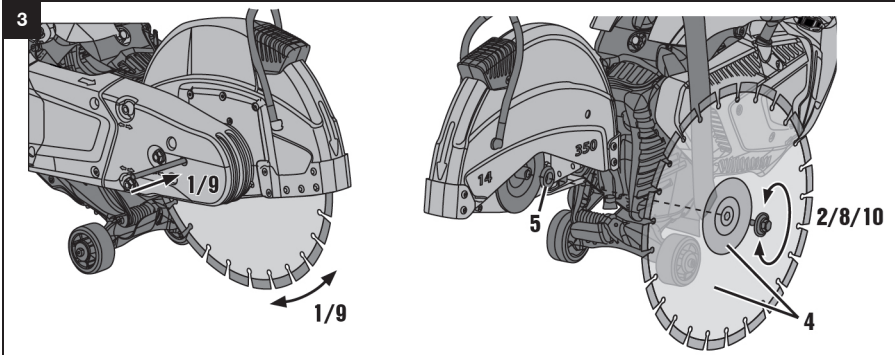

6

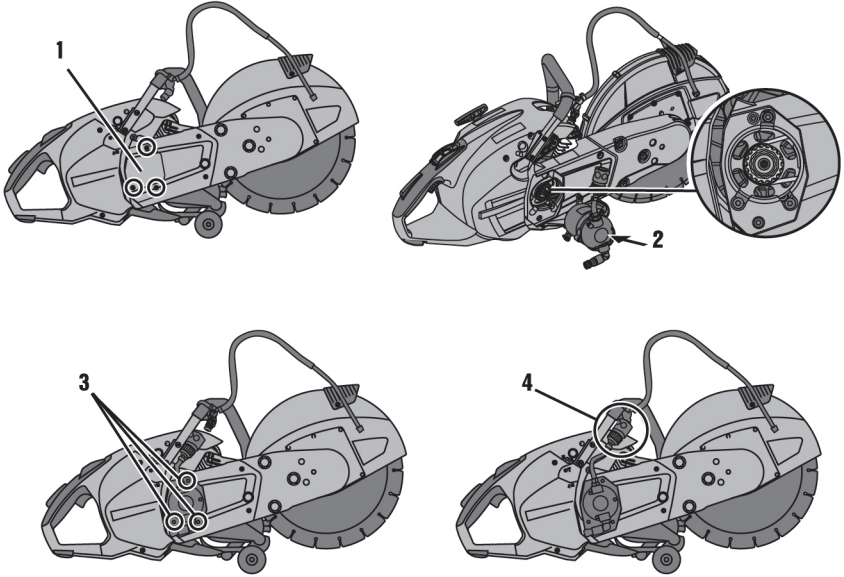

7

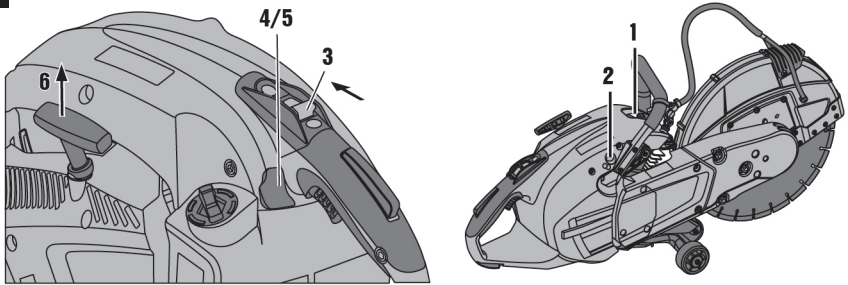

8

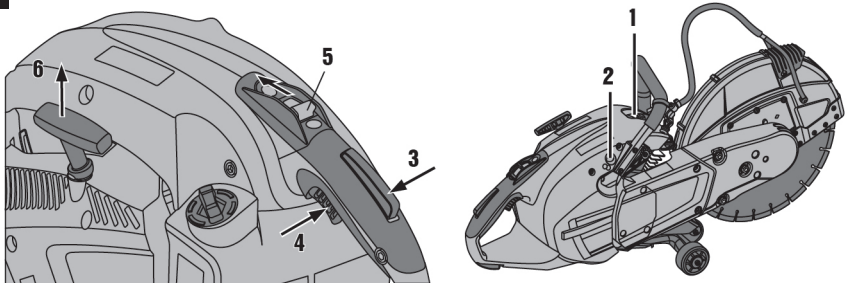

9

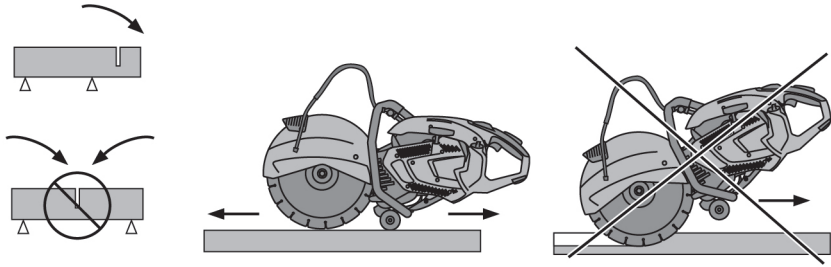

10

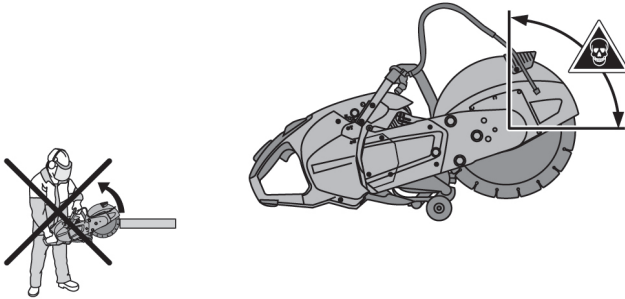

11

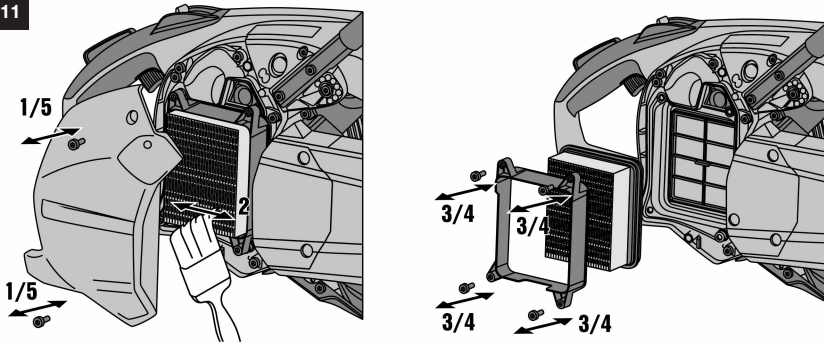

12

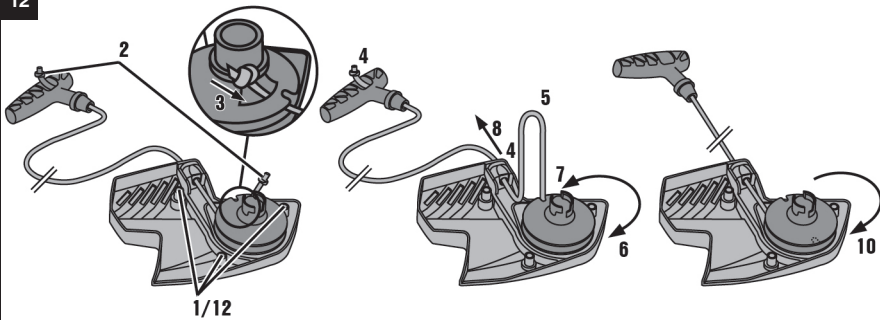

13

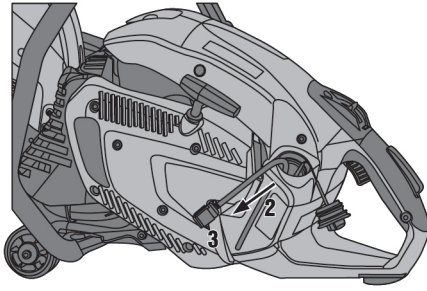

14

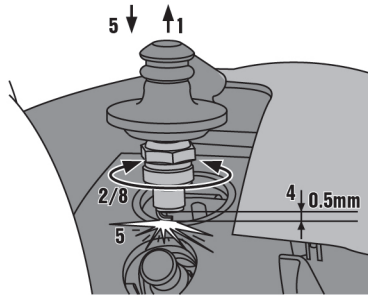

15

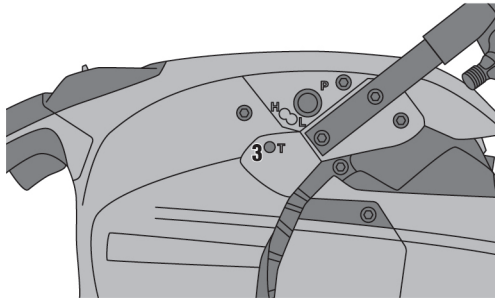



## 1 Information about the documentation

### 1.1 Explanation of signs used



#### 1.1.1 Warnings

Warnings alert persons to hazards that occur when handling or using the product. The following signal words are used in combination with a symbol:

	<b>DANGER!</b> Draws attention to imminent danger that will lead to serious personal injury or fatality.
	<b>WARNING!</b> Draws attention to a potentially dangerous situation that could lead to serious personal injury or fatality.
	<b>CAUTION!</b> Draws attention to a potentially dangerous situation that could lead to slight personal injury or damage to the equipment or other property.















#### 1.1.2 Mandatory signs

The following mandatory signs are used:

	Wear ear protection, eye protection, respiratory protection and a hard hat.
	Wear protective gloves
	Wear safety shoes.

#### 1.1.3 Symbols



The following symbols are used:

	Read the operating instructions before use.
	Instructions for use and other useful information
	Warning
	Rotation direction arrow on the guard
	Engine stop position
	Engine run position
	Primer bulb
	Full-throttle jet adjusting screw
	Idling jet adjusting screw
	Idling adjusting screw
	Fuel mixture
	Fuel tank cap turning direction (to open)
	Choke (only on DSH 700 or DSH 900)
	Half throttle (only on DSH 700 or DSH 900)







### 1.1.4 Illustrations

The illustrations in these operating instructions are intended to convey a basic understanding and may differ from the actual version of the product:



	These numbers refer to the illustrations at the beginning of the operating instructions.
3	The numbering in the illustrations reflects the order of the work steps in the illustration and may deviate from the numbering of work steps in the text.
	Item reference numbers are used in the overview illustration. In the product overview section, the numbers shown in the legend relate to these item reference numbers.
	Points to which particular attention must be paid (in the illustrations)

### 1.2 Adhesive labels on the machine

#### Warning signs

	Warning: Flying sparks present a fire risk.
	Warning: Risk of kickback.
	Warning: Don't inhale toxic vapors or exhaust fumes.
	Maximum arbor speed
	Warning: hot surface

#### Prohibition signs

	Don't use toothed cutting discs.
	Don't use damaged cutting discs.
	Smoking and naked flames prohibited.

### 1.3 About this documentation

- ▶ Read these operating instructions before the product is used or operated for the first time. This is a prerequisite for safe, trouble-free handling and use of the product.
- ▶ Observe the safety instructions and warnings printed in this documentation and on the machine.
- ▶ Always keep the operating instructions with the machine and make sure that the operating instructions are with the machine when it is given to other persons.

### 1.4 Product information

Hilti products are designed for professional use and may be operated, serviced and maintained only by trained, authorized personnel. This personnel must be informed of any particular hazards that may be encountered. The product and its ancillary equipment may present hazards when used incorrectly by untrained personnel or when used not as directed.

- ▶ Make a note of the designation and serial number printed on the identification plate in the following table.
- ▶ Always quote this information when you contact a Hilti representative or Hilti Service regarding questions about the product:

#### Product information

Abrasive disc cut-off saw	DSH 700   DSH 900
Generation:	01
Serial no.:	
Abrasive disc cut-off saw	DSH 700-X   DSH 900-X
Generation:	02
Serial no.:	

## 2 Safety

### 2.1 Safety instructions

In addition to the safety rules listed in the individual sections of these operating instructions, the following rules must be strictly observed at all times.

#### 2.1.1 Personal safety

- ▶ Use the right machine for the job. Do not use the machine for purposes for which it was not intended. Use it only as directed and when in technically faultless condition.
- ▶ Never tamper with or modify the machine in any way.
- ▶ The product may be used only by persons who are familiar with it, who have been trained on how to use it safely and who understand the resulting hazards. The product is not intended for use by children.
- ▶ Stay alert, watch what you are doing and use common sense when working with the product. Do not use the product while you are tired or under the influence of drugs, alcohol or medication. A moment of inattention while operating the product may result in serious personal injury.
- ▶ The user and any other persons in the vicinity must wear ANSI Z87.1 approved protective glasses, a hard hat, ear protection, protective gloves, protective footwear and breathing protection while the machine is in use.
- ▶ Always hold the machine with both hands on the grips provided. Keep the grips dry, clean and free from oil and grease.
- ▶ Never use the machine without the guard (hood). Adjust the guard to the correct position. The guard must be securely attached and positioned for maximum safety, so that the smallest possible part of the cutting disc is exposed to the operator. Take steps to ensure that any sparks created while the product is in use do not present a hazard. The guard helps to protect the operator from broken disc fragments, accidental contact with the disc and uncontrolled flying sparks.
- ▶ Before using the product, or if an obstacle is contacted while the product is in use, check the guard immediately for possible damage. Damaged or broken guards must be replaced immediately.
- ▶ Avoid touching rotating parts – risk of injury!
- ▶ Keep proper footing and balance at all times. This will allow you to control the product better, even in unexpected situations, for example, in the event of experiencing kickback or rotational forces. Avoid unusual body positions.
- ▶ Dress properly. Do not wear loose clothing or jewelry. Keep your hair, clothing and gloves away from moving parts. Loose clothes, jewelry or long hair can be caught in moving parts.
- ▶ If the product or the cutting disc has been dropped or has fallen, check the product and the cutting disc for damage. Change the cutting disc if necessary.
- ▶ Switch the product off before adjusting the guard or changing the cutting disc.
- ▶ Wear protective gloves when changing the cutting disc. Touching the cutting disc presents a risk of injury (cuts or burns).
- ▶ Make sure you have a fire-extinguishing agent available as the possibility of flying sparks while working and the use of flammable fuel presents a risk of fire.
- ▶ Use of reducing sleeves is not permitted.
- ▶ Use of the wet cutting method is preferable in order to reduce the amount of dust produced when cutting mineral materials and asphalt.
- ▶ Avoid skin contact with the sawing slurry created when using the wet cutting method.

- ▶ Dust from material such as paint containing lead, some wood species, minerals and metal may be harmful. Contact with or inhalation of the dust may cause allergic reactions and/or respiratory diseases among operators or bystanders. Material containing asbestos may be worked on only by specialists. To reduce the amount of dust produced when cutting, we recommend use of the wet cutting method. Ensure that the workplace is well ventilated. The use of a dust mask of filter class P2 is recommended. Follow national requirements for the materials you want to work with.
- ▶ Improve the blood circulation in your fingers by relaxing your hands and exercising your fingers during breaks between working. Exposure to vibration during long periods of work can lead to disorders of the blood vessels and nervous system in the fingers, hands and wrists.
- ▶ Consult the responsible structural engineer, architect or person in charge of the building project before beginning the work. Slits cut in load-bearing walls of buildings or other structures may influence the statics of the structure, especially when steel reinforcing bars or load-bearing components are cut through.
- ▶ Apply appropriate safety measures at the opposite side of the workpiece in work that involves breaking through. Pieces of debris could drop out and / or fall down and injure other persons.
- ▶ Never leave the product running while unattended. Switch the engine off and wait until the cutting disc has completely stopped rotating before placing the product on the ground or before transporting it.
- ▶ If the product is operated without an external water pump, it is essential that the pump cover is fitted.
- ▶ Switch the product off after use.
- ▶ Look after the product carefully. Check to ensure that no parts are broken or damaged in such a way that the product may no longer function correctly. If parts are damaged, have the parts replaced before use of the product.
- ▶ To reduce the risk of injury, use only genuine **Hilti** accessories and accessory tools.
- ▶ Have the product repaired only by qualified, skilled personnel, using only genuine Hilti spare parts. The safety of the product can thus be maintained.
- ▶ Observe the national health and safety requirements.

### 2.1.2 Electrical safety

- ▶ Before beginning work, check the working area for concealed electric cables or gas and water pipes. External metal parts of the machine may give you an electric shock if you damage an electric cable accidentally.

### 2.1.3 Safety at the workplace

- ▶ Ensure that the workplace is well lit.
- ▶ Don't work in closed rooms. Carbon monoxide, unburned hydrocarbons and benzene in the exhaust gas may cause asphyxiation.
- ▶ Keep the workplace tidy. Objects which could cause injury should be removed from the working area. Untidiness at the workplace can lead to accidents.
- ▶ Hot exhaust gases containing sparks or sparks generated by the cutting operation may cause fire or explosion. Take care to ensure that the sparks generated do not ignite flammable (gasoline, dry grass, etc.) or explosive (gas, etc.) substances.
- ▶ Before fitting the water pump, check to ensure that the maximum permitted water supply pressure of 6 bar is not exceeded.
- ▶ Fit the filled water tank only after the saw has been mounted on the saw trolley. This will help to prevent the trolley falling over.
- ▶ Do not stand the product and the saw trolley on an inclined surface. Always check to ensure that the product and the saw trolley are standing securely.

### 2.1.4 Liquids (gasoline and oil) and vapors

- ▶ Allow the product to cool before refueling.
- ▶ Never smoke while refueling.
- ▶ Don't refuel the product at the workplace area. When refueling, take care to avoid fuel spillage. Use a suitable funnel.
- ▶ Avoid inhaling gasoline vapors and exhaust fumes. Take care to ensure adequate ventilation.
- ▶ Don't use the gasoline or other flammable liquids for cleaning.

### 2.1.5 Cutting work using cutting discs

- ▶ Use only cutting discs with a rated maximum permissible speed that's at least as high as the highest spindle speed.

- ▶ Check that the outside diameter and the thickness of the cutting disc comply with the capacity rating of the product.
- ▶ Never use cutting discs that are damaged, run untrue or vibrate.
- ▶ Do not use damaged diamond cutting discs (cracks in the steel disc, broken or polished segments, damaged arbor hole, bent or distorted steel disc, heavy discoloration due to overheating, steel disc worn away beneath the segments, diamond segments with no lateral overhang, etc.).
- ▶ Do not use toothed accessory cutting tools (e.g. toothed saw blades).
- ▶ When fitting the cutting disc, always take care to ensure that the disc's specified direction of rotation corresponds to the direction of rotation of the spindle.
- ▶ The cutting disc and flange or any other accessory must fit the arbor of the product exactly. Cutting discs or accessories with arbor holes that do not match the mounting hardware of the product will run out of balance, vibrate excessively and may cause loss of control.
- ▶ Always use an undamaged clamping flange of the correct diameter which fits the cutting disc used. The correctly fitting clamping flange supports the cutting disc and thus reduces the possibility of disc breakage.
- ▶ Guide the product smoothly and do not apply lateral pressure to the cutting disc. Always bring the cutting disc into contact with the workpiece at right angles. Don't attempt to alter the line of cut by applying lateral pressure or by bending the cutting disc while cutting is in progress.
- ▶ Wear protective gloves when changing the cutting disc as the disc will get hot during use.
- ▶ Abrasive cutting discs which are used for wet cutting must be used up the same day as long periods of exposure to moisture have a negative effect on the strength of the disc.
- ▶ Observe the expiry date for resin-bonded cutting discs and don't use the discs after this date.

### 2.1.6 Transport and storage

- ▶ Switch the product off before transporting it.
- ▶ Remove the cutting disc from the product after use. The cutting disc may suffer damage during transport with the disc fitted.
- ▶ Handle the cutting disc carefully and store it in accordance with the manufacturer's instructions.
- ▶ Always store and transport the product in an upright position, not lying on its side.
- ▶ Do not carry the saw trolley and the product together. Remove the water tank before transporting the saw trolley.
- ▶ Do not lift the product and the saw trolley by crane. This is not permissible.
- ▶ Store the product in a secure place when not in use. Products which are not in use must be stored in a dry, high place or locked away out of reach of children.
- ▶ When laying the product down, make sure that it stands securely.
- ▶ After use, allow the product to cool down before packing it away or placing a cover over it.
- ▶ Store gasoline and oil in a well-ventilated room in fuel containers that comply with regulations.

## 3 Description

### 3.1 Overview of the product

#### 3.1.1 Gasoline-powered cut-off saw 1

①	Hood	⑭	Clamping screw
②	Water supply	⑮	Clamping flange
③	Forward grip	⑯	Spark plug connector
④	Water valve	⑰	Decompression valve
⑤	Starter handle	⑱	Throttle safety grip
⑥	Fuel tank cap	⑲	Start/stop switch (DSH 700 OR DSH 900)
⑦	Choke lever / half-throttle lock (DSH 700 OR DSH 900)	⑳	Start/stop switch with integrated half-throttle lock (DSH 700-X OR DSH 900-X)
⑧	Throttle trigger	㉑	Primer bulb
⑨	Rear grip	㉒	Water connection
⑩	Rating plate	㉓	Grip for guard adjustment
⑪	Fuel gauge	㉔	Blade rotation direction (arrow in front part of guard)
⑫	Guide wheels	㉕	Saw arm
⑬	Cutting disc		

⑳ Hole for locking pin for changing cutting discs

㉔ Pump cover

㉕ Air filter cover

### 3.1.2 Saw trolley (accessory) 2

① Grip

② Throttle trigger

③ Cutting depth adjustment

④ Hold-down device

⑤ Water tank

⑥ Water connection

⑦ Axial adjustment

⑧ Throttle cable

⑨ Machine cradle

### 3.2 Intended use

The product described is a gasoline-powered cut-off saw for the wet or dry cutting of asphalt, mineral construction materials or metals using diamond cutting discs or abrasive cutting discs. It can be held and guided by hand or mounted on a saw trolley.

The saw is not suitable for use in environments where there is risk of fire or explosion.

### 3.3 Recommendations for use

#### We recommend:

- Use of the wet cutting method is preferable in order to reduce the amount of dust produced when cutting. By using the self-priming water pump (accessory) you can work without need for a water supply pipe. The water can be drawn, for example, directly from a container.
- Do not cut right through the workpiece in one pass. Move the saw back and forward several times until it gradually reaches the desired cutting depth.
- To avoid damaging the diamond cutting disc when dry cutting, lift the disc out of the cut for approx. 10 seconds every 30 to 60 seconds while the product is still running.
- Resharpen polished diamond segments (no diamonds project from the segment matrix) by cutting with the disc in a very abrasive material such as sandstone.
- For extensive floor sawing applications, mount the saw on the trolley (accessory).

### 3.4 Cutting disc specifications

Diamond cutting discs in accordance with ANSI B7.1 are to be used with the product. Synthetic resin-bonded, fiber-reinforced cutting discs in accordance with ANSI B7.1 (straight, not dish-shaped, type cutting-off wheel) may also be used with the product for working on metals.

The disc mounting instructions and instructions for use issued by the cutting disc manufacturer must be observed.

### 3.5 Items supplied

Gasoline-powered saw, DSH tool set, DSH consumables set (only with the DSH 700-X/900-X), operating instructions.

You can find other system products approved for your product at your local **Hilti** Center or online at: [www.hilti.com](http://www.hilti.com)

### 3.6 Consumables and wearing parts

- Air filter
- Cord (5 pcs)
- Starter
- Fuel filter
- Spark plug
- Tool set
- Cylinder set
- Mounting screw assy.
- Flange (2)
- Centering ring 20 mm / 1"

## 4 Technical data

### 4.1 Gasoline-powered cut-off saw

	<b>DSH 700 / DSH 700-X 30/12"</b>	<b>DSH 700 / DSH 700-X 35/14"</b>	<b>DSH 900 / DSH 900-X 35/14"</b>	<b>DSH 900 / DSH 900-X 40/16"</b>
<b>Cubic capacity</b>	4.19 in <sup>3</sup> (68.7 cm <sup>3</sup> )	4.19 in <sup>3</sup> (68.7 cm <sup>3</sup> )	5.3 in <sup>3</sup> (87 cm <sup>3</sup> )	5.3 in <sup>3</sup> (87 cm <sup>3</sup> )
<b>Weight without cutting disc, tank empty</b>	25.6 lb (11.6 kg)	26.0 lb (11.8 kg)	26.5 lb (12.0 kg)	26.9 lb (12.2 kg)
<b>Weight with saw carriage, without cutting disc, tank empty</b>	93.9 lb (42.6 kg)	94.4 lb (42.8 kg)	94.8 lb (43.0 kg)	95.2 lb (43.2 kg)
<b>Power rating</b>	4.7 hp (3.5 kW)	4.7 hp (3.5 kW)	5.8 hp (4.3 kW)	5.8 hp (4.3 kW)
<b>Maximum arbor speed</b>	5,100 rpm	5,100 rpm	5,100 rpm	4,700 rpm
<b>Maximum cutting depth</b>	3.9 in (100 mm)	4.9 in (125 mm)	4.9 in (125 mm)	5.9 in (150 mm)

### 4.2 Additional technical data

<b>Engine type</b>	Single-cylinder, air-cooled two-stroke engine
<b>Engine speed</b>	9500 ± 200 rpm
<b>No-load speed</b>	2,500 rpm ... 3,000 rpm
<b>Ignition (type)</b>	Electronically-controlled ignition timing
<b>Electrode gap</b>	0.02 in (0.5 mm)
<b>Spark plug</b>	Manufacturer: NGK, type: CMR7A-5
<b>Tightening torque for fitting the spark plug</b>	9 ftlb, (12 Nm)
<b>DSH 700/900 carburetor</b>	Manufacturer: Walbro; model: WT; type: 895
<b>DSH 700/900-X carburetor</b>	Manufacturer: Walbro; model: WT; type: 1152
<b>Fuel mixture</b>	API-TC oil 2% (1:50)
<b>Tank capacity</b>	54.9 in <sup>3</sup> (900 cm <sup>3</sup> )
<b>Cutting disc arbor size / diameter of centering bush</b>	0.8 in (20 mm)
<b>Cutting disc arbor size / diameter of centering bush</b>	1.00 in (25.4 mm)
<b>Minimum flange outside diameter</b>	4.0 in (102 mm)
<b>Max. disc thickness (steel disc thickness)</b>	0.22 in (5.5 mm)
<b>Tightening torque for fitting the cutting disc</b>	18 ftlb, (25 Nm)

## 5 Before use

### 5.1 Fuel

The two-stroke engine runs on a mixture of gasoline and oil. The quality of the fuel mixture decisively influences the running and life expectancy of the engine.



## DANGER

**Risk of fire and explosion.** Gasoline vapors are highly flammable.

- ▶ Never smoke while refueling.
- ▶ Don't refuel the product at the area where you are working (move at least 3 meters (10 feet) away from the working area).
- ▶ Don't refuel the product while the engine is running. Wait until the engine has cooled down.
- ▶ Make sure there are no naked flames or sparks that could ignite the gasoline vapors.
- ▶ Take care to avoid fuel spillage. If fuel is spilled, clean up the areas affected immediately.
- ▶ Check to ensure there is no leakage from the fuel tank.



## CAUTION

**Risk of injury.** The inhalation of gasoline vapors and skin contact with gasoline may be hazardous to the health.

- ▶ Avoid direct skin contact with gasoline. Wear protective gloves.
- ▶ If your clothing becomes soiled with gasoline, it is essential to change your clothing.
- ▶ Ensure that the workplace is well ventilated in order to avoid breathing in gasoline fumes.
- ▶ Use a fuel container that complies with the applicable regulations.



## Note

Alkylate gasoline does not have the same density (specific weight) as conventional gasoline. To avoid damage when alkylate gasoline is used, the engine settings must be readjusted by **Hilti** Service. Alternatively, the oil content can be increased to 4% (1:25).

### 5.1.1 Using two-stroke oil

- ▶ Use good-quality, two-stroke oil for air-cooled engines that meets at least the API-TC specification.

### 5.1.2 Gasoline

- ▶ Use regular or super gasoline with an octane rating of at least 89 ROZ.



## Note

The alcohol content (e.g. ethanol, methanol or others) of the fuel used must not exceed 10%, otherwise the life expectancy of the engine will be greatly reduced.

### 5.1.3 Mixing fuel



## Note

The engine will suffer damage if run with fuel mixed in the wrong ratio or with unsuitable oil.

Use a mixing ratio of 1:50. This corresponds to 1 part good-quality two-stroke oil that complies with the API-TC specification and 50 parts gasoline (e.g. 100 ml oil and 5 liters of gasoline mixed in a suitable canister).

1. Pour the required quantity of two-stroke oil into the fuel canister.
2. Then fill the gasoline into the fuel canister.
3. Close the fuel canister.
4. Mix the fuel by shaking the fuel container.



## Note

If the quality of the two-stroke oil or the gasoline is unknown, then increase the mixing ratio to 1:25.

### 5.1.4 Filling the fuel tank

1. Mix the fuel (two-stroke oil / gasoline mixture) by shaking the fuel container.
2. Place the product in a steady upright position.
3. Open the fuel tank by turning the cap counterclockwise and then removing the cap.
4. Fill the tank slowly using a funnel.
5. Close the fuel tank by fitting the cap and then turning it clockwise.
6. Close the fuel canister.

## 5.2 Assembly and adjustment



### WARNING

**Risk of injury.** Contact with the rotating cutting disc can lead to injury. Hot parts of the machine or a hot cutting disc may cause burning injuries.

- ▶ Before fitting or adjusting any parts of the product, make sure that the engine is switched off, that the cutting disc has completely stopped rotating and that the product has cooled down.
- ▶ Wear protective gloves.

### 5.2.1 Fitting a cutting disc



### CAUTION

**Risk of injury and damage.** Damaged cutting discs may break.

- ▶ Never use cutting discs that are damaged, run untrue or vibrate.
- ▶ Don't use synthetic resin-bonded fiber-reinforced cutting discs which have exceeded their use-by date or already softened due to water absorption.



### CAUTION

**Risk of injury and damage.** Cutting discs or fastening parts that don't fit correctly can suffer irreparable damage or lead to loss of control of the product.

- ▶ Use only cutting discs with a rated maximum permissible speed that's at least as high as the maximum speed stated on the product. The cutting discs, flanges and screws used must fit the product.
- ▶ Use only cutting discs with an arbor size (mounting hole diameter) of 20 mm or 25.4 mm (1").

1. Insert the locking pin in the hole in the drive belt cover and turn the cutting disc until the locking pin engages.
2. Release the securing screw by turning the screw counterclockwise with the wrench and then remove the screw and washer.
3. Remove the locking pin.
4. Remove the clamping flange and the cutting disc.
5. Check that the mounting bore of the cutting disc to be fitted corresponds with the centering collar of the cutting disc mounting flange.



### Note

The mounting flange is equipped with a 20 mm diameter centering collar on one side and a 25.4 mm (1") diameter centering collar on the opposite side.

6. Clean the clamping and centering surfaces on the product and on the cutting disc.
7. Place the cutting disc with centering collar on the drive arbor and check that the direction of rotation is correct.
  - ◀ The direction-of-rotation arrow on the cutting disc must match the direction of rotation indicated on the product.
8. Place the clamping flange and washer on the drive arbor and tighten the securing screw by turning it clockwise.
9. Insert the locking pin in the locking hole in the drive belt cover and turn the cutting disc until the locking pin engages.
10. Tighten the clamping screw securely (tightening torque: 25 Nm).
11. Remove the locking pin.



### Note

After fitting a new cutting disc allow the product to run at full speed under no load for approx. 1 minute.



## 5.2.2 Adjusting the guard



### DANGER

**Risk of injury.** Flying fragments or sparks could cause injury.

- ▶ Adjust the guard so that flying particles or fragments of the material removed and flying sparks are directed away from the operator and the product.
- ▶ Hold the guard by the grip provided and rotate it to the desired position.

## 5.2.3 Conversion from normal cutting to flush cutting



### Note

The front section of the saw arm can be converted to allow flush cuts to be made (e.g. as close as possible to edges and walls).

- ▶ If you wish to use the product in the flush cutting position, have the product converted by **Hilti Service**.

## 5.3 Locking rotary movement of the guide wheels



### WARNING

**Risk of injury.** The saw could move inadvertently or fall down.

- ▶ When working on roofs, scaffolds and/or on slightly sloping ground or surfaces, always take steps to prevent rotation of the guide wheels when the saw is not in use.

1. Release the guide wheel mounting screws and remove the guide wheels.
2. Reverse the guide wheels (turn through 180°) and refit the mounting screws.
  - ◀ The integrated locking function is active.
3. Check that the guide wheels are securely fastened.

## 5.4 Mounting the gasoline-powered saw on the saw trolley (accessory)

1. Remove the water tank from the saw trolley.
2. Move the cutting depth adjustment lever into the upper position.
3. Open the hold-down device by releasing the screw knob.
4. Fit the saw into the forward mount with the wheels as shown and swing the grip of the saw under the hold-down device.
5. Secure the saw by tightening the screw knob.
6. Fit the water tank after filling it.
7. Adjust the grip to a convenient working height.
8. Adjust the guard to the correct position. → page 10



### Note

Especially when using the machine in this configuration for the first time, check to ensure that the throttle cable is correctly adjusted. When the throttle trigger is pressed fully, the product must run up to maximum speed. If this is not the case, the throttle cable can be readjusted by way of the cable tensioner.

When the throttle is not actuated, the engine must be idling and the cutting disc must not rotate. If this is not the case, switch off by pushing the start/stop switch to the “stop” position and then adjust the throttle cable or have the idling speed adjusted by **Hilti Service**.

## 5.5 Fitting the water pump (accessory)

1. Release the three pump cover retaining screws, remove the parts and store the pump cover in a safe place.



### Note

The pump cover must be fitted if the product is used without the water pump.

2. Bring the water pump into place while rotating the cutting disc slightly until the toothing on the water pump and inside the clutch housing match and the teeth mesh correctly.
  - ◀ The position is keyed so it is not possible to position the pump incorrectly.
3. Fit the three retaining screws and tighten them securely (tightening torque: 4 Nm).

4. Connect the pump hose to the hose connector on the saw.
5. Connect the water pump to the water supply or hang the suction hose in a container filled with water.

**Note**

The maximum permitted water supply pressure is 6 bar.

## 5.6 Removing the water pump (accessory)

1. Disconnect the water supply from the water pump.
2. Disconnect the connector between the pump and the product.
3. Release the three fastening screws on the pump and then remove the pump.
4. Fit the pump cover on the product, insert the three retaining screws and tighten the screws securely (tightening torque: 4 Nm).

## 6 Operation

### 6.1 Starting the engine

**DANGER**

**Risk of asphyxiation.** Carbon monoxide, unburned hydrocarbons and benzene in the exhaust gas may cause asphyxiation.

- ▶ Don't work in closed rooms, trenches or pits and make sure the area is well ventilated.

**WARNING**

**Risk of burning injury.** The exhaust system gets extremely hot when the engine is running. It stays hot for a long time after the engine is switched off.

- ▶ Wear protective gloves and avoid touching the exhaust system.
- ▶ Do not lay the product down on flammable material while hot.

**WARNING**

**Risk of injury.** A damaged exhaust system will raise the noise level above the permissible limit and thus cause hearing damage.

- ▶ Never use the product if the exhaust system is damaged, missing or if it has been tampered with.

#### 6.1.1 Starting the engine

DSH 700  
DSH 900

1. Press the decompression valve (once).
2. Squeeze the primer bulb 2 to 3 times until the primer bulb is completely filled with fuel.
3. Move the start/stop switch to the "start" position.
4. Select one of the following alternatives. This action includes 2 alternatives.  
**Alternative 1 / 2**
  - ▶ If the motor is cold, pull the choke lever upwards.
    - ◀ The choke and half throttle are engaged.
  - Alternative 2 / 2**
    - ▶ If the motor is hot, pull the choke lever up and then push it back down.
      - ◀ Half throttle is engaged, the choke is not engaged.
5. Check that the cutting disc is free to rotate.
6. Position your right foot over the lower part of the rear grip.
7. Pull the starter handle slowly with your right hand until resistance is felt.
8. Pull the starter handle vigorously.
9. When the motor fires for the first time (after 2 to 5 pulls of the starter), move the choke lever back down to its original position.
10. Pull the starter handle vigorously and repeat this action until the engine starts.



#### Note

The motor will flood if the starting procedure is repeated too many times with the choke engaged.

1. Press the throttle trigger briefly as soon as the engine starts.
  - ◁ This disengages the half-throttle position and the engine then runs at idling speed when the throttle is released.

### 6.1.2 Starting the engine

DSH 700-X  
DSH 900-X

1. Press the decompression valve (once).
2. When starting the cold engine (only when cold), squeeze the primer bulb 2 to 3 times (until the primer bulb is completely filled with fuel).
3. Press the throttle safety grip and keep it pressed.
4. Press the throttle trigger and keep it pressed.
5. Move the start/stop switch to the “start” position.
6. Release the throttle safety grip and throttle trigger.
  - ◁ This half-throttle position is activated.
7. Check that the cutting disc is free to rotate.
8. Position your right foot over the lower part of the rear grip.
9. Pull the starter handle slowly with your right hand until resistance is felt.
10. Pull the starter handle vigorously.
11. Repeat this action until the engine starts.
12. Press the throttle trigger briefly as soon as the engine starts.
  - ◁ This disengages the half-throttle position and the engine then runs at idling speed when the throttle is released.

### 6.2 Checks after starting the engine

1. Check that the cutting disc remains stationary when the engine is idling and, after briefly running at full speed, that the disc again comes to a complete standstill.
  - ◁ Readjust (reduce) the idling speed if the cutting disc doesn't stop rotating when the engine is idling. If this is not possible, please bring the product to **Hilti Service**.
2. Check that the start/stop switch is functioning correctly. Move the start/stop switch to the “stop” position.

DSH 700  
DSH 900

- ▶ If the engine doesn't stop, push the choke lever upwards. If the engine still doesn't stop, pull the spark plug connector off the spark plug and bring the product to **Hilti Service**.

DSH 700-X  
DSH 900-X

- ▶ If the engine doesn't stop, compress the primer bulb. If the engine still doesn't stop, pull the spark plug connector off the spark plug and bring the product to **Hilti Service**.

### 6.3 Switching the engine off



#### WARNING

**Risk of injury.** A rotating cutting disc can break or shatter, possibly resulting in flying fragments.

- ▶ Allow the rotating cutting disc to come to a complete standstill before you lay the saw down.

1. Release the throttle trigger.
2. Move the start/stop switch to the “stop” position.
  - ◁ The engine stops.

### 6.4 Cutting techniques

**In order to work optimally with this product, the following safety instructions must be observed:**

- Always hold the product and the saw trolley with both hands on the grips provided. Keep the grips dry, clean and free from oil and grease.

- Before beginning the work, or if an obstacle was previously inadvertently contacted, check the cutting disc and guard immediately for possible damage.
- Check that no persons are present in the working area and, in particular, in the direction in which the cut is to be made. Keep other persons approx. 15 m away from your workplace.
- Guide the product smoothly and do not apply lateral pressure to the cutting disc.
- Always bring the cutting disc into contact with the workpiece at right angles. Don't attempt to alter the line of cut by applying lateral pressure or by bending the cutting disc while cutting is in progress.
- Secure the workpiece. Use clamps or a vice to hold the workpiece in position. The workpiece is thus held more securely than by hand and both hands remain free to operate the product.
- Secure the workpiece and the part to be cut off in order to prevent uncontrolled movement.
- ▶ When working with the saw trolley, check before use that the gasoline-powered saw is mounted correctly on the saw trolley.
- ▶ Switch the gasoline-powered saw off immediately at the start/stop switch in the event of the saw trolley throttle cable sticking or if the throttle trigger sticks.
- ▶ Always apply full throttle when cutting.

#### 6.4.1 Avoiding stalling



##### **CAUTION**

**Risk of disc breakage or kickback.** Application of excessive pressure causes distortion of the cutting disc. Sticking or stalling of the cutting disc increases the probability of kickback or disc breakage.

- ▶ Avoid applying excessive pressure when cutting and don't allow the cutting disc to stick and stall.
- ▶ Don't attempt to make an excessively deep cut.

1. Cutting through thick workpieces should be accomplished, as far as possible, by making a several cuts. Avoid making excessively deep cuts.
2. Support slabs or large workpieces so that the kerf remains open during and after the cutting operation.

#### 6.4.2 Avoiding kickback

1. Always bring the cutting disc into contact with the workpiece from above.
  - ◀ Allow the cutting disc to contact the workpiece only at a point below its rotational axis.
2. Take special care when inserting the cutting disc in an existing kerf.

## 7 Care and maintenance



##### **WARNING**

**Risk of injury.** Touching the rotating cutting disc or hot parts of the machine may lead to injury or burns.

- ▶ Switch the engine off and allow the product to cool down before all maintenance, repairs, cleaning or servicing.

### 7.1 Maintenance

#### 7.1.1 Before use

1. Check that the product is complete, not leaking and that it is in faultless condition. Repair it if necessary.
2. Check that the product is not dirty and clean it if necessary.
3. Check that the operating controls function correctly. Have them repaired if necessary.
4. Check that the cutting disc is in faultless condition and replace it if necessary.
5. Check the tightness of all externally accessible screws and nuts and retighten them if necessary.

#### 7.1.2 Every 6 months

1. Check the tightness of all externally accessible screws and nuts and retighten them if necessary.
2. Check the fuel filter for dirt or clogging and replace it if necessary.

#### 7.1.3 If necessary

1. Check the tightness of all externally accessible screws and nuts and retighten them if necessary.
2. Change the air filter if the engine fails to start or if its performance drops noticeably.
3. Check fuel filter for dirt or clogging and replace it if necessary.

4. Clean the spark plug, or replace it if necessary, if the product doesn't start or starts only with difficulty.
5. Readjust (reduce) the idling speed if the cutting disc doesn't stop rotating when the engine is idling.
6. Have the product repaired by **Hilti Service** if the drive belt slips when a load is applied to the cutting disc.

## 7.2 Cleaning or replacing the air filter **11**

**Risk of damage.** Entry of dust causes irreparable damage to the product.

- ▶ Never operate the machine if the air filter is damaged or missing.
- ▶ When changing the air filter, the product should stand upright and should not be laid on its side. Take care to ensure that no dust finds its way onto the underlying filter screen.



### Note

Change the air filter if engine performance drops noticeably or if the engine becomes difficult to start.

1. Release the securing screw on the air filter cover and remove the cover.
2. Carefully remove the dust adhering to the air filter and the filter chamber (use a vacuum cleaner).
3. Release the four screws retaining the filter holder and remove the air filter.
4. Fit the new filter and secure it with the filter holder.
5. Fit the air filter cover and tighten the retaining screws.

## 7.3 Replacing a broken starter cord **12**



### CAUTION

**Risk of damage.** The housing may suffer damage if the starter cord is too short.

- ▶ Never continue to use a broken starter cord. Replace it immediately.

1. Unscrew the three securing screws and remove the starter assembly.
2. Remove the remaining pieces of the starter cord from the spool and the starter handle.
3. Make a secure knot in the end of the replacement starter cord and then pass the free end of the cord through the hole in the spool from above.
4. Pass the end of the cord through the opening in the starter housing from below, also through the starter handle from below, and then make a secure knot in the end of the cord.
5. Pull a length of the starter cord out of the housing as shown in the illustration and pass it through the slot in the spool.
6. Hold the cord securely close to the slot in the spool and then rotate the spool in a clockwise direction as far as it will go.
7. Rotate the spool back from its end point at least a ½ revolution, max. 1 ½ revolutions, until the slot in the spool is in alignment with the opening in the starter housing.
8. Hold the spool securely and pull the free end of the cord out of the housing towards the starter handle.
9. Hold the cord under tension, release the spool and allow the starter cord to be pulled in.
10. Pull the starter cord out as far as it will go and check to ensure that the spool can be turned by hand at least a further ½ turn in a clockwise direction. If this is not possible, spring tension must be reduced by one revolution in a counterclockwise direction.
11. Fit the starter assembly and press it down gently. Pull the starter cord slightly until the coupling engages and the starter assembly is fully seated.
12. Secure the starter assembly with the three retaining screws.

## 7.4 Replacing the fuel filter **13**



### Note

When refueling the product, take care to ensure that no dirt or foreign matter finds its way into the fuel tank.

1. Remove the cap from the fuel tank.
2. Pull the fuel filter out of the fuel tank.
3. Check the condition of the fuel filter.
  - ◀ Replace the fuel filter if it is very dirty or clogged.
4. Slide back the clip on the hose and remove the dirty fuel filter.

5. Fit a new fuel filter and secure it with the clip on the hose.
6. Push the fuel filter back into the fuel tank.
7. Close the fuel tank.

## 7.5 Cleaning the spark plug, setting the spark plug gap or replacing the spark plug 14



### CAUTION

**Risk of injury.** The spark plug and parts of the engine may be hot immediately after the product has been in use.

- ▶ Wear protective gloves and allow the product to cool down.

1. Use a gentle twisting motion to pull the cable connector off the spark plug.
2. Use the spark plug wrench to unscrew and remove the spark plug from the cylinder.
3. If necessary, clean the spark plug electrode with a soft wire brush.
4. Check the spark plug gap with the aid of a feeler gauge and, if necessary, reset it to the correct gap (0.5 mm).
5. Fit the ignition cable connector to the spark plug and hold the threaded section of the spark plug against the cylinder.
6. Move the start/stop switch to the "start" position.



### WARNING

**Risk of injury.** Touching the electrodes presents a risk of electric shock.

- ▶ Don't touch the spark plug electrodes.

7. Pull the starter cord (press the decompression valve first).
  - ◀ An ignition spark must now be clearly visible.
8. Use the spark plug wrench to screw the spark plug into the cylinder (tightening torque: 12 Nm).
9. Fit the ignition cable connector to the spark plug.

## 7.6 Adjusting the carburetor 15

The carburetor of this product has been factory set for optimum performance and sealed to prevent tampering (jets H and L). The idling speed of the machine (jet T) may be adjusted by the user. All other adjustments must be carried out by **Hilti** Service.



### Note

Tampering with the carburetor settings may cause damage to the engine.

- ▶ Clean the air filter. → page 14
- ▶ Allow the product to run until it reaches its normal operating temperature.
- ▶ Use a suitable flat screwdriver (tip width 4 mm/  $\frac{5}{32}$  ") and do not force the adjusting screw beyond its intended adjustment range.
- ▶ Adjust the idling speed jet (T) so that the engine runs smoothly when idling but the cutting disc does not begin to rotate.

## 7.7 Care and maintenance of the machine



### Note

To help ensure safe and reliable operation, use only genuine Hilti spare parts and consumables. Spare parts, consumables and accessories approved by us for use with the product can be found at your local **Hilti** Center or online at: [www.hilti.com](http://www.hilti.com)

- ▶ Keep the product, especially its grip surfaces, clean and free from oil and grease.
- ▶ Do not use cleaning agents containing silicone.
- ▶ Clean the outer surfaces of the machine at regular intervals with a slightly damp cloth or a dry brush. Do not use a spray, steam pressure cleaning equipment or running water for cleaning.
- ▶ Do not allow foreign objects to enter the interior of the product.

## 7.8 Maintenance

1. Check all external parts of the product and the accessories for damage at regular intervals and check that all controls operate faultlessly.
2. Do not use the product if parts are damaged or if operating controls do not function faultlessly. Have the product repaired by **Hilti Service**.

## 7.9 Checks after care and maintenance work

- ▶ After carrying out care and maintenance, check that all protective and safety devices are fitted and that they function faultlessly.

## 8 Transport and storage

### 8.1 Transportation in a vehicle



#### **DANGER**

**Risk of fire and explosion.** If the product tips over during transport, fuel may run out of the fuel tank.

- ▶ Empty the product's fuel tank completely before packing and shipping it.
- ▶ Transport the product, as far as possible, in its original packaging.



#### **WARNING**

**Fire hazard.** Hot parts of the machine could ignite material lying about in the surrounding area.

- ▶ Allow the product to cool down completely before packing it away or loading it into a vehicle..

1. Remove the cutting disc.
2. Secure the product to prevent it falling over, thereby causing damage or fuel spillage.
3. Transport the saw trolley only when the water tank has been emptied.

### 8.2 Storing the fuel mixture



#### **CAUTION**

**Risk of injury.** As pressure may build up in the fuel tank there is a risk of fuel being forced out when the fuel cap is opened.

- ▶ Accordingly, take care when opening the cap on the fuel tank.
- ▶ Store the fuel in a dry, well-ventilated room.

1. Mix only enough fuel for a few days' use.
2. Clean the fuel container occasionally.

## 9 Troubleshooting

If the trouble you are experiencing isn't listed in this table or you are unable to remedy the problem by yourself, please contact **Hilti Service**.

Trouble or fault	Possible cause	Action to be taken
Cutting disc slows down or stops completely while cutting	Excessive cutting pressure applied (cutting disc sticks and stalls in the kerf).	▶ Reduce pressure when cutting and guide the product in a straight line.
	The cutting disc is not correctly fitted and tightened.	▶ Check how it is fitted and the tightening torque.
	Wrong direction of rotation.	▶ Fit the cutting disc. → page 9
	The forward section of the saw arm is loose.	▶ Have the product repaired by <b>Hilti Service</b> .
High vibration, disc wanders off the cutting line.	The cutting disc is not correctly fitted and tightened.	▶ Check how it is fitted and the tightening torque.

<b>Trouble or fault</b>	<b>Possible cause</b>	<b>Action to be taken</b>
High vibration, disc wanders off the cutting line.	Cutting disc is damaged (or unsuitable specification, cracked, segments missing, bent, overheated, deformed, etc.).	▶ Change the cutting disc.
	The centering bushing is fitted incorrectly.	▶ Check that the mounting bore of the cutting disc to be fitted corresponds with the centering collar of the cutting disc mounting flange.
The saw doesn't start or is difficult to start.	The fuel tank is empty (no fuel in the carburetor).	▶ Fill the fuel tank. → page 8
	Air filter clogged with dirt or dust.	▶ Change the air filter.
	DSH 700 DSH 900  The engine is flooded (spark plug wet).	▶ Remove the spark plug, dry the plug and allow the cylinder to dry out. ▶ Disengage the choke lever and repeat the starting procedure several times.
	DSH 700-X DSH 900-X  The engine is flooded (spark plug wet).	▶ Remove the spark plug, dry the plug and allow the cylinder to dry out.
	Wrong fuel mixture.	▶ Empty the fuel tank and flush out the tank and fuel supply line. ▶ Fill the fuel tank with the correct fuel.
	Air in the fuel line (no fuel reaching the carburetor).	▶ Remove the air from the fuel line by operating the fuel pump several times.
	The fuel filter is dirty or blocked (no fuel or too little fuel reaching the carburetor).	▶ Clean the fuel tank and change the fuel filter.
	No ignition spark visible or spark is too weak (seen when spark plug is removed).	▶ Clean the spark plug to remove carbon deposits. ▶ Check the spark plug electrode gap and set it correctly. ▶ Change the spark plug. ▶ Check the ignition coil, cable, plug connections and switch and change the defective part if necessary.
	Engine compression is too low.	▶ Check the engine compression and, if necessary, replace worn parts (piston rings, piston, cylinder, etc.).
	The ambient temperature is too low.	▶ Allow the saw to warm up to room temperature and repeat the starting procedure.
Low engine power / poor cutting performance	The spark arrestor or exhaust exit is clogged.	▶ Clean the spark arrestor or exhaust exit.
	The decompression valve is stiff to operate.	▶ Make sure that the valve operates freely.
	Air filter clogged with dirt or dust.	▶ Change the air filter.



Trouble or fault	Possible cause	Action to be taken
Low engine power / poor cutting performance	No ignition spark visible or spark is too weak (seen when spark plug is removed).	<ul style="list-style-type: none"> <li>▶ Clean the spark plug to remove carbon deposits.</li> <li>▶ Check the spark plug electrode gap and set it correctly.</li> <li>▶ Change the spark plug.</li> <li>▶ Check the ignition coil, cable, plug connections and switch and change the defective part if necessary.</li> </ul>
	Wrong fuel mixture.	<ul style="list-style-type: none"> <li>▶ Empty the fuel tank and flush out the tank and fuel supply line.</li> <li>▶ Fill the fuel tank with the correct fuel.</li> </ul>
	The disc specification is unsuitable for the material to be cut.	▶ Change the cutting disc or ask <b>Hilti Service</b> for advice.
	Drive belt or cutting disc slips.	<ul style="list-style-type: none"> <li>▶ Check that the cutting disc is clamped securely.</li> <li>▶ Have the product repaired by <b>Hilti Service</b>.</li> </ul>
	Engine compression is too low.	▶ Check the engine compression and, if necessary, replace worn parts (piston rings, piston, cylinder, etc.).
	The product is used at an altitude greater than 1500 meters above sea level.	▶ Have the carburetor adjusted by <b>Hilti Service</b> .
	Incorrect carburetor setting (fuel / air mixture).	▶ Have the carburetor adjusted by <b>Hilti Service</b> .
Cutting disc rotates while the engine is idling.	Idling speed is too high.	▶ Check the idling speed and adjust it if necessary.
	The half-throttle position is engaged.	▶ Release the half-throttle position.
	Faulty centrifugal clutch.	▶ Change the centrifugal clutch.
Cutting disc doesn't rotate.	Inadequate drive belt tension or the drive belt is broken.	▶ Have the product repaired by <b>Hilti Service</b> .
Starter assembly doesn't work.	The clutch claws are not engaging.	▶ Clean the clutch claws so that they move freely.

## 10 Disposal

 Most of the materials from which **Hilti** products are manufactured can be recycled. The materials must be correctly separated before they can be recycled. In many countries, your old tools, machines or appliances can be returned to **Hilti** for recycling. Ask **Hilti Service** or your Hilti representative for further information.

### Drilling slurry

Disposal of drilling slurry directly into rivers, lakes or the sewerage system without suitable pretreatment presents environmental problems.

- ▶ Ask the local public authorities for information about current regulations.

We recommend the following pretreatment:

- ▶ Collect the drilling slurry (for example, using a wet-type vacuum cleaner).
- ▶ Allow the drilling slurry to settle and dispose of the solid material at a construction waste disposal site (addition of a flocculent may accelerate the settling process).
- ▶ The remaining water (alkaline, pH value greater than 7) must be neutralized by the addition of an acidic neutralizing agent or diluted with a large volume of water before it is allowed to flow into the sewerage system.

## 11 Manufacturer's warranty

- ▶ Please contact your local **Hilti** representative if you have questions about the warranty conditions.



Hilti Corporation

LI-9494 Schaan

Tel.: +423/234 21 11

Fax: +423/234 29 65

[www.hilti.com](http://www.hilti.com)



2122989