

# Assembly Instructions

**Caution :You must read this before you proceed**

## Club Chair

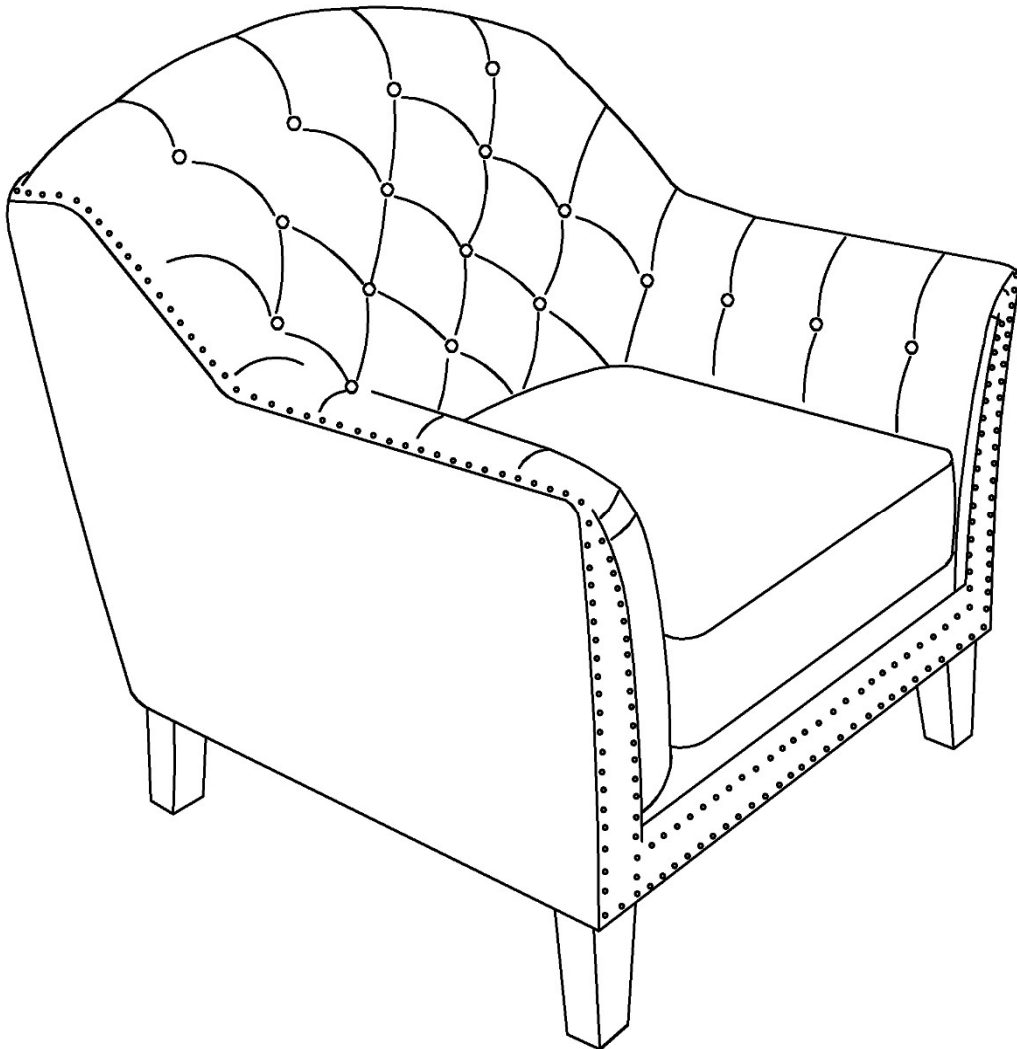

# Parts List

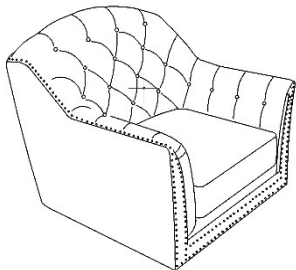
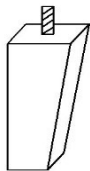
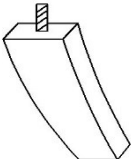
Label	Picture	Description	QTY
A		Chair	1
B		Front Leg	2
C		Hind Leg	2

# Hardware

Label	Picture	Description	QTY
①		Washer Rings	7

# Assembly Preparation

Before Beginning Assembly:

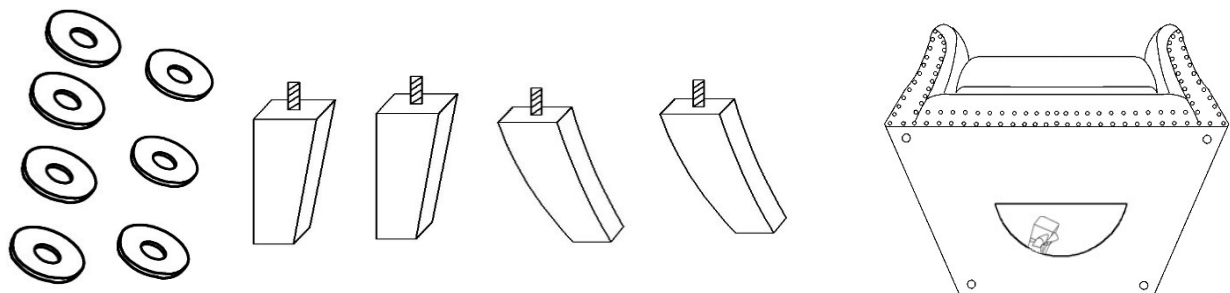

- Read instructions, cover to cover-



- Have 2 adults on hand for assembly-



- Do not assemble on flooring or carpet-



- Assemble on a clean non-marring surface (packing foam)-



- Save all packaging until finished-

# Assembly Steps

## Parts Introduction

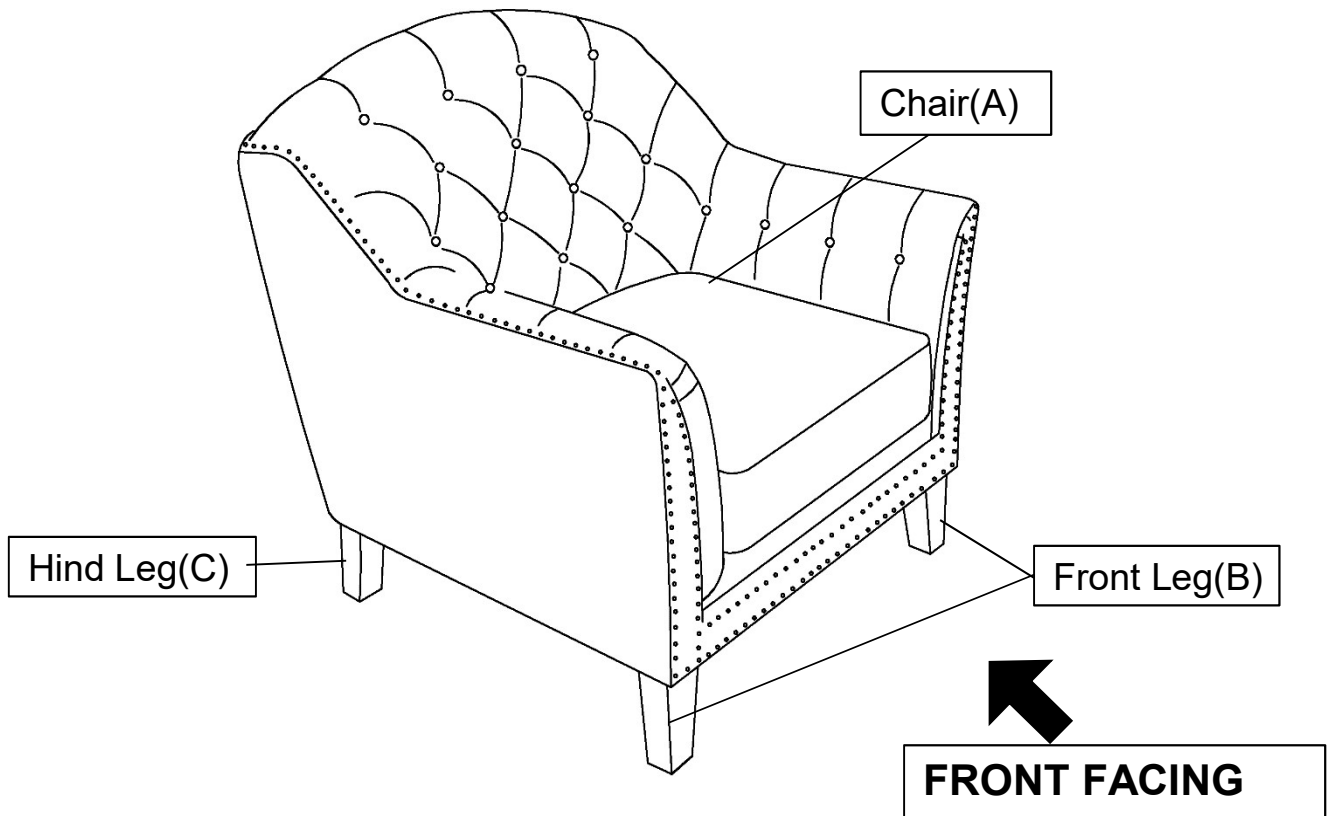

This Club Chair has multiple parts and may require up to some 30 minutes to assemble.

To give you an overview of the Club Chair parts, the above picture is to help you put the various parts into perspective.

Please read through the instructions herebelow to familiarise the parts and steps before assembly.

### Step 1

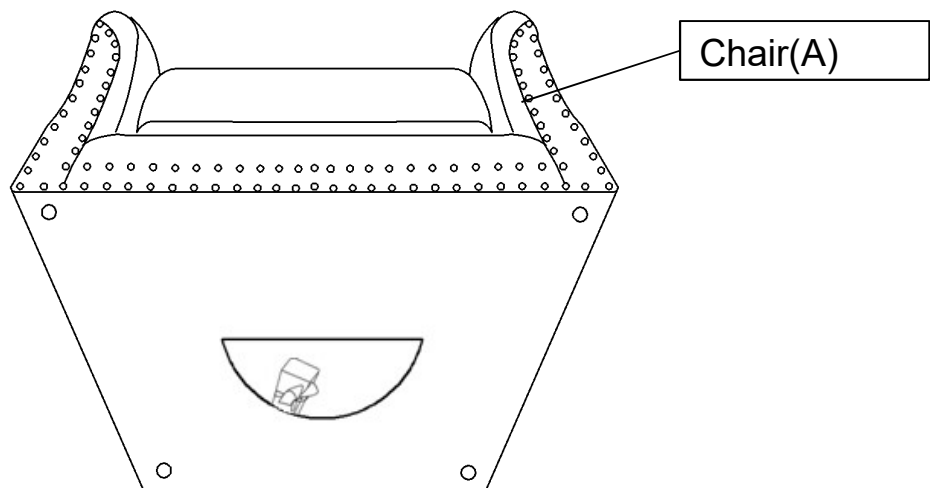

Position the Chair on its back, as shown.

Unzip to open pouch and remove the 4 wooden legs, close the pouch.

**CAUTION: The Chair is large and heavy, always have a second adult to assist you when moving and lifting it.**

## Step 2

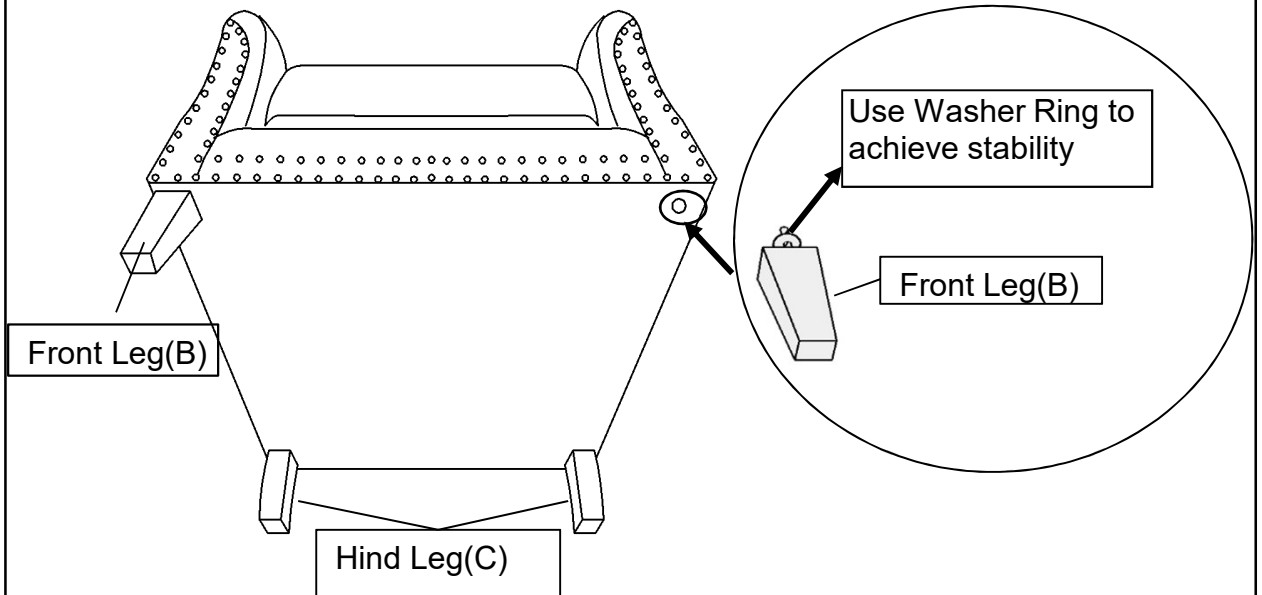

Install the first Front Leg(B) into the bottom of the Chair(A) by placing one Washer Ring(①) onto the threaded stem.

Insert the threaded stem of Front Leg(B) into the front mounting position of Chair(A) then tighten by turning the leg clockwise until the leg is completely secure.

Repeat this process with the remaining three legs.

**Note: The use of the Washer Rings are OPTIONAL and are especially useful to help alleviate slight wobbleness.**

**Some legs may need more than one whilst some legs may not need any.**

### Step 3

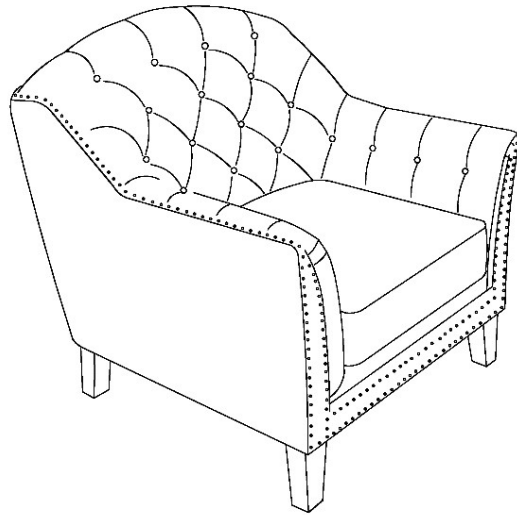











Make sure all parts are connected and locked into position.

Your chair is ready for use.

**Caution: This Chair can only be used on a flat, level surface.**

## Care & Maintenance

-  ● Do not put hot items directly on furniture surface
-  ● Do not clean furniture with harsh cleansers or polish.
-  ● Do not place furniture under direct sunlight.
-  ● Do not place furniture near heating or cooling vents.
-  ● Do not write on furniture without a padded barrier to protect the surface.
-  ● Do not place furniture outside . For indoor use only .
-  ● Not for commercial use. For residential use only .
-  ● Stains may be removed with mild soap solution and damp cloth.
-  ● Children should not climb or jump on the furniture.

- 
-  ● Dust and pick-up spills using a clean, non-colored, lint-free cloth .