



**Wire Connectors**



For complete sales office contact information, visit us at:  
**[www.idealind.com](http://www.idealind.com)**

**IDEAL INDUSTRIES, INC.**  
1375 Park Avenue, Sycamore, IL 60178, USA / 815-895-5181 • 800-435-0705 in USA

**International offices:** Australia • Brazil • Canada • China • Germany • Mexico • UK  
For complete sales office contact information, visit us at:

7/15  
Form No. P-2873  
Printed in USA  
©2015 IDEAL INDUSTRIES, INC.



**Wire Connectors**

**BUILT FOR COMFORT.  
DESIGNED FOR PERFORMANCE.**



**Wire Connector Brochure**

**The Brand Electricians Trust.™**

IDEAL Wire Connectors  
are available in:



**Box:** For small jobs at hand, just grab a box.



**Store 'N Pour™ Jar:**  
Easy-pour design keeps connectors clean  
and your shelf organized.



**Power Pouch™:** The new IDEAL  
Power Pouch™ connector bags are  
convenient, re-closeable and stand  
up on the job.



**Barrel:** For really big jobs  
when you can't afford to run  
out of connectors.

## CONTENTS:

### IDEAL and Buchanan Wire Connectors

Twister® PRO	2
Twister®	3
Twister® LT	3
Wing-Nut®	4
Wire-Nut®	5
B-CAP®	6
B-Twist™	7
WingTwist™	8
WireTwist™	9
WeatherProof™	10
UnderGround™	11
MudBug®	11
Twister® Al/Cu	12
PowerPlug®	13
SpiceLine®	14
In-Sure™ Push-In	15
Grounding	16
Application Guide	17
Ordering Guide	18-19
Wire Range Chart	20

You're a pro. You know to wire the job right you need the best wire connectors available. That's why day in and day out, you choose:

## IDEAL. THE BRAND ELECTRICIANS TRUST.

IDEAL has a connector that's right for every job. Our complete line is built to provide safe, dependable solutions for every application.

Just pick the connector that's right for your job and right for you. You're the pro. You know what works best. IDEAL and Buchanan Wire Connectors. Built for performance and reliability.

For additional details on the entire line of IDEAL Wire Connectors or to request a full-line catalog, visit [www.idealind.com](http://www.idealind.com)



  
**Wire Connectors**



**COMFORT**  
from the IDEAL family of  
Performance & Reliability

# For ultimate COMFORT and maximum wire range

When you've got a job where you'll be making connections all day, the Twister® PRO red/yellow wire connector is the one you want. The SureGrip™ design makes for improved torque while the comfortable swept wings ease hand fatigue. You'll feel the difference immediately.



Patented SureGrip™ overmolding provides improved leverage and more torque

Better grip and more leverage for faster connections

Exceptional wire range and capacity; up to MAX. 4 #10



**Twister® PRO**

**FAST FACT:**

The Twister® PRO is a high performance connector with the industry's widest wire range of any red/yellow connector.

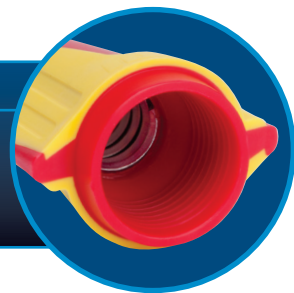

MIN. 2 #18  
MAX. 4 #10



Cu/Cu Only



**COMFORT**  
**Twister® PRO**  
WIRE CONNECTORS

Twister® PRO Wire Connector:



600 Volts Max.\*

\*1,000 Volts signs and fixtures



# More COMFORT, less fatigue

The Twister® Wire Connector easily handles the most common wiring configurations for residential construction projects. A patented, expanding square-wire spring ensures a quick, secure connection.



Hex-top allows for 5/16" nut driver application

Durable copolymer shell expands for progressive tightening, a feature that ensures dependable connections

Quick take-up on even the toughest combinations including solid-to-stranded

Swept-wing design for improved comfort and extra leverage

## Twister®

### FAST FACT:

The small profile of the Twister® LT makes it perfect for recessed lighting applications.

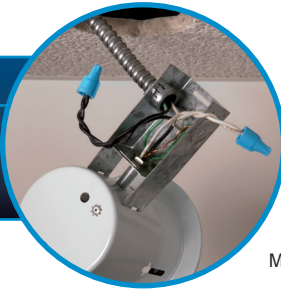

MIN. 3 #14  
MAX. 2 #8 w/ 2 #12

MIN. 3 #22  
MAX. 3 #10

MIN. 2 #22  
MAX. 3 #12

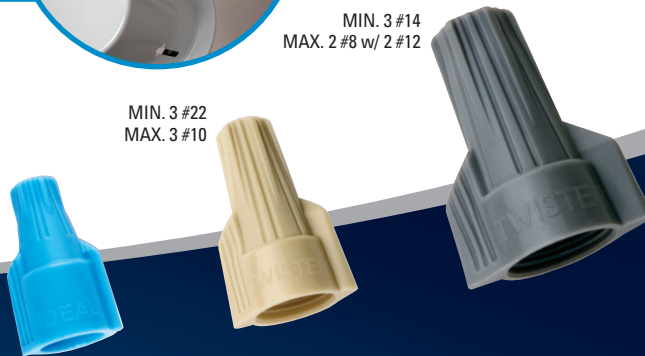

### Twister® Wire Connector:

600 Volts Max.\*

340° Light Blue	MIN. 2 #22				MAX. 3 #12	
341° Tan		MIN. 3 #22				MAX. 3 #10
342° Gray			MIN. 3 #14			MAX. 2 #8 w/ 2 #12

Wire Combinations: 2 #22 3 #22 3 #14 3 #12 3 #10 2 #8 w/ 2 #12

\*1,000 Volts signs and fixtures

# COMFORT Twister® WIRE CONNECTORS



# More POWER with every twist

The Wing-Nut® Wire Connector provides an easy, secure grip when connecting a wide range of wires. The specially designed contoured wings make for extra torque and quick work on any electrical job.

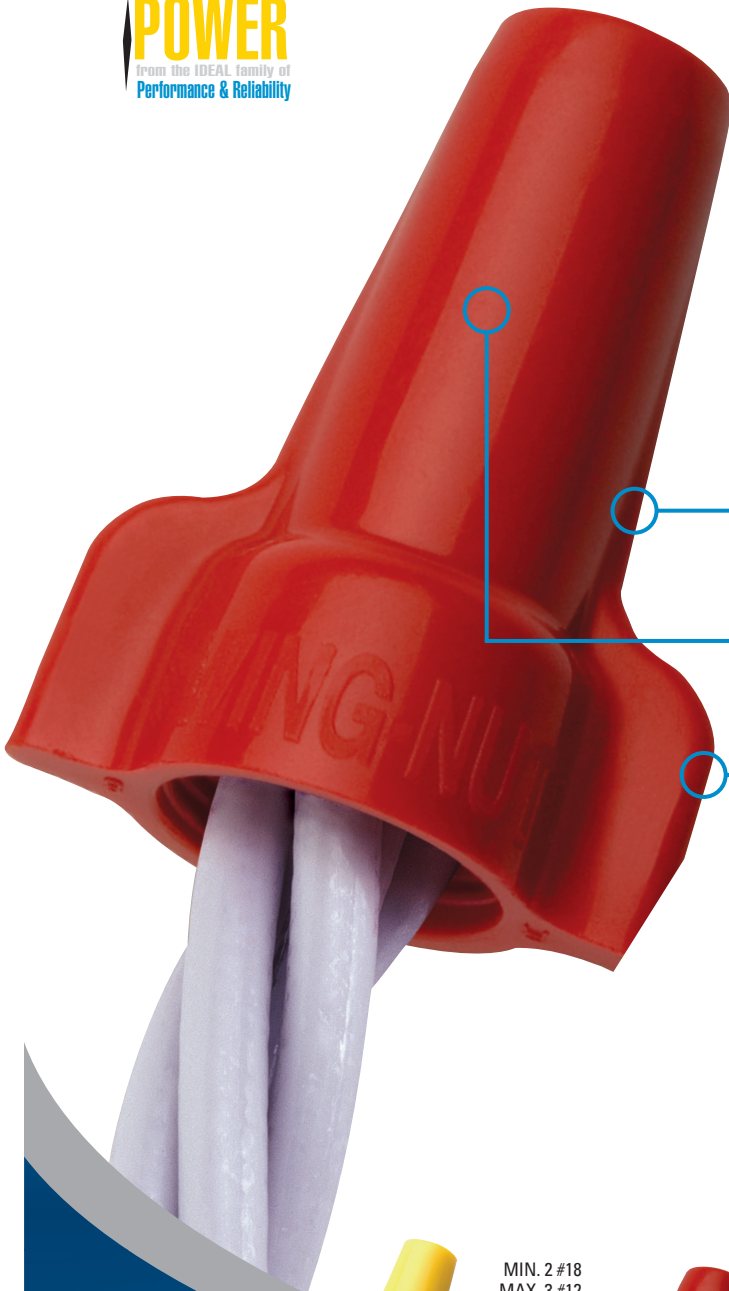

- Copolymer shell expands for smooth, progressive tightening
- Expanding, square-wire spring accommodates a wide range of wire sizes and combinations
- Contoured wing profile provides extra leverage for maximum torque



## Wing-Nut®

### FAST FACT:

The red Wing-Nut® will accommodate up to 4 #10 wires – **WIDEST IN THE INDUSTRY!**



MIN. 2 #18  
MAX. 3 #12



MIN. 2 #18  
MAX. 4 #10



MIN. 3 #12  
MAX. 1 #6 w/ 2 #8



Cu/Cu Only



# POWER

## Wing-Nut®

### WIRE CONNECTORS

WingNut® Wire Connector:

600 Volts Max.\*

451° Yellow	MIN. 2 #18	[Yellow bar spanning 2 #18 and 3 #12 columns]		MAX. 3 #12				
452° Red	MIN. 2 #18	[Red bar spanning 2 #18, 2 #14, 3 #12, 5 #12, and 4 #10 columns]				MAX. 4 #10		
454° Blue			MIN. 3 #12	[Blue bar spanning 3 #12, 5 #12, 4 #10, and 5 #10 columns]				MAX. 1 #6 w/ 2 #8

Wire Combinations: 2 #18 2 #14 3 #12 5 #12 4 #10 5 #10

\*1,000 Volts signs and fixtures





**COMPACT**  
from the IDEAL family of  
Performance & Reliability

CONSTRUCTION PRODUCTS  
**BUCHANAN**

# COMPACT low profile design gets you into tight spaces

The B-CAP® Wire Connector gets you in those hard-to-reach spots comfortably, especially when you're retrofitting or updating. With an expanding interior spring, this connector accepts a wide range of wire sizes and combinations.

Comfortable, "Classic Fin™" design provides a secure grip for extra leverage

Unique, space-saving profile is perfect for "old work" or shallow boxes

The B2 "Universal Connector" easily handles two #18, up to five #12; will even dead-end a single #14

**BCAP®**

**FAST FACT:**

The B-CAP® is extremely popular with veteran electricians because of its wide range and space-saving design.



MIN. 3 #20  
MAX. 3 #12

MIN. 2 #18  
MAX. 5 #12

MIN. 2 #12  
MAX. 2 #6



**COMPACT**

**B-CAP®**

WIRE CONNECTORS



600 Volts Max.\*

B-CAP® Wire Connector:

B1 Yellow	MIN. 3 #20				MAX. 3 #12	
B2 Red		MIN. 2 #18			MAX. 5 #12	
B4 Blue			MIN. 2 #12			MAX. 2 #6

Wire Combinations: 3 #20 2 #18 2 #12 3 #12 5 #12 2 #6

\*1,000 Volts signs and fixtures



# The connector for SPEED

The B-Twist™ Wire Connector combines all the features of red and yellow wire connectors in one unique design that comes to torque quick and easy. The rounded “dial-top” provides fast, fingertip starts and its low-profile design fits easily into electrical boxes. With a wide wire range, the B-Twist provides top performance at a great value.

Vertical ribs improve grip

Long swept-wings improve comfort and torque

Deep skirt helps protect over-stripped wires

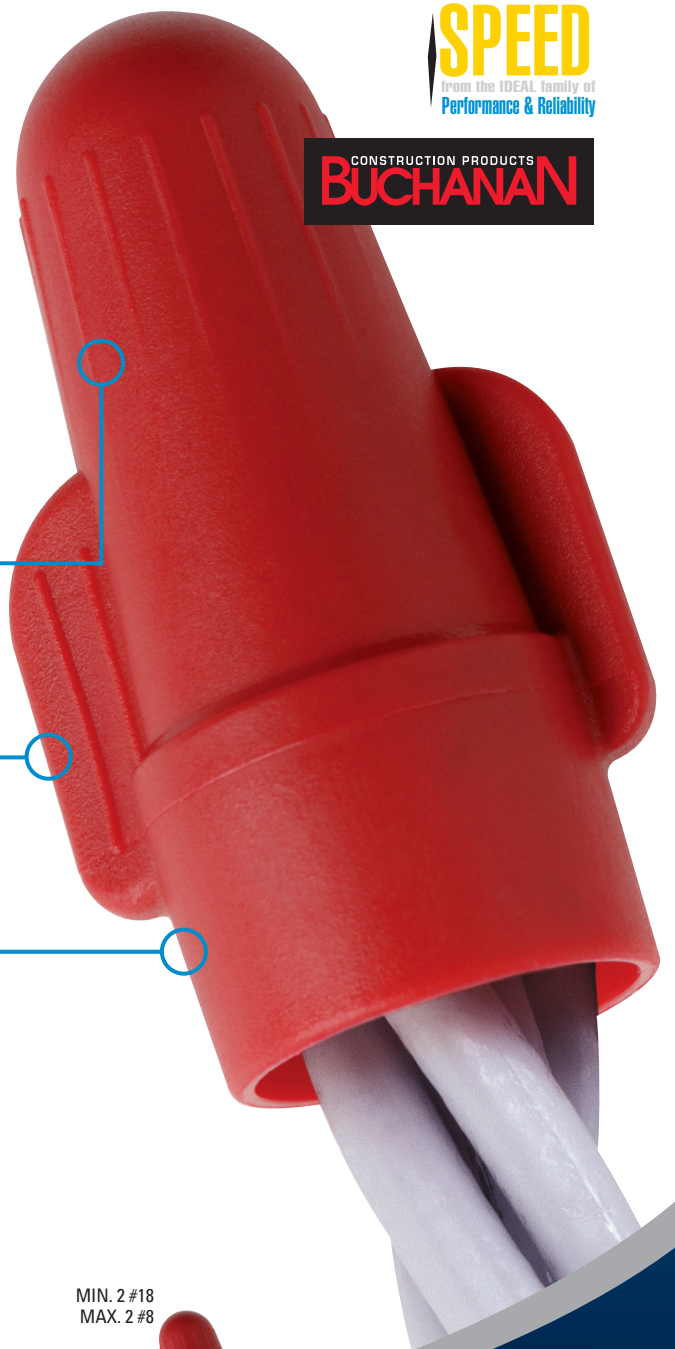

**FAST FACT:**

The B-Twist™ handles the entire range of a red and yellow connector

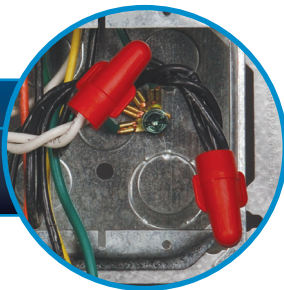

MIN. 2 #18  
MAX. 2 #8



Cu/Cu Only



B-Twist™ Wire Connector:



Wire Combinations: 2 #18 2 #14 3 #12 3 #10 5 #12 2 #8

\*1,000 Volts signs and fixtures

**SPEED**  
**B-Twist™**  
 WIRE CONNECTORS

# Great combination of performance and value

The contoured wing design of the WingTwist™ Wire Connector provides maximum torque for a variety of electrical applications.

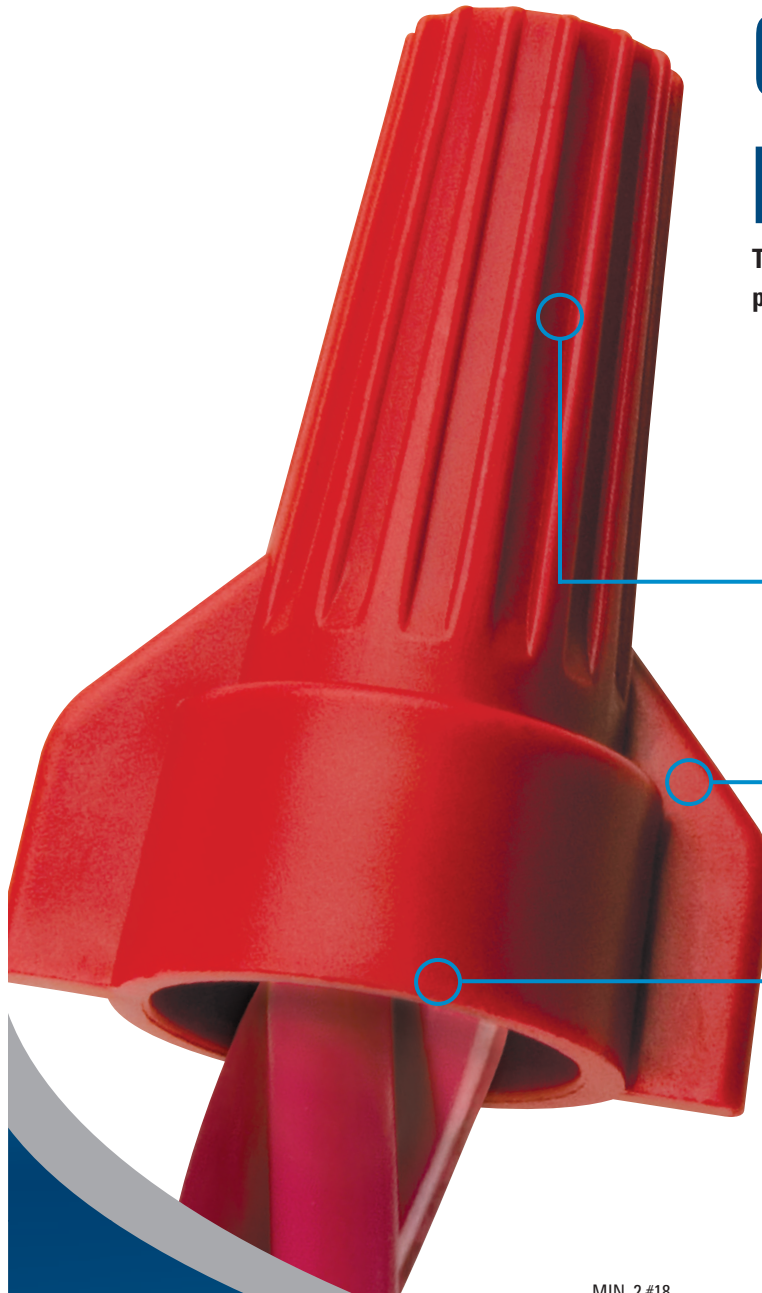

Ribs expand for progressive tightening

Contoured wing design improves leverage

Wide deep skirt opening accommodates a variety of wire combinations

## Wing-Twist™

### FAST FACT:

A full line for virtually every wire size and combination.

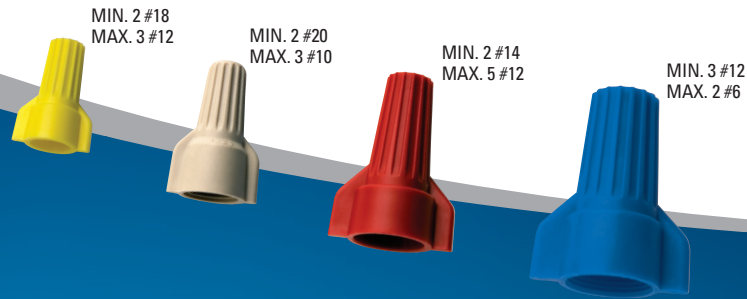

MIN. 2 #18  
MAX. 3 #12

MIN. 2 #20  
MAX. 3 #10

MIN. 2 #14  
MAX. 5 #12

MIN. 3 #12  
MAX. 2 #6

**WingTwist™**  
WIRE CONNECTORS

WingTwist™ Wire Connector:

WT51 Yellow		MIN. 2 #18		MAX. 3 #12		
WT41 Tan	MIN. 2 #20				MAX. 3 #10	
WT52 Red			MIN. 2 #14		MAX. 5 #12	
WT54 Blue				MIN. 3 #12		MAX. 2 #6

Wire Combinations: 2 #20 2 #18 2 #14 3 #12 5 #12 2 #6

UL LISTED Wire Connector 774A  
Cu/Cu Only  
LR9706  
600 Volts Max.\*

\*1,000 Volts signs and fixtures

# Exceptional value at every turn

The price is right for this economical connector that brings you a lot of value in comfort and performance.

Positive grip shell design

Flame-retardant shell rated at 105 °C (221 °F)

Multiple sizes accommodate a broad range of electrical applications

## Wire-Twist™

### FAST FACT:

Developed for projects on tight budgets.



Cu/Cu Only



#### WireTwist™ Wire Connector:

600 Volts Max.\*

WT1 Gray (300V)	MIN. 3 #22				MAX. 2 #16			
WT2 Blue (300V)		MIN. 3 #20			MAX. 3 #16			
WT3 Orange (600V)			MIN. 2 #18			MAX. 2 #14		
WT4 Yellow (600V)			MIN. 2 #18				MAX. 2 #12	
WT6 Red (600V)					MIN. 2 #14			MAX. 4 #12
<b>Wire Combinations:</b>	3 #22	3 #20	2 #18	2 #16	2 #14	2 #12	4 #12	

\*1,000 Volts signs and fixtures

**WireTwist™**  
WIRE CONNECTORS

# Connected and protected

Designed specifically for above grade, interior/ exterior connections exposed to damp/wet and corrosive environments. WeatherProof™ Wire Connectors are pre-filled with a non-hardening, silicone-based sealant that protects against moisture and corrosion.



Easy to apply, pre-filled twist-on wire connectors

Swept wing design is built for comfort and efficiency

UL Listed to 486D for use in damp or wet above-grade locations

## WeatherProof™

### FAST FACT:

The silicone-based sealant protects electrical connections against harsh conditions, eliminating the need for heat-shrink or excessive taping.

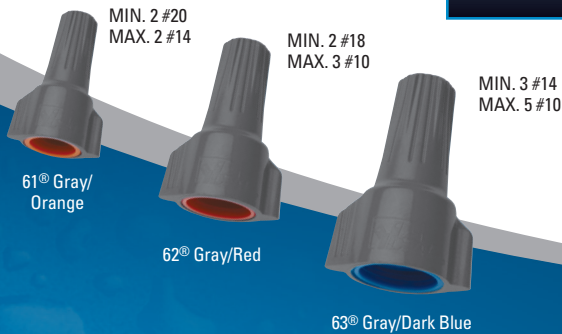
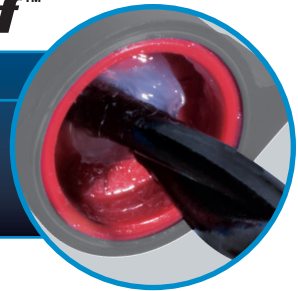

61® Gray/Orange  
MIN. 2 #20  
MAX. 2 #14

62® Gray/Red  
MIN. 2 #18  
MAX. 3 #10

63® Gray/Dark Blue  
MIN. 3 #14  
MAX. 5 #10



WeatherProof™  
WIRE CONNECTORS

WeatherProof™ Wire Connector:

61® Gray/Orange	MIN. 2 #20	MAX. 2 #14						
62® Gray/Red		MIN. 2 #16	MAX. 2 #10					
63® Gray/Dark Blue			MIN. 3 #14	MAX. 5 #10				

Wire Combinations: 2 #20 2 #16 2 #14 3 #14 3 #12 2 #10 5 #12 5 #10

\*1,000 Volts signs and fixtures



Cu/Cu Only



600 Volts Max.\*

# The connector made specifically for harsh underground environments

UnderGround™ Wire Connectors are designed to secure and protect connections in a wide variety of below-grade wet location and direct burial applications. Quick and easy application saves time and energy, eliminating the need for heat shrink, resin-packs, and multi-step corrosion kits.

Expanding, live-action square-wire spring for fast, secure, and long lasting connections

UL listed to 486D for use in damp/wet or direct burial/below-grade applications

Deep skirt provides superior moisture resistance to protect electrical connections

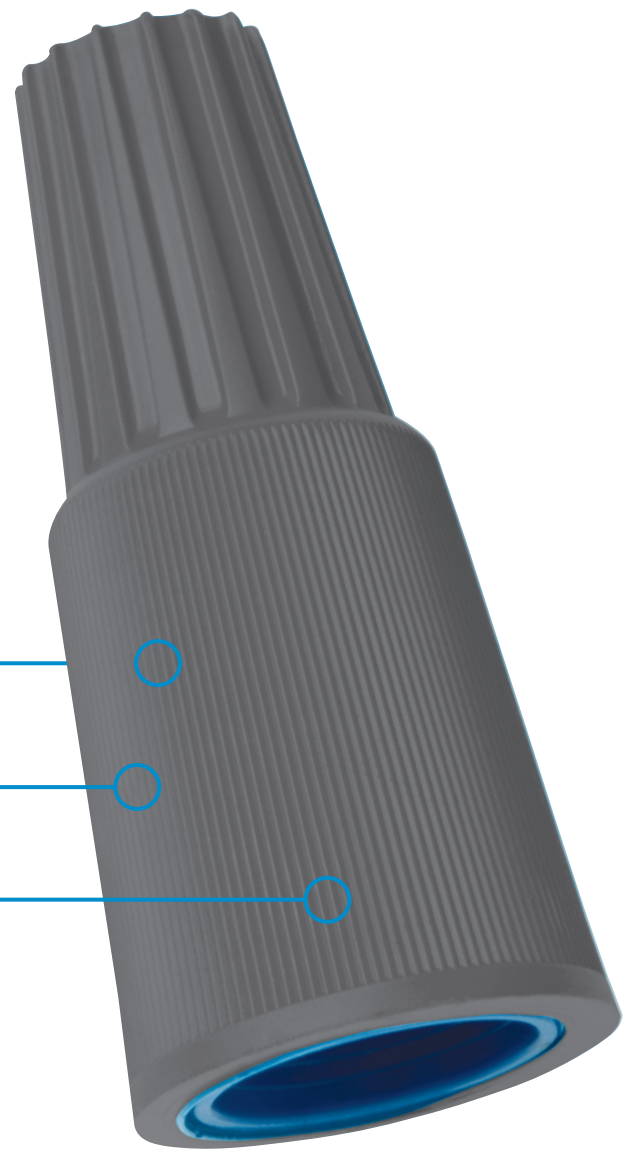

## UnderGround™

### FAST FACT:

Tough, thermoplastic shell provides extra protection against accidental impacts.



Perfect for utility tracer line applications.

MIN. 1 #20 w/1 #18  
MAX. 1 #10 w/2 #12

MIN. 2 #18  
MAX. 3 #10

MIN. 1 #20 w/1 #18  
MAX. 1 #10 w/2 #12

MIN. 2 #18 Sol.  
MAX. 3 #10

MIN. 3 #12  
MAX. 2 #6 w/1 #10



Cu/Cu Only



### UnderGround™/MudBug® Wire Connector:

60° Gray/Blue	MIN. 1 #20 w/1 #18					MAX. 1 #10 w/2 #12		
64° Gray/Dark Blue		MIN. 2 #18 Sol.					MAX. 3 #10	
66° Gray/Dark Blue				MIN. 3 #12			MAX. 2 #6 w/1 #10	
60° Yellow	MIN. 1 #20 w/1 #18					MAX. 1 #10 w/2 #12		
64° Yellow		MIN. 2 #18 Sol.					MAX. 3 #10	

Wire Combinations:

2 #20    2 #18    2 #16    2 #14    3 #12    3 #10    5 #10

600 Volts Max.\*

\*1,000 Volts signs and fixtures

UnderGround™ WIRE CONNECTORS

# The only twist-on for aluminum to copper connections

The Twister® Al/Cu Wire Connector is the only UL listed aluminum-to-copper twist-on connector that prevents aluminum oxidation while providing a secure connection. Anti-oxidant compound cuts through oxidation on aluminum conductors for improved conductivity and cooler connections.



Patented swept-wing design for comfortable connections

Pre-filled antioxidant compound prevents oxidation of aluminum conductors

Entry cap retains corrosion-resistant compound



## Twister® Al/Cu

### FAST FACT:

Aluminum wiring was common in 1970's era construction. The Twister® Al/Cu provides a solution for improved connections with today's copper wiring.



of U.S. and global components

Twister® Al/Cu  
WIRE CONNECTORS

Twister® Al/Cu Wire Combinations:

600 Volts Max.

1 #10 Al solid w/1 or 2 #10 Cu solid	1 #12 Al w/1 or 2 #14 Cu
1 #10 Al w/1 or 2 #12 Cu	2 #12 Al solid w/1 #14 Cu
2 #10 Al solid w/1 #12 Cu	1 #10 Al w/1 or 2 #18 Cu
1 #10 Al w/1 or 2 #14 Cu	2 #10 Al solid w/1 #18 Cu
2 #10 Al solid w/1 #14 Cu	1 #12 Al w/1 or 2 #16 Cu
2 #12 Al solid w/1 #10 Cu	2 #12 Al solid w/1 #16 Cu
1 #12 Al solid w/1 or 2 #10 Cu	1 #10 Al w/1 or 2 #16 Cu
1 #12 Al stranded w/1 or 2 #10 Cu solid	2 #10 Al solid w/1 #16 Cu
1 #12 Al w/1 or 2 #12 Cu	1 #12 Al w/1 or 2 #18 Cu
2 #12 Al solid w/1 #12 Cu	2 #12 Al solid w/1 #18 Cu

**WARNING:**

1. One time use only. Do not reuse connector.
2. Do not use on aluminum to aluminum wire combinations.
3. Wiring must comply with all applicable electrical codes.
4. Contact IDEAL for complete wire combination listing.



Cu/Cu Only



LR9706

# Fast, safe, efficient ballast installation

The IDEAL PowerPlug® Luminaire Disconnect is perfect for new lighting installations and retrofit lighting applications. It's the first push-in luminaire disconnect that fully meets the National Electrical Code for non-residential fluorescent fixtures with ballasts. [2005 NEC 410.73(G), 2008 and 2011 NEC 410.130(G)]

Patented IDEAL push-in technology quickly locks wires in place

Both halves are "touch-safe" per UL 2459

Fits through 1/2" knockout

**powerplug**®

Luminaire Disconnect

**FAST FACT:**

The PowerPlug® allows safe disconnect of hot and neutral ballast wiring.

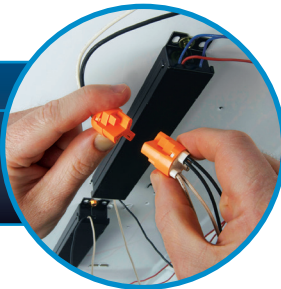

**PowerPlug® 102:** 6 Amps/600 Volts Max.

Wire Range	Line Side/Ballast Side
Solid	#12 - #18
Stranded	#12 - #14 (19 strand or less)
Stranded	#12 - #14 (19 strand or less)
Tin-Bonded	#16 (26 strand or less) #18 (16 strand or less)

**PowerPlug® 103:** 6 Amps/600 Volts Max.

Wire Range	Line Side	Ballast Side
Solid	#12 - #18	#18
Stranded	#12 - #14 (19 strand or less)	None
Stranded	#12 - #14 (19 strand or less)	#18 (16 strand or less)
Tin-Bonded	#16 (26 strand or less) #18 (16 strand or less)	

**PowerPlug® 182/183:** 3 Amps/120 Volts Max.

Wire Range	Line Side/Ballast Side
Solid	#18

**PowerPlug**®  
LUMINAIRE DISCONNECT



# A faster alternative to the butt-splice

The SpliceLine® In-Line Wire Connector provides a crimp-free, solderless butt-splice. The two-port model supports a wide range of wires, allowing one connector to do the job of three butt-splices. Its end-to-end connection is also a great solution for pre-fab operations.

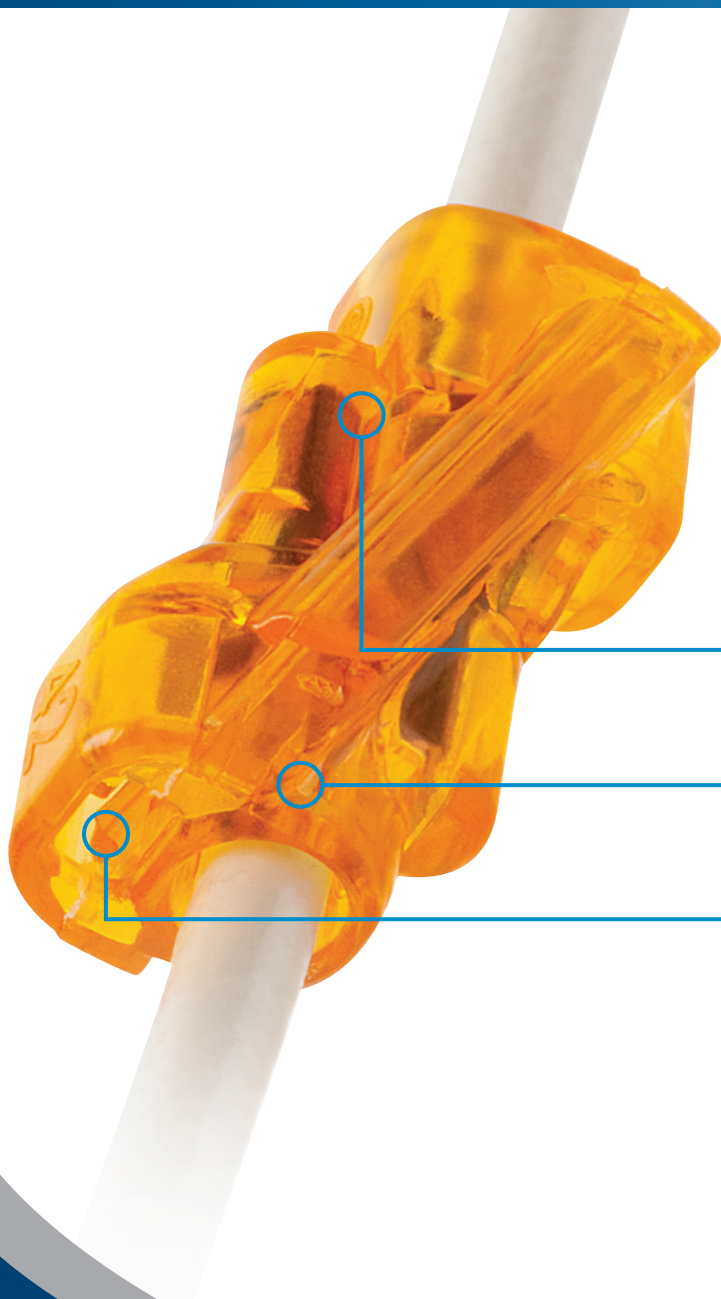

Transparent polycarbonate shell allows for visual inspection of connection

Slim design fits through 1/2" knockout

Check port for continuity testing

## SpliceLine® IN-LINE WIRE CONNECTORS

### FAST FACT:

Perfect for lengthening short wires, the SpliceLine® is 2X faster than traditional butt-splices.



42  
2-Port



**SpliceLine®**  
WIRE CONNECTORS

SpliceLine® Model 42: 600 Volts Max.

Solid	#20 – #12 solid
Stranded	#16 – #12 (19 strand or less)
Stranded Tin-Bonded	#18 – #14 (19 strand or less)

For use on insulation types TFN, TFFN, THHN, XHHW, T90 nylon or equivalent.



Cu/Cu  
Only



# Strip, Push, Connect- The fastest way to make a connection

The In-Sure™ Push-In wire connector is perfect for residential, light commercial, lighting retrofit and pre-fab wiring systems. The fastest, easiest, no-twist push-in connector on the market.

Clear shell allows visual inspection of the connection

No-twist push-in design reduces repetitive motion fatigue

Full line accommodates #20 – #12, 2 to 4 wire connections

## In-Sure™

### FAST FACT:

The In-Sure™ Push-In has low insertion force for fast, easy connections. Great for pre-fab wiring.

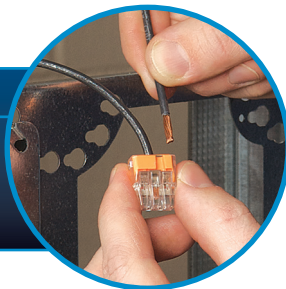

Cu/Cu Only



32  
2-Port



33  
3-Port



34  
4-Port

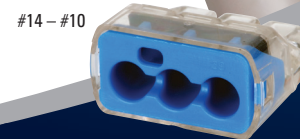

39  
3-Port

ACCEPTS  
#10 AWG

**In-Sure™ Models 32, 33, 34:**

600 Volts Max.

Solid	#20 – #12 solid
Stranded	#16 – #12 (19 strand or less) #18 (7 strand)
Stranded Tin-Bonded	#18 – #14 (19 strand or less)

**In-Sure™ Model 39:**

600 Volts Max.

Solid	#14 – #10 solid
Stranded	#12 – #10 (19 strand or less)
Stranded Tin-Bonded	#14 – #10 (19 strand or less)

In-Sure™ Push-In  
WIRE CONNECTORS

# We've got grounding covered

Grounding Pigtails are designed for a wide variety of grounding applications. The ultra-flexible lead wire and bonding jumpers make for fast and efficient pigtailing.

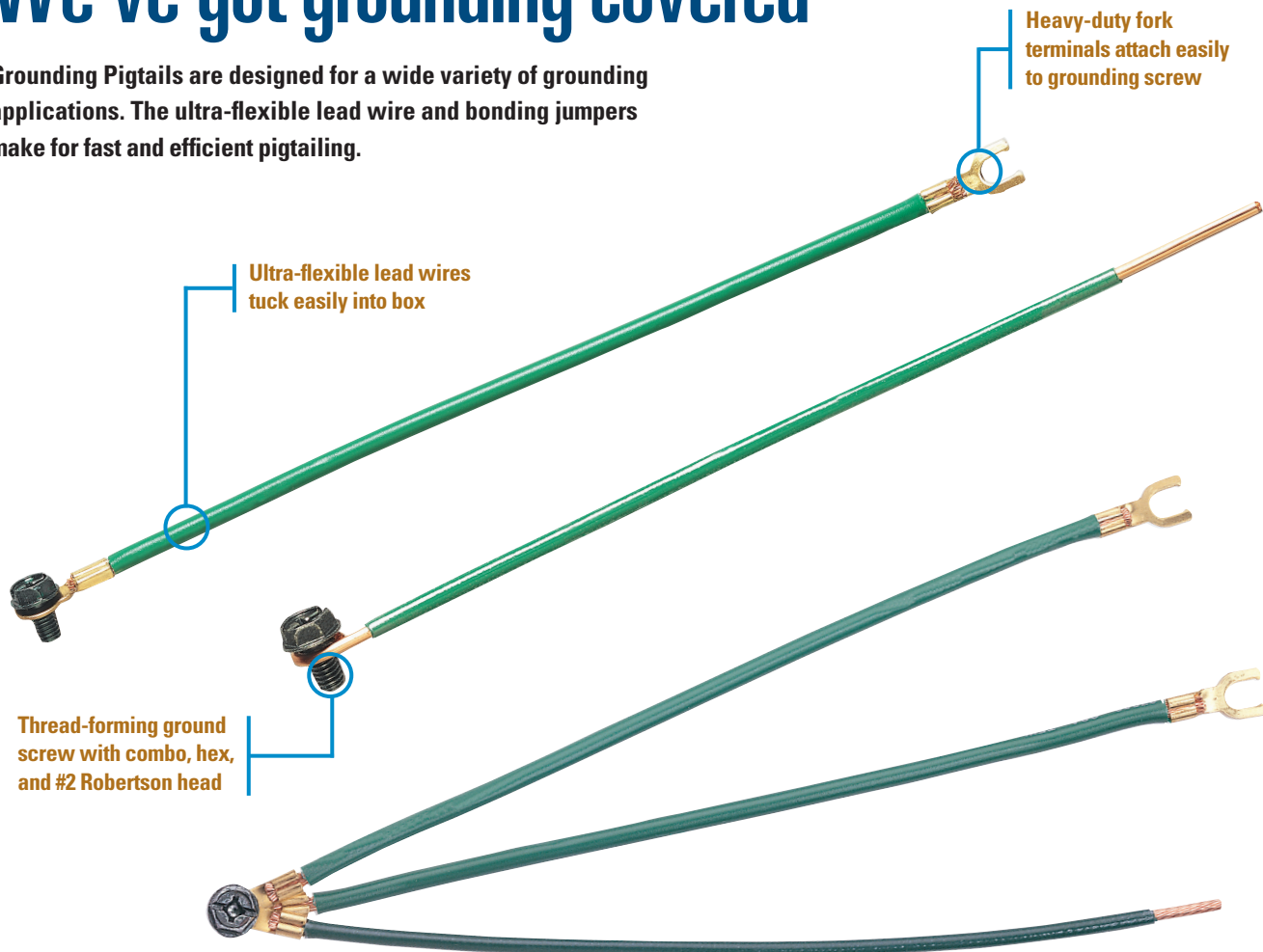

Ensures compliance with NEC standards

MIN. 2 #14  
MAX. 3 #12 w/1 #14

MIN. 2 #14  
MAX. 5 #12

MIN. 2 #14  
MAX. 5 #12



Grounding

## Greenie®, Green-B® & WGR Grounding Connectors

Designed for making ground connections and bonding non-metallic sheathed cable

UL Listed and CSA Certified; fully meets the intent of NEC sections 250.146 and 250.148

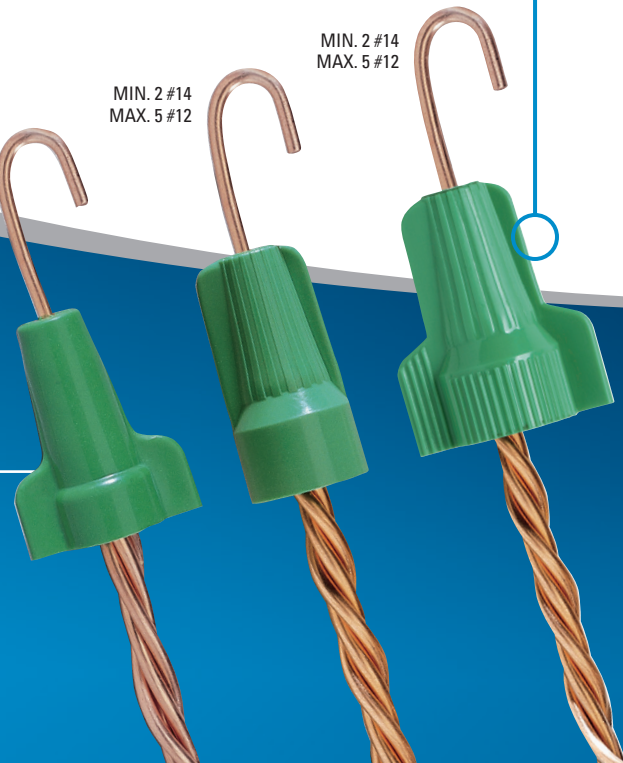

Cu/Cu Only





# Application Guide

Model:	RESIDENTIAL								COMMERCIAL									
	Light Switches	Receptacles	Ceiling Fans	Can Lights	Thermostat Controls	HVAC	Smoke/CO2 Detectors	Garage Door Opener	Door Bells	Multi-Gang Switch Boxes	Security Systems	Intercoms	Recessed Lighting	Controls	Illuminated Signage	Receptacles	3-Phase Motors	HVAC
<b>Twister®</b>																		
340® Lt. Blue	●		●	●			●		●	●	●							
341® Tan	●	●					●	●	●									●
344® Red/Yellow	●	●					●		●				●	●	●	●	●	●
342® Gray	●												●	●			●	●
<b>Wire-Nut®</b>																		
71B® Gray	●						●			●	●							
72B® Blue	●						●	●										●
73B® Orange	●		●	●					●	●	●							●
74B® Yellow	●	●	●	●					●				●	●				
76B® Red	●	●					●						●	●	●	●	●	●
<b>Wing-Nut®</b>																		
451® Yellow	●	●	●	●					●									●
452® Red	●	●					●						●	●	●	●	●	●
454® Blue	●												●	●			●	●
<b>B-CAP®</b>																		
B1 Yellow	●		●	●					●									●
B2 Red	●	●					●						●	●	●	●	●	●
B4 Blue	●												●	●			●	●
<b>B-Twist™</b>																		
BT2™ Red	●	●					●						●	●	●	●	●	●
<b>WingTwist™</b>																		
WT51 Yellow	●		●	●					●									●
WT41 Tan	●	●					●	●	●									●
WT52 Red	●	●					●		●				●	●	●	●	●	●
WT54 Blue	●												●	●			●	●
<b>WireTwist™</b>																		
WT1 Gray	●						●			●	●							
WT2 Blue	●						●	●										●
WT3 Orange	●		●	●					●	●	●							●
WT4 Yellow	●	●	●	●					●				●	●				●
WT6 Red	●	●					●						●	●	●	●	●	●



Model:	RESIDENTIAL								COMMERCIAL									
	Landscape Lighting	Pool Filters/Controls	Outdoor Power Outlets	Patio/Deck Lighting	Bathroom/Spa Vent Fans	Security Systems	Basement/Garage	Lawn-Sprinkler Controls	Sump/Well Pumps	Landscape Lighting	Security Systems	Exterior Lighting	Street/Parking Lot Lighting	Car Washes	Processing Plants	Traffic Signals	Ejection Pumps	HVAC
<b>WeatherProof™</b>																		
61® Gray/Orange					●	●		●		●			●	●	●			●
62® Gray/Red		●	●	●						●			●	●				●
63® Gray/Dark Blue		●	●	●						●			●	●				●
<b>UnderGround™</b>																		
60® Gray/Blue	●				●	●				●					●	●		
64® Gray/Dark Blue	●				●					●					●	●		
66® Gray/Dark Blue													●					●

## Ordering Guide



### Twister® Wire Connectors

Model	Quantity	Cat. No.
 340° Lt. Blue	Box of 100	<b>30-340</b>
	Jar of 500	<b>30-640J</b>
	Barrel of 35,000	<b>30-840</b>
 341° Tan	Box of 100	<b>30-341</b>
	Jar of 400	<b>30-441J</b>
	Bag of 500	<b>30-641</b>
	Jar of 750	<b>30-341J</b>
	Carton of 1,000	<b>30-541</b>
 342° Gray	Box of 50	<b>30-342</b>
	Bag of 250	<b>30-642</b>
	Barrel of 15,000	<b>30-842</b>
 344° Red/Yellow	Box of 50	<b>30-144</b>
	Jar of 250	<b>30-244J</b>
	Jar of 500	<b>30-644J</b>
	Barrel of 20,000	<b>30-944</b>

### Wing-Nut® Wire Connectors



Model	Quantity	Cat. No.
 451° Yellow	Box of 100	<b>30-451</b>
	Jar of 225	<b>30-451J</b>
	Jar of 500	<b>30-651J</b>
	Bag of 250	<b>30-651</b>
	Barrel of 35,000	<b>30-851</b>
 452° Red	Box of 100	<b>30-452</b>
	Jar of 300	<b>30-452J</b>
	Jar of 500	<b>30-652J</b>
	Bag of 500	<b>30-652</b>
 454° Blue	Box of 25	<b>30-454</b>
	Bag of 500	<b>30-654</b>
	Carton of 250	<b>30-554</b>

### Wire-Nut® Wire Connectors

Model	Quantity	Cat. No.
 71B° Gray	Box of 100	<b>30-071</b>
	Keg of 25,000	<b>30-271</b>
	Barrel of 150,000	<b>30-871</b>
 72B° Blue	Box of 100	<b>30-072</b>
	Keg of 10,000	<b>30-272</b>
	Barrel of 85,000	<b>30-872</b>
 73B° Orange	Box of 100	<b>30-073</b>
	Jar of 300	<b>30-073J</b>
	Bag of 500	<b>30-273</b>
	Barrel of 50,000	<b>30-873</b>
 74B° Yellow	Box of 100	<b>30-074</b>
	Jar of 175	<b>30-074J</b>
	Bag of 500	<b>30-274</b>
	Barrel of 35,000	<b>30-874</b>
 76B° Red	Box of 100	<b>30-076</b>
	Bag of 250	<b>30-276</b>
	Barrel of 15,000	<b>30-876</b>

Other package configurations available.  
Please contact IDEAL or your local  
IDEAL distributor for more information.

### B-CAP® Wire Connectors

Model	Quantity	Cat. No.
 B1 Yellow	Box of 100	<b>B1-1</b>
	Jar of 250	<b>B1-250JR</b>
	Jar of 500	<b>B1-500JR</b>
	Bag of 500	<b>B1-B</b>
	Barrel of 25,000	<b>B1-SK</b>
 B2 Red	Box of 100	<b>B2-1</b>
	Jar of 350	<b>B2-350JR</b>
	Jar of 500	<b>B2-500JR</b>
	Bag of 500	<b>B2-B</b>
	Barrel of 25,000	<b>B2-SK</b>
 B4 Blue	Box of 25	<b>B4-1</b>
	Carton of 250	<b>B4-B</b>





### B-Twist™ Wire Connectors

Model	Quantity	Cat. No.
 BT2™ Red	Box of 100	<b>BT2-1</b>
	Jar of 500	<b>BT2-500JR</b>
	Barrel of 25,000	<b>BT2-SK</b>



### WingTwist™ Wire Connectors

Model	Quantity	Cat. No.
 WT51 Yellow	Box of 100	<b>WT51-1</b>
	Bag of 500	<b>WT51-B</b>
	Jar of 500	<b>WT51-500JR</b>
	Barrel of 25,000	<b>WT51-SK</b>
 WT41 Tan	Box of 100	<b>WT41-1</b>
	Bag of 500	<b>WT41-B</b>
	Jar of 500	<b>WT41-500JR</b>
	Barrel of 25,000	<b>WT41-SK</b>
 WT52 Red	Box of 100	<b>WT52-1</b>
	Bag of 500	<b>WT52-B</b>
	Jar of 500	<b>WT52-500JR</b>
	Barrel of 25,000	<b>WT52-SK</b>
 WT54 Blue	Box of 50	<b>WT54-1</b>
	Bag of 100	<b>WT54-B</b>



### WireTwist™ Wire Connectors

Model	Quantity	Cat. No.
 WT1 Gray	Box of 100	<b>WT1-1</b>
	Bag of 500	<b>WT1-B</b>
 WT2 Blue	Box of 100	<b>WT2-1</b>
	Bag of 500	<b>WT2-B</b>
	Keg of 50,000	<b>WT2-SK</b>
 WT3 Orange	Box of 100	<b>WT3-1</b>
	Bag of 500	<b>WT3-B</b>
	Barrel of 50,000	<b>WT3-SK</b>
 WT4 Yellow	Box of 100	<b>WT4-1</b>
	Bag of 500	<b>WT4-B</b>
	Barrel of 25,000	<b>WT4-SK</b>
 WT6 Red	Box of 100	<b>WT6-1</b>
	Bag of 250	<b>WT6-B</b>
	Barrel of 25,000	<b>WT6-SK</b>



### WeatherProof® Wire Connectors

Model	Quantity	Cat. No.
61®/62®	Asst., Card of 10	<b>30-6162</b>
 61® Gray/Orange	Card of 25	<b>30-1161</b>
	Jar of 150	<b>30-1261J</b>
	Box of 1,000	<b>30-1361</b>
	Card of 20	<b>30-1162</b>
 62® Gray/Red	Jar of 100	<b>30-1262J</b>
	Box of 1,000	<b>30-1362</b>
	Card of 15	<b>30-1163</b>
 63® Gray/Dk. Blue	Jar of 50	<b>30-1263J</b>
	Box of 1,000	<b>30-363</b>

### UnderGround® Wire Connectors

Model	Quantity	Cat. No.
60®/64®	Asst., Card of 10	<b>30-6064</b>
 60® Gray/Dk. Blue	Card of 25	<b>30-1160</b>
	Carton of 100	<b>30-1260</b>
	Carton of 1,000	<b>30-1630</b>
 64® Gray/Dk. Blue	Carton of 50	<b>30-1264</b>
	Box of 1,000	<b>30-1364</b>
 66® Gray/Dk. Blue	Box of 50	<b>30-1066</b>





### MudBug® Utility Wire Connectors

Model	Quantity	Cat. No.
 60® Yellow	Box of 25	<b>30-160Y</b>
	Box of 1,000	<b>30-360Y</b>
 64® Yellow	Box of 25	<b>30-164Y</b>

### Twister® Al/Cu Wire Connectors

Model	Quantity	Cat. No.
 65 Purple	Card of 2	<b>30-065</b>
	Card of 10	<b>30-765</b>
	Card of 25	<b>30-165</b>
	Box of 100	<b>30-265</b>
	Carton of 1,000	<b>30-365</b>

### PowerPlug® Luminaire Disconnects





Model	Quantity	Cat. No.
 102 2-Pole	Card of 25	<b>30-372</b>
	Jar of 75	<b>30-382J</b>
	Jar of 150	<b>30-352J</b>
	Carton of 1,000	<b>30-102</b>
	Card of 20	<b>30-383X</b>
 103 3-Pole	Jar of 50	<b>30-383XJ</b>
	Jar of 100	<b>30-353XJ</b>
	Carton of 1,000	<b>30-103X</b>
	Box of 100	<b>30-082</b>
 182 2-Pole	Carton of 2,500	<b>30-682</b>
	w/6" leads, Carton of 1,000	<b>30-682L*</b>
 183 3-Pole	Box of 100	<b>30-083</b>
	Carton of 2,500	<b>30-683</b>

\*8 -10 week lead time.







### SpliceLine™ Wire Connectors

Model	Quantity	Cat. No.
 42 Orange	Bag of 10	<b>30-1342S</b>
	Box of 100	<b>30-1042</b>
	Jar of 300	<b>30-1042J</b>
	Box of 2,500	<b>30-1642</b>

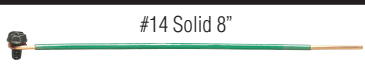
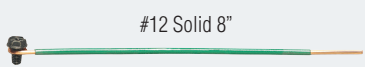

### In-Sure™ Push-In Wire Connectors

Model	Ports	Quantity	Cat. No.
 32 Red	2	Box of 100	<b>30-1032</b>
		Jar of 300	<b>30-1032J</b>
		Box of 5,000	<b>30-1632</b>
 33 Orange	3	Box of 100	<b>30-1033</b>
		Jar of 250	<b>30-1033J</b>
		Box of 5,000	<b>30-1633</b>
 34 Yellow	4	Box of 100	<b>30-1034</b>
		Jar of 200	<b>30-1034J</b>
		Box of 5,000	<b>30-1634</b>
 39 Blue (#14-#10)	3	Box of 50	<b>30-1039</b>
		Jar of 150	<b>30-1039J</b>
		Box of 2,500	<b>30-1639</b>

### Grounding Products

Model	Quantity	Cat. No.
 #14 Solid 8"	Box of 50	<b>30-3390</b>
	Box of 50	<b>30-3392</b>
	Box of 100	<b>30-3399</b>
 #12 Solid 8"	Box of 100	<b>30-3399</b>
	Box of 1,000	<b>30-3496</b>
 #14 Stranded 7-3/4"	Bag of 25	<b>30-3183</b>
	Bag of 25	<b>30-3184</b>
 #12 Stranded 7-3/4"	Box of 50	<b>30-3385</b>
	Box of 1,000	<b>30-3284</b>
	Box of 500	<b>30-3286</b>
 #12 Stranded 7-3/4"	Bag of 25	<b>30-3287</b>
 #12 Stranded 7-3/4"	Bag of 25	<b>30-3288</b>
 #12 Stranded 7-3/4"	Bag of 25	<b>30-3289</b>

Other tail lengths, wire gauges, combinations and package configurations available.

Model	Quantity	Cat. No.
 92® Greenie®	Box of 100	<b>30-092</b>
	Jar of 150	<b>30-092J</b>
	Bag of 500	<b>30-292</b>
	Box of 1,000	<b>30-192</b>
 BGR Green-B®	Box of 50	<b>BGR-1</b>
	Keg of 2,500 (10 bags, 250 ea.)	<b>BGR-B</b>
 WGR Green	Box of 50	<b>WGR-1</b>
	Jar of 500	<b>WGR-500JR</b>
	Keg of 5,000 (20 bags, 250 ea.)	<b>WGR-B</b>
Model	Quantity	Cat. No.
 Ground Screw	Pack of 50	<b>30-3194</b>
	Jar of 100	<b>30-3594</b>

# Wire Range Chart

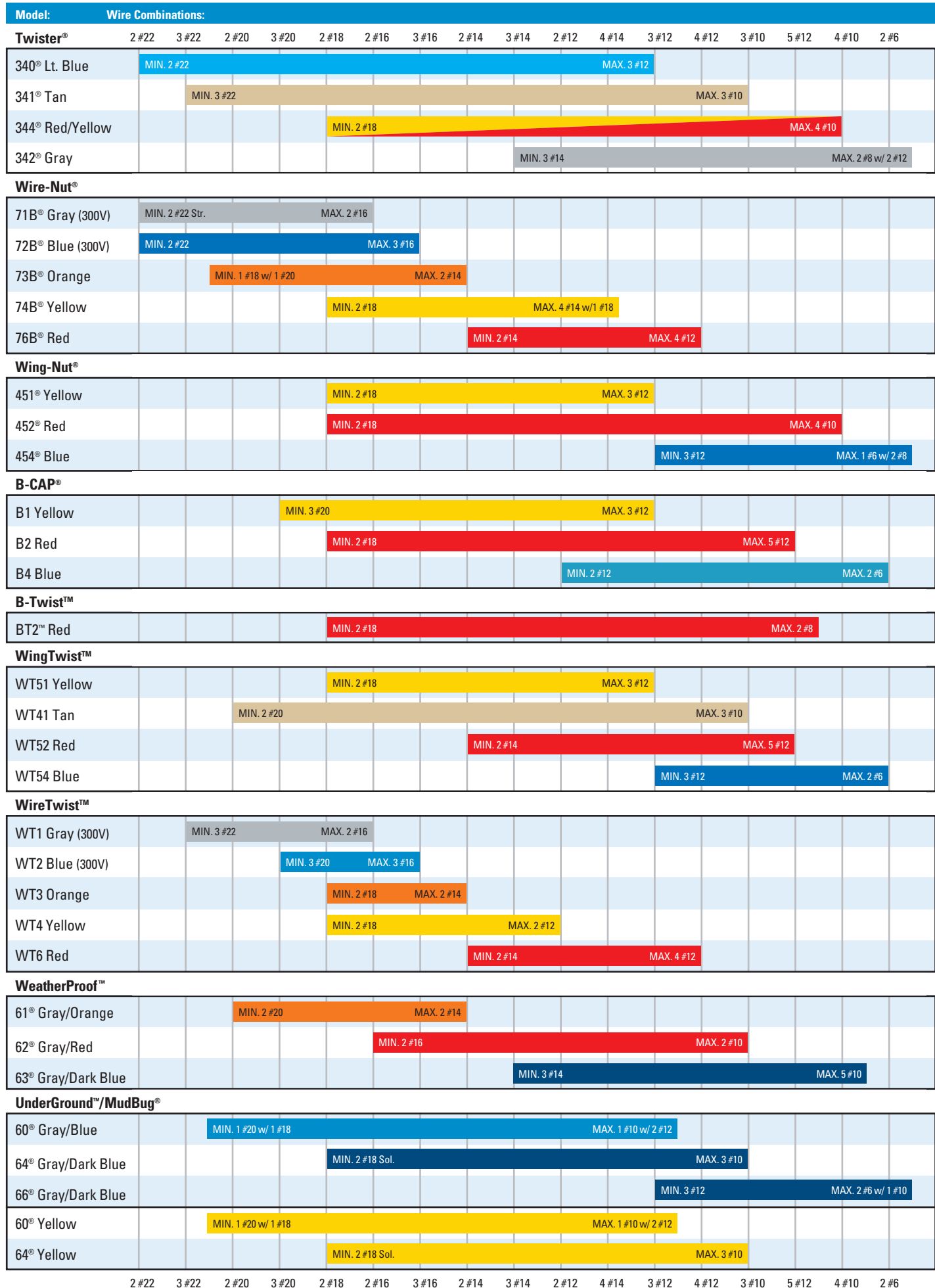

Comfort. Performance. Reliability.

# Premium Wire Connectors

**CLASSIC**



**Wire-Nut®  
Wire Connector**

The American **Classic** Since 1928.

**POWER**



**Wing-Nut®  
Wire Connector**

Brings More **Power** with Every Twist.

**COMFORT**



**Twister®  
Wire Connector**

More **Comfort**, Less Fatigue.

**COMPACT**



**B-CAP®  
Wire Connector**

**Compact** Size, Wide Range.

**FASTER**



**B-Twist™  
Wire Connector**

Comes to Torque **Quick** and Easy.