



Product Features:

Elegant Brass Hand Shower
Solid Brass Construction
1/4 Turn Ceramic Disc Cartridge
Swivel Spout
3-year Manufacturer Warranty

Free Standing Tub Filler Faucet Manual

Models: (BTF00-CHR) Buford, (BTF00-BN) Wallace



For easy installation of your Dyconn Faucet please do the following:

- Thoroughly read all instruction before installing the enclosed faucet.
- Read and understand all warnings, care and maintenance information.

Product Description & Information

The **Dyconn Faucet Free Standing Tub Filler Faucet** upholds the timeless essence of antique faucet design while incorporating the benefits of modern day technology and convenience. Introduce a nostalgic look to your bathroom with our tub filler faucet that has two ergonomic lever handles, a corrosion and tarnish resistant finish, and an elegant brass hand-shower that produces a truly enjoyable bathing experience.

CAREFULLY READ THIS INSTRUCTION MANUAL BEFORE INSTALLING AND USING THIS PRODUCT.

PLEASE KEEP THIS INSTRUCTION MANUAL FOR FUTURE REFERENCE FOR PRODUCT OPERATION AND MAINTENANCE.

Features:

- Elegant Brass Hand Shower
- Solid Brass Construction
- 1/4 Turn Ceramic Disc Cartridge
- Swivel Spout
- 3-Year Manufacturer Warranty

Package Contents:

- 1 - Free Standing Tub Filler Faucet
- 1 - Installation Accessories
- 1 - Hand Shower and Hose
- 2 - Cover Plate

Tools You Will Need:

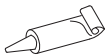

Plumber's putty



Pipe tape

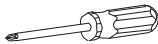

Philips Screwdriver



Pliers



Adjustable wrench

Product Diagram and Parts

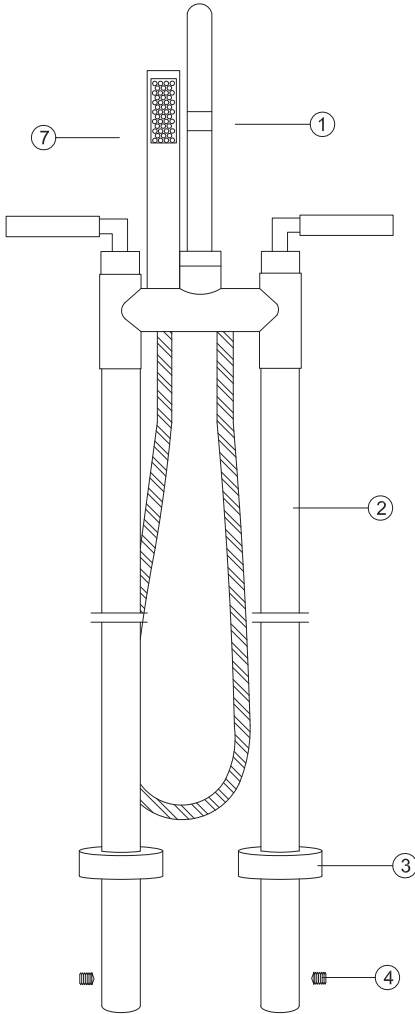

Model: BTF00-CHR or BTF00-BN

Accessory List:

1. Tub Filler Spout
2. Floor supply x 2
3. Floor Escutcheon x 2
4. Screw x 2
5. Self-tapping screw x 6
6. Base
7. Handshower and Hose

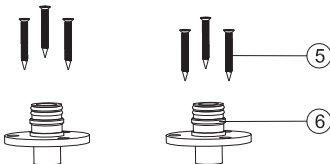

Faucet Installation Steps

Faucet Installation Steps

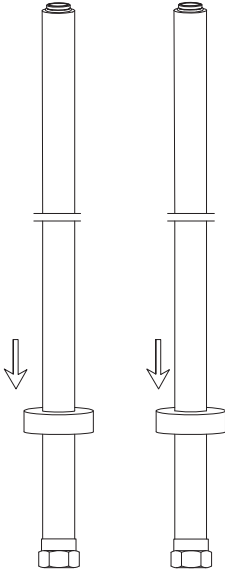

1. Slide floor escutcheons onto floor supplies

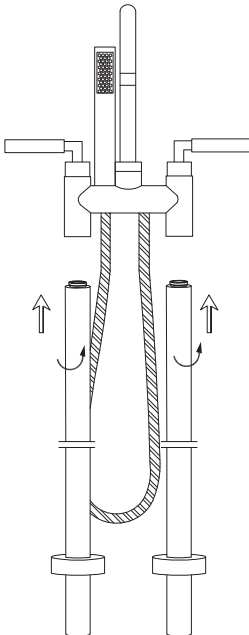

2. Install two seal washers into couplings. Align floor supplies with inlets of couplings. Thread couplings to floor supplies.

Faucet Installation Steps

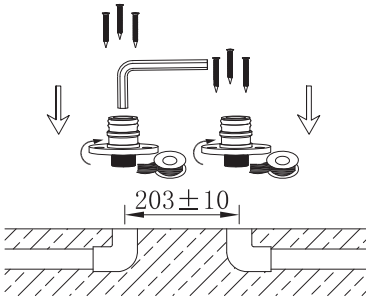

3. Wrap the threads on one end of the bases with pipe tape. Screw the bases into the female fittings and tighten with hex key.

Reinforce the bases to the floor by using self-tapping screws.

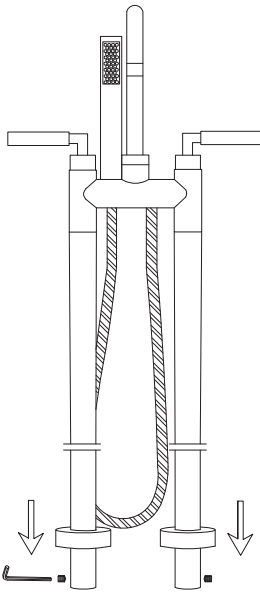

4. a. Insert the floor supplies onto the bases, and tighten with screw.
b. slide floor escutcheons down to the base of the floor supplies until flush with the floor.
c. Install the hose to the hand shower and the tub filler. Confirm tub filler spout and hand shower functionally.
d. Remove aerator assembly turn tub filler lever handle to the ON position initiating flow through the tub filler spout, and re-assembly the operator..
e. Confirm proper hot and cold flow through spout.

Remove the hand shower from the hose and direct towards the bath

- g. Turn the diverter lever to direct flow from the spout to the hand shower.
h. With water now flowing through the hand shower, check all hand shower hose connections for leaks and confirm proper flow through the hand shower.

- i. Turn tub filler handle OFF.

Manufacturer Limited Warranty

All Dyconn Faucet products are manufactured and tested with the highest quality standards and rigorous quality control process. This warranty is limited to the non-commercial use of Dyconn Faucet products purchased and installed in the United States and Canada.

Dyconn Faucet Brand Limited Warranty on Faucets and Kitchen/Bath Accessories

Dyconn Faucet warrants its faucet products to be free from manufacturing defects in material and workmanship during the normal non-commercial use for a period of three (3) years from the initial purchase date by the original owner/end-user for personal household use. Dyconn Faucet also warrants its part and accessory products to be free from manufacturing defects in material and workmanship during the normal non-commercial use for a period of one (1) year from the initial purchase date by the original owner/end-user for personal household use. This warranty is non-transferable between homes or owners and only applicable for residential use. Any commercial or industrial use of Dyconn Faucet products automatically voids the warranty. Any warranty claim must include the original sales receipt as proof of purchase from an Authorized Dealer or Distributor of Dyconn Faucet products. (Authorized Dealers can be found on the Dyconn Faucet website).

Dyconn Faucet recommends installation of all Dyconn Faucet products by a licensed professional plumber. Dyconn Faucet will not be responsible for any damage or product failure due to improper installation, misuse or the failure to adequately utilize a licensed professional. Proper care and maintenance for all products is standard, like any other household appliance and fixtures to ensure proper function and a lasting product. Instructions are provided in your manual on proper care and maintenance of Dyconn Faucet products.

This warranty will not cover any damages that might be caused by the product. (In some instances States do not allow for such limitations, so this may not apply to all owners).

Any product reported to Dyconn Faucet as defective will be repaired or replaced (with a product of equal value) at the option of Dyconn Faucet. If Dyconn Faucet is not able to replace or repair the product, Dyconn Faucet may elect to refund the original purchase price to the original purchaser in exchange for the return of product. Dyconn Faucet has the full rights to inspect any Dyconn Faucet product reported as defective prior to repair or replacement. Any repair and replacement costs EXCLUDE shipping, labor for removal or re-installation and any consequential or special damages associated with return, replacement and installation of your product. Replacement parts may be obtained by calling **1-855-239-2666** (in the U.S. and Canada), by emailing us at info@dyconnfaucet.com or writing to:

Dyconn Faucet – 382 N. Lemon Avenue #122, Walnut, CA 91789

Dyconn Faucet reserves the rights to modify the warranty at any time, it being understood that any such modifications will not supersede warranty conditions that are applicable at the time of the original sale of products in question.

Though Dyconn Faucet products are certified by various agencies, Dyconn Faucet makes no implication that products comply with any or all local building or plumbing codes. It is the consumer's responsibility to determine any code compliances when installing and using Dyconn Faucet products.

Limitations of Warranty:

The warranty shall be not apply and be void for incorrect operating procedures, breakages and/or damages caused by fault through improper installation, carelessness, abuse, misuse, misapplication, improper maintenance and alteration of product; damages caused by chemicals, natural corrosion, accident, fire, flood, an act of God, or any casualty. Avoid abrasive cleaners, materials, steel wools and harsh chemicals as these will scratch, damage, and/or dull the products and/or finish of the products and void the warranty. The proper installation of product covered is the responsibility of the original owner/purchaser of the product. Dyconn Faucet neither installs nor supervises the installation nor hires contractors for this purpose; consequently Dyconn Faucet cannot be held responsible for any default breakage, or damages caused thereby or resulting thereof, either directly or indirectly.

This warranty does not apply to Products that have not been installed or operated in accordance with instructions supplied by Dyconn Faucet and all applicable rules, regulations, and legislation pertaining to such installations.

This warranty does not apply to Commercial or Industrial applications of Dyconn Faucet products.

Dyconn Faucet is not responsible or liable for personal injuries or deaths to any person for any direct, special, incidental, or consequential damage, loss of time, loss of profits, inconvenience, incidental expenses, labor or material charges, or any other cost resulting from the use of the product or equipment or pertaining to the application of the present warranty, or resulting from the removal or replacement of any product or element or part covered by this warranty.

In any case, Dyconn Faucet is not liable for any amount over and above the purchase price paid for the Product by the original owner/end-user.

Cleaning and Care

Care should be exercised when cleaning this product. Although its finish is extremely durable, it can be damaged by harsh abrasives and cleaning pads. To clean, use a light, non-abrasive cleaning solution or cleaning polish.

 **DYCONN**