

# OWNER'S MANUAL

A guide to your intelligent floor cleaner

bObsweep PetHair Plus™

Model No. WPP56001

## Congratulations!

Congratulations on your new intelligent floor cleaner! Bob is now at your service. To see Bob at his best, please read the Quick Start Guide and this manual thoroughly. Welcome to the bObsweep family and happy cleaning!

If you have any questions or concerns, feel free to contact our helpful team at:  
[support@bobsweep.com](mailto:support@bobsweep.com).

6

Important Safety  
Instructions

8

What Comes in  
Bob's Box?

10

Bob's Anatomy

13

Cover Buttons

36

Cleaning Schedule

Set Bob's Cleaning  
Schedule 37  
Auto-Resume 41

44

Parts & Maintenance

Mop 46  
blOck Plus™ 48  
Dustbin 52  
Filter 54  
Main Brush 56  
Side Brush 58  
Battery 60  
Storing Bob 60

62

Sensors

Cleaning Bob's Sensors 63  
Deactivate Edge Sensors 64

67

Troubleshooting  
& Home Checkup  
Test

Troubleshooting 68  
Oops, there is some-  
thing wrong with my 69  
Home Checkup Test 73

15

Get Bob Ready  
to Clean

Install Side Brush 16  
Let Bob Charge 17  
Sync Bob's Charging  
Station & Remote 20  
Bob's First Clean 21

23

Charging Bob

Charging Station  
Placement 24  
Auto Charging 25  
Manual Charging 26  
Conserving Battery 27

29

Cleaning Modes

Deep Clean  
Quick Clean  
Touch Up  
Waffle Track™  
Spiral Track™  
Wall Track™

32

FullCommand™  
Remote

Syncing Bob's  
Remote 35

83

Warranty  
Information

84

Cleaning Behavior

85

Bob's Challenges

87

FAQs

## Important Safety Instructions

Basic safety precautions should always be followed, including the following:

Read ALL instructions before use.

To protect against electrical shock, do not immerse any part of Bob — with the exception of his mopping cloth — into water or other liquids.

Unplug Bob from outlet when not in use and before conducting maintenance.

Do not operate Bob or his charging station if they have been damaged in any way. If Bob is not working as he should, or has been dropped, damaged, left outdoors, or dropped in water, contact our customer care center at [support@bobsweep.com](mailto:support@bobsweep.com).

Do not handle Bob or his charging station with wet hands; use only on dry surfaces.

Do not use Bob outdoors.

Bob is not intended for use by persons (including children) with reduced physical or mental capabilities, or lack of experience and knowledge, unless under the close supervision of a person responsible for their safety.

Do not pull or carry the charging station by the cord, use the cord as a handle, close a door on the cord, or pull the cord around sharp edges or corners. Keep the cord away from heated surfaces. To unplug the cord, grasp the plug, not the cord itself.

Do not mutilate or incinerate the battery, as it will explode at high temperatures.

Do not attempt to open Bob's charging station. Repairs on his station should only be carried out by our qualified customer care center.

Do not expose Bob's charging station to high temperatures or allow moisture or humidity of any kind to come into contact with it.

Do not let Bob pick up toxic materials (chlorine bleach, ammonia, drain cleaner, etc.).

Do not let Bob pick up anything that is burning or smoking, such as cigarettes, matches, or hot ashes. Do not use Bob to pick up flammable or combustible liquids such as gasoline, nor use him in areas where they may be present.

Do not use Bob in an enclosed space filled with vapors given off by oil-based paint, paint thinner, moth-proofing substances, flammable dust, or other explosive or toxic vapors.

Leaks from battery cells can occur under extreme usage or temperature conditions. If the liquid gets on skin, wash quickly with water. If the liquid gets into the eyes, flush them immediately with clean water for a minimum of 10 minutes, and seek medical attention.

Do not use Bob for anything other than his intended purpose, as specified in this manual.

### Declaration of Conformity

This device complies with Part 15 of the FCC rules. Operation is subject to the following two conditions: (1) this device may not cause harmful interference, and (2) this device must accept any interference received, including interference that may cause undesired operation.

The manufacturer is not responsible for any radio or TV interference caused by unauthorized modifications or change to this equipment. Such modifications or change could void the user's authority to operate the equipment.

This equipment has been tested and found to comply with the limits for a Class B digital device, pursuant to part 15 of the FCC Rules. These limits are designed to provide reasonable protection against harmful interference in a residential installation. This equipment generates, uses and can radiate radio frequency energy and, if not installed and used in accordance with the instructions, may cause harmful interference to radio communications. However, there is no guarantee that interference will not occur in a particular installation. If this equipment does cause harmful interference to radio or television reception, which can be determined by turning the equipment off and on, the user is encouraged to try to correct the interference by one or more of the following measures:

- Reorient or relocate the receiving antenna.
- Increase the separation between the equipment and receiver.
- Connect the equipment into an outlet on a circuit different from that to which the is connected.
- Consult the dealer or an experienced radio/TV technician for help.

## What Comes in Bob's Box?

Bob, Your Intelligent Floor Cleaner **1**

Charging Station **2**

Blö Main Brush **3**

Charging Adapter **4**

FullCommand™ Remote Control **5**

blOck Plus™ **6**

Flat Head Screwdriver **7**

2 Side Brushes (1 Spare) **8**

Cleaning Tool **9**

Pack of Screws **10**

Mop Attachment **11**

2 Micro-Fiber Mopping Cloths **12**

Filter Replacement **13**

Bumper Stickers **14**

Owner's Manual, Quick Start Guide, and Warranty Card **15**

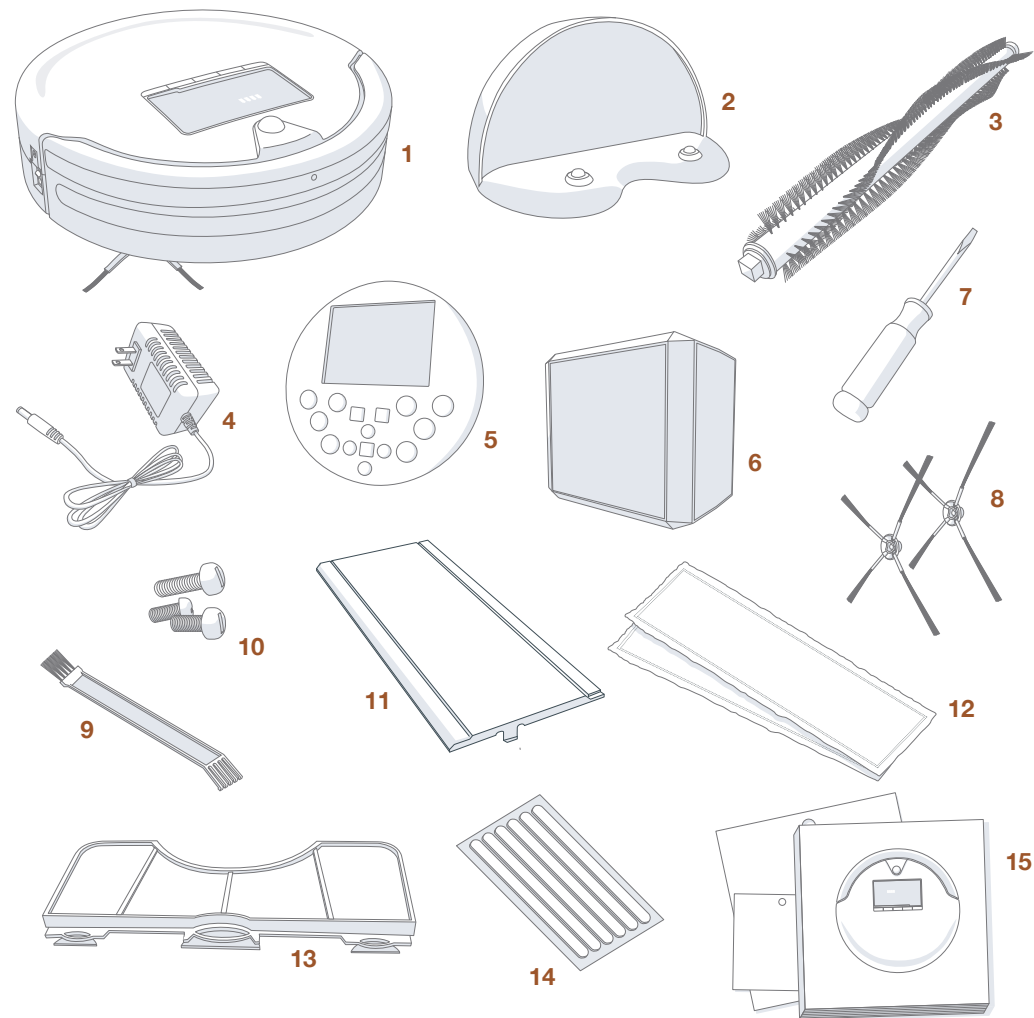

## Bob's Anatomy

### Top View

- Bumper **1**
- Signal Transmitter **2**
- Cover Buttons **3**
- Display **4**

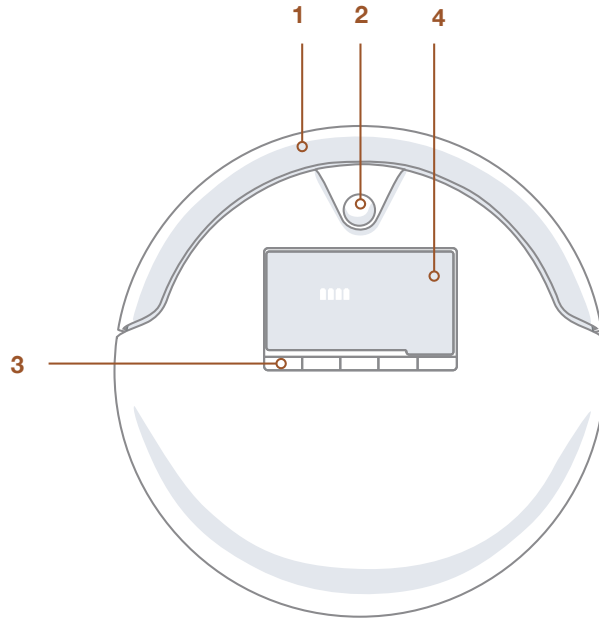

### Bottom View

- Charging Plates **1**
- Front Wheel **2**
- Side Brush **3**
- Main Brush **4**
- ON/OFF Switch **5**
- Charging Inlet (on Bob's side) **6**
- Dustbin **7**
- UV Lamp **8**
- Battery **9**
- Left and Right Wheels **10**

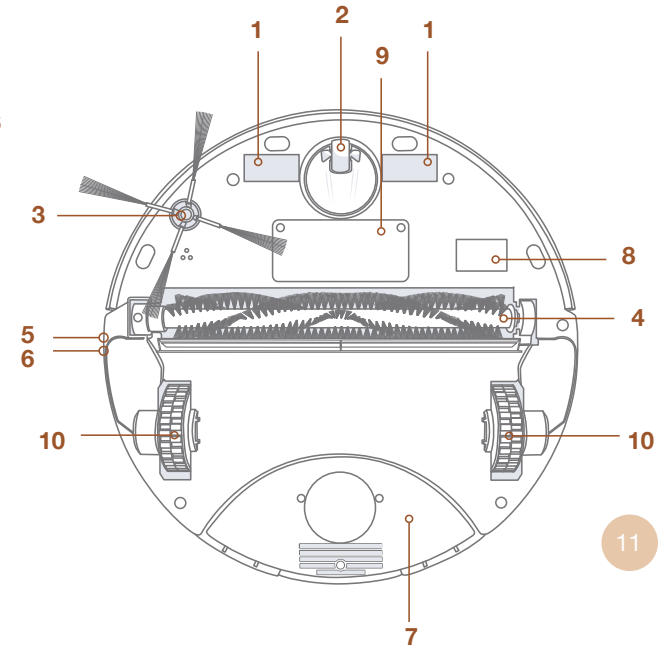

FullCommand™ Remote **1**

bIOck Plus™ **2**

Charging Station **3**

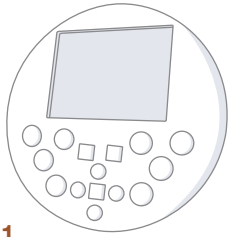

**1**

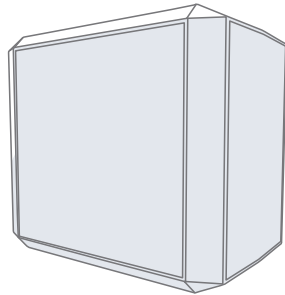

**2**

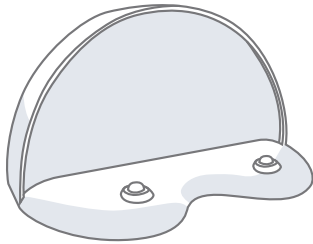

**3**

### Cover Buttons

#### GO! **1**

Bob will clean on his default setting

#### CLEANING MODE **2**

Select Bob's cleaning mode

#### CHARGE **3**

Send Bob to his charging station

#### MUTE **4**

Mute Bob's beeping

#### CHECKUP **5**

Put Bob in checkup mode / Deactivate edge sesors (page 59)

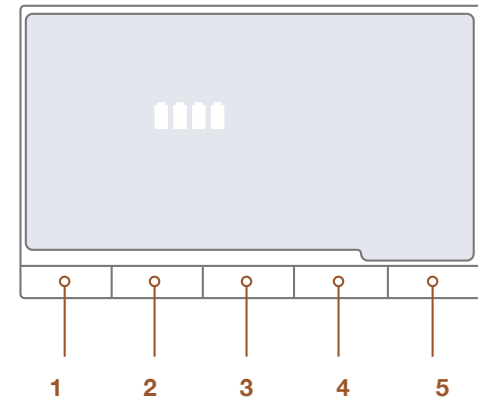

The background features a collection of abstract geometric shapes. On the left, there is a large blue circle with a dark blue circle overlapping its top-left edge. Below the blue circle is a grey circle with diagonal stripes. To the right of the blue circle is a smaller grey circle. In the top-left corner, there is a light brown circle with a dotted pattern. In the top-right corner, there is a solid light brown circle. In the center-right, there is a light brown circle with a dotted pattern. At the bottom, there is a large orange circle overlapping a light blue circle with a dotted pattern. On the right side, there is a blue circle overlapping a smaller orange circle with diagonal stripes. The text "Getting Bob Ready to Clean" is centered within a white circle that has a double-line border.

# Getting Bob Ready to Clean



## Install Bob's Side Brush

Before Bob's first clean, you must install his side brush, which allows him to sweep along corners, walls, and other hard-to-reach places.

To do this, you will need the following materials, all of which are included inside Bob's box: a side brush, a flat head screwdriver, and a short screw.

1

Flip Bob over onto a flat surface. Place the side brush over the empty socket on Bob's underside.

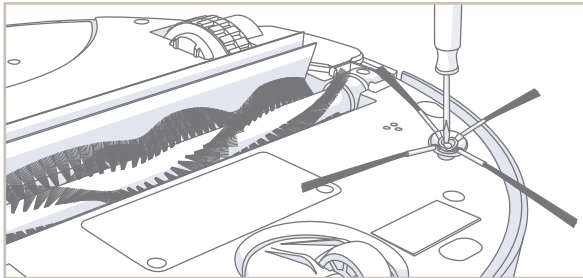

2

Secure Bob's side brush onto the socket using the flat head screwdriver and short screw.

3

You may use the additional side brush and screw as spares.

## Charge Bob

After installing Bob's side brush, you must now set him to charge.

1

Plug the charging adapter into the side of the charging station. The station's red power light will turn on.

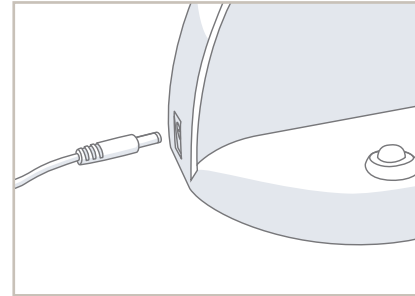

2

Place Bob on his charging station with the metal plates on his underbelly sitting on top of the nodes on his station.

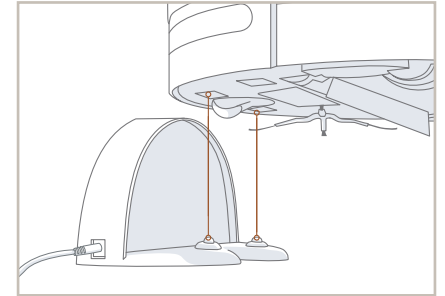

3

When Bob is charging, the battery bars on his display screen will flash and the word “Charging” will appear.

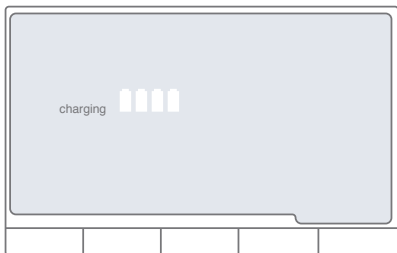

4

When Bob has fully charged, the battery bars will remain still and the word “Charging” will disappear.

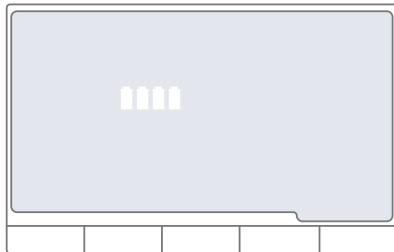

## Sync Bob's Charging Station and Remote

Bob will automatically return to his charging station when his battery reaches 15% capacity, but first you must sync him to it. You will only need to do this once.

To sync:

1

While the station is plugged in, hold down the SYNC button on the back of it.

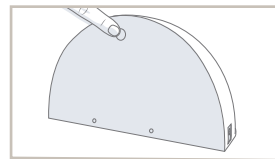

2

While still holding down the SYNC button, flip Bob's power switch ON.

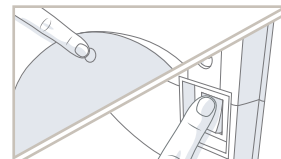

3

Bob will chirp twice to let you know the sync was successful.

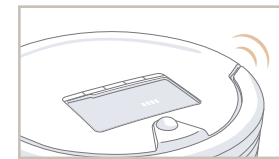

Bob will also need to be synced with his FullCommand™ remote to respond to its commands.

In order to do that:

1

Hold down the OK/SYNC button on Bob's remote.

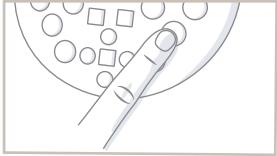

2

While still holding down the OK/SYNC button, flip Bob's power switch ON.

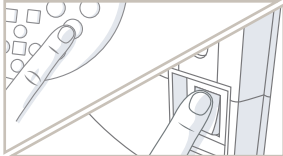

3

Bob will chirp twice to let you know the sync was successful.



Bob is now ready to clean!

Press the GO! button on his cover — or on his FullCommand™ remote — and he will clean on his default Deep Clean setting.

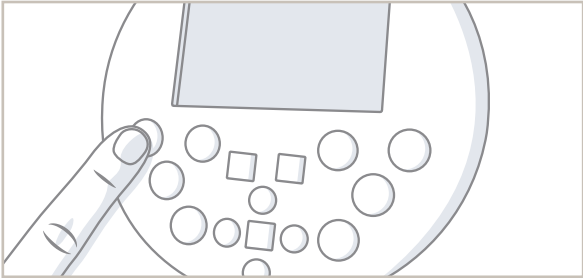



## Charging Station Placement

- Position the charging station against a wall on a hard, flat surface.
- Make sure there is at least 10 feet (3 meters) of open space to the front and 2 feet (0.5 meters) to the sides.

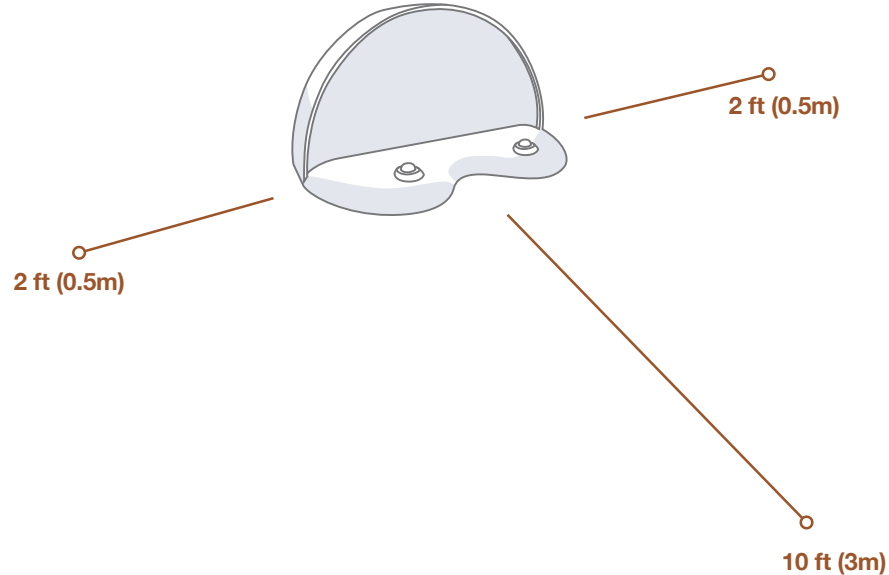

## Auto Charging

Bob is smart and will automatically search for his charging station when his battery reaches 15%. But first, you must sync the two to establish communication.

To sync the charging station:

1

Plug the charging adapter into the charging station. The station's red power light will turn on.

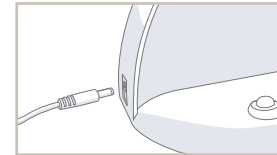

2

Hold down the SYNC button on the back of the charging station while at the same time flipping Bob's power switch ON.

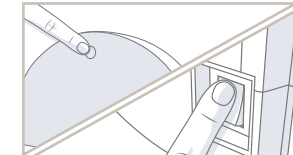

3

Bob will chirp twice to let you know the sync was successful.



You can also direct Bob to his charging station at any time by pressing the CHARGE button on his cover or on his FullCommand™ remote.

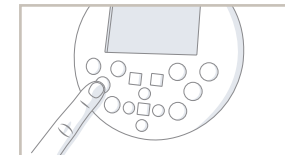
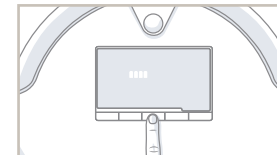

## Manual Charging

### Using the charging station:

- Place Bob directly onto his plugged-in charging station.
- Make sure his charging plates sit directly on top of the nodes on his station.

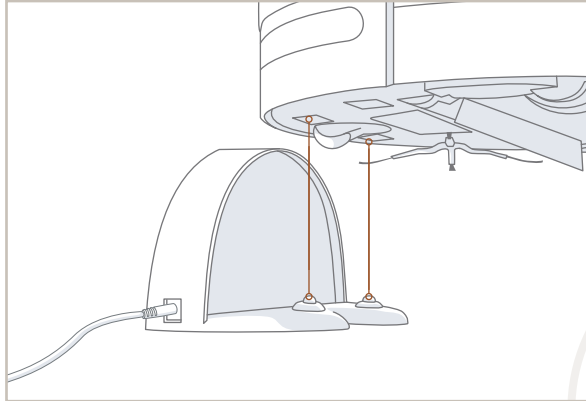

When Bob is charging, the battery bars on his display screen will flash and the word "Charging" will appear.

### Using the adapter:

- Plug the charging adapter directly into the inlet on Bob's side.

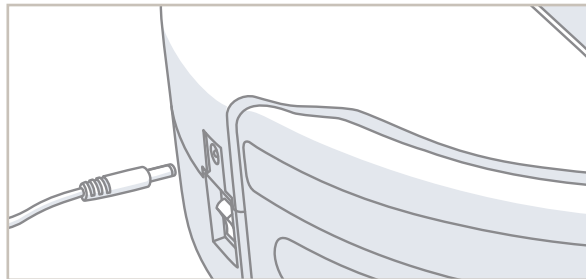

When Bob has fully charged, the battery bars will remain still and the word "Charging" will disappear.

## Conserving Bob's Battery

Bob should not sit on his charging station for more than 5 days. If you will not be using him at least once every 5 days, turn his side power switch OFF to conserve his battery.

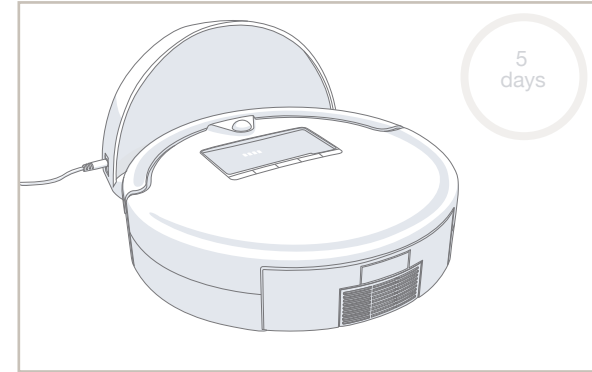



## Cleaning Modes

Bob is equipped with six cleaning modes:

Deep Clean

Quick Clean

Touch Up

Waffle Track™

Spiral Track™

Wall Track™

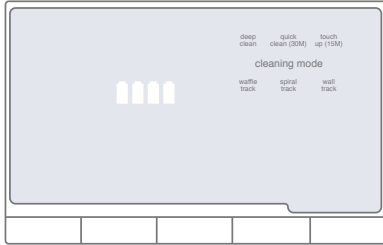

Bob will automatically return to his charging station after he completes each cycle. Choose the mode that best suits your cleaning needs.

To select any of these cleaning modes:

1

Press the CLEANING MODE button on Bob's cover until the mode you wish to select lights up on his screen.

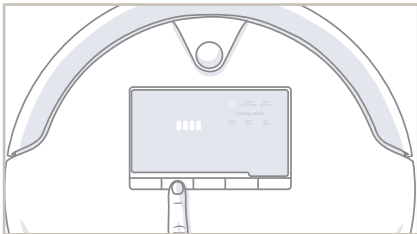

2

Press the GO! button to confirm your selection.

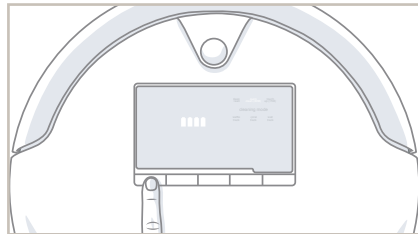

### Deep Clean

- Bob will thoroughly cover a large area for just over an hour

### Quick Clean (30 min)

- Bob will cover a medium-sized area for 30 minutes

### Touch Up (15 min)

- Bob will cover a small area for 15 minutes

### Waffle Track™

- Bob will target a 6' x 5' spill zone by tracing a grid pattern

### Spiral Track™

- Bob will target a 5' x 5' spill zone by spiraling outward from the center and then reversing his movements

### Wall Track™

- Bob will travel along the perimeter of your home



## FullCommand™ Remote

Schedule Bob's cleaning schedule, adjust his speed, and control his movements all from his FullCommand™ remote.

- Go! **1**
- Charge **2**
- Cleaning Mode **3**
- UV Light **4**
- Wake/Sleep **5**
- Mute **6**
- Navigational Buttons **7**
- OK/Sync **8**
- Thorough Lift™ **9**
- Set Current Time **10**
- Set Cleaning Schedule **11**

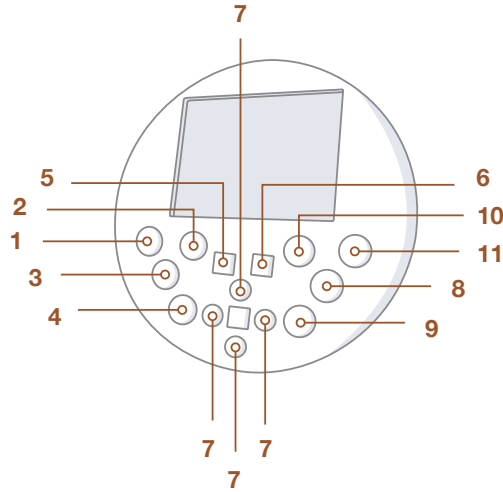

Bob's remote requires 2 AAA batteries (not included). Do not leave the batteries in the remote if you are not using it on a regular basis. Keep the remote at a normal room temperature.

### Go!

- Bob will begin cleaning

### Cleaning Mode

- Cycles through Bob's cleaning modes

### Charge

- Sends Bob to his charging station

### Wake/Sleep

- Puts Bob in standby mode

### UV

- Turns the UV light on and off while Bob is cleaning

### Mute

- Mutes Bob's beeping while he is in standby mode

### Set Current Time

- Sets the current time and date

### Set Cleaning Schedule

- Sets Bob's regular cleaning schedule

While in standby mode, Bob will beep every 2 minutes to let you know that he is not fully powered off. To conserve Bob's battery, flip his power switch OFF, or press the MUTE button on his cover or remote to mute his beeping.

## Syncing Bob's Remote

### OK/Sync

- Confirms time selection/Synchronizes remote

### Thorough Lift™

- Slows Bob down for an intensive clean or speeds him up to his default speed, Turbo Lift™

### Navigational buttons

- Guides Bob forward, backward, right, or left

### Stop

- Pauses or resumes Bob's movements

Hold down the navigational buttons to keep Bob moving in the desired direction.

Bob must be synced to his FullCommand™ remote before he is able to obey its commands.

To sync Bob's remote:

1

Hold down the OK/SYNC button on Bob's remote.

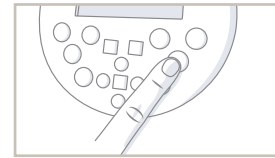

2

While still holding down the OK/SYNC button, flip Bob's power switch ON.

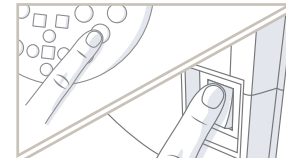

3

Bob will chirp twice to let you know the sync was successful.

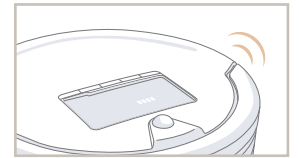

# Cleaning Schedule

## Set Bob's Cleaning Schedule

Bob can be programmed to start cleaning on the dates and times of your choosing through his FullCommand™ remote.

To set up Bob's cleaning schedule, you must first set the current time and date on his remote.

To set the current time and date:



Flip Bob's power switch OFF and back ON.

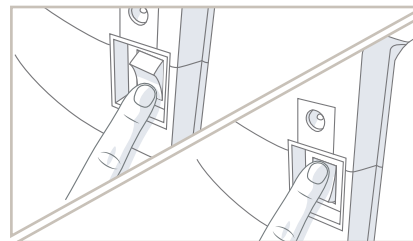

Press the SET CURRENT TIME button.



3

The first hour digit will start flashing. Use the FWD and BACK buttons to adjust the first hour digit.



4

Press the right button to move on to the next digit. Adjust the hour and minute digits using the FWD and BACK buttons.

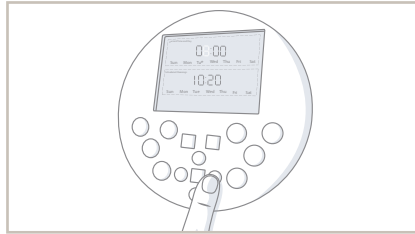

5

Press the right button to move on to days. "Sun" -Sunday- begins blinking. Use the FWD and BACK buttons to select the correct day.

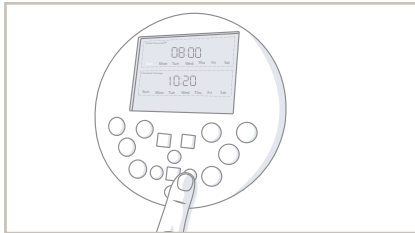

6

When the right day is set, press the SET CURRENT TIME button again to save your settings. Bob will chirp once to let you know the current time is set.

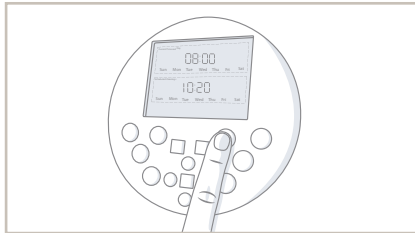

After setting the current time and day on Bob's remote, you may set his cleaning schedule.

To set the cleaning time and day(s):

1

Flip Bob's power switch OFF and back ON.

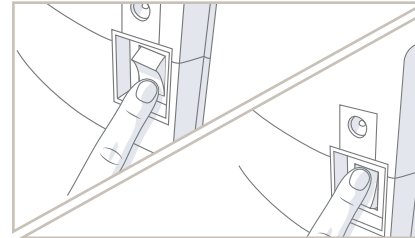

2

Press the SET CLEANING SCHEDULE button.



The remote keeps its programmed schedule for 4 hours after batteries are removed.

3

The first hour digit will start flashing. Use the FWD and BACK buttons to adjust the first hour digit.



4

Press the RIGHT button to move on to the next digit. Adjust the hour and minute digits using the FWD and BACK buttons.



5

To select Bob's cleaning days, press the RIGHT button until "Sun"-Sunday-begins blinking. Use the FWD and BACK buttons to move between the days of the week, and press the OK/SYNC button to select or deselect cleaning for that day.



You can enable cleaning for as many days of the week as you like.

6

When done, press the SET CLEANING SCHEDULE button again to save your settings. Bob will chirp once to let you know the scheduled time is set.

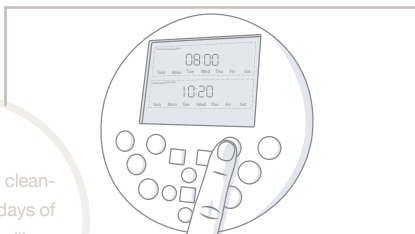

## Auto-Resume

On auto-resume mode, Bob leaves his charging station EVERY TIME his battery is full to perform "back-to-back" cleaning cycles.

To enable auto-resume:

1

Make sure Bob and his FullCommand™ remote are synced. Then flip Bob's power switch ON.

2

Press the SET CLEANING SCHEDULE button on Bob's remote. The first digit under "Scheduled Cleanings" will start flashing.



3

Press the STOP button and “bbgo” - back-to-back go - will appear on the remote’s screen.

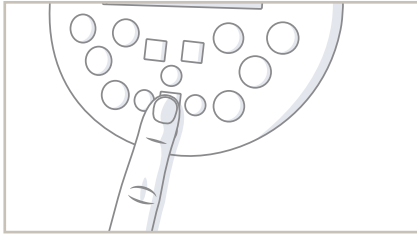

4

Press the SET CLEANING SCHEDULE button again to save your settings.

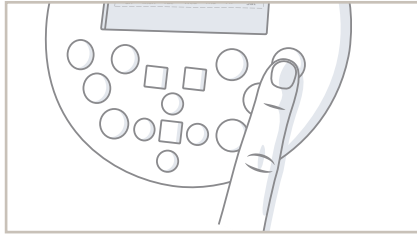

To disable auto-resume:

1

Press the SET CLEANING SCHEDULE button on the remote.

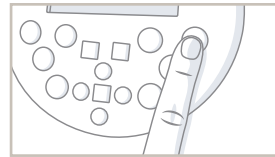

2

Press the STOP button and “bbgo” will reset to the last saved time.

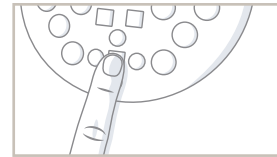

3

Press the SET CLEANING SCHEDULE button again to save your settings.

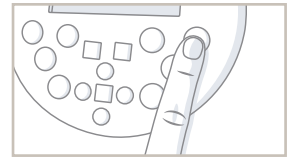

The background features several overlapping circles and patterns. On the left, there is a large blue circle with a dark blue circle on top and a grey circle to its right. Below the blue circle is a white circle with a black dot pattern. To the left of the blue circle is a grey circle with diagonal stripes. At the top left is a white circle with a grey dot pattern. At the top center is a white circle with an orange dot pattern. On the right, there is a large blue circle with a smaller orange and white striped circle overlapping it. Below the blue circle is a solid orange circle overlapping a light blue circle with a fine dot pattern. In the bottom left, there is a white circle with a grey dot pattern. In the bottom right, there is a white circle with a grey dot pattern. The text 'Parts & Maintenance' is centered in the right half of the image.

**Parts  
&  
Maintenance**

## Mop

Bob's microfiber mopping cloth can pick up dirt while both wet and dry.

To use Bob's mop:

1

Align the two prongs of the mop attachment to their corresponding spaces between Bob's left and right wheels.

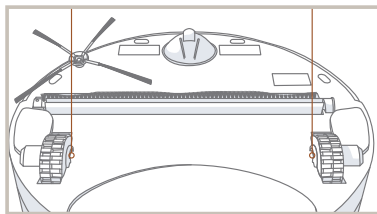

2

Press down on the mop attachment until both sides are secured.

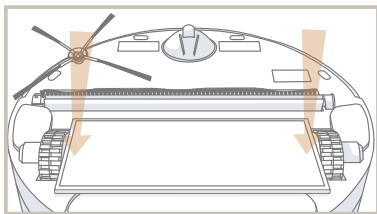

Remove the mop attachment when Bob is cleaning carpets or rugs, or you may use bIOck Plus™ to keep Bob away from carpet while he is mopping.

To uninstall Bob's mop attachment:

1

Lift the mop attachment on the edge that sits atop Bob's dustbin.

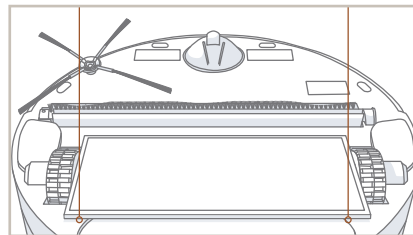

2

Pull up until the mop detaches.

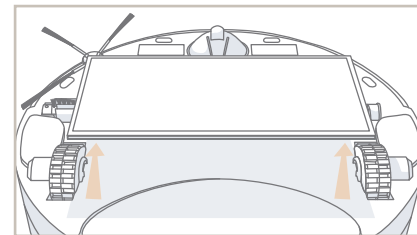

46

You may dampen Bob's mopping cloth with water or cleaning liquid before placing it on his mop attachment.

Bob's microfiber mopping cloth can be washed manually or in the washing machine. A spare cloth is provided in Bob's package.

47



## bIOck Plus™

If you need to keep certain areas out of Bob's reach, you can use bIOck Plus™ to create up to two digital barriers that Bob will not cross. bIOck Plus runs on 4 AA batteries (not included).

One digital barrier is emitted from the left side of bIOck Plus™, and another is emitted from the front. You may use one or both barriers depending on your preference.

As with Bob's charging station and remote, you will need to sync bIOck Plus™ before using it for the first time.

Located on the back of bIOck Plus™, just above the battery cover, are three buttons:

- Power button for the left barrier **1**
- Power button for the front barrier **2**
- SYNC button **3**

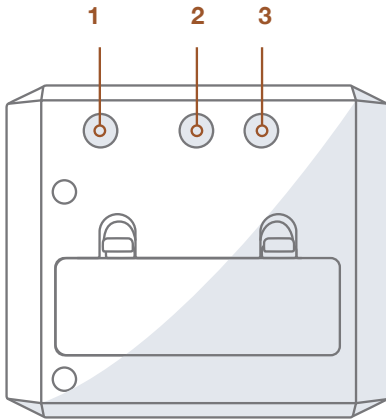

To sync bIOck Plus™:



Press the button on the far left, and the power light on the left side of bIOck Plus will turn on, stay still for 10 seconds, and then slowly blink every 3 seconds.

This means the bIOck's left barrier is ON and ready to sync.

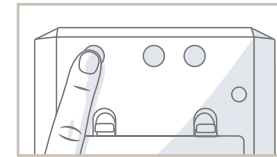

Press the button in the center. Now the power light on the front side of bIOck Plus will turn on, stay still for 10 seconds, and then slowly blink every 3 seconds.

This means the bIOck's front barrier is ON and ready to sync.

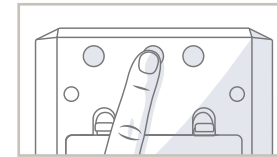

Hold down the bIOck's sync button on the far right **while at the same time** flipping Bob's power switch ON. Bob will chirp twice to let you know the sync was successful.

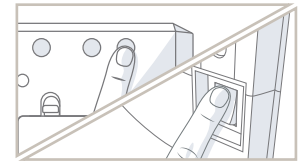

Now that Bob has synced with bIOck Plus™, you may use it to section off areas of your home. You can sync multiple bIOcks with Bob.

To set up digital barriers with bIOck Plus™:

To activate the left barrier:  
Press the power button on the far left.  
The red power light on the left side of bIOck Plus™ will turn on.

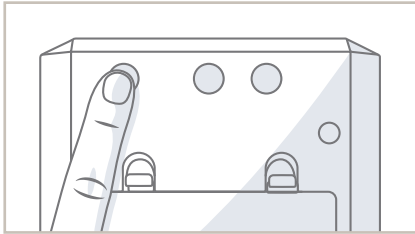

To activate the front barrier:  
Press the power button in the center.  
The red power light on the front side of bIOck Plus™ will turn on.

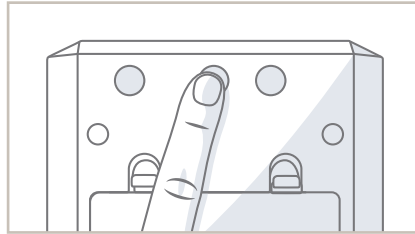

To turn bIOck Plus™ OFF:

To turn the left barrier off:  
Press the power button on the far left.  
The red power light on the left side of bIOck Plus™ will disappear.

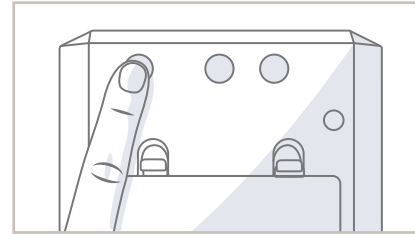

To turn the front barrier off:  
Press the power button in the center.  
The red power light on the front side of bIOck Plus™ will disappear.

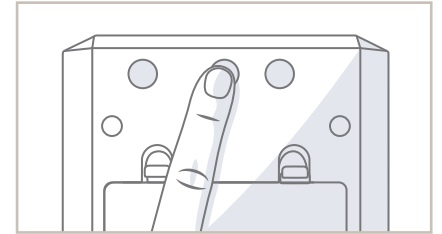

When running low on battery, the bIOck's red power lights will begin to blink rapidly.  
To conserve battery, turn the bIOck OFF when it is not in use.

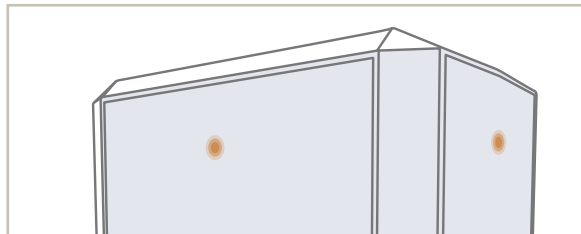

bIOck Plus™ will remain ON for three hours before entering standby mode.

## Dustbin

To empty the dustbin:

1

Push the center black button on Bob's back to release the dustbin and pull.

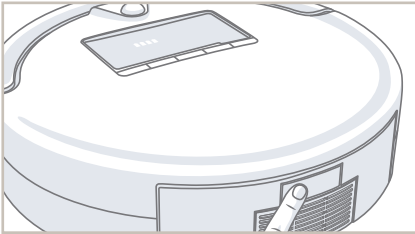

2

Open the transparent gate to empty the bin.

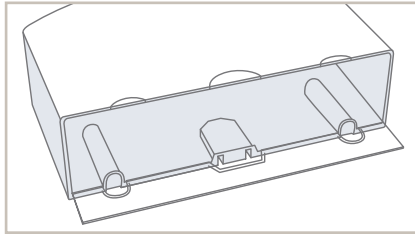

3

You may wipe the dustbin with a dry cloth or brush it with the cleaning tool.

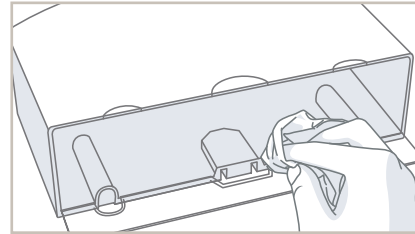

4

When done, replace the transparent gate and slide the dustbin back into Bob.

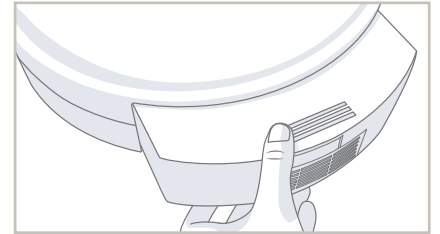

## Filters

Three filters are located inside the dustbin's ceiling. These filters capture fine particles and allergens, and prevent them from escaping the dustbin.

To remove the filters:

1

First eject the dustbin.

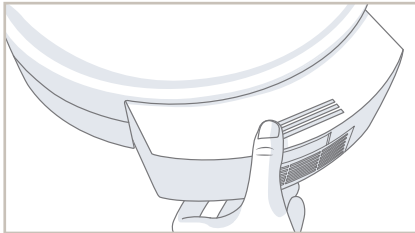

2

Then pull the filter's frame towards you.

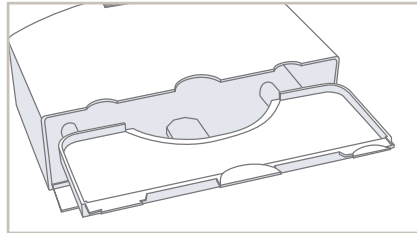

You will see three filter layers:

**Mesh filter 1**  
for larger particles

**Electrostatic filter 2**  
for fine particles

**HEPA filter 3**  
for sub-micron particles

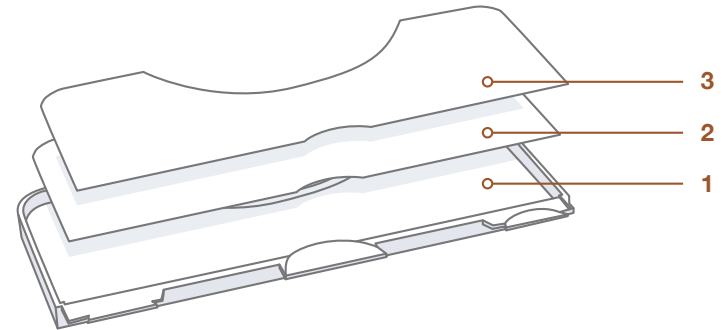

Use the cleaning tool to brush dust off the filters. It is recommended that you change Bob's filters every 6 months, depending on the frequency and intensity of his cleaning.

## Main Brush

It is recommended that you remove and clean Bob's main brush on a weekly basis.

To do so:

1

Remove the screw securing Bob's main brush using a flat head screwdriver.

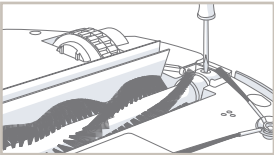

2

Use the cleaning tool to remove hair and debris from both ends of the brush as well as the compartment inside Bob.

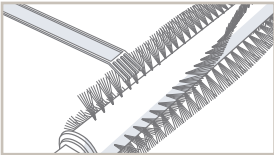

3

You may use a pair of scissors to cut away any hair or threads wrapped around the brush, or a pair of tweezers to remove congestion from the notches where the main brush is held.

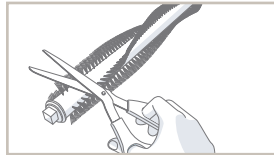

To reinstall the brush:

1

Replace the end piece and insert the opposite end of the brush into the square indentation inside Bob.

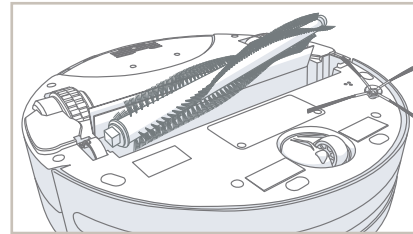

2

Lastly, re-tighten the screw.

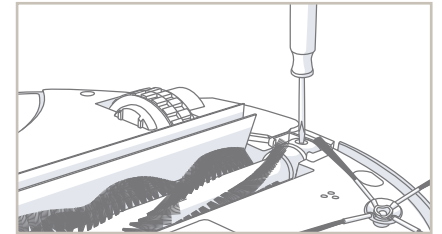

## Side Brush

Bob's side brush extends his reach and allows him to sweep along corners and walls. When Bob is first delivered to you, his side brush is not installed.

### To do so:

Use the flat head screwdriver and short screw included in Bob's box to secure the side brush into the empty socket on Bob's underside.

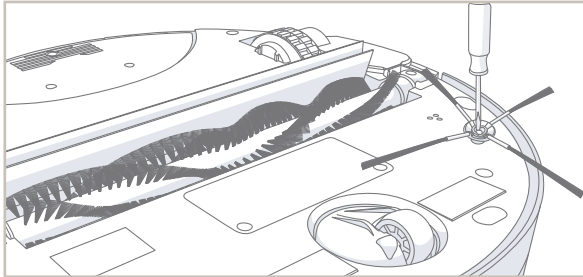

It is recommended that you remove and clean Bob's side brush on a weekly basis.

### To do so:

1

Remove the side brush using a flat head screwdriver.

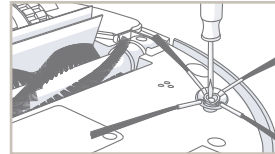

2

Use the cleaning tool to brush off hair tangled around the side brush as well as the socket where the side brush is held.

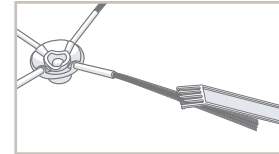

3

Replace the side brush and re-tighten the screw.

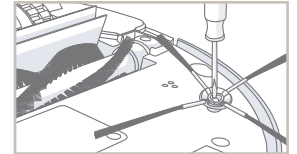

## Battery

### Replacing Bob's Battery

1

Remove the battery cover on Bob's underside using a Phillips head screwdriver.

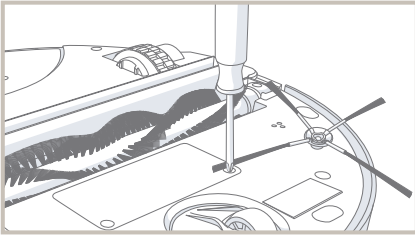

2

Lift the battery out of its compartment, and unplug the connecting wires.

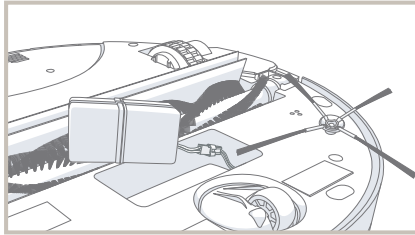

3

Plug the new battery in and slide it into the empty compartment.

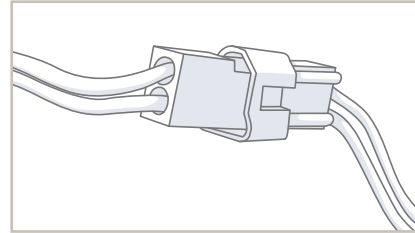

4

Re-tighten the screws on the battery cover.

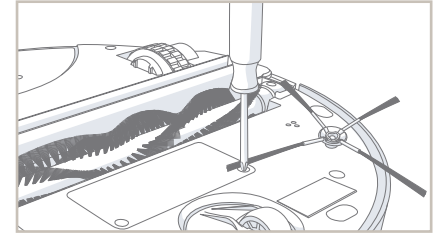

### Storing Bob

If you are not using Bob for an extended period of time, unplug his charging station, remove his battery, and store everything in a dry place at room temperature.

Do not let Bob sit idly with his power switch ON for more than a week; switch him OFF to conserve his battery.

Do not leave Bob in direct sunlight.

Dirt and dust on Bob's wall and edge sensors can reduce his performance. Regularly cleaning these sensors ensures that Bob keeps working at his best.

**To do so:**

Use a soft cloth slightly moistened with cold water or alcohol to wipe the wall sensors along Bob's bumper and the oval-shaped edge sensors on his underside.

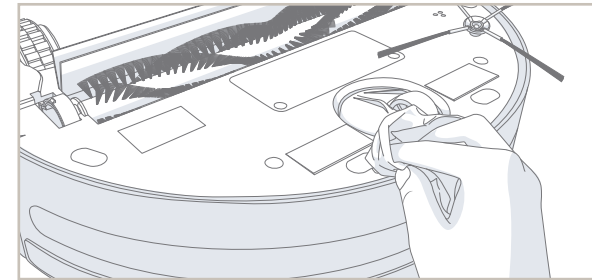

# Sensors



## Deactivate Edge Sensors

Dark-colored carpeting and certain floor patterns may seem like edges to Bob's edge sensors.

If you notice that Bob stops working on your carpet and displays that he feels "something funny going on" with his edge sensors, then you may need to temporarily deactivate them.

To deactivate Bob's edge sensors:

1

Flip Bob's power switch ON. Hold down the CHECKUP button on Bob's cover. The 4 bars above "Check Up" will begin to flash on Bob's screen.

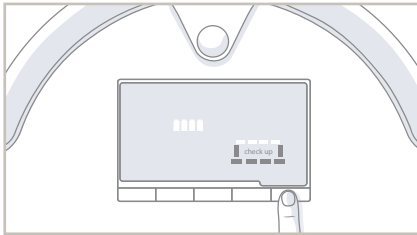

2

After the 4 bars flash 7 times and remain still, release the CHECKUP button. The 4 bars above "Check Up" will remain on. This means Bob's edge sensors are deactivated.

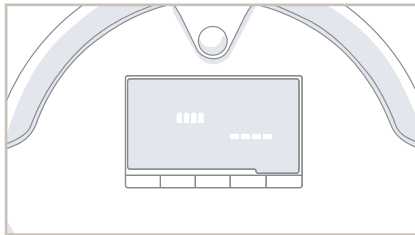

Caution: When the edge sensors have been deactivated, Bob will be unable to detect stairs or sharp drops.

To reactivate Bob's edge sensors:

1

Hold down the CHECKUP button on Bob's cover. The 4 bars above "Check Up" will begin to flash on Bob's screen.

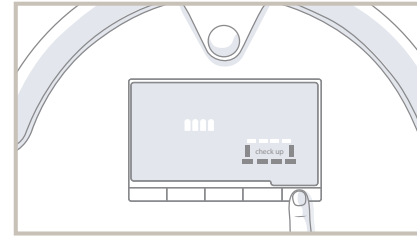

2

After the 4 bars stop flashing and disappear, release the CHECKUP button. Bob's edge sensors are active again.

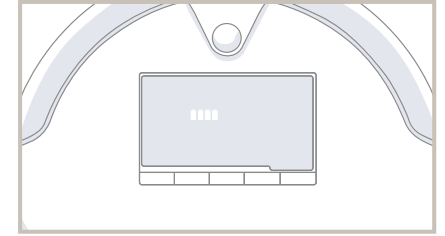

The background features several overlapping circles and patterns. On the left, there is a large blue circle with a dark blue circle on top and a grey circle on the right. Below the blue circle is a white circle with a black dot pattern. To the left of the blue circle is a grey circle with diagonal stripes. At the top left is a white circle with a grey dot pattern. At the top center is a white circle with an orange dot pattern. On the right, there is a large blue circle with a smaller orange circle with diagonal stripes overlapping it. Below these is a large orange circle with a grey circle overlapping its right side. At the bottom left is a white circle with a grey dot pattern. In the bottom left corner, there are two thin, concentric white circles. The text 'Troubleshooting & Home Checkup Test' is centered on the right side, enclosed within a thin white double-line circle.

# Troubleshooting & Home Checkup Test

## Troubleshooting

When Bob is experiencing some difficulty, he will notify you by displaying on his screen “*Oops! I feel there’s something funny going on with my:*” along with the name of the part having an issue.

If after attempting the suggested solutions Bob’s problem persists, you may want to perform a home checkup test on him (see next section). You may also contact our customer care center at [support@bobsweep.com](mailto:support@bobsweep.com).

Not a fan of reading? Visit [owners.bobsweep.com](https://owners.bobsweep.com) for handy video guides, or scan this QR code:



## Oops! I feel there’s something funny going on with my:

### Edge Sensors

The edge sensors are blocked or dirty. Bob’s four, oval-shaped edge sensors are located on his underside, near his bumper.

#### What to do:

Clean the sensors using a clean, dry cloth or compressed air.

If Bob is continually having trouble with his edge sensors while working on dark-colored carpeting, you may need to deactivate them.

#### To deactivate Bob’s edge sensors:

Hold down the CHECKUP button on Bob’s cover. The 4 bars above “Check Up” will begin to flash on Bob’s screen. After the bars flash 7 times and remain still, release the CHECKUP button. [Refer to page 61]

### Touch Sensors

There is a small piece of debris trapped underneath Bob’s bumper that is interfering with his touch sensors.

#### What to do:

- Slowly and carefully tap on Bob’s bumper to force the obstacle out.
- Use compressed air to clear out dust and debris trapped underneath the bumper.

Press the corner ends of the bumper until you hear a tiny “click” sound. If the bumper is not clicking on its ends, the touch sensors may need to be replaced.

### Left Wheel

Something is blocking the left wheel.

#### What to do:

Use the cleaning tool or compressed air to remove any dust or debris that may be jamming the left wheel.

### Main Brush

The main brush is unable to move freely.

#### What to do:

- Remove the main brush using a flat head screwdriver, and clean it thoroughly from end to end.
- You may use a pair of scissors to cut hair or thread wrapped around Bob's brush, or a pair of tweezers to remove congestion from the square metal indentation where the main brush is held.



If Bob has trouble cleaning on shag carpet or rug, you may remove his main brush and allow him to vacuum without it.

### Wall Sensors

The wall sensors are blocked or dirty.

#### What to do:

- Do a visual check of the transparent stripe on Bob's bumper. If it is too dirty for you to see what is behind it, wipe it with a clean, damp cloth.
- To ensure nothing is jammed under the bumper, gently tap it and use compressed air to clear it of debris.

### Dustbin

Bob's dustbin is not properly installed, or the metal contact points on the dustbin's bottom are dirty.

#### What to do:

- Remove Bob's dustbin and empty it.
- Turn the dustbin around and gently wipe the two metal connectors on its bottom.
- Lastly, clean the metal contact points in the space inside Bob where the dustbin is inserted.

### Right Wheel

Something is blocking the right wheel.

#### What to do:

Use the cleaning tool or compressed air to remove any dust or debris that may be jamming the right wheel.

### Power System

Bob's battery is disconnected or has absolutely no juice left.

#### What to do:

Check Bob's battery connection.  
Place Bob directly onto his charging station and allow him to charge for a few hours.

If this fails to wake him, then Bob may need a new charging station.

#### What to do:

Unplug the charging station and plug the adapter directly into the inlet on Bob's side. Allow him to charge for a few hours.

If connecting the charging adapter to Bob fails to wake him, he likely needs a new one.

If Bob is not performing as well as he used to, you can diagnose the problem with a simple home checkup test.

If Bob fails any part of the checkup test, he may need a replacement part. In this case, please call our customer care center at [1-888-549-8847](tel:1-888-549-8847) for toll-free support in the US and Canada, or email us at [support@bobsweep.com](mailto:support@bobsweep.com).

### Put Bob in Checkup Mode



Flip Bob's power switch OFF.

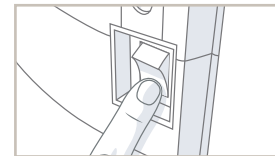

While holding down the CHECKUP button on Bob's cover, turn Bob's power switch ON.

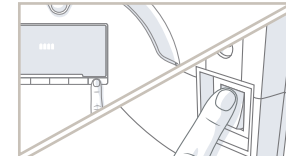

Bob will chirp three times to let you know he is now in checkup mode. You may release the CHECKUP button. Do not press any additional buttons.

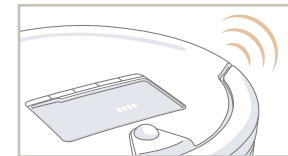

While in checkup mode, the word "bObsweep" will flash on Bob's screen.

### Step One: Edge Sensors

The 4 bars above the word “Check Up” should be lit on Bob’s display.

Lift Bob about 6 inches (15 cm) off the ground. You should see the 4 bars turn off.

If all 4 bars turn off while Bob is lifted, place Bob back on the floor and continue on to the next step without pressing any additional buttons.

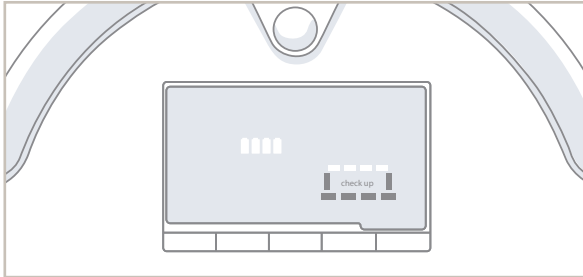

### Step Two: Wall Sensors

Use a thick, flat, and white surface to imitate a wall and drag it around Bob’s bumper.

The 5 bars below the word “Check Up” should light up one at a time as you move your imitation wall around Bob’s bumper.

If all 5 bars light up, you may move on to the next step of the checkup test. Do not press any additional buttons.

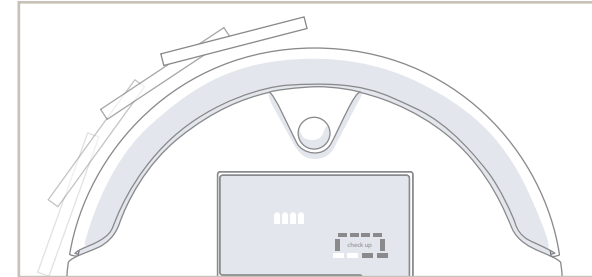

### Step Three: Touch Sensors

Press the left side of Bob's bumper and the bar to the left of the word "Check Up" should light up; press the right side of the bumper and the bar to the right of "Check Up" should light up.

Press the center of the bumper and both bars on either side of the word "Check Up" should light up at the same time.

If both bars light up correctly, you may move on to the next step of the checkup test.

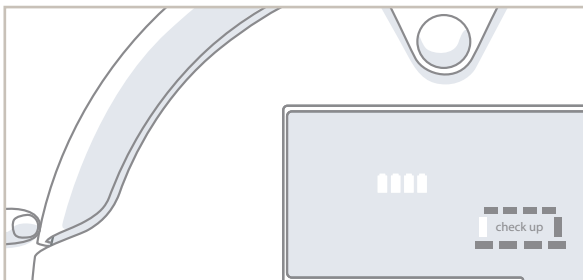

### Step Four: Charging Station

The charging station must be synced and plugged in for this step of the checkup test. Next, press the GO! button on Bob's cover.

Place Bob directly in front of his charging station, about 1 ft away. Keep bLock Plus away from Bob so its signal does not interfere with the test.

The words "Deep Clean," "Quick Clean," and "Touch Up" should be lit on Bob's display.



"Deep Clean" and "Touch Up" represent the station's sensors. If either one of them fails to light up, then there is likely something wrong with Bob's charging station.

The word "Quick Clean" represents the signal on Bob's front. If it fails to light up, then it is likely Bob needs a new bumper transmitter.

If all three words light up correctly, you may move on to the next step of the checkup test.

### Step Five: bLOck Plus™

bLOck Plus™ must be synced and turned ON for this step of the checkup test. Unplug the charging station so its signal does not interfere with this test.

Place bLOck Plus™ with its digital beam directly facing Bob's front. bLOck Plus emits a digital boundary from both its front and left sides. Test both boundaries to ensure that they are working properly. The word "Deep Clean" should light up when it senses a signal from either side of bLOck Plus.

If Bob responds to bLOck Plus's signals, you may move on to the next step of the test.

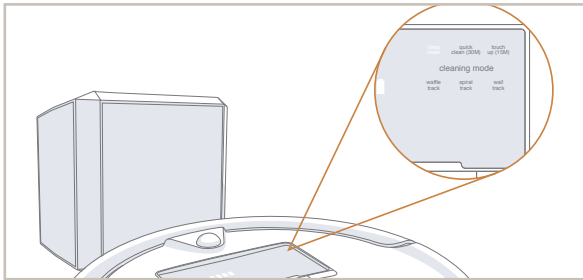

### Step Six: Display Screen

Press the GO! button on Bob's cover once more. Each icon on Bob's screen will light up in a repeating rotation.

Once the cycle has finished, you may move on to the next step of the checkup test.

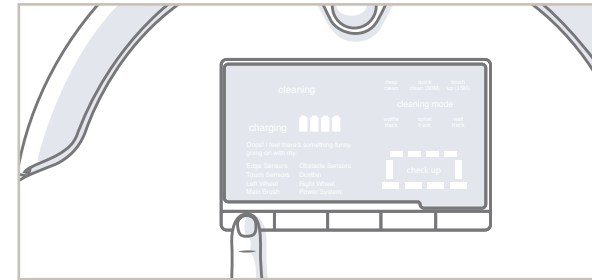



### Step Seven: Brush and Suction Power

Press the CLEANING MODE button on Bob's cover.

Both the side brush and the main brush should start rotating and you should feel air flowing from the back of the dustbin.

If Bob's main brush is having difficulty moving, Bob will let you know by indicating on his screen that there is "something funny going on" with his main brush.

If Bob's vacuum motor is behaving oddly or if his dustbin has been removed, he will indicate that there's "something funny going on" with his dustbin.

Move on to the next step of the checkup test if all parts are working properly.

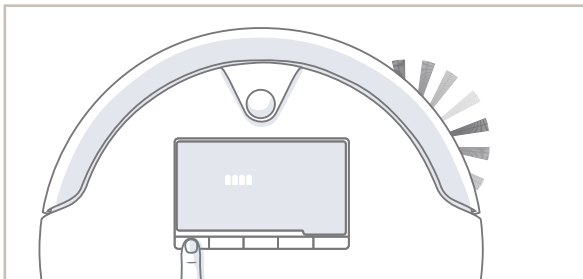

### Step Eight: UV Light and Wheels

Lift Bob off the floor to keep him from running away! Next, press the CHARGE button and his wheels should drive forward.

Flip Bob over and you should see his UV lamp lit. Do not look directly into the UV lamp.

Press the CHARGE button once more. Bob's wheels should drive backwards and his UV lamp should turn off.

If Bob is having difficulty rotating either one of his wheels, he will indicate on his screen that there is "something funny going on" with either one of them.

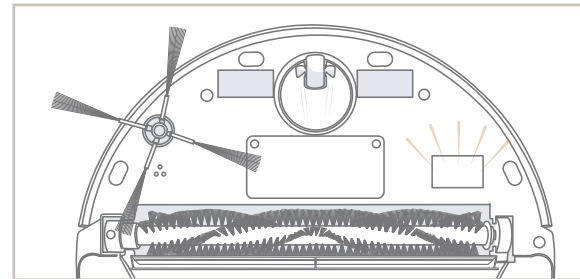

## Warranty Information

If Bob completes the checkup test without any issues, then his internal parts are working properly! Contact [support@bobsweep.com](mailto:support@bobsweep.com) if you have any questions, as our doctors at the bObsweep hospital are always ready to help!

Every bObsweep PetHair Plus purchased from an authorized seller and used anywhere in the world includes a 2-year limited warranty, 5 years of subsidized visits to the bObsweep hospital, and a lifetime of customer support. The warranty covers the battery and all labor and parts, except consumables like brushes, filters, and mopping cloths. Postal charges are not covered by the warranty.

Additional coverage plans are available for purchase at <http://www.bobsweep.com/coverageplan>.

Even after Bob's 2-year warranty is over, replacement parts and visits to the bObsweep hospital are subsidized between 25% – 50% for 5 years from the date he was first purchased.

To activate Bob's warranty, keep your original receipt and register him online at <http://www.bobsweep.com/warranties>.

## Bob's Cleaning Behavior

Bob's cleaning pattern may look quite different from the way a human would clean: he may spin in a gradually widening circle, follow along walls, or zigzag across a small area. Sometimes he may seem to be ignoring some spaces or spending too much time on others — but don't worry! Bob's dirt sensors tell him to pay more attention to particularly dusty or soiled areas. Rest assured, Bob will efficiently clean your home within the course of a full cycle — just check his dustbin for the evidence!

It is best to let Bob work in his own way, even if his movements appear odd. Moving him around, manipulating his movements, or picking him up may confuse him and disrupt his cycle.

If you wish to control Bob's movements manually, you may use the navigational buttons on his FullCommand™ remote. If your rooms are divided by higher ledges than Bob is able to climb, you may block off the area using bLOck Plus™.

## Bob's Challenges

### Unique Furniture

Bob is designed to maneuver around furniture of most shapes and sizes, but certain configurations may confuse him temporarily. Bob may sometimes find it difficult to clean under chairs with narrow legs, or furniture that is too low for his bumper sensors to detect. Specialty furniture, such as desk chairs with wheels or stools with circular bases, may also confuse him for a moment — but don't worry, Bob usually finds his way around with time.

### Edge Sensors

Bob uses infrared light to detect edges and stairs; because dark-colored carpet absorbs most light, it may seem like an edge to Bob's sensors. If Bob indicates on his screen that there is "something funny going on" with his edge sensors, you may need to temporarily deactivate them. To do so, simply hold down the CHECKUP button on Bob's cover until the 4 bars above "Check Up" flash 7 times and remain lit on his screen [refer to page 61]. Just remember that while Bob's sensors are deactivated, he will not be able to detect edges or stairs!

### Main Brush

Bob's main brush, which is designed to reach deep into carpet, may also have trouble turning on rugs with long fibers or fringes. You may tuck fringes underneath rugs or remove Bob's main brush and see how he performs without it.

### Wet/Dry Mop

Bob's wet/dry mop, which is attached to his bottom, is designed to sit flat against the floor and leave behind a sparkling trail. Because of this, Bob may have a tough time climbing over elevated surfaces while mopping. Make sure to remove Bob's mop when he is not cleaning smooth surfaces such as tile or hardwood.

### Inclines

Sometimes Bob will attempt to drive up angled surfaces, getting stuck for a few minutes before deciding to clean somewhere else. This is because Bob wants to cover every spot in your home and will try his hardest to overcome any obstacle!

As long as Bob does not indicate on his screen that there is a problem, let him find his own way around your home and continue cleaning. Take note of the areas Bob finds the most challenging, and if possible spread or adjust some of your furniture accordingly.

### The Solution: bLOck Plus™

If Bob finds a part of your home challenging to clean, use bLOck Plus™ to keep him away. bLOck Plus™ emits 2 digital boundaries: one from its left side, and the other from its front. You may use one or both, depending on your preference. Refer to page 46 of this manual for detailed instructions on how to sync and use bLOck Plus™.

## FAQs

### 1. Where can I find Bob's how-to videos?

Bob's "training" videos can be found at Bob's Owners' Corner: <http://owners.bobsweep.com>.

### 2. How long should Bob's battery last?

The exact time depends on the type of surface Bob is cleaning as well as the age of the battery. Generally, the smoother the surface (hardwood or tile, for example), the longer the battery will last. When fully charged, a brand new Bob usually cleans for just over an hour.

### 3. How do I know that my Bob has fully charged and is ready to clean?

When Bob charges using the adapter or charging station, the battery bars on his display screen flash and the word "Charging" lights up. When Bob has fully charged, the battery bars remain still and the word "Charging" disappears.

### 4. How often should I empty the dustbin?

Bob's dustbin has a 1L capacity — three times larger than most robotic vacuum cleaners on the market today! This means you may not need to empty the dustbin immediately after every cleaning. Depending on the size of the room and the amount of particles piled up, Bob can complete approximately six cleaning cycles before he fills his dustbin. Simply remove the dustbin and check to see if emptying is necessary.

### 5. How often should I clean Bob's brushes?

Bob's brushes do a lot of the work picking up hair and debris, so it is recommended that you clean the main and side brushes weekly if you are using Bob regularly. To thoroughly clean the brushes, remove them using a flat head screwdriver. Remember to clean the notches in Bob's interior that hold his brushes in place. This ensures the brushes stay in peak condition for a long time.

#### 6. My Bob won't turn on no matter what I do.

If Bob does not start after flipping his power switch ON, his battery has likely drained too low to operate. To recharge him, place him directly onto his charging station with the metal plates on his underside lined up with the nodes on his station. Let Bob recharge fully before asking him to clean again. When Bob charges, the battery bars on his display screen flash and the word "Charging" lights up. When Bob has fully charged, the battery bars remain still and the word "Charging" disappears.

#### 7. Why is Bob beeping?

Bob beeps once every 2 minutes when he is on standby mode. To conserve battery, turn his power switch OFF. You may also mute Bob's beeping by pressing the MUTE button on his cover or FullCommand™ remote.

Bob also beeps when he encounters a problem cleaning and needs assistance. In this instance, he will also identify the source of the issue directly on his screen. Consult the Troubleshooting section of this manual to see what to do when Bob is having trouble with one of his parts.

#### 8. Bob is having trouble finding his charging station. Where is the best place to put his station?

Bob will find his station more easily if you place it in a central location with plenty of space around it, so that he may detect it from afar. In order for Bob to dock properly, be sure to place the charging station against a wall on a flat, level surface.

#### 9. I am having problems removing Bob's brush.

If the main or side brushes are difficult to remove, it is likely because hair, string, and/or other debris have been caught in them and are clogging the areas where they attach to Bob. It is best to clean Bob's brushes about once a week to prevent buildup. You can use scissors to cut away hair wrapped around the brushes until you are able to remove them. You may need to gently pull the main brush up or down to reach the corners, but do not force the brush out as this can damage it.

#### 10. Bob gets stuck under my furniture or travels over wires that tangle up his brush. How can I stop him from going into these areas?

If Bob maneuvers under a piece of furniture and there is only one open entrance, he may need a few minutes to figure out how to escape on his own. You will not need to assist him when this happens, unless Bob stops cleaning completely and starts beeping.

If you would like Bob to avoid a certain area, such as an area with lots of wires, you may use bLOck Plus to create one or two digital boundaries.

### 11. Why does Bob start up when I did not tell him to clean?

Bob will start up on his own when he is scheduled to clean, or when his auto-resume feature is enabled. Bob's weekly cleaning schedule is displayed on his FullCommand™ remote. Bob will automatically start cleaning on the time and days of the week visible below "Scheduled Cleanings." Bob works on a 24 hour clock, so if he is scheduled to clean at 01:00, then he will begin working at 1 am; if he is scheduled to clean at 13:00, then he will begin working at 1 pm. To reset Bob's schedule, press the SET CLEANING SCHEDULE button on his remote and input the time of your choosing.

When Bob is on auto-resume mode, the word "bbgo" is visible on his FullCommand™ remote, below "Scheduled Cleanings." This means Bob will automatically begin cleaning after he has fully charged. To disable auto-resume, press the SET CLEANING SCHEDULE button on Bob's remote. Then press STOP. "bbgo" will reset to the last time saved. Press SET CLEANING SCHEDULE again to save your settings.

### 12. When should I use the different cleaning modes?

Deep Clean is Bob's default mode and gives him enough time to thoroughly cover a large area. If you would like to clean a smaller area, you may use Quick Clean mode, which lasts 30 minutes, or Touch Up mode, which lasts 15 minutes.

Waffle Track and Spiral Track are best used when cleaning a small spill. When Waffle Track is selected, Bob travels in a grid pattern; when Spiral Track is selected, Bob travels in a gradually widening circle. Select Wall Track to make Bob travel along the edges of your room.

### 13. Bob is telling me there's "something funny going on" with one of his parts. How can I fix this?

Bob notifies you directly on his screen the specific reason his work has been interrupted. This intelligent, self-scanning feature allows you to identify the source of the problem quickly. If "something funny" is going on with one of Bob's parts, the problem can usually be solved with simple procedures. Consult the Troubleshooting section of this manual to see the most probable solutions.

### 14. What is the best way to clean Bob's wheels?

Use the cleaning tool or compressed air to clear the creases of the wheels. For a more thorough clean, wipe the sides and bottoms of the wheels as they spin during checkup mode (see the Home Checkup Test section of this manual).

### 15. My Bob just stopped cleaning and his screen turned off. What do I do next?

Like other electronic devices with a CPU (computers, smartphones, etc.), Bob may experience a momentary halt in his operating system. You can usually get Bob back to work by simply turning his power switch OFF and ON again. If this does not solve the issue, Bob might need a manual restart. You can restart him by flipping his power switch OFF and plugging the charging adapter directly into the inlet on his side. Leave him to charge for at least 2 hours to fully refresh his system.

### 16. I have a question and need to contact Bob's support team. How do I do that?

Our devoted team is always eager to help you! You can reach us by phone or e-mail. Call us toll free **1-888-549-8847** for support in Canada and the United States, or e-mail us at [support@bobsweep.com](mailto:support@bobsweep.com). Our goal is to get back to you within a day.

To watch Bob's how-to, repair, and troubleshooting videos; order parts; and connect with your extended bObsweep family members, visit <http://owners.bobsweep.com>.

bOb sweep