

USE AND CARE GUIDE

6-LIGHT CHANDELIER

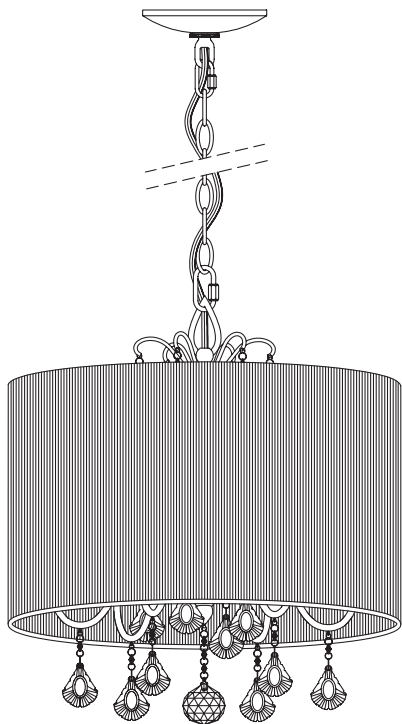

Questions, problems, missing parts? Before returning to the store,
call Home Decorators Collection Customer Service
8 a.m. - 7 p.m., EST, Monday - Friday, 9 a.m. - 6 p.m., EST, Saturday

1-800-986-3460

WWW.HOMEDEPOT.COM/HOMEDECORATORS

THANK YOU

We appreciate the trust and confidence you have placed in Home Decorators Collection through the purchase of this 6-Light Chandelier. We strive to continually create quality products designed to enhance your home. Visit us online to see our full line of products available for your home improvement needs. Thank you for choosing Home Decorators Collection!

Table of Contents

Table of Contents.....	2	Hardware Included.....	3
Safety Information.....	2	Package Contents.....	4
Warranty.....	2	Installation.....	5
Pre-Installation.....	3	Care and Cleaning.....	8
Planning Installation	3	Troubleshooting.....	8
Tools Required.....	3		

Safety Information

- ❑ Read all instructions before assembling and installing the product.
- ❑ Consult a qualified electrician for installation of this fixture.
- ❑ If you have any non-electrical questions about this fixture, please contact our Customer Service Team at 1-800-986-3460 or visit WWW.HOMEDEPOT.COM/HOMEDECORATORS.
- ❑ Save these instructions for future reference.

 **DANGER:** Risk of electrical shock. Disconnect power before installation.

 **IMPORTANT:** Inspect the wire insulation for any cuts, abrasions, or exposed copper that may have occurred during shipping. If there is a defect in the wire, do not continue the assembly process. Please call our Customer Service Team at 1-800-986-3460.

Warranty

LIMITED WARRANTY

WHAT IS COVERED

The manufacturer warrants this lighting fixture to be free from defects in materials and workmanship for a period of five (5) years from date of purchase. This warranty applies only to the original consumer purchaser and only to products used in normal use and service. If this product is found to be defective, the manufacturer's only obligation, and your exclusive remedy, is the repair or replacement of the product at the manufacturer's discretion, provided that the product has not been damaged through misuse, abuse, accident, modification, alteration, neglect, or mishandling.

WHAT IS NOT COVERED

This warranty shall not apply to any product that is found to have been improperly installed, set-up, or used in any way not in accordance with the instructions supplied with the product. This warranty shall not apply to a failure of the product as a result of an accident, misuse, abuse, negligence, alteration, faulty installation, or any other failure not relating to faulty material or workmanship. This warranty shall not apply to the finish on any portion of the product, such as surface discoloration and/or weathering, as this is considered normal wear and tear. The manufacturer does not warrant and specifically disclaims any warranty, whether express or implied, of fitness for a particular purpose, other than the warranty contained herein. The manufacturer specifically disclaims any liability and shall not be liable for any consequential or incidental loss or damage, including but not limited to any labor/expense costs involved in the replacement or repair of said product.

Contact Customer Care at 1-800-986-3460 or visit WWW.HOMEDEPOT.COM/HOMEDECORATORS.

Pre-Installation

PLANNING INSTALLATION

Read all instructions before assembly and installation of product. To avoid damaging this product, assemble it on a soft, non-abrasive surface, such as carpet or cardboard. Inspect each part for defects that may have occurred during shipping. Keep your receipt and these instructions for proof of purchase.

TOOLS REQUIRED



Safety goggles

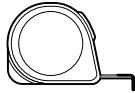

Measuring tape

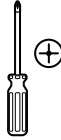

Phillips screwdriver

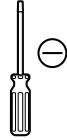

Flathead screwdriver



Wire strippers



Wire cutters



Ladder



Electrical tape



Pliers

HARDWARE INCLUDED



NOTE: Hardware not shown to actual size.



AA



BB



CC



DD



EE



FF



GG



HH



II



JJ



KK



LL



MM



NN

Part	Description	Quantity
AA	Wire Nut	3
BB	Single Crossbar	1
CC	Hex Nut	1
DD	Outlet Box Screw	2
EE	Green Ground Screw	1
FF	Nipple	1
GG	Small Chain Link	1

Part	Description	Quantity
HH	Canopy	1
II	Canopy Loop	1
JJ	Loop Ring	1
KK	Chain	1
LL	Candle Sleeve	6
MM	Tooth Washer	1
NN	Big Chain Link	1

Pre-Installation (continued)

PACKAGE CONTENTS

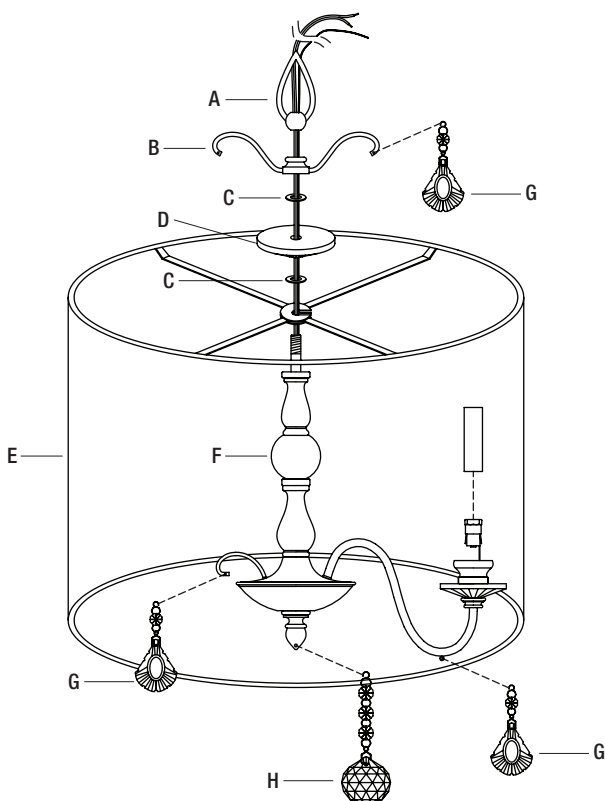

Part	Description	Quantity
A	Fixture Loop	1
B	Top Arm	1
C	Washer	2
D	Crystal Bobeche	1
E	String Shade	1
F	Fixture Body	1
G	Crystal Strand G	18
H	Crystal Strand H	1

1 Assembling the fixture body

- Pull the fixture wire and ground wire up through the Washers (C), Crystal Bobeche (D), Top Arm (B), and the Fixture Loop (A).
- Insert the String Shade (E) between the bottom Washer (C) and the Fixture Body (F), as illustrated.
- Fasten the Fixture Loop (A) to the nipple of the Fixture Body (F).

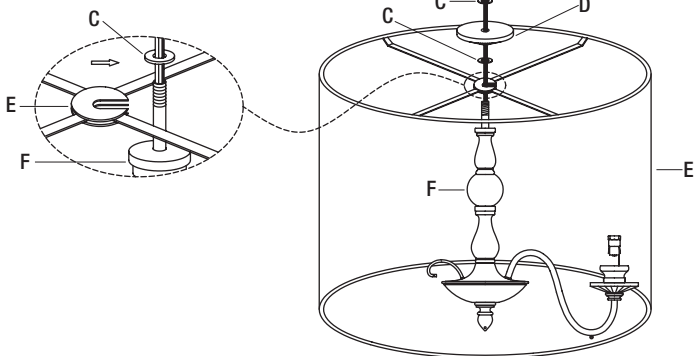

2 Installing the single crossbar



WARNING: Turn the power off at the main fuse box before installation.

- Thread the Nipple (FF) into the Single Crossbar (BB) and secure with a Tooth Washer (MM) and Hex Nut (CC). Adjust the length of the Nipple (FF) if necessary.
- Attach the Single Crossbar (BB) to the junction box (not included) with the two Outlet Box Screws (DD) provided.

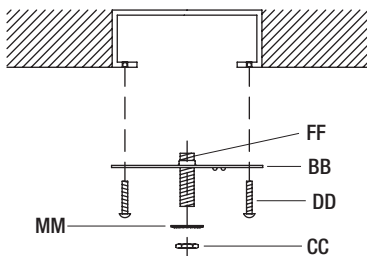

3 Adjusting the chain length

- Shorten the Chain (KK) length to desired hanging length by using pliers (not included) to pull open the chain link at each end of the section of Chain (KK) to be removed.
- Unlink each end of the unwanted section from the Chain (KK) by unhooking the opened link from the remaining Chain (KK).
- Use pliers (not included) to reclose the opened chain link.



NOTE: If adjusting the Chain (KK) length, consider using a soft cloth between the pliers and the Chain links to avoid damaging the finish of the Chain (KK).

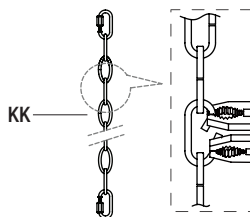

4 Attaching the chain

- Attach the Canopy Loop (II) to the Nipple (FF).
- Pass the Chain (KK) through the Canopy (HH) and the Loop Ring (JJ).
- Attach one end of the Chain (KK) to the Canopy Loop (II) using the Small Chain Link (GG).
- Attach other end of the Chain (KK) to the Fixture Loop (A) using the Big Chain Link (NN).
- Pull the fixture wire and ground wire up from the Fixture Loop (A), through the Big Chain Link (NN), through alternating links on the Chain (KK), through the Loop Ring (JJ), Canopy (HH), Small Chain Link (GG), Canopy Loop (II), and the Nipple (FF) into the outlet box.

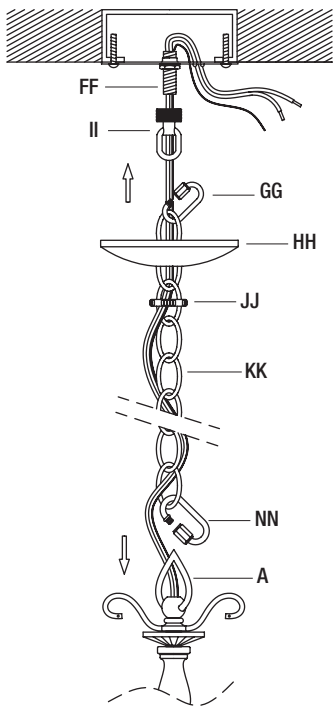

5 Making the electrical connections and locking the canopy

NOTE: Always use Wire Nuts (AA) to connect wires and push all excess wires and connections back into the junction box.

- Connect the ground wire from the branch circuit to the Green Ground Screw (EE) on the Single Crossbar (BB).

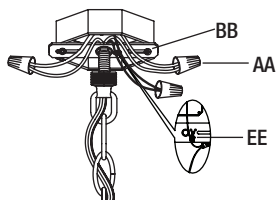

- Connect the fixture wires as follows:

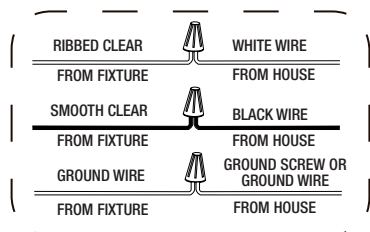

- Cover the three connections using the three Wire Nuts (AA). Wrap the three wire connections with electrical tape for a more secure connection.
- Move the Canopy (HH) up and over the outlet box (not included), and secure the canopy in place by tightening the Loop Ring (JJ) onto the Canopy Loop (II).

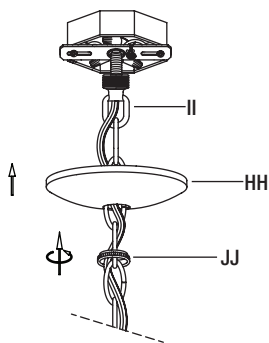

6 Installing the bulbs

- Insert the Candle Sleeves (LL) onto each socket of the Fixture Body (F).
- Install the 60W max CA10 E12 Bulbs (not included) into each socket of the Fixture Body (F).

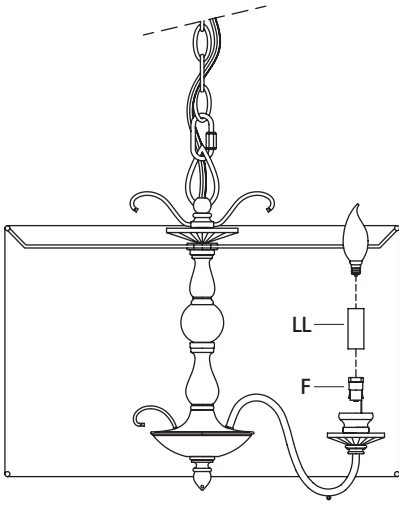

7 Attaching the crystal strands

- Referring to the crystal strands distribution diagram, carefully attach the Crystal Strands (G & H) to the hooks and holes found on the Top Arm (B) and the Fixture Body (F), as indicated.

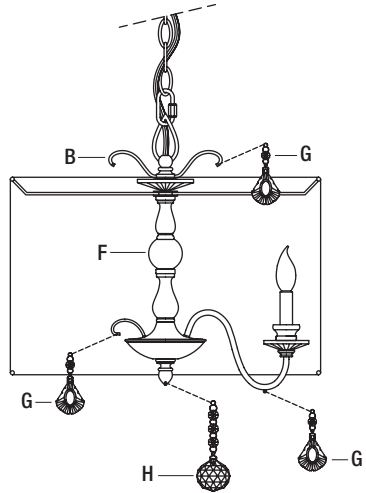

Crystal Strands Distribution Diagram

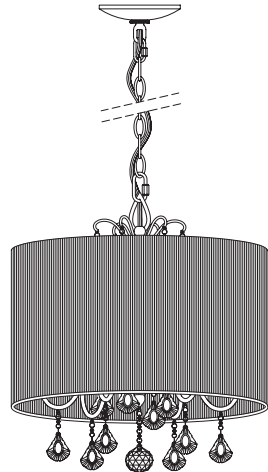

Assembled fixture

Care and Cleaning

- Clean the light fixture carefully with a soft, dry cloth. Do not use any cleaner with chemicals, solvents, or harsh abrasives.

Troubleshooting

Problem	Possible Cause	Solution
□ The bulb will not light.	□ The bulb is burned out.	□ Replace the light bulb.
	□ The power is off.	□ Ensure that the power supply is turned on.
	□ The circuit breaker is off.	□ Ensure that the circuit breaker is set to the ON position.
□ The fuse blows or the circuit breaker trips when the light is turned on.	□ There are too many items on one circuit.	□ Unplug the other items on the circuit. □ Contact a qualified electrician or call the Customer Service Team at 1-800-986-3460.

HOME DECORATORS COLLECTION

Questions, problems, missing parts? Before returning to the store,
call Home Decorators Collection Customer Service
8 a.m. - 7 p.m., EST, Monday-Friday, 9 a.m. - 6 p.m., EST, Saturday

1-800-986-3460

WWW.HOMEDEPOT.COM/HOMEDECORATORS

Retain this manual for future use.
