

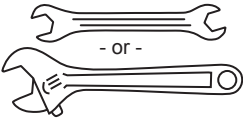

















2" Round In-Ground Mailbox Post with Side Braces (Model 7511) Assembly Instructions

Thank you for purchasing this premium mailbox post. We know you'll be satisfied with the years of service it will provide. If you have any questions about how to assemble or install this product, or if you need any replacement parts, please call us directly at (800) 464-7491 or contact us at www.architecturalmailboxes.com.

Assembly Instructions

Tools (not included)		Tools (included)	Hardware (included)		
Two open end wrenches 	Phillips head screwdriver 	Hex wrench 	To join the two post pieces:  x 2, braces  x 1, metal locking expansion  x 2, set screws  x 2, plugs	To attach the side metal braces:  x 4, small hex bolts  x 8, small washers  x 4, small hex nuts	To attach the mailbox to the plate: (For 3.75" and 11.25" side hole patterns)  x 4, small hex bolts  x 8, small washers  x 4, small hex nuts (For 5"x5" top hole pattern)  x 4, hex bolts  x 8, washers  x 4, hex nuts (For 4"x10" top hole pattern)  x 4, large hex bolts  x 8, large washers  x 4, large hex nuts

1

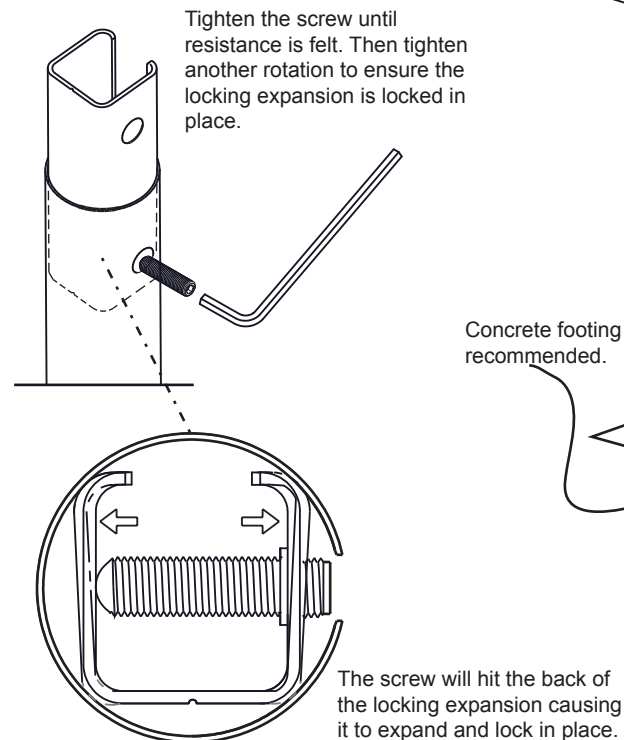
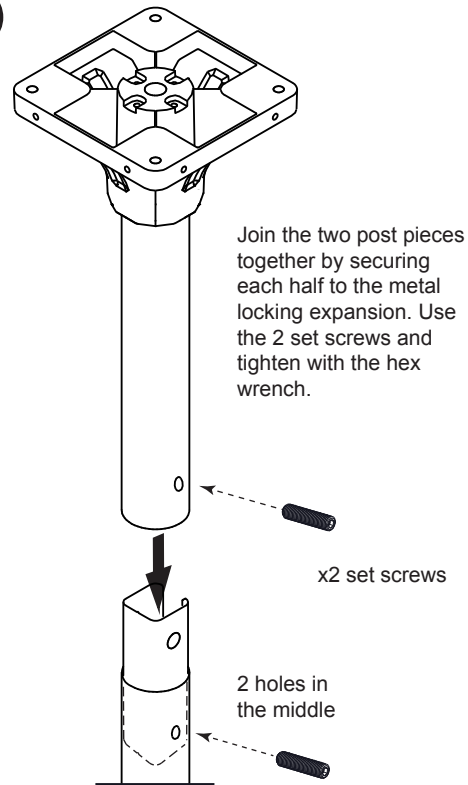

2

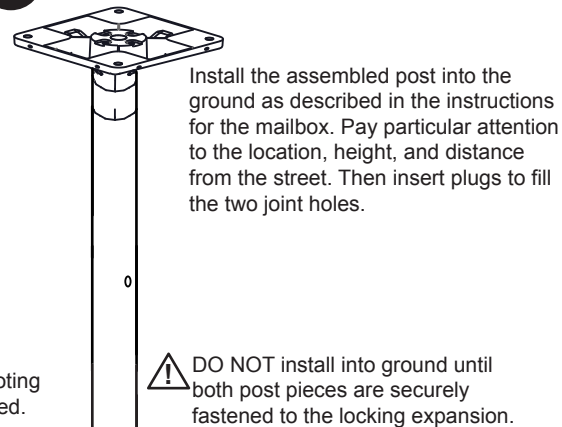

3

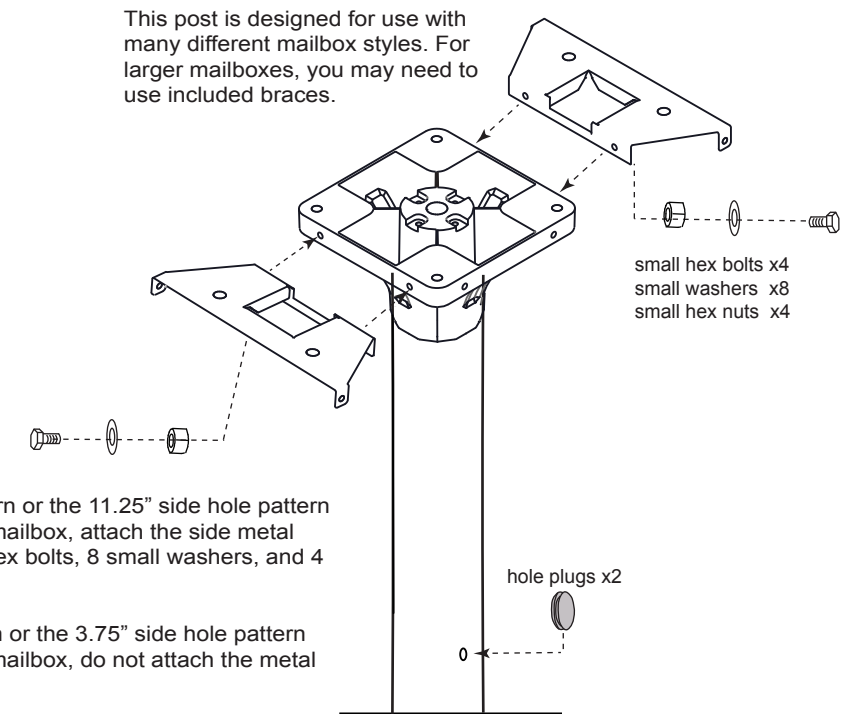

If the 4"x10" top hole pattern or the 11.25" side hole pattern will be used to mount the mailbox, attach the side metal braces using the 4 small hex bolts, 8 small washers, and 4 small hex nuts.

If the 5"x5" top hole pattern or the 3.75" side hole pattern will be used to mount the mailbox, do not attach the metal braces.

Finally, insert plugs to fill the two joint holes.