

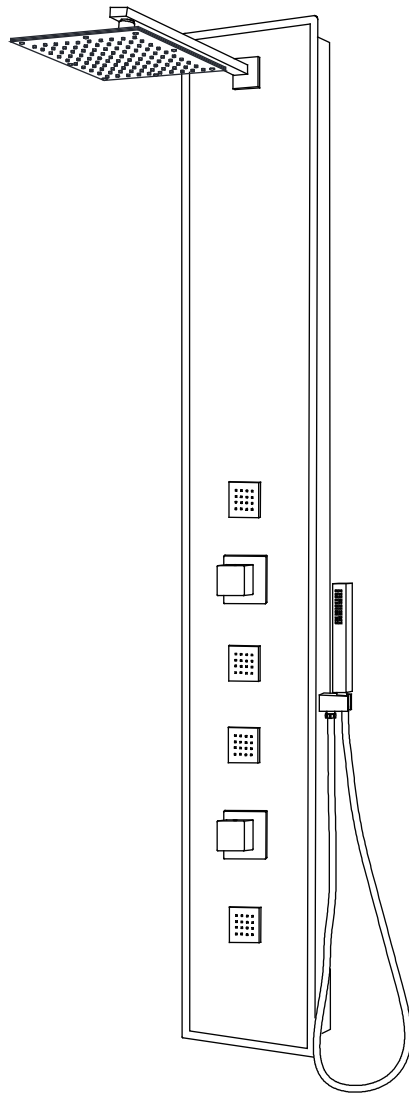

ANZZI™

LLANO Series
INSTALL GUIDE



Model#
SP-AZ046

PERFECTION IS OUR TRADITION™

TABLE OF CONTENTS

Parts List	Pg. 1
Before You Start	Pg. 2
Spec Drawing	Pg. 3
Installation	Pg. 4
Care & Maintenance	Pg. 10
Warranty	Pg. 11
Registration	Final Page

YOUR REVIEWS MATTER!



The ANZZI™ Family thanks you for your purchase and hopes you enjoy your very own ANZZI product for years to come! In the meantime let us know about your experience? We would love to hear your thoughts from the packaging to the quality and function of the product.

Leave a review on www.ANZZI.com/reviews and let everyone know how satisfied you are with ANZZI!

Also, we humbly request submitting as many pictures as possible along with your review. Millions of shoppers will want to know about your experience with our products. Don't just tell but show, too!

For more information please call 1-844-44-ANZZI
or email us at support@ANZZI.com

PARTS LIST

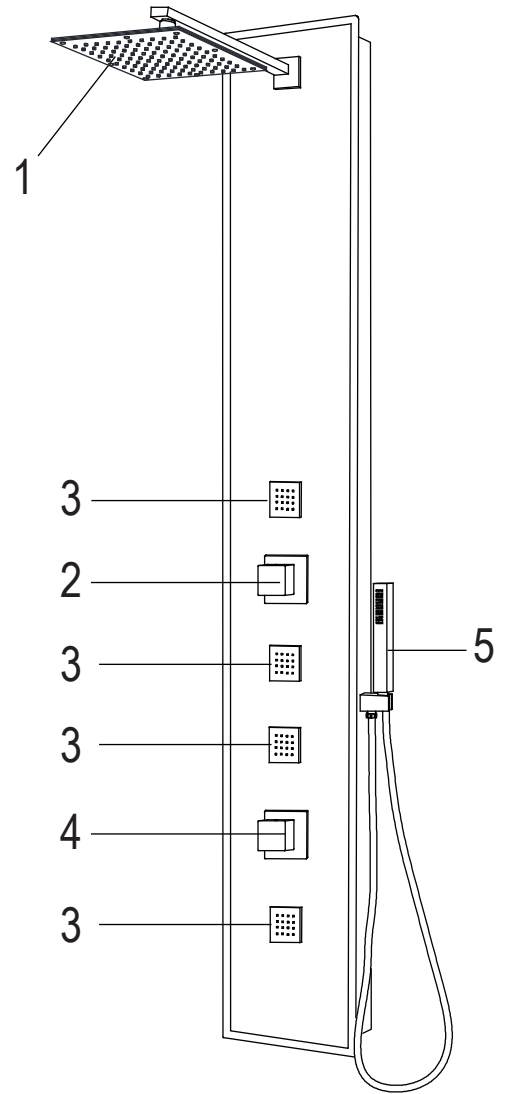
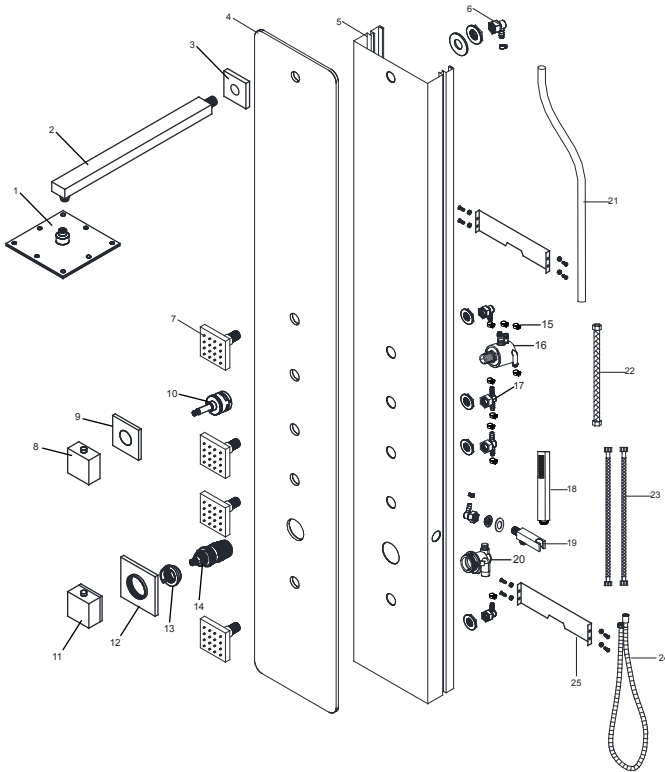

Component no.	Component	Material
1	head shower	s/s
2	arm bar	brass
3	flange	brass
4	front panel	tempered glass
5	back side panel	PVC
6	one way joint	ABS
7	body jets	brass
8	knob	zinc
9	knob plate	brass
10	function cartridge	ABS
11	handle	zinc
12	handle plate cover	brass
13	valve cap	ABS
14	thermostatic cartridge	ABS
15	clip	s/s
16	faucet 1	brass
17	two way joint	ABS
18	hand shower	ABS
19	hand shower holder	ABS
20	faucet 2	
21	pvc hose	PVC
22	braided hose 1	s/s
23	braided hose 2	s/s
24	flexible hose	s/s
25	fixing bar	s/s

- 1. Shower Head
- 2. Diverter
- 3. Body Jets
- 4. Mixer
- 5. Hand Shower

PERFECTION IS OUR TRADITION™

BEFORE YOU START

Recommended Items

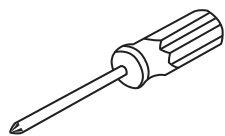

Screwdriver

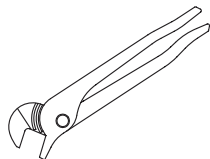

Channel Locks



Goggles

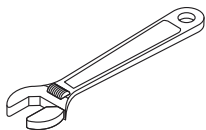

Adjustable Wrench



Teflon tape

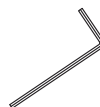

Allen key

ATTENTION: Please read all instructions thoroughly including all warnings, attentions and notes before beginning installation.

For any questions or concerns contact our dedicated technical support team at 1-844-44-ANZZI.

PERFECTION IS OUR TRADITION™

SPEC DRAWING

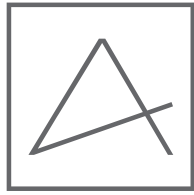

ANZZI™

Perfection is our Tradition™

LLANO Series

SP-AZ046

Material: Tempered Glass
Finish: Black Tempered Glass
Handles: 2
Jets: 4
Shower: 6.89" x 6.89"
Sprayer: 60" reach
Weight: 27.06 lbs
Height: 59.05"
Supply: 1/2" connections
Flow: 2.5 gpm

Features

Heavy Rain™ Showerhead
Acu-Stream™ high pressure body jets
Euro-Grip™ hand held sprayer
Rhino Alloy™ certified materials

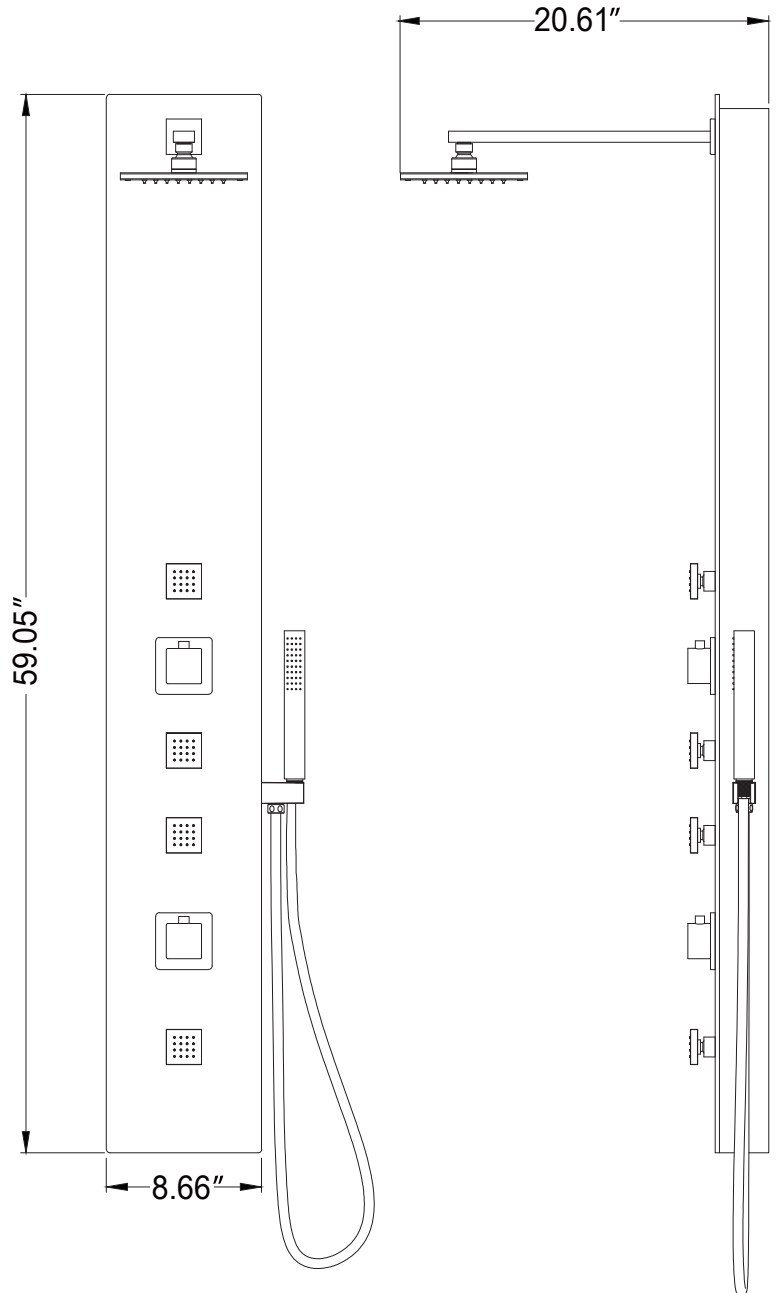

PERFECTION IS OUR TRADITION™

INSTALLATION (SETUP)

Figure A



IMPORTANT Before drilling any holes for the shower panel brackets, ensure there are no hidden cables or pipelines aligned with the desired drilling position.

Step A Drill the two holes for the top bracket 1" apart at the desired height.

Step A.2 Drill the two holes for the bottom bracket 1" apart at approximately 45" below the top bracket.

INSTALLATION (SETUP)

Figure B



Figure C



Step B Insert the wall anchors into the pre-drilled holes as shown in Figure B.

Step C Place the shower panel brackets aligned with the drilled holes and using a Philips screwdriver tighten the screws to secure the brackets.

PERFECTION IS OUR TRADITION™

INSTALLATION (HANDSHOWER)

Figure 1

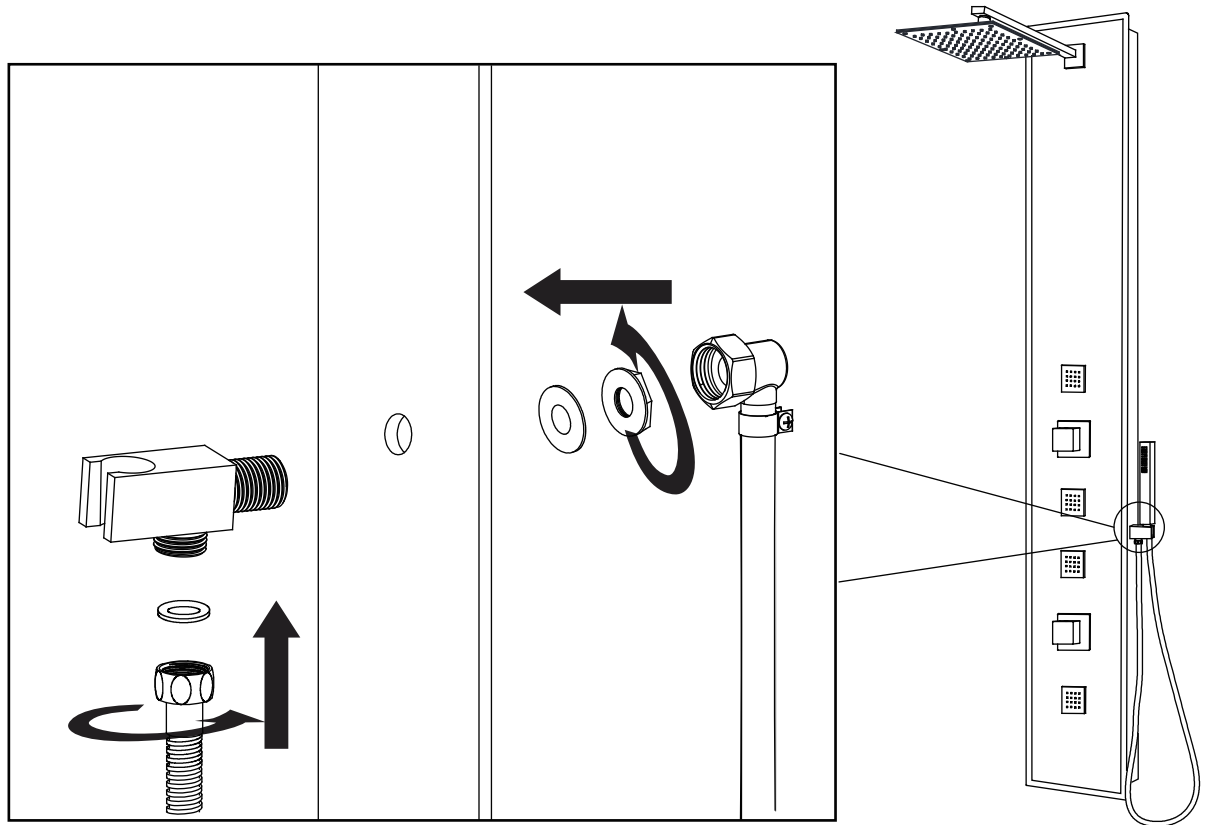

- Step 1A** Insert the shower wand holder through the pre-drilled hole on the shower panel.
- Step 1B** Install the water supply hose for the shower wand onto the holder, as shown.
- Step 1C** Make sure all O-rings are inserted to prevent leakage.
- Step 1D** Once the shower panel is fully installed and hung on the bracket, you can install the shower wand hose to the holder connection.

INSTALLATION (HANDSHOWER)

Figure 2

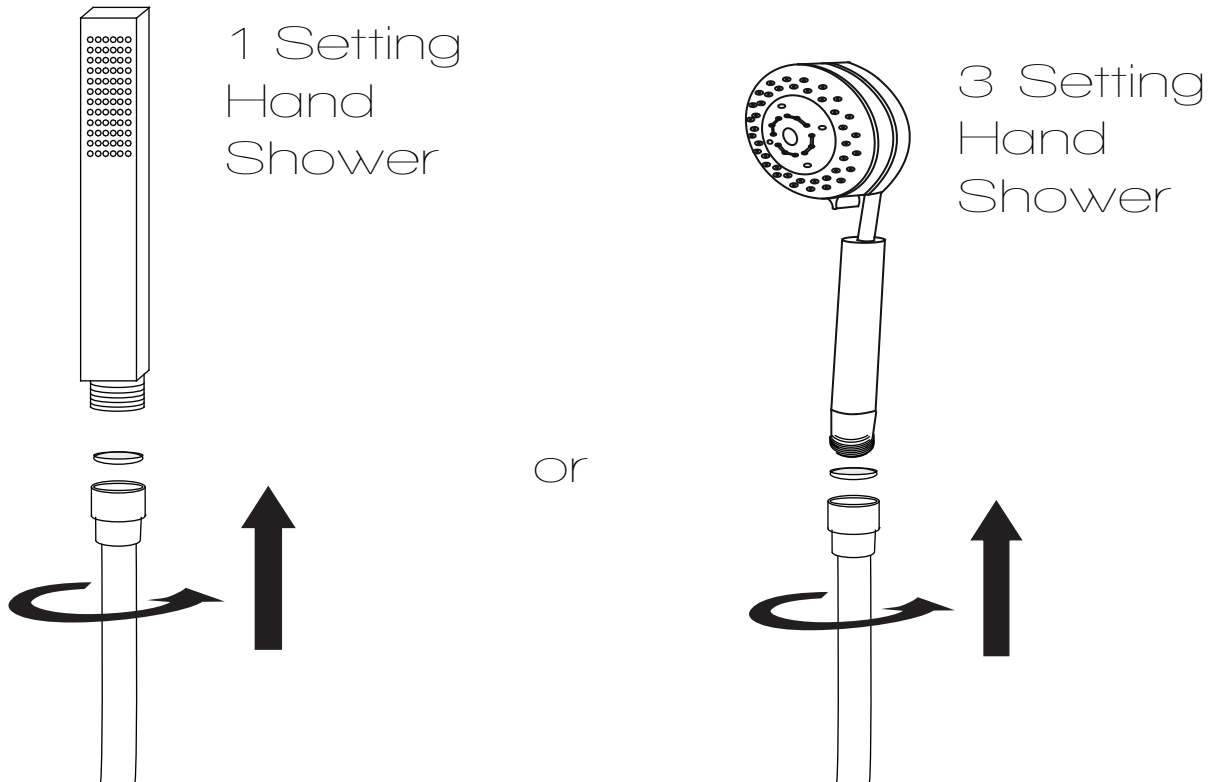

Step 2A Finally, install the shower wand to the hose, as shown.

INSTALLATION (SHOWER HEAD)

Figure 3

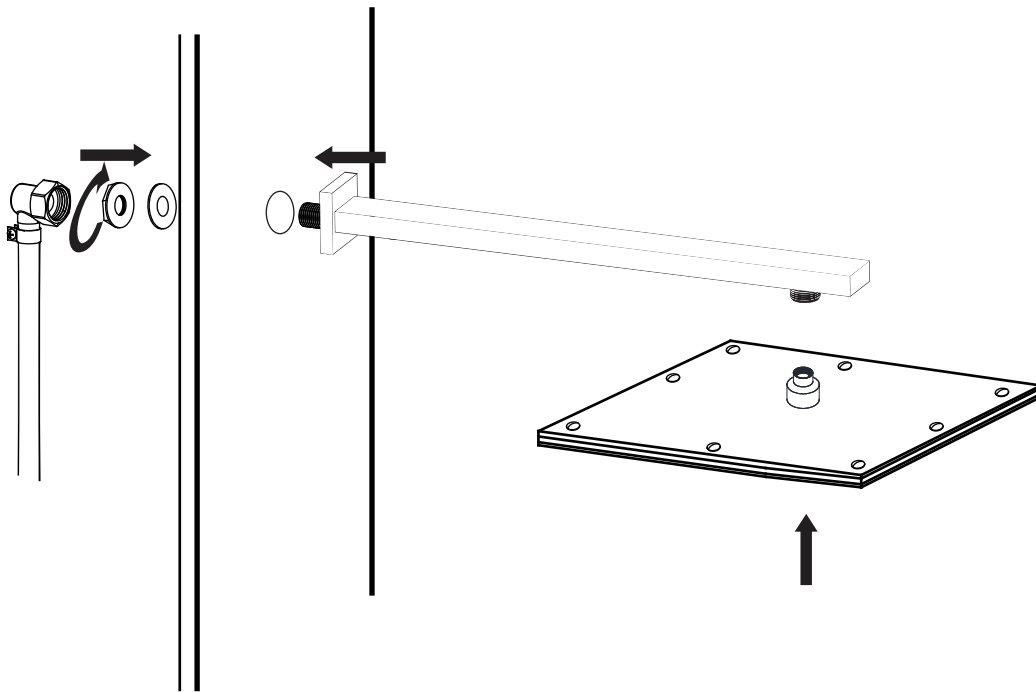

- Step 3A** Install the shower arm to the shower panel, using the rubber washer and nut on the opposite side to tighten.
- Step 3B** Makes sure the shower arm is sitting correctly before installed the shower head.
- Step 3C** Screw the shower head onto the shower arm.

PERFECTION IS OUR TRADITION™

INSTALLATION (WALL MOUNTING)

Figure 4

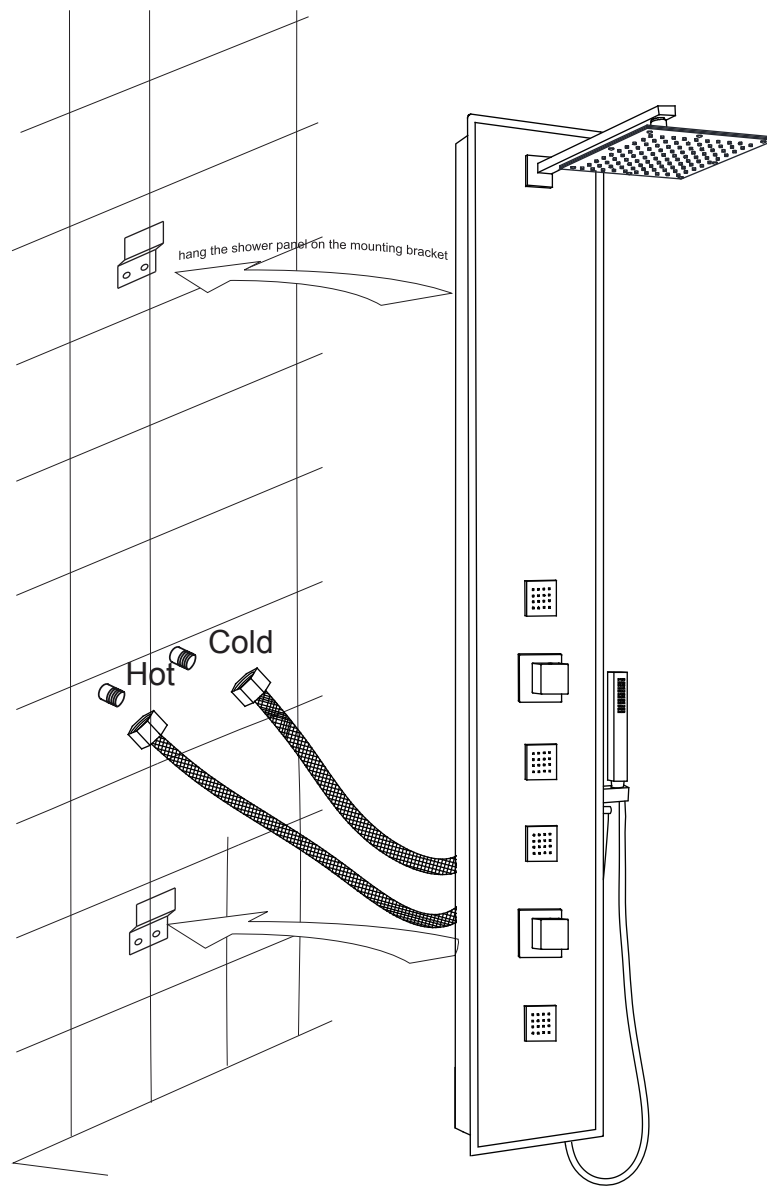

Step 4A Screw the cold and hot water hose from the shower panel to the supply lines in the wall.

Step 4B Carefully hang the shower panel on the secured mounting brackets as shown in Figure 4.

PERFECTION IS OUR TRADITION™

CARE AND MAINTENANCE

ANZZI™ products are crafted with superior quality standards and workmanship and are engineered to stand the test of time. However, that does not mean the product can be neglected and will need some care and cleaning.

It is recommended to use regular soap and hot water along with a non-abrasive cloth or sponge to regularly clean the product. This avoids any nasty build up or deposits which would be tougher to remove.

If you feel the use of stronger cleaning solutions or chemicals is necessary always test the cleaning solution or chemical on an inconspicuous area before applying to the entire surface.

Wipe all surfaces clean and rinse completely with water immediately after applying cleaner. Rinse and dry any overspray that lands on nearby surfaces.

DO NOT ALLOW THE CLEANER TO SOAK.

Following these simple principles will ensure your ANZZI™ product will remain as lustrous and stunning as the day it was first received. ENJOY!

Sincerely,

La Familia ANZZI™

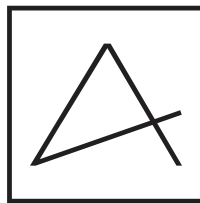

ANZZI™

Perfection is our Tradition™

For more information visit us at www.ANZZI.com

LIMITED LIFETIME WARRANTY

ANZZI™ products are manufactured with superior quality standards and workmanship and are backed by our limited lifetime warranty. ANZZI™ products are warranted to the original consumer purchaser to be free of defects in materials or workmanship. We will replace FREE OF CHARGE* any product or parts that proves defective. Simply call 1-844-44-ANZZI (1-844-442-6994) to submit a warranty claim and request an RMA. Proof of purchase (original sales receipt) from the original consumer purchaser must be made available for all ANZZI™ warranty claims.

This warranty excludes incidental/inconsequential damages and failures due to misuse, abuse or normal wear and tear. This warranty excludes all industrial, commercial & business usage, whose purchasers are hereby, extended a five year limited warranty from the date of purchase, with all other terms of this warranty applying except the duration of warranty.

Some states and provinces do not allow the exclusion or limitation of incidental or consequential damages, so the above limitations may not apply to you. This warranty gives you specific legal rights and you may also have other rights that vary from state to state and province to province. Please contact 1-844-44-ANZZI (1-844-442-6994) or visit www.ANZZI.com/Warranty for more details.

Sincerely,

La Familia ANZZI™

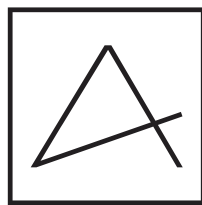

ANZZI™

Perfection is our Tradition™

*Shipping and handling fees are not covered under the ANZZI™ Warranty.

This warranty is in effect as of January, 2016. This warranty supersedes all previous warranties and/or claims both stated and implied. This warranty is subject to change without notice.

PRODUCT AND WARRANTY REGISTRATION

To register your product and activate your Limited Lifetime Warranty contact us at 1-844-44-ANZZI or email us at support@ANZZI.com. Or, if preferable, fill out the form below then scan/fax/mail us a copy.

Email: support@ANZZI.com

Fax: 1-866-560-1060

Mail: ANZZI™
5701 NW 35th Ave.
Miami, FL 33142

In need of replacement parts?
Visit www.SpaWorldParts.com

ANZZI™ Product Registration Card

Name.....

Address

City State Zip

Phone

Email.....

Date of Purchase..... Dealer

Address

Installed by

Address State

Phone State..... Zip.....

Email.....

I have read the ANZZI™ Owner's Manual carefully and understand and agree that any installation, operation or maintenance of the product must be done strictly in accordance with instructions and guidelines contained in the ANZZI™ owner's manual and installation guide.

Signature _____ Date _____

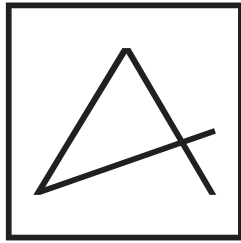

ANZZI™

Perfection is our Tradition™