

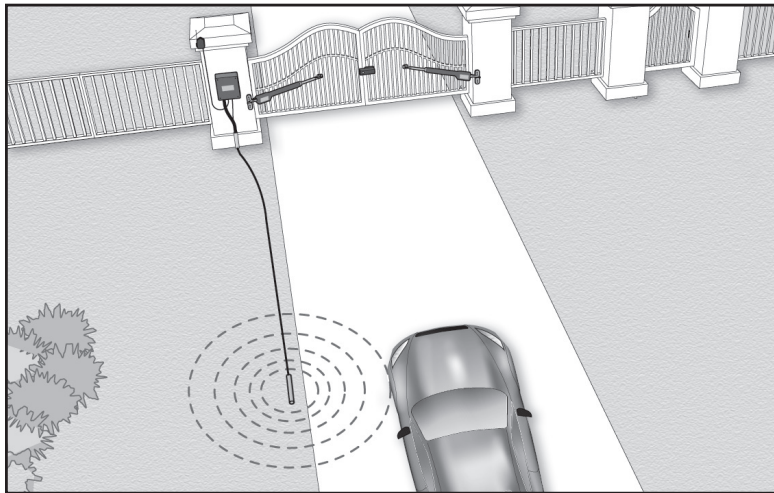

VEHICLE SENSOR

INSTALLATION MANUAL



⚠ WARNING ⚠

When an VEHICLE SENSOR is in use, the automatic gate opener could be activated by a child on a bicycle or other metal play equipment. This Product is not recommended for applications exposed to children.

Parts Identification:

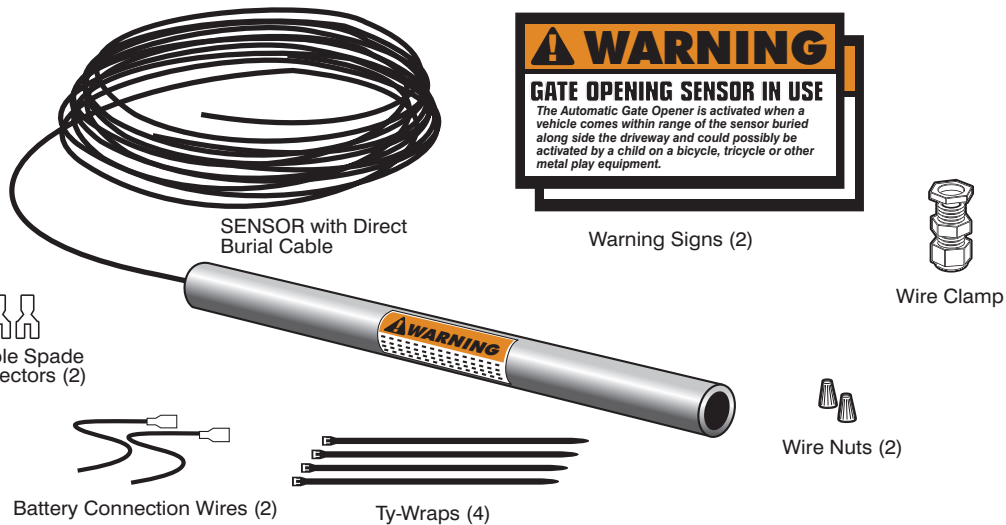

INSTALLATION OVERVIEW

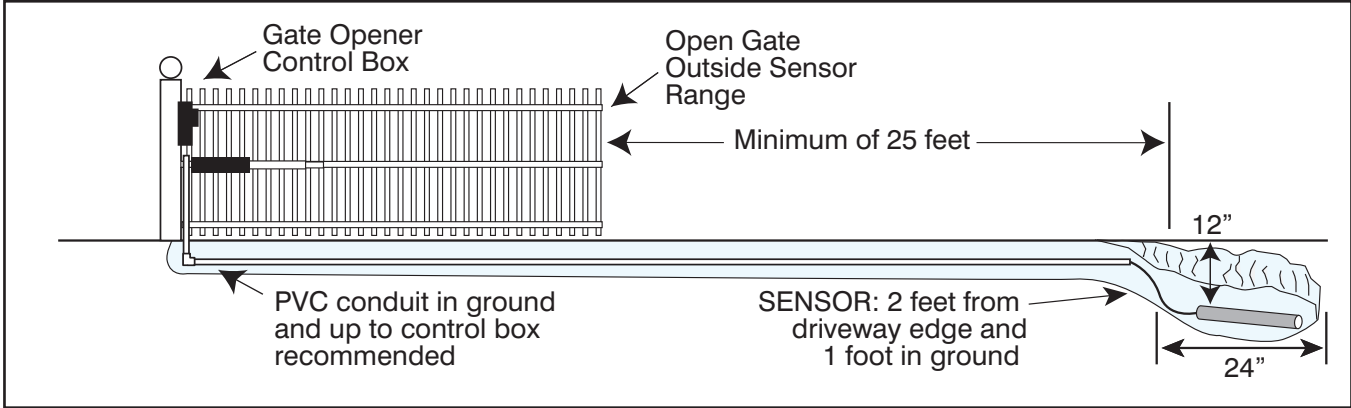

- The SENSOR is designed to detect iron-based metal **in motion**.
- The SENSOR's ability to detect iron-based metal objects is based on the mass, velocity and proximity of the object to the sensor.
EXAMPLE - A child's bicycle moving at 2 mph @ 1' from the sensor has a similar effect as a car moving at 2 mph @ 6' from the sensor.
- The SENSOR must be stationary to function properly.

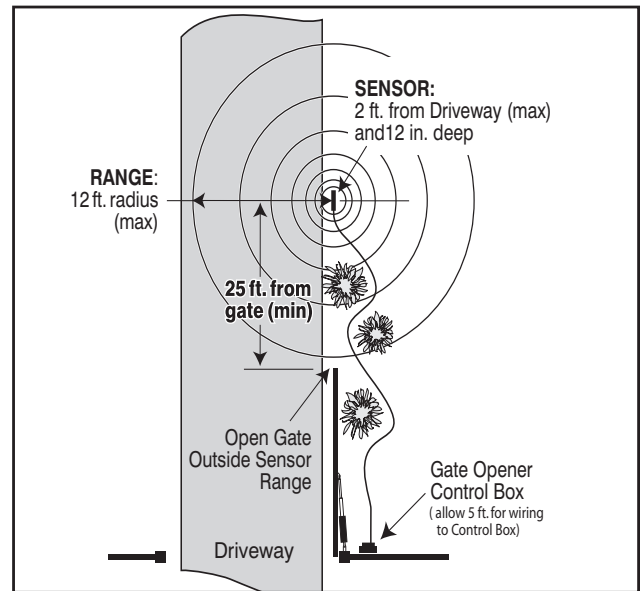

WIRING THE WAND

1.

Obtain the instruction manual for the gate opener.

2.

Locate the control terminals (2) that will **ONLY OPEN** the gate.

3.

Verify that the above inputs when shorted (a small wire connecting the 2 terminals) will do all of the following:

- **OPEN** the gate if the gate is idle.
- **STOP** and then **OPEN** the gate if gate is closing.
- **DO NOTHING** if the gate is opening.

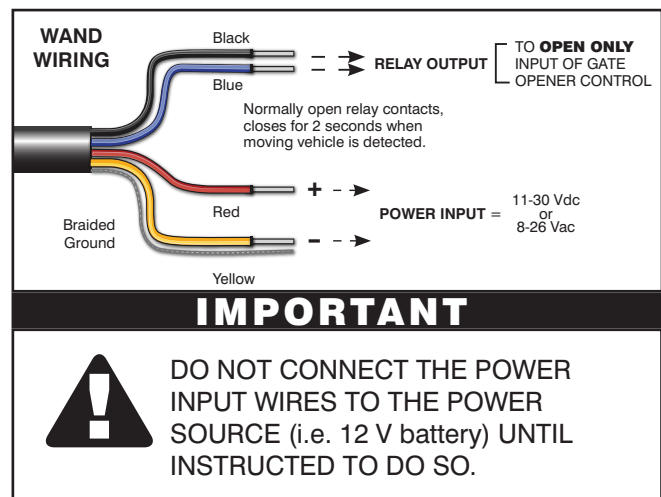

TURN GATE OPENER OFF

4.

Connect the **BLACK** to the terminal labeled **COMMON**, and the **BLUE** wire to terminal in **STEP 3** to open gate.

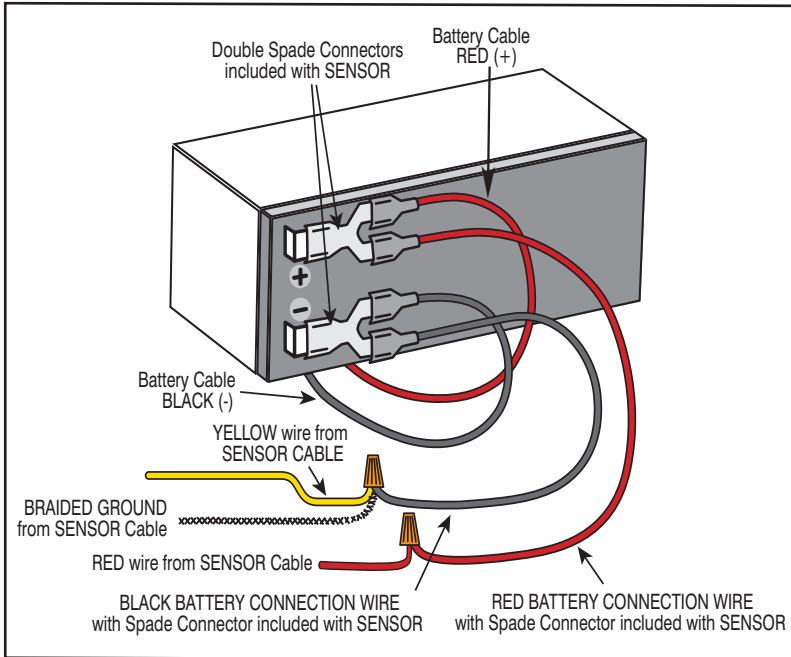

5.

Connect the **POWER INPUT** wires to power source.

- Connect the **YELLOW** and **BRAIDED GROUND** wires to the **(-) NEGATIVE** side of power source. (i.e. battery)
- Connect the **RED** wire to the **(+) POSITIVE** side of power source. (i.e. battery)

IMPORTANT



WHEN THE WAND IS FIRST POWERED UP IT MUST BE UNDISTURBED FOR 60 SECONDS TO PERFORM THE SELF TEST AND CALIBRATIONS. BEFORE POWERING THE WAND MAKE SURE THERE ARE NO MOVING METAL OBJECTS OR MOVING VEHICLES WITHIN THE RANGE OF THE WAND

6.

Turn opener **ON** and **TEST**.

WIRING DIAGRAM EXAMPLES

NOTE: Power Input Connections Not Shown.
(See gate instruction manual for complete instructions)

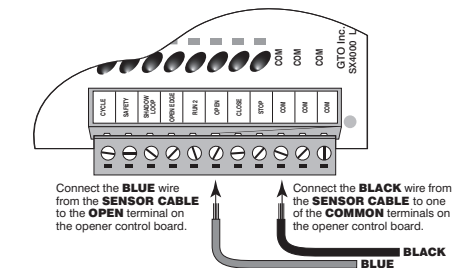
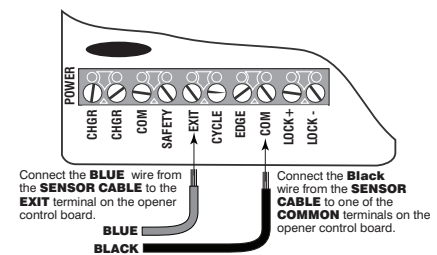
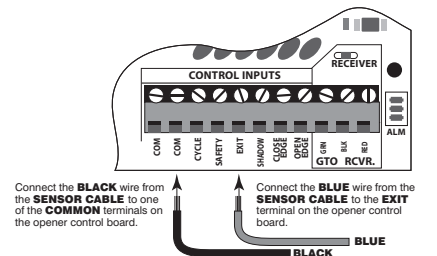
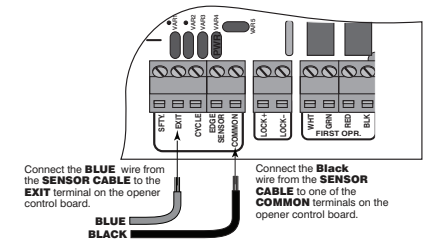
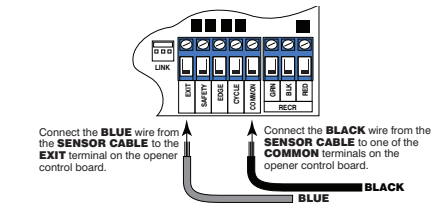
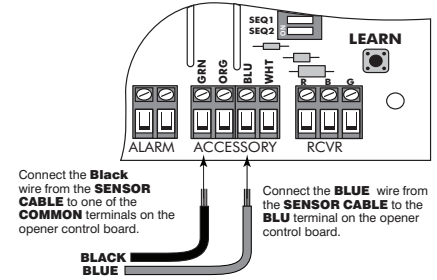

TECHNICAL SPECIFICATIONS:

- Power Supply: 8-26 Vac - 11-30 Vdc
- Current consumption 3 mA. typical
- Relay rating: 1 amp max, 30 Vdc
- Relay Pulse Time: 2 seconds
- Operating Temperature: 25°F (-14°C) to 125°F (-69°C), or battery operating temperature
- Dimensions: 1¾" (44.5 mm) diameter x 16½" (42cm) long

TROUBLESHOOTING: *Make sure all connections are correct*

- Disconnect the power (battery) to the WAND.
- Reconnect the power to the WAND and make sure that no metal object or vehicle is moving around the WAND for 60 seconds while it is calibrating.
- Test the WAND to verify that it is working properly.



This product and any accessory you purchase should only be installed on a gate opener that meets the current safety standard, UL325. If you have a gate opener that is not listed with the current standard please contact GTO sales department for consultation on a gate opener that can meet your specific needs.

Conversion Chart

Converting Metric Units to English Equivalents

When You Know	Multiply by	To Find	Symbol
Centimeters	0.3937	Inches	in. (")
Meters	3.2808	Feet	ft. (')
Kilograms	2.2046	Pounds	lb. (#)

Converting English Units to Metric Equivalents

When You Know	Multiply by	To Find	Symbol
Inches	2.5400	Centimeters	cm
Feet	0.3048	Meters	m
Pounds	0.4535	Kilograms	kg

Converting Temperature

deg. Celsius	$(^{\circ}\text{C} \times 1.8) + 32$	deg. Fahrenheit	$^{\circ}\text{F}$
deg. Fahrenheit	$(^{\circ}\text{F} - 32) \div 1.8$	deg. Celsius	$^{\circ}\text{C}$

GTO LIMITED ONE YEAR WARRANTY

Gates that Open, LLC (GTO), accessories are warranted by the manufacturer against defects in materials and manufacturer workmanship for a period of one (1) year from date of purchase, provided the recommended installation procedures have been followed.

In the case of product failure due to defective material or manufacturer workmanship within the one (1) year warranty period, the product will be repaired or replaced (at the manufacturer's option) at no charge to the customer, if returned freight prepaid to GTO, 3121 Hartsfield Road, Tallahassee, Florida, USA 32303. IMPORTANT: Call (800) 543-1236 for a Return Goods Authorization (RGA) number before returning accessory to factory. Products received at the factory without an RGA number will not be accepted. Replacement or repaired parts are covered by this warranty for the remainder of the one (1) year warranty period or six (6) months, whichever is greater.

GTO will pay the shipping charges (equal to United Parcel Service GROUND rate) for return to the owner of items repaired under warranty.

The manufacturer will not be responsible for any charges or damages incurred in the removal of the defective parts for repair, or for the reinstallation of those parts after repair. This warranty shall be considered void if damage to the product(s) was due to improper installation or use, connection to an improper power source, or if damage was caused by electrical power surge or lightning, wind, fire, flood, insects or other natural agent.

After the one (1) year warranty period, GTO will make any necessary repairs for a nominal fee. Call GTO at (800) 543-1236 for more information. This warranty gives you specific legal rights, and you may also have other rights which may vary from state to state. This warranty is in lieu of all other warranties, expressed or implied. **NOTE: Verification of the warranty period requires copies of receipts or other proof of purchase. Please retain these records.**

**For your nearest dealer, please call 1-800-543-GATE (4283)
or visit www.mightymule.com**