

INSTALLATION INSTRUCTIONS FOR DOUBLE WALL MOUNTED STORAGE SHELF

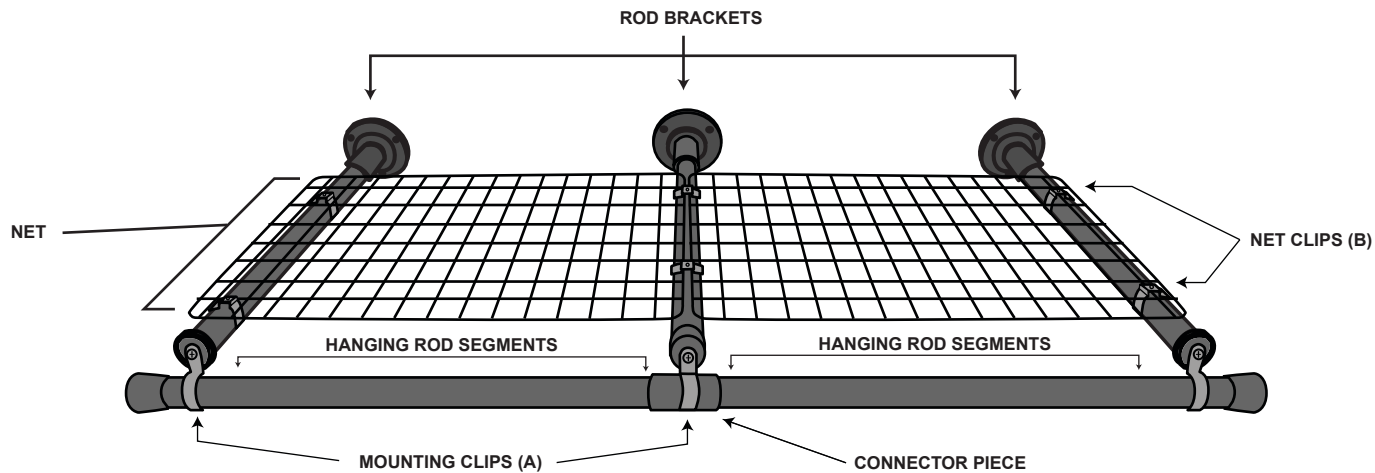

1 Lightly mark points on the wall where shelf will be mounted.

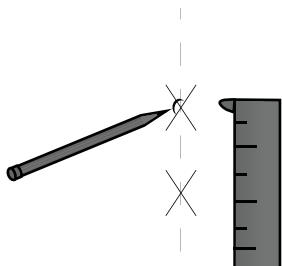

2 Retrieve the mounting template from the package of components along with 3 double sided adhesive pieces of tape. Peel off one side of the tapes' covers and stick them on the backside of the mounting template.

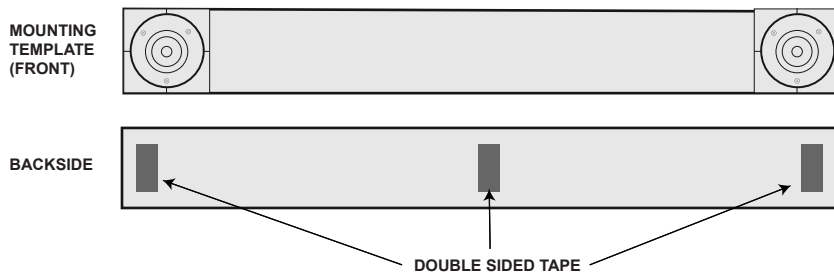

3 Use a level when sticking the template to the wall. Mark the wall through the template to spot the drill holes for the first 2 brackets. For the third bracket, you will be shifting the template horizontally left or right depending on your preferences. When ready, mark the final holes.

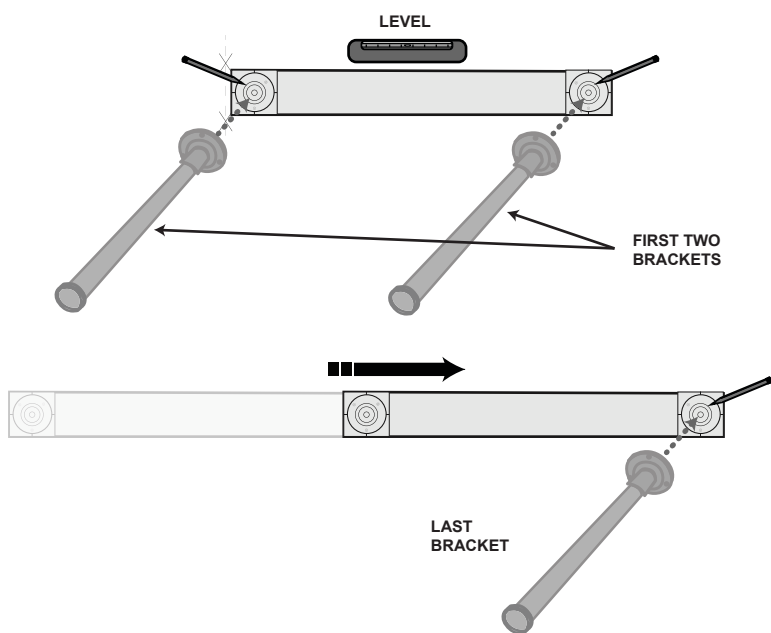

4 Remove the template and drill holes at the marked locations. Firmly seat drywall anchors using a mallet and use screws to mount the brackets.

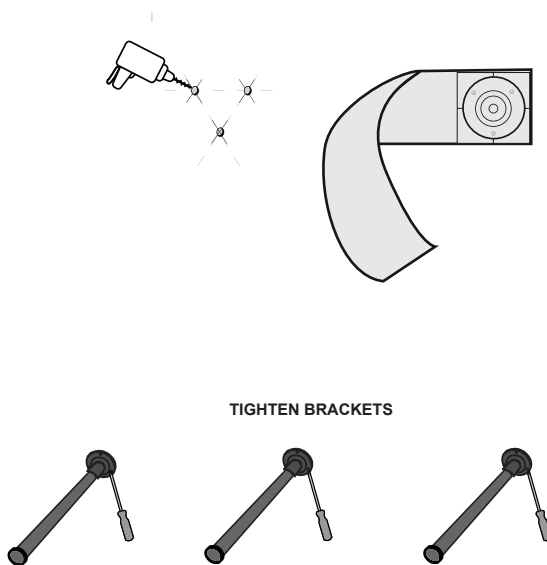

DRYWALL ANCHOR INSTALLATION



If screws are going directly into wood trim or wall studs - drill 1/8" (3mm) holes and install screws through bracket. If screws are going into hollow wall - drill 3/16" (5mm) holes and push or lightly hammer plastic anchors into holes. Then install screws through brackets. Do not tighten screws too much - just snug is best.

- 5** Find the connector piece and use it to adjoin the 2 rod segments. Then place a mounting clip (A) on the rod connector and insert a screw into the hole. Screw and tighten the connector onto the middle bracket.

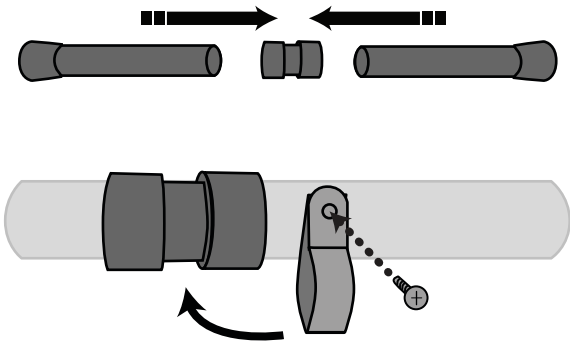

- 6** Proceed to attach mounting clips to ends of the hanging rod segments and attach them to the outer rod brackets with screws.

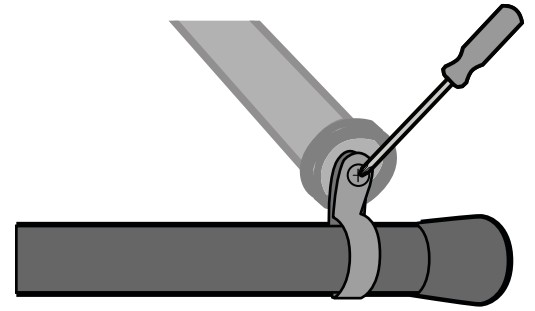

- 7** Place nets on the rod brackets. Fasten the metal nets to the brackets by placing 2 net clips (B) on each bracket (see example below). Once you have done so, the shelf is completed.

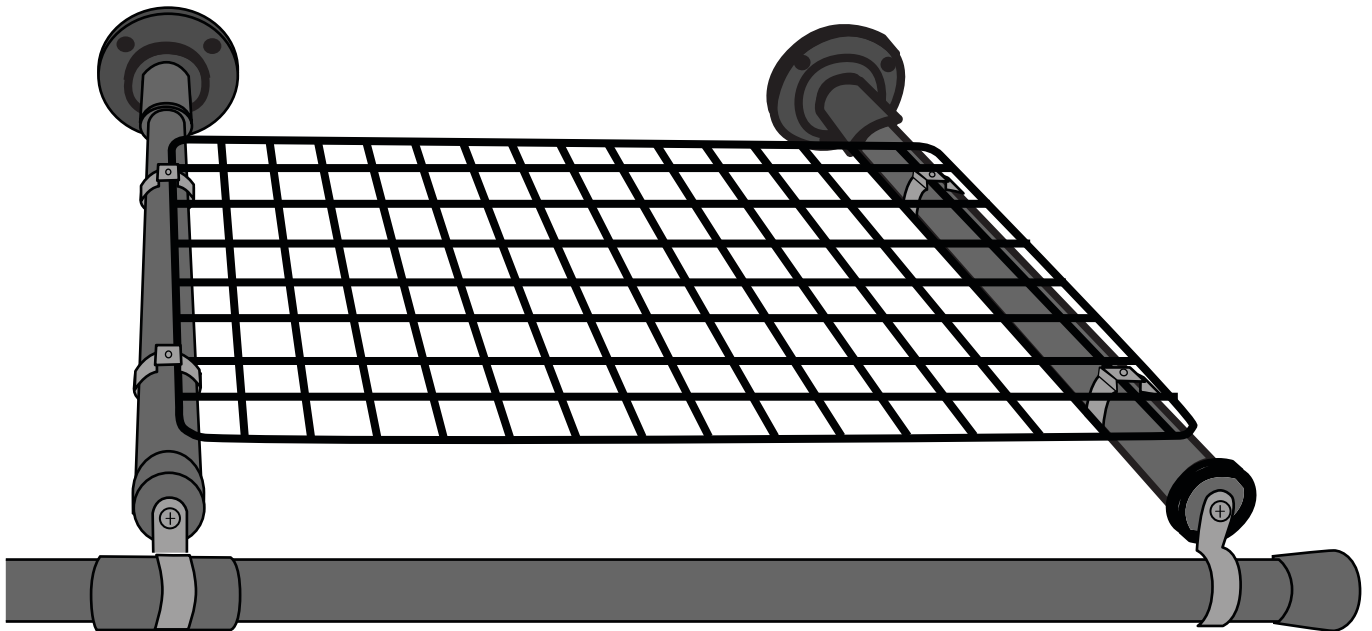

METAL WALL ANCHOR INSTALLATION*



*USE ON 3/8"-1/2" THICK WALLS ONLY!

- 1** Drill a hole into the wall, using a 1/4"(6mm) inch drillbit.



- 3** Attach drill or screwdriver to head of screw and expand the anchor by tightening the head.

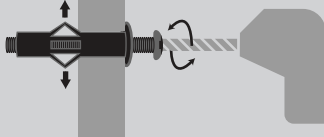

- 2** Tap the anchor into the hole until it is flush with the surface of the substrate.

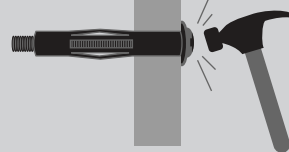

- 4** Remove the screw and place it through the fixture then back into the anchor. Tighten the screw until the fixture is secure.

