

# OUTDOOR GRILL USE

This manual covers several different models. The grill you have purchased may have some or all of the features listed. The locations and appearances of the features shown here may not match those of your model.

## Control Panel

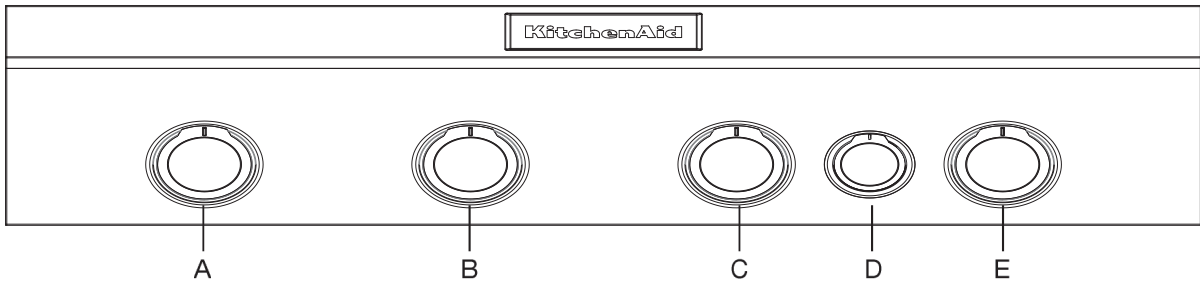

- A. Left main burner control knob      B. Left center main burner control knob      C. Right center main burner control knob  
D. Rotisserie burner control knob      E. Right main burner control knob

## Using Your Outdoor Grill

### **⚠ WARNING**



#### Explosion Hazard

Do not store fuel tank in a garage or indoors.  
Do not store grill with fuel tank in a garage or indoors.  
Failure to follow these instructions can result in death, explosion, or fire.

### **⚠ WARNING**



#### Fire Hazard

Do not use grill near combustible materials.  
Do not store combustible materials near grill.  
Doing so can result in death or fire.

### **⚠ WARNING**

#### Food Poisoning Hazard

Do not let food sit for more than one hour before or after cooking.  
Doing so can result in food poisoning or sickness.

## Inspect the LP Gas Fuel Tank Supply Hose

Inspect the gas pressure regulator/hose assembly before each use.

1. Open left-hand cabinet door.
2. Inspect the gas pressure regulator/hose assembly for cuts, abrasions, or excessive wear.
3. If necessary, replace the gas pressure regulator/hose assembly before using the grill.  
Contact the dealer and use only replacement hoses specified for use with the grill.

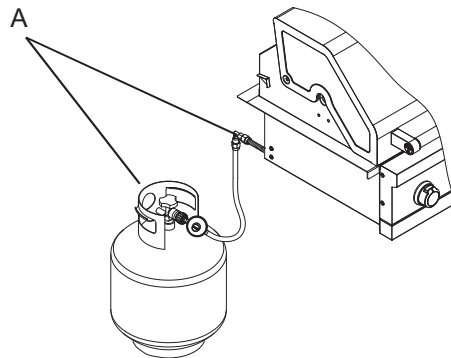

A. Gas pressure regulator/Hose assembly

---

## Turn the Gas Supply On

---

1. For outdoor grills using a 20 lb LP gas fuel tank:  
Slowly open the tank valve.  
**NOTE:** If flow limiting device activates, your grill may not light. If your grill does light, the flames will be low and will not heat properly. Turn tank valve and all control knobs off and wait 30 seconds. After shutting off the tank, very slowly open tank valve and wait 5 seconds before lighting.
2. For outdoor grills using gas supply source other than a 20 lb LP gas fuel tank:  
Open the manual shutoff valve in the gas supply line. The valve is open when the handle is parallel to the gas pipe.

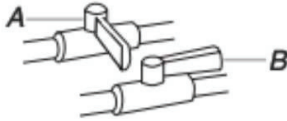

A. Closed valve  
B. Open valve

---

## Lighting the Grill Burners

---

**IMPORTANT:** If burner does not light immediately, turn the burner knob to OFF and wait 5 minutes before relighting.

1. Open the hood completely. Do not light burners with the hood closed.
2. Do not lean over the grill.
3. Select the burner you want to light. Push in and turn the grill burner control knob to IGNITE/HI, while continuing to hold it in.

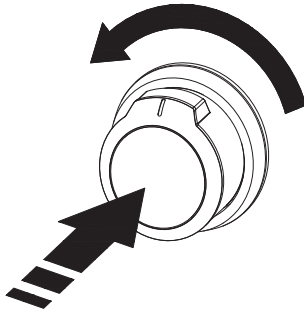

4. You will hear the “snapping” sound of the spark. When burner is lit, release the knob. Turn knob to desired setting.
5. Repeat for each of the other burners as needed.

---

## Manually Lighting Grill Burners

---

1. Open the hood completely. Do not light burners with hood closed.
2. Do not lean over the grill.
3. Remove the manual lighting extension (see following illustration) and attach a match to the split ring.

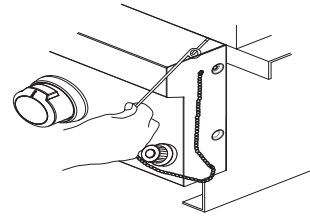

4. Strike the match to light it.
5. Guide the lit match under the grill grate.

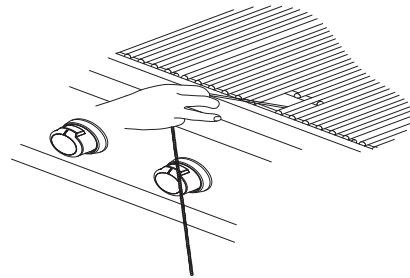

6. Push in and turn the burner knob to IGNITE/HI for the burner closest to the lit match. The burner will light immediately. When burner is lit, turn knob to desired setting.

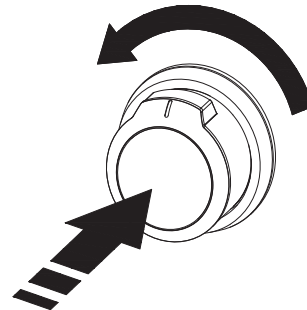

7. Repeat steps 2 through 6 for each main burner.
8. Remove match and replace manual lighting extension on the right side panel.

### **IMPORTANT:**

If burner does not light immediately, turn the burner knob to OFF and wait 5 minutes before relighting.

If any burners do not light after attempting to light them manually, contact the Customer Service Center. See the “Assistance” section.

## Using Your Rotisserie Burner

A Rotisserie kit can be purchased as an accessory for the grill. See "Accessories" in the "Assistance" section. To avoid damage to the warming rack, remove from grill when using the rotisserie burner. Do not use the main burners when the rotisserie burner is in use.

### Lighting the Rotisserie Burner

1. Open the hood completely. Do not light burner with the hood closed.
2. Do not lean over the grill.
3. When the rotisserie burner lights, continue to hold the knob in for another 10 seconds, then release the knob and burner will stay lit. You will hear the "snapping" sound of the spark until the knob is released.

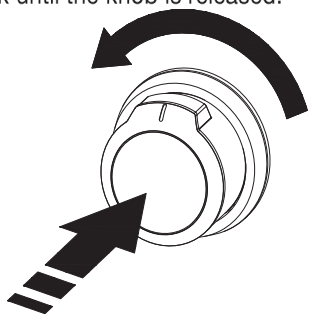

**IMPORTANT:** If burner does not light immediately, turn the burner knob to OFF and wait 5 minutes before relighting.

### Manually Lighting The Rotisserie Burner

1. Open the hood completely. Do not light burner with the hood closed.
2. Do not lean over the grill.
3. Remove the manual lighting extension (see the following illustration) and attach a match to the split ring.

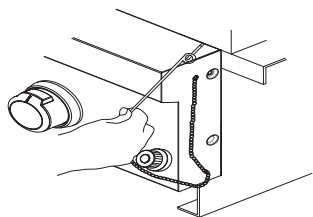

4. Strike the match to light it.
5. Hold the lit match close to the rotisserie burner.

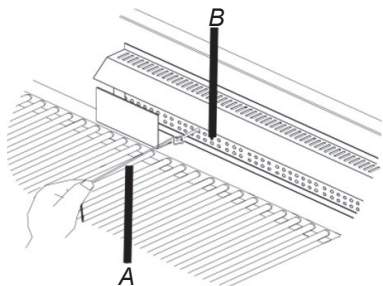

A. Lighting extension  
B. Rotisserie burner

6. Push in and turn the control knob to IGNITE/ON. For the burner closest to the lit match. The burner will light immediately. When burner is lit, turn knob to desired setting.

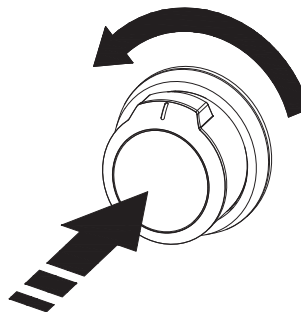

**IMPORTANT:** If the rotisserie burner does not light immediately, turn the rotisserie burner control knob to OFF and wait 5 minutes before relighting.

7. Remove the match and replace the manual lighting extension on the right side panel.

---

# TIPS FOR OUTDOOR GRILLING

---

## **⚠ WARNING**

### **Food Poisoning Hazard**

**Do not let food sit for more than one hour before or after cooking.**

**Doing so can result in food poisoning or sickness.**

---

### **Before Grilling**

---

- Thaw food items before grilling.
- Preheat grill on high (use all grill burners) 10 minutes. The hood must be closed during preheating. Preheating provides the high heat needed to brown and seal the juices.
- Shorten the preheat time when grilling high-fat cuts of meat or poultry, such as chicken thighs. This will help reduce flare-ups.
- Lightly oil the grill grates or the food when cooking low-fat cuts of meat, fish or poultry, such as lean hamburger patties, shrimp or skinless chicken breasts.
- Using too much oil can cause gray ash to deposit on food. Trim excess fat from meats prior to cooking to reduce flare-ups.
- Make vertical cuts at 2" (5 cm) intervals around the fat edge of meat to avoid curling.
- Add seasoning or salt only after the cooking is finished.

---

### **During Grilling**

---

- Turn foods only once. Juices are lost when meat is turned several times.
- Turn meat just when juices begin to appear on the surface.
- Avoid puncturing or cutting the meats to test doneness. This allows juices to escape.
- It may be necessary to lower the heat setting for foods that cook a long time or are marinated or basted in a sugary sauce.
- If using a high flame, add barbecue sauce only during the last 10 minutes of cooking to avoid burning the sauce.
- The degree of doneness is influenced by the type of meat, cut of meat (size, shape and thickness), heat setting selected, and length of time on the grill.
- Cooking time will be longer with an open grill cover.

---

## **Cooking Methods**

---

---

### **Direct Heat**

---

Cooking by direct heat means the food is placed on grill grates directly above lighted burners. Hood position can be up or down. If hood is in the up position, total cooking times may be longer.

Direct heat sears the food. Searing is a process that seals natural juices in food by cooking with intense heat for a short period of time. While juices stay inside, the outside is browned with a flavorful grilled coating.

---

### **Indirect Heat**

---

For best results, do not select the indirect heat cooking method when it is windy.

Cooking by indirect heat means the food is placed on the grill grate above an unheated burner, allowing heat from lighted burner(s) on either side to cook the food.

If possible, turn on 2 burners. Cook with the hood down. This will shorten the cooking time.

## Rotisserie Cooking Tips

### ⚠ WARNING

#### Food Poisoning Hazard

**Do not let food sit for more than one hour before or after cooking.**

**Doing so can result in food poisoning or sickness.**

Rotisserie cooking rotates food in front of the rotisserie burner, creating an intense heat for searing the outside and sealing in natural juices.

The rotisserie burner reaches cooking temperatures in about

- Select tender meat and poultry.
- Allow at least 1" (2.5 cm) space between rotisserie burner and the food.
- To make cleanup easier, place a pan under the food to catch drippings.
- Add barbecue sauce or glaze only during the last 10 minutes of cooking to keep sauce from burning.

#### Trussing Poultry for the Rotisserie

1. Load the spit rod by sliding one of the forks on the rod, with the prongs facing inward. Tighten the screw to keep it from slipping.
2. Push the rod through the center of the bird.
3. Cut 24" (61.0 cm) of butcher's string and center it under the bird, breast side up.
4. Wrap each end of the string around the wings; catch each wing tip. Bring the string tightly together at the top of the breast and knot. It is not necessary to cut off the extra string.
5. Cut another 20" (50.8 cm) of string and lay it under the back of the bird. Wrap it around the tail then around the spit rod, cinching tightly.
6. Cross the legs on top of spit rod; tie string around the crossed legs.
7. Connect the twine holding the legs, to the string holding the wings, and knot. Cut off any bits of hanging string.
8. Slide on the second fork pushing the tines into the drumsticks.
9. Center the food and forks on the rod and tighten the thumb- screws. The bird should be firmly in place on the rotisserie spit rod.

#### Rotisserie Chart

Use a portable meat thermometer to check internal doneness of the food.

Turn off rotisserie burner when meat thermometer reads 5° F/3° C lower than desired internal temperature. Continue rotating, hood closed, for 10 minutes before carving.

Timing is affected by weather conditions such as wind and outside temperature.

Food	Weight	Internal Doneness or Temperature (° F/° C)	Approximate Grilling Time (min/lb)
<b>Beef</b>			
Roasts	4-6 lbs	Medium-rare	15-20
Rib Eye	(1.5-2.2 kg)	(145° F/83° C)	
Sirloin Tip		Medium	20-25
Rib, boneless		(160° F/71° C)	
<b>Poultry</b>			
Chicken	3-6 lbs (1.1-2.2 kg)	Breast	20-25
		(170° F/77° C)	
Turkey, whole	7-10 lbs (2.8-3.7 kg)	Thigh	20-25
		(160° F/82° C)	
Turkey, whole	7-10 lbs (2.8-3.7 kg)	Breast	11-20
		(170° F/77° C)	
Turkey, whole	7-10 lbs (2.8-3.7 kg)	Thigh	11-20
		(160° F/82° C)	
<b>Lamb</b>			
Boneless leg	4-7 lbs (1.5-2.6 kg)	Medium	20-25
		(160° F/71° C)	
<b>Pork</b>			
Loin roast, boneless	4-6 lbs (1.5-2.2 kg)	Medium	20-23
		(160° F/71° C)	

## Grilling Chart

- Knobs have High, Medium and Low settings for flame adjustment.
- Heat settings indicated are approximate.
- Grilling times are affected by weather conditions.
- When 2 temperatures are listed, for example: Medium to Medium-Low, start with the first and adjust based on cooking progress.
- Cooking times may vary from chart times depending on the type of fuel, Natural or LP gas.

FOOD	COOKING METHOD/ BURNER SETTING	INTERNAL TEMP.	TIME (total minutes)	SPECIAL INSTRUCTIONS
<b>Beef</b>				
Hamburgers ½" (1.3 cm) to ¾" (1.9 cm) thick	DIRECT Medium	Medium (160° F/71° C)	10-15	Grill, turning once.
Roasts Rib Eye, Sirloin	INDIRECT Medium/OFF/Medium	Med-Rare (145° F/63° C) to Medium (160° F/71° C)	32-40 per lb. (15-18 per kg)	Tent with foil first 45-60 minutes of cooking time.
Steaks, 1" (2.5 cm) Porterhouse, Rib, T-bone, Top Loin, Sirloin	DIRECT Medium	Med-Rare (145° F/63° C) to Medium (160° F/71° C)	11-16	Rotate steaks Vi turn to create criss-cross grill marks
Steaks, 1½" (3.8 cm) Porterhouse, Rib, T-bone, Top Loin, Sirloin	DIRECT Medium	Med-Rare (145° F/63° C) to Medium (160° F/71° C)	18-25	
Top Round or Shoulder/ Chuck (London Broil) 1½" (3.8 cm) thick	DIRECT Medium	Med-Rare (145° F/63° C) to Medium (160° F/71° C)	22-29	
Flank, ½" (1.3 cm) thick	DIRECT Medium	Med-Rare(145° F/63° C)	11-16	
<b>Pork</b>				
Chops, 1" (2.5 cm) 1½" (3.8 cm) thick	DIRECT Medium to Med-Low	Medium (160° F/71° C)	12-20 30-40	
Ribs 2½-4 lbs (0.9-1.5 kg)	INDIRECT Medium/OFF/Medium	Medium (160° F/71° C)	40-60	Grill, turning occasionally. During last few minutes brush with barbecue sauce if desired. When done, wrap in foil.
Roast, boneless tenderloin, 1lb (0.37 kg)	DIRECT Medium	Medium (160° F/71° C)	18-22	Turn during cooking to brown on all sides.
Ham half, 8-10 lbs (3-3.7 kg)	INDIRECT Med/OFF/Med	Reheat (140° F/60° C)	2-2½ hours	Wrap entire ham in foil and put on grill withough pan or drip pan
Ham steak precooked, ½" (1.3 cm) thick	DIRECT Preheat Medium Grill Medium	Reheat (145° F/63° C)	7-10	
Hot Dogs	DIRECT Medium	Reheat (145° F/63° C)	5-10	Slit skin if desired.
<b>Chicken</b>				
Breast, boneless	DIRECT Medium	170° F/77° C	15-22	For even cooking, pound breast to ¾" (2.0 cm) thick.
Pieces, 2-3 lbs (0.75-1.1 kg)	DIRECT Med-Low to Medium	Breast 170° F/77° C Thigh 180° F/82° C	18-25	Start bone side down.
<b>Lamb</b>				
Chops and Steaks, Loin, Rib, Sirloin, 1" (2.5 cm) thick	DIRECT Medium	Med-rare (145° F/63° C) to Medium (160° F/71° C)	10-20	
1½" (3.8 cm) thick	DIRECT Medium	Med-rare (145° F/63° C) to Medium (160° F/71° C)	16-20	

<b>FOOD</b>	<b>COOKING METHOD/ BURNER SETTING</b>	<b>INTERNAL TEMP.</b>	<b>TIME (total minutes)</b>	<b>SPECIAL INSTRUCTIONS</b>
<b>Fish and Seafood</b>				
Fillets, Steaks, Chunks Halibut, Salmon, Swordfish, 8 oz (0.25 kg)	DIRECT Medium		4-6 per ½" (1.3 cm) thickness of fish	Grill, turning once. Brush grill with oil to keep fish from sticking. Remove when inside is opaque and flaky with skin easily removed.
Whole, Catfish, Rainbow Trout, 8-11 oz (0.25-0.34 kg)	DIRECT High		5-7 per side	
Shellfish, Scallops, Shrimp	DIRECT Medium		4-8	
<b>Turkey</b>				
Whole breast (bone-in)	INDIRECT HI/OFF/High	170° F/77° C	14-18 per lb. (7-8 per kg)	Tent with foil until last 30 minutes of cooking time.
Half breast (bone-in)	INDIRECT Medium/OFF/Medium	170° F/77° C	25-30 per lb (11-13 per kg)	Start skin side down.
Whole, 7-12 lbs (2.6-5.4 kg)	INDIRECT HI/OFF/HI	Breast 170° F/77° C Thigh 180° F/82° C	11-16 per lb (5-7 per kg)	Less than 11 lbs (5.0kg)
<b>Fresh Vegetables</b>				
Corn on the cob	DIRECT Medium		20-25	Soak in cold water 20 minutes. Do not husk. Shake off excess water.
Eggplant	DIRECT Medium		7-10	Wash and cut into ½" (1.3 cm) slices or lengthwise. Brush with olive oil.
Onion, ½" (1.3 cm) thick	DIRECT Medium		8-20	Grill, turning once. Brush with olive oil. Put a skewer through several slices to hold together.
Potatoes, Sweet, whole	DIRECT Medium		40-70	Individually wrap in heavy- duty foil. Grill, rotating occasionally.
Baking, whole	DIRECT High		45-90	
Peppers, Roasted	DIRECT High		15-22	Wash and place on grill whole. Char skin all around. Cool in a paper bag or plastic wrap to loosen blackened skin. Peel and remove seeds.
Squash, Summer, Zucchini	DIRECT Medium		7-10	Wash and cut into ½ (1.3 cm) slices or lengthwise. Brush with olive oil.
Garlic Roasted	DIRECT Medium		20-25	Cut off top, drizzle with olive oil and wrap in double layer of foil

---

# OUTDOOR GRILL CARE

---

## Replacing the Igniter Battery

If igniters stop sparking, the battery should be replaced.

1. The igniter button cap is located on the outside of the grill's right side panel.
2. Unscrew igniter button cap counterclockwise to remove.

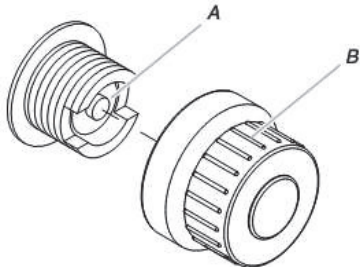

A. "AA" size battery  
B. Igniter cap

3. Remove battery from the battery compartment.
4. Replace with a new alkaline "AA" size battery. Install battery with negative end in first.
5. Screw igniter button cap clockwise into place.

---

## General Cleaning

**IMPORTANT:** Before cleaning, make sure all controls are off and the grill is cool. Always follow label instructions on cleaning products.

For routine cleaning, wash with soap and water using a soft cloth or sponge. Rinse with clean water and dry at once with a soft, lint-free cloth to avoid spots and streaks.

Do not use steel wool to clean the grill, as it will scratch the surface.

To avoid weather damage to finish, use grill cover.

---

### STAINLESS STEEL

**IMPORTANT:** To avoid damage to stainless steel surfaces, do not use soap-filled scouring pads, abrasive cleaners, cooktop polishing creme, steel wool, gritty wash cloths or paper towels. Cleaner should not contain chlorine. Damage may occur.

Food spills should be cleaned as soon as entire grill is cool. Spills may cause permanent discoloration.

#### Cleaning Method:

- Rub in direction of grain to avoid scratching or damaging the surface.
- Stainless steel cleaner.
- Liquid detergent or all-purpose cleaner.
- Rinse with clean water and dry with soft, lint-free cloth.
- Vinegar to remove hard water spots.
- Glass cleaner to remove fingerprints.

---

### GRILL GRATES

**IMPORTANT:** Immediately after you are finished cooking, turn all burners to HIGH for 10-15 minutes with the hood closed to burn off food residue. Turn off all burners, raise the hood and let the grates cool. When completely cool, grill racks can be removed for thorough cleaning. Clean them with a mild detergent and warm water. For baked-on food residue, prepare a solution of 1 cup (240mL) ammonia to 1 gal. (3.75 L) water. Soak grates for 20 minutes, then rinse with water and dry completely.

---

### WARMING SHELF

#### Cleaning Method:

- Liquid detergent or an all-purpose cleaner.
- Rinse with clean water and dry with soft, lint-free cloth.
- For tough spots or baked-on grease, use a commercial degreaser.

**IMPORTANT:** Make sure gas supply is off and all control knobs are in the "OFF" position.

---

### EXTERIOR

The quality of this material resists most stains and pitting, providing that the surface is kept clean, polished and covered.

#### Cleaning Method:

- Apply stainless steel polish to all non-cooking areas before first use. Reapply after each cleaning to avoid permanent damage to surface.
- Cleaning should always be followed by rinsing with clean warm water. Wipe the surface completely dry with a soft cloth.
- For tough spots or baked-on grease, use a commercial degreaser stainless steel.

---

### INTERIOR

Discoloration of stainless steel on these parts is to be expected, due to intense heat from the burners. Always rub in the direction of the grain. Cleaning should always be followed by rinsing with clean, warm water.

#### Cleaning Method:

- Liquid detergent or all-purpose cleaner.
- Rinse with clean water and dry completely with a soft, lint-free cloth.
- A heavy-duty scrub sponge can be used with mild cleaning products.
- For small, difficult-to-clean areas, use a commercial degreaser designed for stainless steel.



---

## BURNERS

---

### Cleaning Method:

- Clean the exterior of the burner with a wire brush.
  - Clear any clogged burner ports with a straightened paper clip.
  - Do not use a toothpick as it may break off and clog the port.
  - Check and clean burner/venturi tubes.
1. Remove grill grates and flame tamers.
  2. Remove the 2 screws and cotter pin that hold the burner in place. Remove gas burner from the grill.

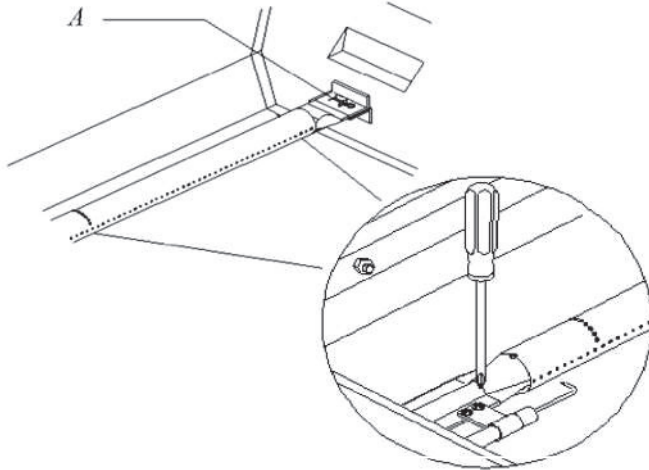

A. Clip

3. Use a flashlight to inspect into the burner through the burner inlet to ensure there is no blockage. If any obstruction is seen, use a metal coat hanger that has been straightened to clear them.
4. After inspecting the inside of burner for blockage, reassemble burner by sliding the middle tube of the gas burner over the gas orifice.

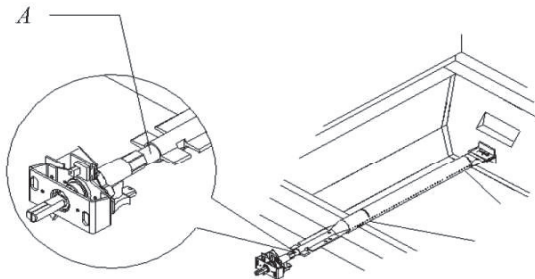

A. Burner/orifice connection

5. Reattach gas burner using screw.

---

## ROTISSIERE BURNER

---

### Cleaning Method:

1. Light the rotisserie burner. See the “Using Your Rotisserie Burner” section.
2. Close the grill hood.
3. Leave the burner on high for approximately 30 minutes.
4. Turn knob to OFF and let cool completely.
5. Brush off ash particles from the rotisserie burner.

---

## GREASE CUP

---

**IMPORTANT:** The grease cup should only be removed when grill is completely cool.

The grease cup collects grease and food particles that fall through the grill. Clean often to avoid grease buildup.

### Cleaning Method:

- Remove the grease cup.
- Wipe excess grease with mild detergent and warm water using paper towels.
- Rinse and dry thoroughly.
- Replace grease box.

---

## KNOBS AND FLANGE AREA AROUND KNOBS

---

**IMPORTANT:** To avoid damage to knobs or flange area around knobs, do not use steel wool, abrasive cleaners, or oven cleaner.

Do not soak knobs.

### Cleaning Method:

- Mild detergent, a soft cloth and warm water.
- Rinse and dry.

---

## CONTROL PANEL GRAPHICS

---

**IMPORTANT:** To avoid damage to control panel graphics, do not use steel wool, abrasive cleaners or oven cleaner. Do not spray cleaner directly onto panel.

### Cleaning Method:

- Clean around the burner labels gently; scrubbing may remove printing.
- Mild detergent, soft cloth and warm water.
- Rinse and dry.