

# SPICE DRAWER INSERT

## Installation Instructions

*Inspect all parts and read all instructions prior to beginning assembly and installation.*

### Parts Included

A. Spice Drawer Insert

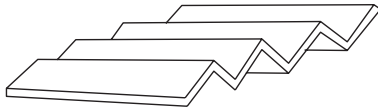

A

### Tools Required

- Tape Measure
- Handsaw
- Sandpaper
- Pencil

### Product Assemblies

SDG-1088

SDG-5800

**Step 1** Measure inside dimensions of the drawer into which the insert will fit. Subtract 1/16" from the width and depth.

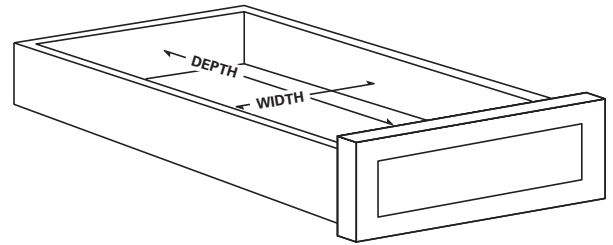

step 1

**Step 2** Transfer the dimensions to the insert. Trim length and depth using a fine tooth handsaw and cutting at a low angle. Smooth any rough edges by using sandpaper along the edges. Place insert in drawer. Installation is now complete.

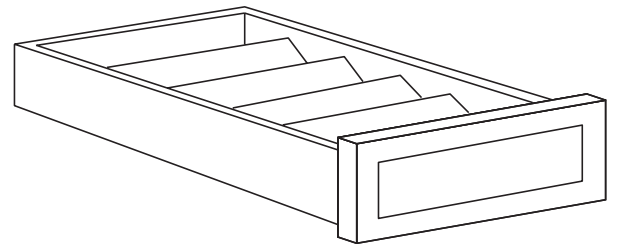
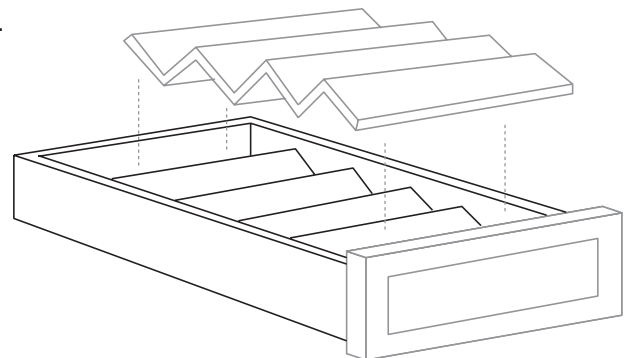

step 2



**Real Solutions**  
For Real Life.™

**KNAPE & VOGT MANUFACTURING COMPANY**

P.O. Box 191, Muncie, IN 47308

0.899.6535 • 765.288.8730 • Fax 765.288.0851 • www.kv.com

RN-216EFS 03/03

## Liste des pièces

. Insert de tiroir à épices

## Lista de partes

. Organizador para gaveta de especias

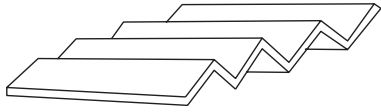

A

## Outils indispensables

Mètre en ruban  
Scie égoïne  
Papier de verre  
Crayon

## Herramientas necesarias

Cinta métrica  
Sierra de mano  
Papel de lija  
Lápiz

## Assemblages

### Ensamblaje de productos

DG-1088

DG-5800

## NOTICE DE MONTAGE

### Insert de tiroir à épices

*Inspectez toutes les pièces et lisez toutes les instructions avant de procéder à l'assemblage et à l'installation.*

#### Étape 1

Mesurez les dimensions internes du tiroir dans lequel l'insert va être introduit. Soustrayez 1,6 mm (1/16 in.) en largeur et en profondeur.

#### Étape 2

Transférez les dimensions sur l'insert. Rognez la longueur et la profondeur à l'aide d'une scie égoïne à dents fines et découpez selon un angle faible. Polissez les aspérités au papier de verre le long des bords. Placez l'insert dans le tiroir. L'installation est terminée.

## INSTRUCCIONES DE INSTALACIÓN

### Organizador para gaveta de especias

*Inspeccione todas las piezas y lea todas las instrucciones antes de comenzar con el armado y la instalación.*

#### Paso 1

Mida las dimensiones interiores de la gaveta a la cual se acomodará el organizador. Reste 0.16 cm. de la suma del ancho y de la profundidad.

#### Paso 2

Trasfiera las dimensiones al organizador. Corte los lados del largo y de la profundidad usando una sierra de mano fina. Debe cortarlo a un ángulo pequeño. Alise los bordes ásperos usando papel de lija por las orillas. Coloque el organizador en la gaveta. La instalación en este punto está completa.

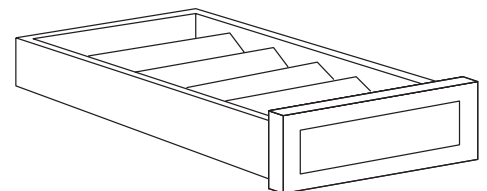
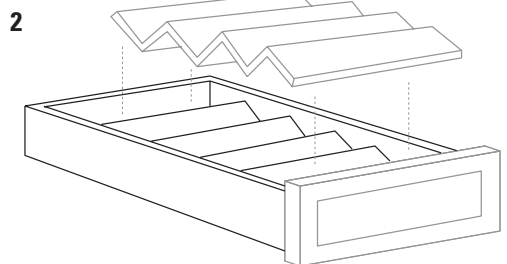
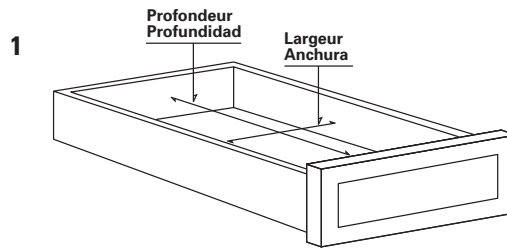

Real Solutions  
For Real Life.™

KNAPE & VOGT MANUFACTURING COMPANY

P.O. Box 191, Muncie, IN 47308

.899.6535 • 765.288.8730 • Fax 765.288.0851 • www.kv.com