

FULL LINE PRODUCT CATALOG



**STRONGER
THAN STEEL.™**

INTERIOR FRAMING • EXTERIOR FRAMING • FLOOR FRAMING
INTERIOR FINISHING • METAL LATH/ACCESSORIES • CLIPS/CONNECTORS

FULL LINE



THE INDUSTRY'S MOST
COMPLETE
PRODUCT LINEUP.
AIMED AT CHANGING THE
BUILDING LANDSCAPE.

Comprehensive is the word. On the following pages, you'll find all things ClarkDietrich. Framing for drywall, curtain wall, doors, windows and floors. Connectors, lath, beads and trim. Bridging, bracing and backing. The list of our products goes on, but there's much more to it than that.

We refer to ourselves as ClarkDietrich Building Systems for a reason. The future of building will be shaped by the inter-relationships of various products and the thinking behind them. Because of this, we create cold-formed steel building products that compose systems—systems backed by intelligent design tools and fully capable engineering services.

This systems approach means our products work better together in achieving strength, fire and sound ratings. It's also an approach that leads to enhanced performance on the job—during installation and long after.

We can reinforce your efforts to design and build more intelligently with a versatile engineering services team and smarter installation and design techniques. Furthermore, we offer the efficiencies of a single supplier with unmatched reach through 14 plants and 5 engineering offices—as well as nationwide product availability. This availability includes the expansive product lineup of accessory leader, Vinyl Corp., a wholly owned subsidiary and forward-thinking ally of ClarkDietrich.

Regardless of your project's size or complexity, ClarkDietrich has the resources to help you achieve your vision. And this comprehensive, full line catalog is a great start. Here you'll find select details about every product in our portfolio, including key advantages and technical information, to guide your specifications.

At the end of the day, a full product line is only as strong as the company that stands behind it. You can count on the expertise, service and full support of ClarkDietrich now, and far into the future.

Need help with product selection, ordering, scheduling, delivery, or anything else?
Call us at **800-543-7140**, or on the West Coast at **800-365-5284**.

Need Product Submittals? Use [SubmittalPro](#)® at [clarkdietrich.com](#).

FULL LINE



TABLE OF CONTENTS

Overview	1-8
Engineering Services	4
Clip Express™	4
Contact Information & Locations	5
How To Use This Catalog	6-7
LEED® and Sustainability	8
Interior Framing	9-33
Drywall Framing	10-14
Sound-Rated Systems	15-18
Head-of-Wall Deflection Systems	19-20
Door and Window Framing	21-23
Bridging, Bracing and Backing	24-27
Shaftwall	28-31
Area Separation Wall	32-33
Exterior Framing	34-49
Curtain Wall Framing	35-37
Door and Window Framing	38-41
Head-of-Wall Deflection Systems	42-45
Bridging and Bracing	46-48
Load-Bearing	49
Floor Framing	50-55
Interior Finishing	56-70
Paper-Faced Beads and Trims	57-59
Metal Beads and Trims	60-64
Vinyl Beads and Trims	65-70
Metal Lath and Accessories	71-86
Metal Lath	72-75
Corner and Casing Beads	76-77
Control and Expansion Joints	78-79
Weep and Sill Screeds	80-81
Veneer Plastic Beads and Trims	82-83
Vinyl Corner and Casing Beads	84
Vinyl Expansion Control Joints	85
Vinyl Weep and Sill Screeds	86
Clips and Connectors	87-104
Curtain Wall and Bypass Connections	88-89
Head-of-Wall Deflection Connections	90
Rigid Connections	91-94
Bridging, Bracing and Backing	95-97
Gusset Plates	98
Floor Joist Framing Connections	99-100
Roof and Truss Connections	101-102
Specialty Clips and Connectors	103-104
Index	105-107
Trademarks and Warranty	108
Code Approvals	109

Support and Services

CLARKDIETRICH ENGINEERING SERVICES

**Smarter engineering and technical expertise.
It's support that extends beyond the structure itself.**

From the initial design phase to jobsite installation, we are all about providing inventive, yet practical and hands-on know-how to help you think outside the box—or to help you just get it done.

ClarkDietrich Engineering Services is a full-service consulting firm that believes strongly in value engineering and customer input. Our engineering fees and lead times are competitive, and our customer service exceeds the industry standard with consistent point-of-contact through our regional project managers.

We offer Building Information Modeling (BIM) services that include specialty engineering collaborative design. We support the BIM movement by offering add-on tools that allow our products, and the rich data attached to them, to quickly be imported into digital designs. Our team is also comprised of LEED®-certified professionals to consult on sustainable building design.

- Electronically sealed shop drawings and calculations
- Preliminary sizing and pre-bid engineering pricing
- Reference plan on large projects
- Detailed wall sections, full elevation opening design and C-stud truss design

Our technical services team provides immediate response to questions ranging from general installation to detailed specification requirements, and can deliver one-day turnaround on technical sizing. We are experts on industry standards such as AISI and ASTM, and a proud member of SFIA. Our team also supports our online product submittal system, SubmittalPro®, and our design/engineering software is available as a free download from www.clarkdietrich.com.

- Product support and typical member sizing
- Framing detail recommendations
- Compliance and industry standards, such as AISI, ASTM and SFIA
- Engineering software and product submittal support
- LEED requirements support

CLIP EXPRESSSM

Connections you can count on.

We know that having the right products, at the right time, and at the right price, is absolutely essential to getting the job done. ClarkDietrich Clip Express is your single source for the widest and most cost-effective array of rigid, deflection, bridging and general-purpose clips, connectors, supports and framing hardware for commercial and residential light-gauge steel framing.

With Clip Express, you get fully engineered, rigorously tested and precision-formed connectors each and every time. Many of our connectors were developed by, or in conjunction with, framing installers in order to deliver high-performance products for significant installed savings.

While you may find a cheaper price than ClarkDietrich, you won't find a lower overall cost or better value. We offer unmatched reach through numerous plants and engineering offices—and nationwide product availability.

And because staying on schedule is crucial, we ship most orders the same day they are received. We'll get it there when, how and where you need it. Our nationwide manufacturing and service facilities see to that.

- Industry's widest product selection available from one source
- Fast delivery options meet your deadlines
- Backed by the largest light-gauge framing and engineering company in the world
- Expert field representatives for comprehensive product, installation and sales training



Throughout this catalog, when you see this icon next to a product entry, you know the product is part of our Clip Express program.

Contact Information and Locations

**Our nationwide presence means we're there for you.
On any project.**

With 14 manufacturing plants and 5 engineering offices strategically located throughout the U.S., ClarkDietrich is always nearby. You can be assured that your product will be delivered on time, and that you can call on us for support any and every step of the way.



ClarkDietrich Building Systems Manufacturing and Sales Locations:

- | | |
|--|---|
| CALIFORNIA Riverside
P 951.360.3500
F 951.360.3333 | KANSAS Lenexa
P 800.659.0745
F 513.645.0750 |
| CALIFORNIA Sacramento
P 951.360.3500
F 951.360.3333 | MARYLAND Baltimore
P 410.477.4000
F 410.477.1550 |
| CONNECTICUT Bristol
P 866.921.0023
F 860.584.6899 | OHIO Warren-East
P 330.372.5564
F 330.372.4055 |
| FLORIDA Dade City
P 352.518.4400
F 352.518.4450 | OHIO Warren-West
P 330.372.4014
F 330.372.1945 |
| GEORGIA McDonough
P 678.304.5500
F 678.304.5555 | TEXAS Baytown
P 281.383.1617
F 281.573.1679 |
| HAWAII Kapolei
P 951.360.3500
F 951.360.3333 | TEXAS Dallas
P 214.350.1716
F 214.350.7252 |
| ILLINOIS Rochelle
P 800.659.0745
F 513.645.0750 | Florida Miami
Vinyl Corp.
P 800.648.4695
F 305.477.4108 |

- Carlsbad, CA
- Riverside, CA
- Sacramento, CA
- Bristol, CT
- Dade City, FL
- McDonough, GA
- Roswell, GA
- Kapolei, HI

- Rochelle, IL
- Crown Point, IN
- Lenexa, KS
- Baltimore, MD
- Warren, OH
- Baytown, TX
- Dallas, TX
- West Chester, OH

ClarkDietrich Engineering Services

Toll-Free Phone: 877.832.3206
 Toll-Free Fax: 877.832.3208
 Email: engineering@clarkdietrich.com
 Technical Services: 888.437.3244

- | | |
|--------------------------------|------------------------------|
| CENTRAL Crown Point, IN | SOUTHEAST Roswell, GA |
| NORTHEAST Bristol, CT | WEST Carlsbad, CA |
| SOUTHEAST McDonough, GA | |

- Manufacturing, engineering and technical services
- ★ Corporate office
- Vinyl Corp.

How To Use This Catalog

This catalog is designed to help you select the right products or systems for your construction applications. Divided into six major sections, it is the most comprehensive manual in the industry.

For your convenience, a comprehensive index containing our complete product and system offering is also located at the back of the catalog. Search by common names and product names to help you quickly find exactly what you're looking for.

Structural properties and load tables are available on our website at clarkdietrich.com.

HOW TO IDENTIFY OUR PRODUCTS

ClarkDietrich has adopted standard nomenclature established by the American Iron and Steel Institute (AISI) for identifying each of its products. Coding of each member consists of four parts, in this order:

- A number which identifies the web depth of the member to two decimal places: 600 = 6.00", 1000 = 10.00", 550 = 5.50", 362 = 3.625", etc.
- A letter that identifies the type of member, such as S = Stud/Joist, T = Track, U = U-channel, and F = Furring channel.
- A number that defines the flange dimension in inches to two decimal places: 162 = 1.625", 200 = 2.00", 125 = 1.25", etc.
- A number following a hyphen that denotes the minimum delivered thickness in mils (33mils = 33/1000 inches which is approximately 0.0329"). Minimum delivered thickness is 95% of design thickness.

NOTE REGARDING PRODUCT SUBSTITUTION

Care should be taken when substituting materials in place of ClarkDietrich building materials. There is a misconception within the construction industry regarding the substitution of one manufacturer's products or materials for those of another manufacturer. The assumption is that all studs of a given size and steel thickness are interchangeable. It may be possible that the substitution can safely be made, but the decision should not be made until the structural properties of the products or materials involved are compared by a qualified engineer.

YIELD STRENGTH (FY/PSI OR KSI)

ClarkDietrich products are manufactured with steel having a yield point of 33ksi for 18 and 20 gauge material. A yield point of 50ksi is standard for 16 gauge and heavier material. KSI = kips/square inch; kip = 1,000 lbs.

PROTECTIVE COATINGS

ClarkDietrich offers a wide variety of protective coatings to meet the specific requirements of a project.

Non-structural products are coated to meet the minimum requirements of ASTM C645, with a G40 or a protective coating with an equivalent corrosion resistance including coatings listed in Table 1 of ASTM A1003. Performance coatings meet the metallic equivalency requirement of C645 by satisfying section 9.1.3 of ASTM A1003 (75 hours in an ASTM B117 salt spray test). Non-structural products may also be ordered with enhanced coatings for special applications.

Structural framing products are available with a variety of protective coatings that meet the CP60 coating protection level requirements of AISI S200 and ASTM C955. These coatings may include G60, A60, AZ50 or GF30, all of which satisfy the above referenced standards. G90 coatings are an enhanced option that can be requested for highly corrosive environments. ClarkDietrich can supply a specific or enhanced coating to meet specific project requirements when requested. The buyer is solely responsible to assure that product is ordered to properly satisfy the applicable code or specification.

STEEL THICKNESS

The steel thickness of a product or component is referenced in terms of gauge or mils. The mil thickness measures the uncoated base metal material, and is a key contributor to the strength of the product.

Note: All products comply with ASTM standards and federal specifications as shown in the Code Approvals and Performance Standards in the back of this catalog. Minimum thickness is 95% of the design thickness, per AISI code. One mil is equivalent to 1/1000 (0.001) of an inch. So, a 20 gauge stud measuring the minimum uncoated base metal at 0.030 inches is 30mils thick.

ClarkDietrich thickness identification by color coding

Member mils	Thickness gauge	Design thickness	Min. thickness	Color code
18	25	0.0188"	0.0179"	None
27	22	0.0283"	0.0269"	Black
30	DW20	0.0312"	0.0296"	Pink
33	20	0.0346"	0.0329"	White
43	18	0.0451"	0.0428"	Yellow
54	16	0.0566"	0.0538"	Green
68	14	0.0713"	0.0677"	Orange
97	12	0.1017"	0.0966"	Red
118	10	0.1242"	0.1180"	Blue

ClarkDietrich ProSTUD® Drywall framing system thickness

Member gauge	Mils	ksi	Design thickness	Min. thickness	Color code
ProSTUD 25	15	70	0.0158	0.0150	None
ProSTUD 20	19	65	0.0200	0.0190	Pink
ProSTUD 30	30	33	0.0312	0.0300	White
ProSTUD 33MIL	33	33	0.0346	0.0329	White

ProTRAK 25 and 20 = 50ksi ProTRAK 30mil and 33mil = 33ksi

PRODUCT LABELING

Skids are easily identified with master skid labels that display product, gauge, size, length, piece count, yield strength and any special skid markings specified at the time of order. Individual inkjet labeling (including company name, product, size, length, gauge, coating and yield strength) or embossing is also provided on many of our structural framing members. UPC bar coding is also available for certain products.

METRIC SPECIFICATIONS

At your request, ClarkDietrich will provide “soft” metric conversions on its products and systems to help specifiers match metric design sizes. In addition, some products are available with hard metric dimensions from selected manufacturing facilities.

STANDARDS & SPECIFICATIONS

All structural properties are developed in accordance with the American Iron and Steel Institute’s “Specification for the Design of Cold-Formed Steel Structural Members.”

GENERAL NOTES

The data contained in this catalog is intended to be used as a general guideline only and does not replace the judgments and designs of a qualified architect and/or engineer. This catalog does not provide load data necessary for building design. Load capacities, limiting heights, physical and structural properties and span data for ClarkDietrich structural framing can be found at www.clarkdietrich.com.

Product, application renderings and photographs are provided as a tool to show the general intent of the framing or finishing application only. These renderings or photographs may or may not be applicable to a specific project. They do not replace or supersede the architect or engineer of record, ASTM guidelines, national or local building codes or approved industry standards.

ClarkDietrich Building Systems reserves the right to change or modify the information contained in this catalog without prior notice or obligation. The information in this catalog supersedes all previously published data. Products and systems may be improved and/or changed after this catalog is printed.

PRODUCT AVAILABILITY

Most products manufactured by ClarkDietrich are readily available in all markets, but there can be exceptions. Please contact your ClarkDietrich Sales Representative to make sure the product you need is available in your market area.



ClarkDietrich is a proud member of the Steel Framing Industry Association (SFIA).

ClarkDietrich LEED® INFORMATION AND REQUIREMENTS

ClarkDietrich
LEED Request Form
online at clarkdietrich.com

The future of building is all about the future of the environment.

ClarkDietrich products are manufactured from 100% recyclable cold-formed steel and contain both pre- and post-consumer recycled content. Steel is infinitely durable, providing strength throughout the lifetime of the structure. Due to our nationwide manufacturing locations, our products are often within a 500 mile radius of your project. But most importantly, our LEED®-certified professionals offer advanced knowledge of sustainable building practices. Which can help sustain your business.

LEED Credit MR 2 (Construction Waste Management)

ClarkDietrich products are manufactured from cold-formed steel. Steel is 100% recyclable. This attribute can help when diverting construction debris from the waste stream. Recycling construction waste contributes to LEED Credits MR 2.1 and 2.2. The specific contribution will vary by project and must be determined by the contractor. (Up to 2 pts.)

LEED Credit MR 4 (Recycled Content)

ClarkDietrich's steel products have a minimum of 25.5% for post-consumer recycled content, and 6.8% pre-consumer. Recycled content of materials contributes to LEED Credits MR 4.1 and 4.2, and possibly an Innovation in Design Credit if the project's overall recycled content exceeds 30%. While ClarkDietrich, nationwide, has an average recycled content of 48%, we recommend using the default number of 25.5% post-consumer and 6.8% pre-consumer for your project calculations. If a higher content is desired, ClarkDietrich can provide this information if mill certifications are requested at time of order. (Up to 3 pts.)

LEED Credit MR 5 (Regional Materials)

LEED Credit MR 5 requires the jobsite to be within a 500 mile radius of the manufacturing plant and from the point of extraction of raw materials. With nationwide manufacturing locations, ClarkDietrich plants, as well as our steel sources, often fall within the required 500 mile radius. Each product must be tracked from the mill to the project location and then these values must be weighted by recycled content percentages. If you wish to report MR 5 Credits, please submit a LEED request through clarkdietrich.com or contact ClarkDietrich Technical Services at 888-437-3244 for procedures. (Up to 2 pts.)

ClarkDietrich Building Systems

ClarkDietrich Building Systems, Inc. is an active member of the U.S. Green Building Council with LEED Accredited Professionals on staff. ClarkDietrich is committed to supplying quality products and continually looking for new ways to develop greener building products and sustainable business practices. In total, ClarkDietrich products can help your project qualify for up to 7 LEED Credits under LEED for New Construction and Major Renovations (LEED-NC Ver. 2.2 and 3.0).



ClarkDietrich plant locations:

Riverside, CA
Sacramento, CA
Bristol, CT
Dade City, FL

McDonough, GA
Kapolei, HI
Rochelle, IL
Lenexa, KS

Baltimore, MD
Warren, OH
Baytown, TX
Dallas, TX

INTERIOR FRAMING

Interior framing that stands up to any test. Including yours.

The inherent properties of steel make it a superior alternative to wood for interior framing: it's light, strong, versatile and noncombustible. With corrosion-resistant coatings, steel also adds durability and sustainability to your buildings. All of which means that steel is a perfect solution for a variety of nonload-bearing applications, such as partition walls, ceilings and column fireproofing in all types of low- to high-rise commercial structures—as well as residential dwellings.

At the heart of our interior framing line is our ProSTUD® Drywall Framing System. It's not only been extensively field-tested for quality and ease of installation, but it also features a number of technological advances to enhance strength and versatility.

ClarkDietrich truly stands alone as a single source for a full range of interior framing products.

- Cost-effective, labor-saving solutions
- Drywall, shaftwall, and area separation wall
- Door and window framing solutions
- Sound-rated systems
- Head-of-wall deflection systems
- Bridging, bracing and backing
- Absolute code compliance



ProSTUD® Drywall Framing System

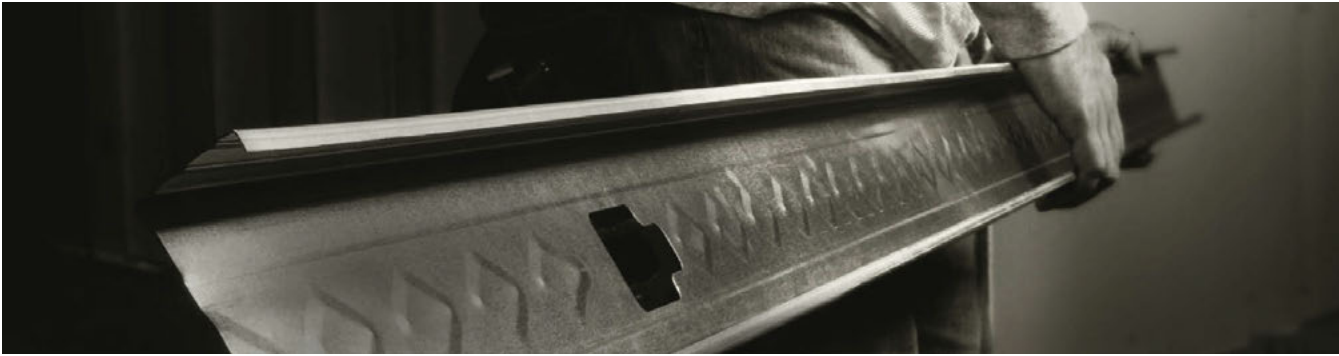

Developed, tested, and approved by pros—in the field.

The ProSTUD® Drywall Framing System can be called many things. Strong. Versatile. Fast. And without a doubt—revolutionary. But it was also developed, tested and approved by pros in the field who demanded nothing less than achieving absolute ease of use. Its performance has also been proven by the most extensive laboratory evaluations available.

THE INDUSTRY'S PRODUCT OF CHOICE

Gauge equivalent (EQ) drywall framing must meet the minimum performance requirements of conventional drywall framing as defined by the Steel Framing Industry Association (SFIA) and the Steel Stud Manufacturers Association (SSMA). For interior drywall framing members, bending strength (or allowable moment) is the criteria most important to the strength of a wall or ceiling. ProSTUD employs modern roll-forming and steel-making technology that enhances the shape and strength with greater efficiency. ProSTUD—the product of choice—exceeds the performance of conventional drywall framing for allowable moment and screw connection strength.

LIFE SAFETY

Life Safety is the primary concern and duty of all construction and design professionals. ProSTUD features a number of technological advances to enhance its stiffness and strength, contributing to its allowable moment performance. When it comes to fire-rated systems, ProSTUD is UL-approved for the most common UL design assemblies including V450, U419, V438 and chase wall assemblies.

SOUND PERFORMANCE

ProSTUD also has exceptional sound performance in over 50 tested sound assemblies—more testing than any other manufacturer in the industry.

ProSTUD Drywall Framing and ProTRAK® Drywall Track were created specifically to work as a system. This means they work better together for you in achieving strength, fire *and* sound ratings. It's also an approach that leads to enhanced performance on the job—during installation and long after.

- High-strength steel combined with low-profile flange stiffening grooves and double offset web planking increases strength and provides greater limiting heights
- Diamond embossed web creates stiffness, reducing flange fade and screw spinout during drywall installation
- Strong, lightweight stud and track cuts and handles easier than conventional flat steel studs
- Flange grooves provide sight line for drywall alignment and aid in positioning screws at drywall joints to maintain the 3/8" edge requirement
- Web and leg enhancements in ProTRAK provide straight and rigid legs, making it the best choice for framing walls, headers, soffits, and bulkheads
- Nationwide availability



ProSTUD®



Product code	Product name	Thickness			ksi	Web width (in)	Flange (in)
		Gauge	Mils	Design thickness (in)			
PROS	ProSTUD 25	25	15	0.0158	50	1-5/8,	1-1/4
	ProSTUD 20	20	19	0.0200	65	2-1/2,	
	ProSTUD 30MIL	20 DW	30	0.0312	33	3-5/8,	
	ProSTUD 33MIL	20 STR	33	0.0346	33	4, 6	

All material G40 EQ (CP60 available as special order).
See other ProSTUD product options at clarkdietrich.com.

ProTRAK®

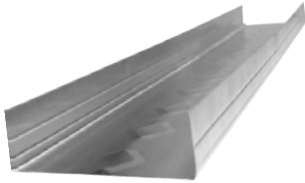

Product code	Product name	Thickness			ksi	Web width (in)	Leg (in)
		Gauge	Mils	Design thickness (in)			
PROT	ProTRAK 25	25	15	0.0158	50	1-5/8,	1-1/4,
	ProTRAK 20	20	19	0.0200	50	1-1/2,	1-1/2,
	ProTRAK 30MIL	20 DW	30	0.0312	33	3-5/8,	2,
	ProTRAK 33MIL	20 STR	33	0.0346	33	4, 6	2-1/2,
							3

All material G40 EQ (CP60 available as special order).

Allowable Bending Capacity, 3-5/8" Stud

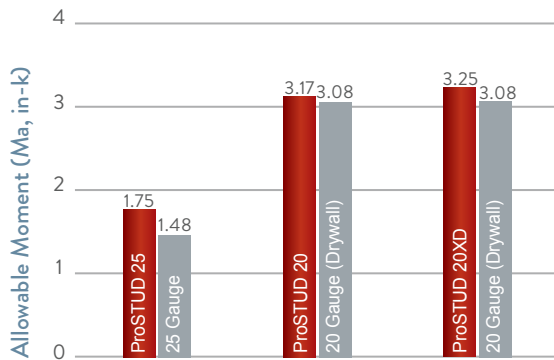

#6 Screw Pullout Values

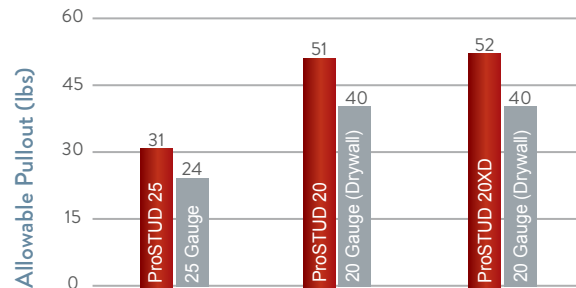

#6 Screw Shear (Bearing) Values

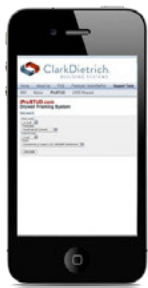
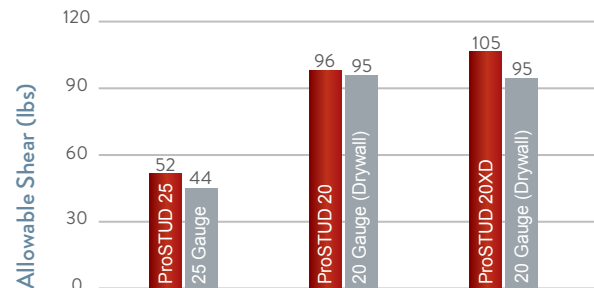

iProSTUD.com

Going mobile? With your smartphone in hand, you can perform a fast, easy search, view ProSTUD limiting heights and even email submittal documents.

Interior Contour Track®

A high-performance solution for intricate, dramatic architecture.

ClarkDietrich Interior Contour Track® flexible framing products are low-cost, high-performance framing solutions for nonload-bearing curves, bends, variable radii and arches for dramatic and distinctive ceilings, walls and bulkheads.

- Easily hand bends or forms to the desired curve, bend, radius or arch
- One product for both curves and arches
- Use with wood or steel studs

Contour Track answers the demands of today’s customers wanting more elaborate and complex contoured architecture including dramatic sweeping soffits and bulkheads, curved or rounded walls, wavy ceilings, barrel vaults, arched and contoured openings, round or oval columns, and elliptical and eyebrow curves.

CONTOUR TRACK® 1-1/4" LEG

Product code	Thickness			Size (in)
	Gauge	Mils	Design thickness (in)	
CNTB	25	18	0.0188	2-1/2
				3-5/8
				6
CETB	20	26	0.0273	2-1/2
				3-5/8
				6

Use only in nonload-bearing applications.

PUNCHED WEBS

Contour Track is permanently locked into place by securing it to the primary supporting structure using the prepunched holes conveniently placed throughout the web.

EXPANDABLE RIBBON TECHNOLOGY

Contour Track flexible framing products feature expandable ribbon technology that expands and contours to your desired curve, bend or radius. The ribbon technology offers curving flexibility, while maintaining or holding its shape during installation.

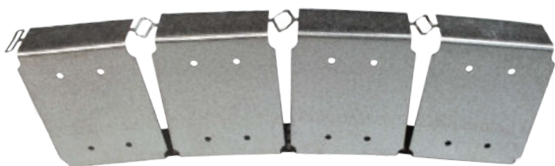

HINGED SUPPORT LEG

The other leg of the ClarkDietrich Contour Track features prepunched, easy-to-cut guide holes when contour track is used in arches or extreme radius conditions like column framing. In these conditions, the ribbons are quickly removed with snips and the trim holes are partially cut to provide maximum flexibility and versatility.

INTERLOCKING TRACK

Contour Track flexible framing members bend both ways and easily form challenging compound curves. S-curves are easily made by overlapping and interlocking one 2" web section. Screw attach, then hand-bend to the desired effect.

IT ALL ADDS UP TO:

Faster, Easier and Safer Installation

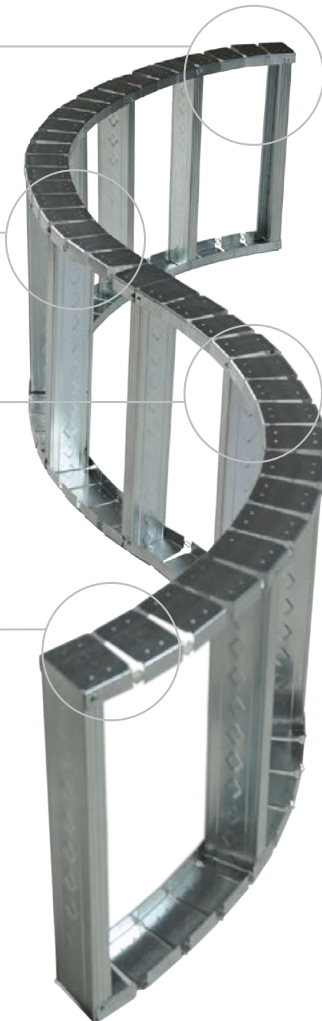

GROMMETS



2-Piece Grommet



Snap-In Bushing

Grommets snap easily into stud knockouts and are used to protect electrical wiring and plumbing lines from contacting metal. Grommets are commonly used in construction when metal conduit is not required by building code.

Product code	Size (in)	Description	Pcs./Carton
GROM	3/4	For 1-5/8" and 2-1/2" studs	100
	1-1/2	For 3-1/2" and wider studs	

CORNER ANGLE



Corner Angle (90°)



Splayed Corner Angle (120°/135°)

Corner angle is a multipurpose 90° or 120°/135° galvanized angle used in dozens of framing applications. Some of the most common applications include lapped framing conditions, soffit framing, floor and ceiling runner, chase wall construction and laminated gypsum drywall partitions. Custom sizes, beads, and lengths are available.

Product code	Thickness			Size (in)	Length (ft)
	Gauge	Mils	Design thickness (in)		
CAN 90°	25	18	0.0188	5/8 x 2	10
				7/8 x 1-3/8	
				1-1/2 x 1-1/2	
				2 x 2	
CANW 135°	25	18	0.0188	3 x 3	10
				1-1/2 x 1-1/2	
HCN (Hemmed) 90°	25	18	0.0188	2 x 2	10
				2 x 2	
CAE 90°	20	30	0.0312	5/8 x 2	10
				7/8 x 1-3/8	
				1-1/2 x 1-1/2	
				2 x 2	
CAEW 135°	20	30	0.0312	3 x 3	10
				1-1/2 x 1-1/2	
				2 x 2	

INTERIOR FRAMING

FURRING CHANNEL CLIP



In a ceiling assembly, furring channel clips can be used to suspend U-channel from the overhead structure. Drywall furring channel is commonly clipped or wire-tied perpendicular to the underside of the U-channel at appropriate intervals for screw-attaching drywall.

Product code	Pcs./Bucket
MFCC	500

Z-FURRING



ClarkDietrich Z-furring is used to furr out interior masonry or poured concrete wall substrates and to support rigid polystyrene, mineral, or fiberglass batt insulation while providing a uniform plane for gypsum panel attachment. Z-furring should be installed vertically with the 3/4" flange against the substrate. The type of fastener and spacing will vary based on application. Install gypsum wallboard parallel or perpendicular to Z-furring.

Product code	Thickness			Size (in)	Length (ft)
	Gauge	Mils	Design thickness (in)		
ZFN1	25	18	0.0188	1	8'-6", 10', 12'
ZFN2				1-1/2	
ZFN3				2	
ZFN4				2-1/2	
ZFE1	20	30	0.0312	1	8'-6", 10', 12'
ZFE2				1-1/2	
ZFE3				2	
ZFE4				2-1/2	

Heavier gauges available on request.

FURRING CHANNEL



7/8" Furring Channel*



1-1/2" Furring Channel*

ClarkDietrich furring channel is a hat-shaped corrosion-resistant framing component used to furr out masonry walls and ceiling assemblies. In concrete wall applications, furring channel is installed vertically to the wall surface using concrete nails or powder-driven fasteners. Gypsum panels are then screw-attached to the furring channels. In ceiling applications, furring channels can be attached directly to the underside of the building structure using tie wire, screws or powder-driven fasteners.

Product code	Thickness			Size (in)	Length (ft)
	Gauge	Mils	Design thickness (in)		
FCN	25	18	0.0188	7/8	10', 12'
FCE	20	30	0.0312		
FCM	18	43	0.0451		
FCM	16	54	0.0566		
FCND	25	18	0.0188	1-1/2	10', 12'
FCED	20	30	0.0312		
FCMD	18	43	0.0451		
FCMD	16	54	0.0566		

*Hemmed leg furring channel (as shown) is only available in 25 gauge.

ProSTUD® 3-5/8" SOUND ASSEMBLIES

Gypsum type	Side A	Side B	Insulation type	Stud spacing (in)	STC Rating		Partition type
					ProSTUD 25	ProSTUD 20	
5/8" Type X	1 layer	1 layer	—	24	43	40	1
5/8" Type X	1 layer	1 layer	R-13 unfaced**	24	48	45	2
5/8" Type X	2 layers	2 layers	R-13 unfaced**	24	54	*	5 Similar
5/8" Type X	1 layer	1 layer on RC-Deluxe	R-13 unfaced**	24	52	50	3
5/8" Type X	1 layer	2 layers on RC-Deluxe	R-13 unfaced**	24	59	56	4
5/8" Type X	2 layers	1 layer on RC-Deluxe	R-13 unfaced**	24	57	56	5 Similar
5/8" Type X	2 layers	2 layers on RC-Deluxe	R-13 unfaced**	24	62	61	5
5/8" Type X	1 layer	1 layer on RC-Deluxe	R-13 unfaced**	16	51	*	3
5/8" Type X	1 layer	2 layers on RC-Deluxe	R-13 unfaced**	16	58	*	4
5/8" Type X	2 layers	2 layers on RC-Deluxe	R-13 unfaced**	16	62	*	5
5/8" Type X	1 layer	1 layer on RC-1 PRO	R-13 unfaced**	24	51	50	3
5/8" Type X	1 layer	2 layers on RC-1 PRO	R-13 unfaced**	24	58	56	4
5/8" Type X	2 layers	2 layers on RC-1 PRO	R-13 unfaced**	24	61	60	5
5/8" Hi-impact XP Fire Shield	1 layer	1 layer on RC-Deluxe	R-13 unfaced**	16	55	*	3
	1 layer	2 layers on RC-Deluxe	R-13 unfaced**	16	62	*	4
	2 layers	2 layers on RC-Deluxe	R-13 unfaced**	16	65	*	5
1/2" Regular	1 layer	1 layer on RC-Deluxe	R-13 unfaced**	24	50	*	3
1/2" Regular	1 layer	2 layers on RC-Deluxe	R-13 unfaced**	24	54	*	4
1/2" Regular	2 layers	2 layers on RC-Deluxe	R-13 unfaced**	24	59	*	5

ProSTUD 2-1/2" SOUND ASSEMBLIES

Gypsum type	Side A	Side B	Insulation type	Stud spacing (in)	STC Rating		Partition type
					ProSTUD 25	ProSTUD 20	
5/8" Type X	1 layer	1 layer	-	24	38	*	1
5/8" Type X	1 layer	1 layer	R-13 unfaced**	24	45	*	2
5/8" Type X	1 layer	1 layer on RC-Deluxe	R-13 unfaced**	24	51	49	3
5/8" Type X	1 layer	2 layers on RC-Deluxe	R-13 unfaced**	24	58	56	4
5/8" Type X	2 layers	2 layers on RC-Deluxe	R-13 unfaced**	24	62	59	5

ProSTUD 6" SOUND ASSEMBLIES

Gypsum type	Side A	Side B	Insulation type	Stud spacing (in)	STC Rating		Partition type
					ProSTUD 25	ProSTUD 20	
5/8" Type X	1 layer	1 layer on RC-Deluxe	R-13 unfaced**	24	52	*	3
5/8" Type X	1 layer	2 layers on RC-Deluxe	R-13 unfaced**	24	58	*	4
5/8" Type X	2 layers	2 layers on RC-Deluxe	R-13 unfaced**	24	63	*	5



Partition Type 1

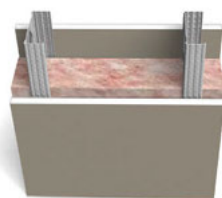

Partition Type 2



Partition Type 3

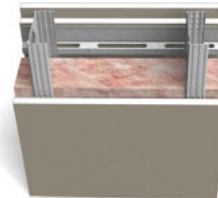

Partition Type 4

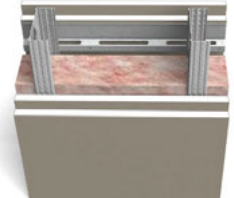

Partition Type 5

*Additional test reports available through ClarkDietrich Technical Services.

**Values are the same for R-11 insulation. Contact Technical Services at 888-437-3244 for additional support information.

Sound assemblies are certified by Western Electro-Acoustic Laboratories.

NVLAP accredited for ASTM E90 & E143, ISO Certified.

See STC test reports for detailed requirements of construction of wall assembly.

Resilient Channels for Walls and Ceilings

ClarkDietrich resilient channel is one of the most efficient low-cost methods developed to reduce transmission of airborne sound through partition and ceiling assemblies. The resilient channel dampens sound waves effectively, dissipating the energy and reducing sound transmission by suspending gypsum wallboard 1/2" from the stud or joist. Sound absorption can be maximized by utilizing sound attenuation blankets within the wall or floor cavity.

- Lab-certified STC-rated up to 61
- Single- and double-leg channels
- Choose from five channels; RC Deluxe™ has extra-wide screw surface for easy attachment
- Available in 12' lengths
- Possible LEED® benefits under IEQ9 due to increased STC values. For more information on our STC assemblies, visit our website at clarkdietrich.com

RC Deluxe™ RESILIENT CHANNEL



Made of 21mil steel, RC Deluxe is one of the most effective, low-cost methods of improving sound transmission loss through wood and steel frame partitions. It is the preferred resilient channel in many applications because of its extra-wide 1-1/2" screw flange.

Resilient channel should be installed perpendicular to the framing members with the attachment flange of the RC Deluxe installed along the bottom edge. Channel is prepunched for screw attachments to wood or steel framing members. Nails are not recommended.

Product code	Thickness			Size (in)	Length (ft)
	Gauge	Mils	Design thickness (in)		
RCSD	25	21	0.0221	1-1/2	12

Sound assemblies are certified by Western Electro-Acoustic Laboratories. NVLAP accredited for ASTM E90 & E413, ISO Certified. Additional test reports available through ClarkDietrich Technical Services. *Values are the same for R-11 insulation.

Gypsum type	Side A	Side B	Insulation type	Stud depth (in)	Stud spacing (in)	STC Rating		STC Rating	
						ProSTUD 25	WEAL test no.	ProSTUD 20	WEAL test no.
5/8" Type X	1 layer	1 layer on RC-Deluxe	R-13 unfaced*	3-5/8	24	52	TL09-542	50	TL09-559
5/8" Type X	1 layer	2 layers on RC-Deluxe	R-13 unfaced*	3-5/8	24	59	TL09-543	56	TL09-560
5/8" Type X	2 layers	2 layers on RC-Deluxe	R-13 unfaced*	3-5/8	24	62	TL09-544	61	TL09-561

RC-1 PRO RESILIENT CHANNEL



Made of 25 gauge steel, RC-1 Pro is used as a cross-furring member for resilient attachment of gypsum. Knurled face makes wallboard application easier.

Resilient channel should be installed perpendicular to the framing members with the attachment flange of the RC-1 Pro installed along the bottom edge. Channel is prepunched for screw attachments to wood or steel framing members. Nails are not recommended.

Product code	Thickness			Size (in)	Length (ft)
	Gauge	Mils	Design thickness (in)		
RCUR	25	18	0.0188	1-1/4	12

Sound assemblies are certified by Western Electro-Acoustic Laboratories. NVLAP accredited for ASTM E90 & E413, ISO Certified. Additional test reports available through ClarkDietrich Technical Services. *Values are the same for R-11 insulation.

Gypsum type	Side A	Side B	Insulation type	Stud depth (in)	Stud spacing (in)	STC Rating		STC Rating	
						ProSTUD 25	WEAL test no.	ProSTUD 20	WEAL test no.
5/8" Type X	1 layer	1 layer on RC-1 Pro	R-13 unfaced*	3-5/8	24	51	TL09-555	50	TL09-564
5/8" Type X	1 layer	2 layers on RC-1 Pro	R-13 unfaced*	3-5/8	24	58	TL09-556	56	TL09-563
5/8" Type X	2 layers	2 layers on RC-1 Pro	R-13 unfaced*	3-5/8	24	61	TL09-598	60	TL09-562

RC-1 ProPlus HEAVY-DUTY RESILIENT CHANNEL



Made of 22mil steel, RC-1 ProPlus is used as a cross-furring member for resilient attachment of gypsum. Knurled face makes wallboard application easier.

RC-1 ProPlus single-leg resilient channel is typically used for applications with multiple layers of

gypsum board. Resilient channel should be installed perpendicular to the framing members with the attachment flange of the RC-1 ProPlus installed along the bottom edge. Channel is prepunched for screw attachments to wood or steel framing members. Nails are not recommended.

Product code	Thickness			Size (in)	Length (ft)
	Gauge	Mils	Design thickness (in)		
RCUR	23	22	0.0232	1-1/4	12

Sound assemblies are certified by Western Electro-Acoustic Laboratories. NVLAP accredited for ASTM E90 & E413, ISO Certified. Additional test reports available through ClarkDietrich Technical Services. *Values are the same for R-11 insulation.

Gypsum type	Side A	Side B	Insulation type	Stud depth (in)	Stud spacing (in)	STC Rating	
						ProSTUD [®] 25	WEAL test no.
5/8" Type X	1 layer	1 layer on RC-1 Pro Plus	R-13 unfaced*	3-5/8	24	53	TL10-504
5/8" Type X	1 layer	2 layers on RC-1 Pro Plus	R-13 unfaced*	3-5/8	24	58	TL10-505
5/8" Type X	2 layers	2 layers on RC-1 Pro Plus	R-13 unfaced*	3-5/8	24	63	TL10-506

RC-2 PRO DOUBLE-LEG RESILIENT CHANNEL



Made of 25 gauge steel, RC-2 Pro double-leg resilient channel is typically used for ceiling applications. It is used as a cross-furring member for resilient attachment of gypsum. Knurled face makes wallboard application easier.

Resilient channel should be installed perpendicular to the framing members. Channel is prepunched for screw attachments to wood or steel framing members.

Product code	Thickness			Size (in)	Length (ft)
	Gauge	Mils	Design thickness (in)		
RCDN	25	18	0.0188	1-1/4	12

Sound assemblies are certified by Western Electro-Acoustic Laboratories. NVLAP accredited for ASTM E90 & E413, ISO Certified. Additional test reports available through ClarkDietrich Technical Services. *Values are the same for R-11 insulation.

Gypsum type	Side A	Side B	Insulation type	Stud depth (in)	Stud spacing (in)	STC Rating	
						ProSTUD [®] 25	WEAL test no.
5/8" Type X	1 layer	1 layer on RC-2 Pro	R-13 unfaced*	3-5/8	24	52	TL10-513
5/8" Type X	1 layer	2 layers on RC-2 Pro	R-13 unfaced*	3-5/8	24	58	TL10-514
5/8" Type X	2 layers	2 layers on RC-2 Pro	R-13 unfaced*	3-5/8	24	62	TL10-515

RC-2 ProPlus HEAVY-DUTY DOUBLE-LEG RESILIENT CHANNEL



Made of 30mil steel to provide a stiffer resilient channel, RC-2 ProPlus heavy-duty double-leg resilient channel is typically used for ceiling applications with multiple layers of gypsum board. It is used as a cross-furring member for resilient attachment of gypsum. Knurled face makes wallboard application easier.

Resilient channel should be installed perpendicular to the framing members. Channel is prepunched for screw attachments to wood or steel framing members.

Product code	Thickness			Size (in)	Length (ft)
	Gauge	Mils	Design thickness (in)		
RCDE	23	22	0.0232	1-1/4	12

Sound assemblies are certified by Western Electro-Acoustic Laboratories. NVLAP accredited for ASTM E90 & E413, ISO Certified. Additional test reports available through ClarkDietrich Technical Services. *Values are the same for R-11 insulation.

Gypsum type	Side A	Side B	Insulation type	Stud depth (in)	Stud spacing (in)	STC Rating	
						ProSTUD [®] 25	WEAL test no.
5/8" Type X	1 layer	1 layer on RC-2 Pro Plus	R-13 unfaced*	3-5/8	24	53	TL10-518
5/8" Type X	1 layer	2 layers on RC-2 Pro Plus	R-13 unfaced*	3-5/8	24	58	TL10-517
5/8" Type X	2 layers	2 layers on RC-2 Pro Plus	R-13 unfaced*	3-5/8	24	62	TL10-516

RESILIENT SOUND ISOLATION CLIP



The RSIC-1® resilient sound isolation clip is used in conjunction with drywall furring channel to fasten gypsum wallboard to various wall and floor-ceiling designs and applications, while simultaneously providing acoustical separation (decoupling). This significantly reduces the amount of impact and sound that filters from surrounding rooms—reducing the noise transfer by 75 to 100%.

Product code	Pcs./Bucket
RSIC-1	200

- UL Classified R16638

U.S. Patent No. 6,267,347 of MTEC, LLC.

The RSIC-1 clip is a registered trademark of MTEC, LLC.

UL and UL Classified are registered trademarks of Underwriters Laboratories, Inc.



Installation of Resilient Furring Channel to Steel or Wood Framing Members

Note: These guidelines are for ClarkDietrich Building System's single leg RC Deluxe™ and RC-1 Pro, and double leg RC-2 Pro. Details of construction for a specific assembly to achieve the required fire or sound or acoustic rating shall be obtained from fire test reports, sound, or acoustic tests, engineering evaluations, or listings from recognized sound or acoustic laboratories.

Install resilient furring channels at right angles (perpendicular) to the framing members. The resilient furring channel shall be positioned with the slotted hole(s) directly over the framing member. The resilient furring channel shall be attached to the framing member using the screw hole provided in the mounting flange. If no screw hole is provided or located at the framing member, attach through the mounting flange.

No more than two layers of up to 5/8 in. (16mm) gypsum panel products should be installed to resilient furring channel.

Resilient furring channels should not be spaced greater than 24 in. (610mm) on-center when installed on wall framing members. For ceiling framing members spaced 24 in. (610mm) on-center, install resilient furring channels at 16 in. on-center maximum. For ceiling framing members spaced 16 in. (406mm) on-center, install resilient furring channels at 24 in. (610mm) on-center maximum.

In the case of wall framing members, resilient furring channels should be installed with the mounting flange of the resilient furring channel down, except at the floor or starter row where the mounting flange may be installed with the flange up, to accommodate fastening to the framing members. In the case of two-legged resilient furring channel, attach only the lower mounting flange to the wall framing members, except as noted.

Note 1: By keeping the mounting flange down, the weight of the gypsum panel products will pull the resilient channel away from the stud improving the sound rating.

Note 2: Two-legged resilient furring channels may be attached to the wall and ceiling framing members using both legs. Alternately attach the legs of the resilient furring channel to the framing members. This method of attachment may reduce the sound rating performance of the assembly. Verify acceptability with the approving authority prior to installation.

For walls, install the first (lowest) row of resilient furring channel no more than 2 in. (51mm) off of the floor and the last (highest) row of resilient furring channel not more than 6 in. (152mm) from the ceiling. For ceilings, the first row and last row of resilient furring channel shall be located not more than 6 in. (152mm) from the adjacent wall. (Measurements are to the center of the face of the resilient furring channel.)

Attach resilient furring channel to framing members with screws only. For steel framing, Type-S x 3/8 in. (9.5mm) pan-head framing screws may be used. For wood framing members, Type-W or Type-S screws (minimum 1-1/4 in. (32mm) long) may be used. It is not recommended that nails be used. Install the screws in the holes provided in the mounting flange (whenever possible).

Splicing of resilient furring channel members shall be done by “nesting” the ends of the resilient furring channel members directly over the framing member and screwing through the mounting flanges into the framing member. (An acceptable alternative would be to butt the resilient furring channel members over the framing member leaving a minimum 1/16 in. (1.6mm) gap between resilient furring channels.)

Gypsum panel products shall be attached to the resilient furring channel using a screw length to ensure that the screw point does not make contact with the framing member. (This will minimize the potential of the screws hitting the wall studs and “short-circuiting” the sound resistance effectiveness of the resilient furring channels.)

HEAD-OF-WALL (H-O-W) DEFLECTION SYSTEMS

It's a real challenge these days meeting head-of-wall codes for fire stop and life safety issues while maintaining the ability to absorb vertical movement in low-, mid- and high-rise buildings. ClarkDietrich has the head-of-wall deflection products and systems you need for interior wall assemblies subjected to movement—including seismic disturbances.

MaxTrak® SLOTTED DEFLECTION TRACK



MaxTrak® is a head-of-wall deflection track that is used for framing exterior curtain walls and nonload-bearing interior walls where vertical deflection occurs—and serves as a connecting member that isolates the cold-formed steel framing system from the movement of the primary structure.

Product code	Thickness			Web width (in)	Leg length (in)	Standard length (ft)
	Gauge	Mils	Design thickness (in)			
MAX	20	33	0.0346	2-1/2	2-1/2	10
				3-5/8		
				4		
				6		
MAX	18	43	0.0451	2-1/2	2-1/2	10
				3-5/8		
				4		
				6		

- Positive attachment with total allowable vertical movement of 1-1/2" (±3/4")
- One-piece system reduces cost of materials and labor
- UL Classified R26034
- IAPMO #0145



SLP-TRK® SLOTTED TRACK



SLP-TRK® slotted track provides a positive attachment for wall strength and allows for vertical movement. Movement caused by normal head-of-wall and floor extension or compression is absorbed by SLP-TRK slotted track to prevent damage to the wall assembly. SLP-TRK slotted track systems comply with the toughest code requirements in North America.

SLP-TRK® is a registered trademark of Brady Construction Innovations.

Product code	Thickness			Web width (in)	Leg length (in)	Standard length (ft)
	Gauge	Mils	Design thickness (in)			
BDTK	20	33	0.0346	2-1/2	2-1/2	10
				3-5/8		
				4		
				6		
BDTK	18	43	0.0451	2-1/2	2-1/2	10
				3-5/8		
				4		
				6		

- Positive attachment that allows up to 1" of vertical movement
- Single-track assembly
- UL Classified R19236
- ICC-ES ESR1042



UL and UL Classified are registered trademarks of Underwriters Laboratories, Inc.

DEEP LEG DEFLECTION TRACK

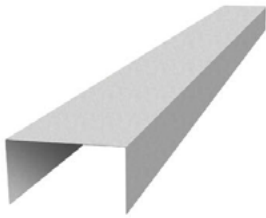

This traditional assembly allows for the deflection of floor beams or floor decks above interior partitions. The single, long leg track assembly requires 1-1/2" cold-rolled channel (CHN2) and 1-1/2" x 1-1/2" 16 gauge EasyClip™ Clip Angles (U-Series™), installed continuously throughout the upper-most punchouts (must be a maximum of 12" from the top track), to align the studs vertically within the plane of the wall.

Product code	Thickness			Web width (in)	Leg length (in)	Standard length (ft)
	Gauge	Mils	Design thickness (in)			
TSC	20	33	.0346	3-5/8	2	10
	20	33	.0346	6		
	18	43	.0451	3-5/8		
	18	43	.0451	6		
	16	54	.0566	3-5/8		
	16	54	.0566	6		
	14	68	.0713	3-5/8		
	14	68	.0713	6		
	12	97	.1017	3-5/8		
	12	97	.1017	6		
TSE	20	33	.0346	3-5/8	3	10
	20	33	.0346	6		
	18	43	.0451	3-5/8		
	18	43	.0451	6		
	16	54	.0566	3-5/8		
	16	54	.0566	6		
	14	68	.0713	3-5/8		
	14	68	.0713	6		
	12	97	.1017	3-5/8		
	12	97	.1017	6		

Custom sizes available upon request.

DoubleTrack™ (OVERTRACK) SYSTEM



ClarkDietrich DoubleTrack™ system is a two-piece top track assembly that allows for the deflection of floor beams or floor decks along interior partitions. A custom-made long leg outer track is installed to the underside of the floor deck. A wall assembly is constructed on the floor then slid into place. The wall assembly is designed to allow a "gap" at the top for deflection.

Product code	Thickness			Web width (in)	Leg length (in)	Standard length (ft)
	Gauge	Mils	Design thickness (in)			
OTSB	20	30	0.0312	3-3/4	1-1/4	10
				6-1/8		
OTSC	20	30	0.0312	3-3/4	2	10
				6-1/8		
OTSE	20	30	0.0312	3-3/4	3	10
				6-1/8		

Custom sizes available on request.

Fast Top™ CLIP



FTC3



FTC5

ClarkDietrich Fast Top™ clips are used in head-of-wall deflection conditions for in-fill curtain wall assemblies to provide for vertical movement. These clips are used in place of, or in combination with, deflection track. They also make a positive attachment and eliminate the need to install bridging continuously throughout the upper-most punchouts. Attach to the underside of structural members, concrete decks or floor assemblies. Studs must be cut less than full height to enable vertical movement up to 2-1/2" (1-1/4" up and down).

Product code	Thickness			Web width (in)	Leg length (in)	Standard length (ft)	Packaging Pcs./Carton
	Gauge	Mils	Design thickness (in)				
FTC3	14	68	0.0713	4	1-1/2	3-1/4	25
FTC5	14	68	0.0713	4	1-1/2	4-3/4	30

FTC3 includes 55 FastClip™ deflection screws per box.
 FTC5 includes 110 FastClip deflection screws per box.
 U.S. Patent No. 6,688,069

RedHeader RO™

Rough openings made easy.

Interior door and window framing is a whole lot easier with RedHeader RO™. RedHeader RO can cut your labor time in half. It's designed to replace conventional boxed or lay-in headers and built-up jambs and provide better results in half the time. One-piece headers and jambs eliminate the additional studs, tracks, and screws required to frame conventional rough openings. Headers and jambs are also pre-cut to specified lengths to eliminate field cutting. The adjustable Drop 'N Lock™ clip makes field adjustments a snap and provides a flat surface for a smooth drywall finish.



RedHeader RO HEADER

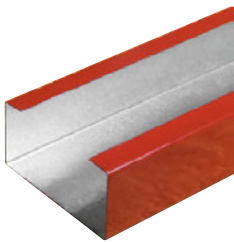

Headers are prepunched, and pre-cut to the length specified on your order. Header depth is 1/8" narrower than jamb depth to accommodate fit into Drop 'N Lock Clip. Header lengths should be ordered 1/2" shorter to fit inside our Drop 'N Lock clips.

Product code	Thickness			ksi	Depth (in)	Flange (in)	Return (in)
	Gauge	Mils	Design thickness (in)				
HEAD	20	33	0.0346	33	3-1/2	3	1
					3-7/8		
					5-7/8		
	18	43	0.0451	33	3-1/2	3	1
					3-7/8		
					5-7/8		
					7-7/8		

All material CP60.

RedHeader RO JAMB



As part of the RedHeader RO system, the jamb eliminates capped members, allowing drywall screws to drive through only one thickness of material. Plus, the open jamb does not require pre-insulating.

Product code	Thickness			ksi	Depth (in)	Flange (in)	Return (in)
	Gauge	Mils	Design thickness (in)				
JAMB	20	33	0.0346	33	3-5/8	3	7/8
					4		
					6		
	18	43	0.0451	33	3-5/8	3	7/8
					4		
					6		
					8		

All material CP60.

RedHeader RO Drop 'N Lock™ CLIP

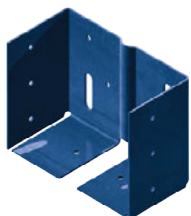

Prepunched slots allow for vertical field adjustments before fully attaching the clip, through the prepunched holes, to the RedHeader RO jamb stud. The "box-style" clip design makes it easy to drop the header into place and allows for one-man installation, even on large header spans. The clip is the same width as the jamb stud, reducing material buildup at this connection eliminating additional corner bead and taping costs.

Product code	Thickness			ksi	Depth (in)	Height (in)	Pcs./Box
	Gauge	Mils	Design thickness (in)				
DNLC333	20	33	0.0346	50	3-5/8	3	24
DNLC334					4	3	24
DNLC336					6	3	24
DNLC338					8	3	16

All material G90.

HEAVY-DUTY STUD (HDS®) FRAMING SYSTEM

Ultimate load capacity for headers and jambs.

The ClarkDietrich HDS® Framing System provides outstanding bending strength in two directions and superior axial strength. Plus, it reduces material, labor costs and installation time by up to 50%. The superior strength and carrying capacity of the HDS means higher performance with fewer members, like eliminating box beam headers, nesting track and stud for posts and jambs. It also means improved finish quality by eliminating excessive material and screw head buildup around doors and windows.

The HDSC header bracket is a unique, prepunched clip that turns a two-person curtain wall header installation into a one-person job.

- Use for curtain wall headers, jambs and sills; drywall headers and jambs; load-bearing jambs, and more.
- Openings up to 15' wide
- Eliminates multi-member built-up truss chords and webs
- Improves drywall finishing around doors and windows

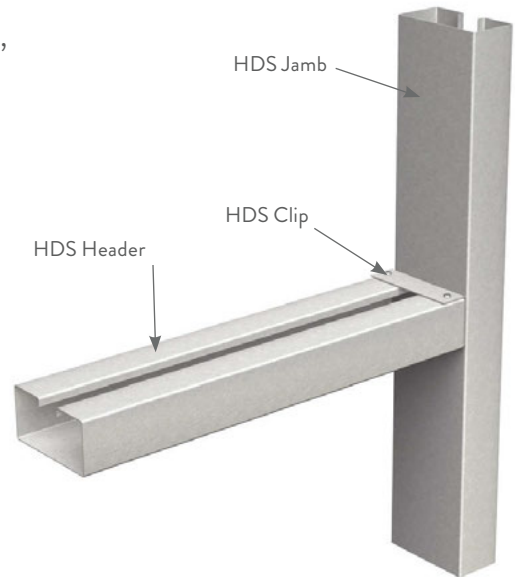

HDS HEADER/JAMB

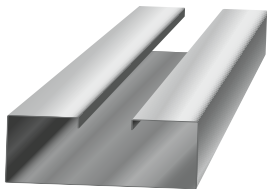

This highly innovative, multipurpose HDS Framing System provides cost-effective, member-reducing framing solutions for headers, jambs and posts.

Product code	Thickness			ksi	Depth (in)	Flange (in)	Return (in)
	Gauge	Mils	Design thickness (in)				
HDS3	20, 18	33, 43	0.0346,	33	3-5/8, 4	3	1-1/16
			0.0451		6, 8		2-1/4
HDS5	16, 14, 12	54, 68, 97	0.0566,	50	3-5/8, 4	3	1-1/16
			0.0713,		6, 8		2-1/4
			0.1017				

HDSC HEADER BRACKET



The HDSC header bracket is the perfect complement to the HDS Framing System. This simple, yet innovative header bracket turns a two-person curtain wall header installation into a one-person job. This unique, prepunched clip also eliminates surface head fastener buildup that can create finishing challenges.

Product code	Thickness			Size (in)
	Gauge	Mils	Design thickness (in)	
HDSC	14	68	0.0713	3-1/2 x 3-1/16 x 2
				3-7/8 x 3-1/16 x 2
				5-7/8 x 3-1/16 x 2
				7-7/8 x 3-1/16 x 2

Sold in pairs.

ProX Header® SYSTEM

Ideal for door, window, shaftwall, HVAC and ventilation openings. The Brady ProX Header® system provides a direct solution to the many problems associated with traditional headers. ProX Header is a superior and cost-effective alternative to the limited span capabilities of a single track, and the excessive buildup of traditional box headers. The ProX Header is designed for all interior and exterior door and window wall openings in the 3 to 12 ft. range.

- Standard single-piece design
- Installs flush leaving a smooth finish
- Installs quickly and consistently—and saves time and money

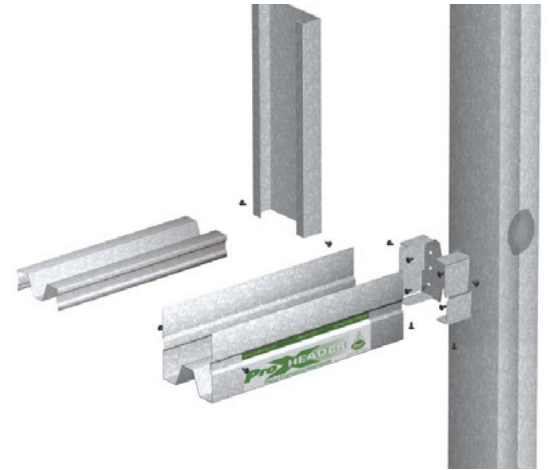

ProX Header



The ingenious ProX single-piece header is designed to replace multiple-piece built-up headers. The profile allows the product to snap into place on the jamb clip and hold itself while applying the mechanical fasteners.

Product code	Thickness			ksi	Width (in)	Height (in)
	Gauge	Mils	Design thickness (in)			
PXH	20	33	0.0346	33	3-5/8	4-1/4
	18	43	0.0451		4	
	16	54	0.0566		6	
	14	68	0.0713		8	

All material CP60. ProX Header® is a registered trademark of Brady Construction Innovations.

ProX INSERT



The ProX insert offers extra strength for longer spans. The strengthening insert positions itself over the single-piece header member and snaps into place to deliver greater load values.

Product code	Thickness			ksi	Width (in)	Height (in)
	Gauge	Mils	Design thickness (in)			
PXT	20	33	0.0346	33	3.464	1-5/8
	18	43	0.0451		3.839	
	16	54	0.0566		5.839	
	14	68	0.0713		7.839	

ProX CLIP



The ProX clip's offset tabs enable the ProX header to "snap" and hold itself in place during installation. After installation, all screw connections remain flush and ready for a smooth drywall finish.

Product code	Thickness			ksi	Depth (in)	Height (in)
	Gauge	Mils	Design thickness (in)			
PXTC	16	54	0.0566	50	1-1/2	3-5/8
						4
						6
						8

U.S. Patent Nos. 6,799,408 and 7,178,304 are owned by Brady Construction Innovations.

Spazzer® 9200 SPACER AND BRIDGING BAR



The TradeReady® Spazzer® 9200 bar is a pre-notched, 20 gauge, galvanized steel spacer and bridging bar. It facilitates rapid erection of studs into a rigid, accurately laid out gridwork that has excellent resistance to stud rotation and displacement. Hanging drywall is also faster and easier because the Spazzer 9200 bar eliminates the bow that often occurs in tall interior studs.

Product code	Thickness			Size (in)	Packaging	
	Gauge	Mils	Design thickness (in)		Pcs./Box	Pcs./Skid
SPZD	20	33	0.0346	7/8 x 7/8 x 50	N/A	1350

- Eliminates stud spacing layout at deck
- Improves drywall installation speed
- Automatically positions and rigidly holds studs on 16" or 24" centers without fasteners
- Eliminates clip angles and the labor required to install them

U.S. Patent Nos. 5,784,850 and 6,021,618

U-CHANNEL



Combined with the deep-leg track assembly and EasyClip™ clip angles (U-Series™) or SwiftClip™ (LS-Series), the U-channel creates a traditional assembly that allows for the deflection of floor beams or floor decks above interior partitions. The single, long leg track assembly requires 1-1/2" U-channel and 1-1/2" x 1-1/2" 16 gauge EasyClip or SwiftClip clip angles, installed continuously throughout the uppermost punchouts to align the studs vertically within the plane of the wall.

Product code	Member	Thickness			Size (in)
		Gauge	Mils	Design thickness (in)	
CHN1	075U50-54	16	54	0.0566	3/4
CHN2	150U50-54	16	54	0.0566	1-1/2

Available in 10', 16' and 20' lengths.

SwiftClip™ LS-Series™ SUPPORT CLIP



SwiftClip LS-Series™ support clips are used in multiple construction projects, specifically in conjunction with studs and track. The L-shaped clips fit between the stud flanges, so that shorter length clips do not need to be ordered. These labor time-savers include prepunched holes for quicker screw attachments, and are punched to accommodate for U-channel lateral bracing connections.

Product code	Thickness			Size (in)	Packaging Pcs./Bucket
	Gauge	Mils	Design thickness (in)		
LS543	16	54	0.0566	1-1/2 x 1-1/2 x 3-1/4	300
LS545				1-1/2 x 1-1/2 x 5-1/2	200
LS547				1-1/2 x 1-1/2 x 7-1/4	150
LS549				1-1/2 x 1-1/2 x 9-1/4	100
LS541				1-1/2 x 1-1/2 x 11-1/4	100
LS683	14	68	0.0713	1-1/2 x 1-1/2 x 3-1/4	300
LS685				1-1/2 x 1-1/2 x 5-1/2	200
LS687				1-1/2 x 1-1/2 x 7-1/4	100
LS689				1-1/2 x 1-1/2 x 9-1/4	100
LS681				1-1/2 x 1-1/2 x 11-1/4	50
LS973	12	97	0.1017	1-1/2 x 1-1/2 x 3-1/4	200
LS975				1-1/2 x 1-1/2 x 5-1/2	100
LS977				1-1/2 x 1-1/2 x 7-1/4	100
LS979				1-1/2 x 1-1/2 x 9-1/4	50
LS971				1-1/2 x 1-1/2 x 11-1/4	50

EasyClip™ U-Series™ CLIP ANGLE

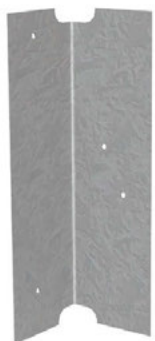

ClarkDietrich EasyClip U-Series clip angles are used to secure U-channel to wall studs for lateral bridging or for miscellaneous rigid connections. U-channel is passed through the stud knockout and an EasyClip U-Series clip is screw-attached or welded to provide a rigid connection. These clips are prepunched for faster, more accurate fastener placement. Do not use in bridging applications when the stud width exceeds 6."

Product code	Thickness			Size (in)	Packaging Pcs./Bucket
	Gauge	Mils	Design thickness (in)		
U543	16	54	0.0566	1-1/2 x 1-1/2 x 3-3/8	400
U545				1-1/2 x 1-1/2 x 5-3/4	200
U547				1-1/2 x 1-1/2 x 7-3/4	100
U549				1-1/2 x 1-1/2 x 9-3/4	100
U683	14	68	0.0713	1-1/2 x 1-1/2 x 3-3/8	200
U685				1-1/2 x 1-1/2 x 5-3/4	170
U687				1-1/2 x 1-1/2 x 7-3/4	100
U689				1-1/2 x 1-1/2 x 9-3/4	100
U973	12	97	0.1017	1-1/2 x 1-1/2 x 3-3/8	200
U975				1-1/2 x 1-1/2 x 5-3/4	130
U977				1-1/2 x 1-1/2 x 7-3/4	100
U979				1-1/2 x 1-1/2 x 9-3/4	80

EasyClip B-Series™ CLIP ANGLE



ClarkDietrich EasyClip B-Series™ clip angles are used to secure U-channel to wall studs in back-to-back framing applications and for various miscellaneous rigid connections. The shorter length of the B-Series clip enables it to be installed inside the C-shape. It can also be used to secure lateral bridging on single studs where the clip is preferred to be inside the C-shape. Do not use in lateral bridging when stud width exceeds 6."

Product code	Thickness			Size (in)	Packaging Pcs./Bucket
	Gauge	Mils	Design thickness (in)		
B543	16	54	0.0566	1-1/2 x 1-1/2 x 3	400
B545				1-1/2 x 1-1/2 x 5-1/4	200
B547				1-1/2 x 1-1/2 x 7-1/4	100
B549				1-1/2 x 1-1/2 x 9-1/4	100
B683	14	68	0.0713	1-1/2 x 1-1/2 x 3	200
B685				1-1/2 x 1-1/2 x 5-1/4	170
B687				1-1/2 x 1-1/2 x 7-1/4	100
B689				1-1/2 x 1-1/2 x 9-1/4	100
B973	12	97	0.1017	1-1/2 x 1-1/2 x 3	200
B975				1-1/2 x 1-1/2 x 5-1/4	130
B977				1-1/2 x 1-1/2 x 7-1/4	100
B979				1-1/2 x 1-1/2 x 9-1/4	80

EasyClip X-Series™ CLIP ANGLE



ClarkDietrich EasyClip X-Series™ clip angles are used to secure U-channel to wall studs for lateral bridging. U-Channel is passed through the stud knockout and an EasyClip X-Series clip is screw-attached or welded to provide a rigid connection. X-Series clip angles and U-channel should not be used in lateral bridging when stud width exceeds 6."

Product code	Thickness			Size (in)	Packaging Pcs./Bucket
	Gauge	Mils	Design thickness (in)		
X543	16	54	0.0566	2 x 2 x 3-3/8	200
X545				2 x 2 x 5-3/4	170
X547				2 x 2 x 7-3/4	100
X549				2 x 2 x 9-3/4	100
X683	14	68	0.0713	2 x 2 x 3-3/8	200
X685				2 x 2 x 5-3/4	100
X687				2 x 2 x 7-3/4	100
X689				2 x 2 x 9-3/4	80
X973	12	97	0.1017	2 x 2 x 3-3/8	100
X975				2 x 2 x 5-3/4	100
X977				2 x 2 x 7-3/4	60
X979				2 x 2 x 9-3/4	60

FLAT STRAPPING



Properly spaced horizontal steel bracing provides resistance to stud rotation and minor axis buckling under wind and axial loads. Block and strapping is typically used when wall studs exceed 6". Field cut, blocking is used if knockouts do not align. It's also used as bridging when framing members are unpunched.

Product code	Thickness			Size Available		Length (ft)
	Gauge	Mils	Design thickness (in)	Min. width (in)	Max. width (in)	
DTN3	20	33	0.0346	2	12	10
	18	43	0.0451			
DTN5	16	54	0.0566	2	12	10
	14	68	0.0713			
	12	97	0.1017			

DTN3 has a yield strength of 33,000psi.
DTN5 has a yield strength of 50,000psi.

Danback® WOOD BACKING PLATE



Just snap, flex and screw. It's that fast.

Danback® is a heavy-duty, flexible wood backing system used to support cabinets, shelves, handrails, wall-mounted sinks and counters, and all other wall-mounted fixtures. Danback provides superior connection shear and pullout strength to support and meet even some of the heaviest loading conditions. The patented hinge design actually flexes around the stud and snaps into place for a perfect fit—every time.

Product code	Width (in)	Length (in)	Packaging Pcs./Skid
D16F*	5-1/8	48	250
D24F*			
D16C**			
D24C**			

- Reduces installation time up to 90%
- Available for 16" and 24" o.c. framing
- Eliminates cutting, notching, ripping and routing
- Made with Dricon® fire-retardant treated wood
- Complies with all national building codes

Dricon® is a registered trademark of Arch Wood Protection, Inc.

Danback® is a registered trademark of Daniel W. Tollenaar.

U.S. Patent No. 6,705,056 of Daniel W. Tollenaar.

*F = fire-treated plywood. D16 = 16" o.c. spacing. D24 = 24" o.c. spacing.

Trimables available for off-module spacing in small bucket or bulk quantities.

**FSC-certified lumber available on request, which can contribute to LEED® points on your project. Contact ClarkDietrich LEED professionals at 888-437-3244 for more information. FSC chain-of-custody # BV-COC-008121.

FastBack™ BACKING CLIP



The FastBack™ backing system features a universal design that works with studs in either direction—concealing fasteners on the face of the product. The system creates an interlocked design between the stud and track for baseboard backing installations; and a cutaway design allows backing and bracing to be installed all the way to the floor.

Product code	Width (in)	Length (in)	Packaging Pcs./Carton
FBBC	1-1/4	5-1/8	100
FBBC	1-1/4	10-1/4	

U.S. Patent No. 7,882,676 is owned by Jeffery Thomas Ellis.



BACKING PLATE

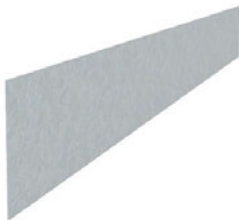

ClarkDietrich backing plate is a general multipurpose flat stock that is used for backer plate to support shelves, cabinets, fixtures or handrails when applied to metal framing. Backing plate should not be used as tension strapping or cross bracing. Diagonal Tension Strapping should be used in those applications.

Product code	Thickness			Size (in)	Length (ft)
	Gauge	Mils	Design thickness (in)		
BPN	25	18	0.0188	2	10
				3	
				4	
				6	
				8	
				10	
BPE	20	30	0.0312	2	10
				3	
				4	
				6	
				8	
				10	

Katz™ BLOCKING



Katz™ bridging maintains accurate member spacing to prevent bowing or flexing of nonload-bearing framing. It can also be used as backing between studs in areas where cabinets or fixtures are to be attached. Use standard 24" o.c. frame spacing.

Product code	Thickness			Size (in)	Length (ft)
	Gauge	Mils	Design thickness (in)		
KATZ	25	18	0.0188	3-5/8 x 1	24

16" available by special order.

NOTCHED TRACK



Notched track is used for bracing and bridging of joists and exterior walls. It's also ideal for use in hospitals and schools as mechanical backing to support equipment.

Product code	Thickness			Width (in)	Leg (in)
	Gauge	Mils	Design thickness (in)		
NOTC	18	43	0.0451	4	1, 1-1/4, 1-1/2
				6	
	16	54	0.0566	4	
				6	

Available West Coast only.

INTERIOR FRAMING

ClarkDietrich Shaftwall Systems

Tested, approved assemblies with unprecedented flexibility.

What makes the ClarkDietrich shaftwall construction system unique is that it has been tested with almost every gypsum board and shaftliner manufacturer in the country. Other systems are only tested with one type of gypsum board and shaftliner. Unlike competing systems, the ClarkDietrich CT-stud and J-tabbed track system provide maximum flexibility, allowing you to choose from a variety of board manufacturers. This unprecedented flexibility means quick availability of product at economical costs.

Shaftwall System consists of 1" shaftliner panels supported by 2-1/2", 4" or 6" CT-studs and faced on one side with varying layers of fire code board.

Stairwall Systems are designed to enclose stairwells, and are finished on both sides with varying layers of fire code board.

LIFE SAFETY & FIRE-RESISTANT PROTECTION

Shaftwall systems are nonload-bearing, fire-rated wall assemblies that provide critical, life safety, fire-resistant protection for elevator shafts, stairwells, vertical chases and mechanical enclosures. Shaftwalls in elevators and stairwells provide the only means of evacuation from the building in an emergency—making them one of the most

important wall assemblies in a building. Vertical chases and mechanical enclosures keep vital communication, power, water, fresh air and exhaust systems intact when a fire occurs.

CONSTRUCTION METHODS

Cavity shaftwalls are constructed utilizing one of two methods: masonry/CMU or light-gauge steel and gypsum. Gypsum drywall shaftwall construction has become the preferred and most widely used shaftwall assembly. These shaftwalls are lightweight, install faster, and provide lower in-place costs. They also significantly reduce structural framing and foundation costs, and are easy, quick and clean to install.

Masonry shaftwalls in high-rise buildings historically weigh between 20 and 45 lbs. per square foot, compared to gypsum assemblies that weigh between 10 and 13 lbs. per square foot. In addition to substantial weight reduction, gypsum shaftwall assemblies can be installed from the exterior of the shaft at each floor, eliminating the need for scaffolding.



Stairwall



Shaftwall

CT SHAFTWALL/STAIRWELL STUD



Engineered to maintain shaftwall integrity, ClarkDietrich CT cavity shaftwall studs are punched with 1" circular knockouts at 12" o.c. for easy installation of conduit or other mechanical service lines.

Independent laboratory tests have demonstrated that the slotting in the web improves resistance to thermal and noise transmissions effectively.

Product code	Thickness			Stud depth (in)
	Gauge	Mils	Design thickness (in)	
CTN2	25	21	0.0230	2-1/2
CTE2	20	33	0.0346	2-1/2
CTN4	25	21	0.0230	4
CTE4	20	33	0.0346	4
CTE6	20	33	0.0346	6

For installations requiring compliance with NER506, special order products are required.

J-TABBED TRACK/J-RUNNER



ClarkDietrich J-tabbed track is used at the floor and ceiling in shaftwall assemblies. CT-studs and gypsum shaftliner panels are friction fit between the top and bottom J-tabbed track. J-tabbed tracks have unequal legs with the longer leg (available in 2-1/4" and 3") installed against the shaft. The leg provides a backstop for easy installation of the shaftliner. Three-inch leg track is typically used as jamb struts around closure details, including duct and door openings, abutments and intersections.

ClarkDietrich J-tabbed track is punched with fold-up tabs every 12," permitting faster, more efficient installation.

Product code	Gauge	Thickness		Size	
		Mils	Design thickness (in)	Width (in)	Leg (in)
TTN (2,3)*	25	21	0.0230	2-1/2	2-1/4 3
				4	2-1/4 3
TTE (2,3)*	20	33	0.0346	2-1/2	2-1/4 3
				4	2-1/4 3
				6	2-1/4 3

*2 designates 2-1/4" leg; 3 designates 3" leg.

Note: Revised ICC Report pending.

USG Shaftwall Systems

USG SHEETROCK® brand shaftwall systems.

These systems are nonload-bearing gypsum panel partitions designed to construct elevator shafts, mechanical shafts, stairwells, air returns and horizontal membranes. SHEETROCK brand shaftwall systems have been comprehensively tested for 1- to 4-hour fire resistance ratings (UL Design No. U415) only when all of the system

components are used together. Substitutions of any of the components are not recommended.

Metal framing members for the system consist of USG CH-studs, USG J-runners, USG E-studs and USG jamb struts. Each steel component is formed to produce a strong, highly efficient member.

Available Eastern U.S. only.

USG SHEETROCK® is a registered trademark of USG Corporation.

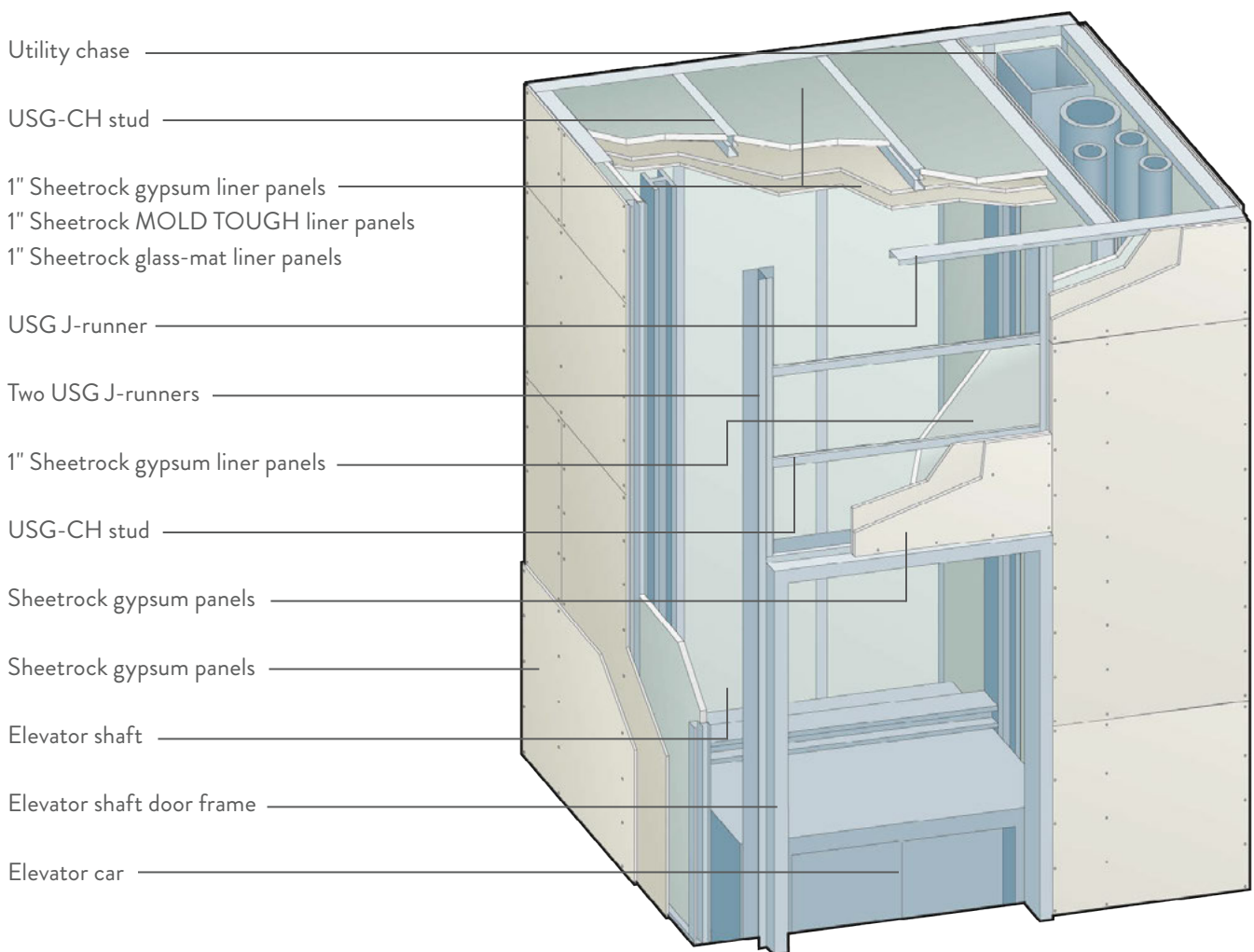

USG CH-STUD

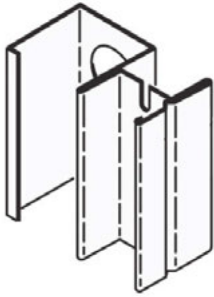

USG CH-studs are nonload-bearing members installed between abutting liner panels. They have 1" holes for easy installation of horizontal pipe and conduit.

Product code	Thickness			Depth (in)
	Gauge	Mils	Design thickness (in)	
USG CHN2	25	18	0.0188	2-1/2
USG CHN4				4
USG CHE2	20	34	0.0359	2-1/2
USG CHE4				4
USG CHE6				6

USG E-STUD

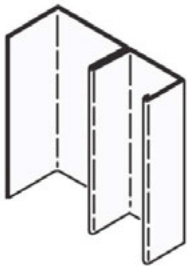

USG E-studs are 2-1/2," 4" or 6" wide, used simply to cap panels at intersections with exterior walls or back-to-back on studs in unusually high partitions.

Product code	Thickness			Depth (in)
	Gauge	Mils	Design thickness (in)	
USG ESN2	25	18	0.0188	2-1/2
USG ESN4				4
USG ESE2	20	34	0.0359	2-1/2
USG ESE4				4
USG ESE6				6

USG J-RUNNER

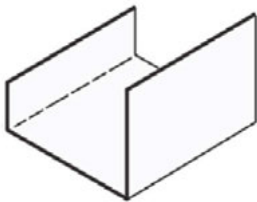

USG J-runner is used at the floor and ceiling in shaftwall systems. CH-studs and shaftliner panels are friction-fitted between the top and bottom J-track.

Product code	Thickness			Size	
	Gauge	Mils	Design thickness (in)	Width (in)	Leg (in)
USG JRN2	24	23	0.0239	2-1/2	2
USG JRN4				4	
USG JRE2	20	34	0.0359	2-1/2	2
USG JRE4				4	
USG JRE6				6	

USG JAMB STRUT

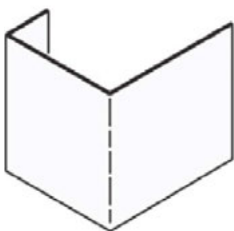

USG jamb struts are used in jamb framing for fire-rated elevator doors.

Product code	Thickness			Size	
	Gauge	Mils	Design thickness (in)	Width (in)	Leg (in)
USG JSN2	24	23	0.0239	2-1/2	3
USG JSN4				4	
USG JSE2	20	34	0.0359	2-1/2	3
USG JSE4				4	
USG JSE6				6	

ClarkDietrich Area Separation Wall Systems

Fire-resistance protects lives and property.

Area separation walls are nonload-bearing, 2-hour rated vertical wall assemblies that provide fire-resistant protection between adjacent living units in apartment buildings, condominiums and townhouses. They are also referred to as party walls, firewalls, multi-family walls and H-stud assemblies.

Assembled between two independent walls, area separation walls form a commonly shared party wall that extends from the foundation through the roofline. The walls are assembled with two 1"-thick gypsum panel liners vertically

installed between 2" H-studs spaced 24" o.c. At the top and bottom of the walls, C-runners (or H-tracks) are installed back-to-back between vertically stacked panels. Overall stacked area separation wall assemblies cannot exceed 50 feet.

A photo of an area separation wall system after a fire is shown below. Although this was a tragic event, it clearly proves the effectiveness of the system. It performed as designed by maintaining the integrity of the firewall, protecting the lives and property of the adjacent units.



H-STUD



ClarkDietrich H-studs are 2" wide vertical members used to secure two 1" thick pieces of gypsum shaftliner in area separation wall assemblies. H-studs are inserted into C-runners and slid over gypsum panel liner edges, repeating until the desired wall length is achieved. Once the wall is plumbed, it is secured with aluminum burn clips.

Product code	Thickness			Size	
	Gauge	Mils	Design thickness (in)	Width (in)	Length (ft)
HSN	25	18	0.0188	2-1/16	8
					10
					12

Two-hour fire-rated assembly and ICC approved.

C-RUNNER



ClarkDietrich C-runner (or H-track) is used to secure H-stud and gypsum shaftliner panels in area separation wall assemblies. Attached to the foundation with powder-actuated fasteners, C-runner is also used as top track to cap the H-stud and gypsum shaftliner panels, with a second track screwed back-to-back to the lower runner, to hold the next assembly level.

Product code	Thickness			Size	
	Gauge	Mils	Design thickness (in)	Width (in)	Length (ft)
HRN1	25	18	0.0188	2-1/8	8
					10

Two-hour fire rated assembly and ICC approved.

ALUMINUM BURN CLIP



ClarkDietrich aluminum burn clips are used as part of the H-stud area separation wall assembly and are designed to melt when exposed to fire. The clips hold the area separation wall assemblies in place at the floor, roof and truss line between adjacent units. In a fire, the aluminum burn clips on the fire-ridden side of the wall will melt, allowing the wall structure for that side to collapse.

Product code	Thickness (in)	Size (in)	Packaging Pcs./Bucket
AB	0.050	2 x 2 x 2-1/2	500
AB63*	0.063	2 x 2 x 2-1/2	

*AB63 meets requirements of ICC-ES Legacy Report 92-19.

EXTERIOR FRAMING

From low-rise to high-rise, count on exterior framing that stands tall.

The high strength-to-weight ratio of light-gauge steel framing maximizes design flexibility and delivers superior structural integrity for a variety of criteria, including high wind and seismic loads. It's also easily insulated for energy conservation and provides noncombustible support for fire-rated construction.

Light-gauge steel is an ideal exterior framing material for all types of low- to high-rise commercial structures, including educational, institutional, multi-family and multi-use. Because of its strength, ease of installation

and cost-effectiveness, steel is also an excellent choice for residential construction. While light-gauge steel is commonly stick-framed, it is also highly suited for prefabricated panel construction, providing additional economy in today's highly competitive construction industry.

- Used as primary framing up to nine stories
- Economically combined with structural steel or concrete
- Ideal support for brick-veneer, stucco and E.I.F.S.
- Curtain wall, axial load-bearing wall and head-of-wall deflection systems
- Door and window framing
- Bridging and bracing systems
- Conventional or specialty load-bearing headers

NOTE: This catalog does not provide load data (load capacities, limiting heights, physical and structural properties and span data) necessary for building design. Contact ClarkDietrich at 888-437-3244 for technical assistance.



C-STUDS



C-Studs (C-Series™)

Light-gauge C-shaped framing members for axial load-bearing walls, curtain walls, tall interior partitions, floor joists and roof truss assemblies.

Two of the key differences between the various C-stud/Joist framing members are the flange and return dimensions. The flange is typically the bearing surface for cladding materials and a key contributor to the load-bearing capacity of the member.

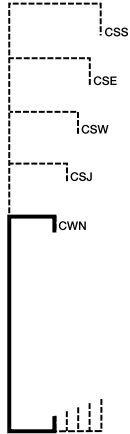

ClarkDietrich CWN™ 1-3/8" Flange

Curtain wall studs have a 1-3/8" flange and 3/8" return and are used to support the exterior skin or cladding material (metal, stone, tile, glass, etc.) and the wind loads they are subjected to.

Product code*	Member	Thickness gauge (mils)	Depth (in)	Flange (in)	Return (in)
CWN3 (20 & 18 gauge) CWN5 (16 & 14 gauge)	250S137-x	20 (33), 18 (43), 16 (54), 14 (68)	2-1/2	1-3/8	3/8
	362S137-x		3-5/8		
	400S137-x		4		
	600S137-x		6		
	800S137-x		8		

ClarkDietrich CSJ™ 1-5/8" Flange

Studs/joist have a 1-5/8" flange and a 1/2" return and are considered the industry standard. CSJ members are the most widely used and specified framing members. They provide the vertical strength necessary for demanding load-bearing structural applications and sufficient strength for many joist applications.

Product code*	Member	Thickness gauge (mils)	Depth (in)	Flange (in)	Return (in)
CSJ3 (20 & 18 gauge) CSJ5 (16, 14 & 12 gauge)	250S162-x	20 (33), 18 (43), 16 (54), 14 (68), 12 (97)	2-1/2	1-5/8	1/2
	350S162-x		3-1/2		
	362S162-x		3-5/8		
	400S162-x		4		
	550S162-x		5-1/2		
	600S162-x		6		
	800S162-x		8		
	1000S162-x		10		
	1200S162-x		12		
	1400S162-x		14		

ClarkDietrich CSW™ 2" Flange

Wide studs/joist have a 2" wide flange and a 5/8" return that provides a larger bearing surface for attaching sub-flooring or sheathing materials. This framing member is also used in axial load-bearing wall assemblies.

Product code*	Member	Thickness gauge (mils)	Depth (in)	Flange (in)	Return (in)
CSW3 (20 & 18 gauge) CSW5 (16, 14 & 12 gauge)	362S200-x	20 (33), 18 (43), 16 (54), 14 (68), 12 (97)	3-5/8	2	5/8
	400S200-x		4		
	600S200-x		6		
	800S200-x		8		
	1000S200-x		10		
	1200S200-x		12		
	1400S200-x		14		

ClarkDietrich CSE™ 2-1/2" Flange

Extra-wide studs/joist have a 2-1/2" wide flange and a 5/8" return and are used in floor joist assemblies and heavy loading conditions.

Product code*	Member	Thickness gauge (mils)	Depth (in)	Flange (in)	Return (in)
CSE3 (20 & 18 gauge) CSE5 (16, 14 & 12 gauge)	362S250-x	20 (33), 18 (43), 16 (54), 14 (68), 12 (97)	3-5/8	2-1/2	5/8
	400S250-x		4		
	600S250-x		6		
	800S250-x		8		
	1000S250-x		10		
	1200S250-x		12		
	1400S250-x		14		

ClarkDietrich CSS™ 3" Flange

Super-wide studs/joist have a 3" flange and a 5/8" return and are used in very heavy loading and long spanning conditions.

Product code*	Member	Thickness gauge (mils)	Depth (in)	Flange (in)	Return (in)
CSS3 (18 gauge) CSS5 (16, 14 & 12 gauge)	600S300-x	18 (43), 16 (54), 14 (68), 12 (97)	6	3	5/8
	800S300-x		8		
	1000S300-x		10		
	1200S300-x		12		
	1400S300-x		14		

*20 and 18 gauge are standard as 33ksi yield strength. 16, 14 and 12 gauge are standard as 50ksi yield strength.
x = mil thickness identifier

KNOCKOUTS/KNOCKOUT PATTERN

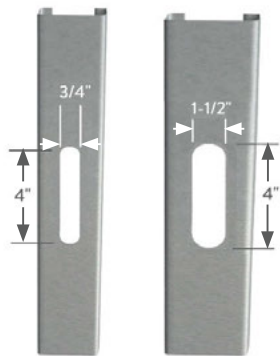

2-1/2" wide studs

3-1/2" and wider studs

ClarkDietrich light-gauge C-studs for axial load-bearing and curtain wall framing are prepunched with knockouts at regular intervals. These punchouts are specifically designed to allow for rapid installation of pipes, electrical conduit and wall bridging.

Standard knockout sizing is 1-1/2" x 4" in members 3-1/2" and wider. Members smaller than 3-1/2" are unpunched unless otherwise specified at time of order. If specified, members will be punched with a 3/4" x 4" knockout.

Knockouts are punched 12" o.c. from the lead edge with additional knockouts every 24" o.c. (on the West Coast, the first knockout is punched 24" o.c. from the lead edge). Caution must be exercised when installing studs so knockouts align for bridging. Based on stud length, the distance the knockout falls from the tail end of the stud may not be the same from the lead end. To align punchouts, make sure to use the same end in the same direction consistently.

GROMMETS



2-Piece Grommet



Snap-In Bushing

Grommets snap easily into stud knockouts and are used to protect electrical wiring and plumbing lines from contacting metal. Grommets are commonly used when metal conduit is not required by building code.

Product code	Size (in)	Description	Pcs./Carton
GROM	3/4	For 1-5/8" and 2-1/2" studs	100
	1-1/2	For 3-1/2" and wider studs	

STRUCTURAL TRACK



ClarkDietrich structural track is a U-shaped framing component used as top and bottom runners to secure wall studs. Structural track is also used as end support closures for joists at exterior or foundation walls, head and sill plates of wall openings and solid blocking. Track is normally ordered in corresponding size and gauge to the wall studs.

Product code	Member	Thickness			Leg length (in)
		Gauge	Mils	Design thickness (in)	
TSA	x-T100-y	20, 18, 16, 14, 12	33, 43, 54, 68, 97	2-1/2, 3-1/2, 3-5/8, 4, 5-1/2, 6, 8, 10, 12, 14	1
TSB	x-T125-y				1-1/4
TSF	x-T150-y				1-1/2
TSC	x-T200-y				2
TSD	x-T250-y				2-1/2
TSE	x-T300-y				3

x = Part depth. Tracks are available to match all stud and joist depths.
y = Mil thickness of steel.

CORNER ANGLE



ClarkDietrich heavy-gauge corner or utility angle is commonly used for a variety of applications including: concrete pour stop, connection strut or angle, roof ridge angles and corner reinforcement.

Product code	Thickness			Size* (in)	Length* (ft)
	Gauge	Mils	Design thickness (in)		
CAE	20	33	0.0346	2 x 2	10
CAM	18	43	0.0451		
	16	54	0.0566		
	14	68	0.0713		
	12	97	0.1017		
CAE	20	33	0.0346	3 x 3	10
CAM	18	43	0.0451		
	16	54	0.0566		
	14	68	0.0713		
	12	97	0.1017		

*Other sizes available on request.

HEAVY-DUTY FURRING CHANNEL



ClarkDietrich heavy-duty furring channel is a high-performance framing component used in ceiling, exterior wall and roof applications. With two standard depths—7/8" and 1-1/2"—heavy-duty furring channel provides greater resistance to deflection and bending. In roof applications, heavy-duty furring is used as purlins to provide connection points for roof sheathing.

Product code	Member	Thickness			Size (in)	Length (ft)
		Gauge	Mils	Design thickness (in)		
FCM	087F125-43	18	43	0.0451	7/8	10, 12
	087F125-54	16	54	0.0566		
FCMD	150F125-43	18	43	0.0451	1-1/2	10, 12
	150F125-54	16	54	0.0566		

CUSTOM SHAPES AND MISCELLANEOUS ANGLES



ClarkDietrich custom fabricates just about any shape, bend, angle or specialty framing component to your exact specification. Custom parts include corner angles, roof ridge angles, clip angles, long and uneven leg tracks, eave closures, support clips and furring channels. To ensure proper fabrication, ClarkDietrich requires a detailed, fully dimensioned part drawing at time of order placement.

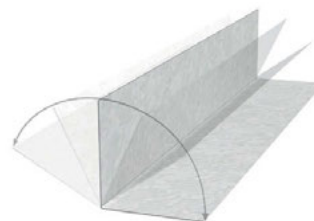

RedHeader RO™

Rough openings made easy.

RedHeader RO™ can cut your labor time in half. It's designed to replace conventional boxed or lay-in headers and built-up jambs and provide better results in half the time. One-piece headers and jambs eliminate the additional studs, tracks, and screws required to frame conventional rough openings. Headers and jambs are also pre-cut to specified lengths to eliminate field cutting. The adjustable Drop 'N Lock™ clip makes field adjustments a snap and provides a flat surface for a smooth drywall finish. Save on framing time, save on drywall finishing time, and use about half the materials that conventional rough opening framing methods require.



RedHeader RO HEADER

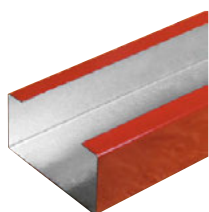

Unpunched headers are pre-cut to the length specified on your order. Header depth is 1/8" narrower than jamb depth to accommodate fit into Drop 'N Lock clip. Header lengths should be ordered 1/2" shorter to fit inside our Drop 'N Lock clips. RedHeader RO Extra-Duty headers have a longer 3-1/2" flange for wider spans.

One RedHeader RO

(1) RedHeader with:
(1) track for cripple attachments
w/ (2) screws at 16" o.c.

Replaces

Typical lay-in header with:
(1) 1-5/8" flange stud & (2) tracks
w/ (4) screws at 16" o.c.

Typical boxed header with:
(2) 1-5/8" flange studs & (2) tracks
w/ (4) screws at 16" o.c.

Standard headers

Product code	Thickness			ksi	Depth* (in)	Flange (in)	Return (in)
	Gauge	Mils	Design thickness (in)				
HEAD	18	43	0.0451	33	3-1/2	3	1
					3-7/8		
					5-7/8		
					7-7/8		
	16	54	0.0566	50	3-1/2	3	1
					3-7/8		
					5-7/8		
					7-7/8		
	14	68	0.0713	50	3-1/2	3	1
					3-7/8		
					5-7/8		
					7-7/8		
12	97	0.1017	50	3-1/2	3	1	
				3-7/8			
				5-7/8			
				7-7/8			

All material CP60.

*Header width is 1/8" less than jamb depth to fit inside Drop 'N Lock clip.

Extra-Duty headers

Product code	Thickness			ksi	Depth* (in)	Flange (in)	Return (in)
	Gauge	Mils	Design thickness (in)				
HEAD	16	54	0.0566	50	3-1/2	3-1/2	1
					3-7/8		
					5-7/8		
					7-7/8		
	14	68	0.0713	50	3-1/2	3-1/2	1
					3-7/8		
					5-7/8		
					7-7/8		
	12	97	0.1017	50	3-1/2	3-1/2	1
					3-7/8		
					5-7/8		
					7-7/8		

All material CP60.

*Header width is 1/8" less than jamb depth to fit inside Drop 'N Lock clip.

RedHeader RO JAMB

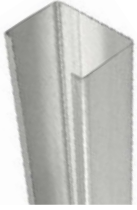

As part of the RedHeader RO system, the jamb eliminates capped members, allowing drywall screws to drive through only one thickness of material. Plus, the open jamb does not require pre-insulating. RedHeader RO Extra-Duty jambs have a longer 3-1/2" flange for wider spans.

One RedHeader RO jamb stud

(1) RedHeader RO jamb stud:
No track or screws required to build up sections

Replaces

Typical jamb with:
(2) 1-5/8" flange studs & (1) track
w/ (4) screws at 16" o.c.

Standard jambs

Product code	Thickness			ksi	Depth (in)	Flange (in)	Return (in)
	Gauge	Mils	Design thickness (in)				
JAMB	18	43	0.0451	33	3-5/8	3	7/8
					4		
					6		
					8		
	16	54	0.0566	50	3-5/8	3	7/8
					4		
					6		
					8		
	14	68	0.0713	50	3-5/8	3	7/8
					4		
					6		
					8		
12	97	0.1017	50	3-5/8	3	7/8	
				4			
				6			
				8			

All material CP60.

Extra-Duty jambs

Product code	Thickness			ksi	Depth (in)	Flange (in)	Return (in)
	Gauge	Mils	Design thickness (in)				
JAMB	16	54	0.0566	50	3-5/8	3-1/2	7/8
					4		
					6		
					8		
	14	68	0.0713	50	3-5/8	3-1/2	7/8
					4		
					6		
					8		
	12	97	0.1017	50	3-5/8	3-1/2	7/8
					4		
					6		
					8		

All material CP60.

RedHeader RO Drop 'N Lock™ CLIP

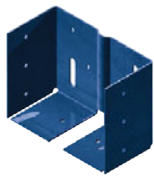

Prepunched slots allow for vertical field adjustments before fully attaching the clip to the RedHeader RO jamb stud. The narrower header and clip width reduce material buildup that pushes the gypsum board out, eliminating additional corner bead and taping costs.

Product code	Thickness			ksi	Depth (in)	Height (in)	Pcs./Box
	Gauge	Mils	Design thickness (in)				
DNLC683	14	68	0.0713	50	3-5/8	3	24
DNLC684					4		
DNLC686					6		
DNLC688					8		

All material G90.

HEAVY-DUTY STUD (HDS®) FRAMING SYSTEM

Ultimate load capacity for headers and jambs.

The ClarkDietrich Heavy-Duty Stud (HDS®) Framing System provides outstanding bending strength in two directions and superior axial strength. Plus, it reduces material, labor costs and installation time by up to 50%.

The superior strength and carrying capacity of the HDS means higher performance with fewer members, like eliminating box beam headers, nesting track and stud for posts and

jambs. It also means improved finish quality by eliminating excessive material and screw head buildup around doors and windows.

- Use for curtain wall headers, jambs and sills; drywall headers and jambs; load-bearing jambs, and more.
- Openings up to 15' wide
- Eliminates multi-member built-up truss chords and webs
- Improves drywall finishing around doors and windows

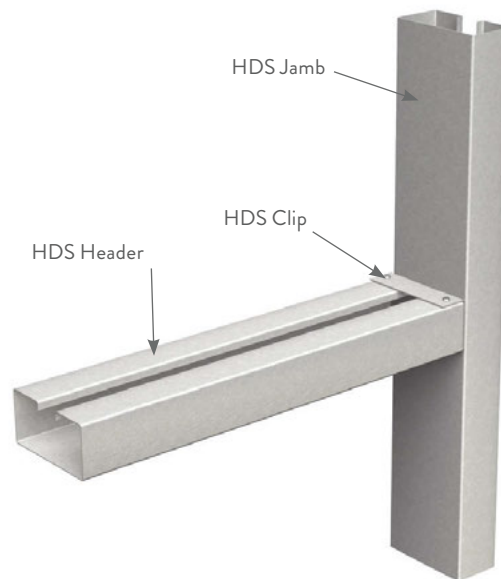

HDS HEADER/JAMB

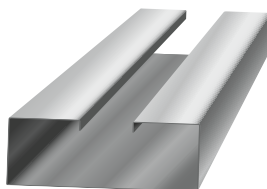

This highly innovative, multipurpose HDS Framing System provides cost-effective, member-reducing framing solutions for headers, jambs and posts.

Product code	Thickness			ksi	Depth (in)	Flange (in)	Return (in)
	Gauge	Mils	Design thickness (in)				
HDS3	20, 18	33, 43	0.0346, 0.0451	33	3-5/8, 4	3	1-1/16
					6, 8	3	2-1/4
HDS5	16, 14, 12	54, 68, 97	0.0566, 0.0713, 0.1017	50	3-5/8, 4	3	1-1/16
					6, 8	3	2-1/4

HDSC HEADER BRACKET



The HDSC header bracket is the perfect complement to the HDS Framing System. This simple, yet innovative header bracket turns a two-person curtain wall header installation into a one-person job. This unique, prepunched clip also eliminates surface head fastener buildup that can create finishing challenges.

Product code	Thickness			Size (in)
	Gauge	Mils	Design thickness (in)	
HDSC	14	68	0.0713	3-1/2 x 3-1/16 x 2
				3-7/8 x 3-1/16 x 2
				5-7/8 x 3-1/16 x 2
				7-7/8 x 3-1/16 x 2

Sold in pairs.

ProX Header® SYSTEM

Ideal for door, window, shaftwall, HVAC and ventilation openings.

The Brady ProX Header® system provides a direct solution to the many problems associated with traditional headers. ProX Header is a superior and cost-effective alternative to the limited span capabilities of a single track, and the excessive buildup of traditional box headers. The ProX Header is designed for all interior and exterior door and window wall openings in the 3 to 12 ft. range.

- Standard single-piece design
- Installs flush leaving a smooth finish
- Installs quickly and consistently—and saves time and money



ProX Header



The ingenious ProX single-piece header is designed to replace multiple-piece built-up headers. The profile allows the product to snap into place on the jamb clip and hold itself while applying the mechanical fasteners.

Product code	Thickness			ksi	Width (in)	Height (in)
	Gauge	Mils	Design thickness (in)			
PXH	20	33	0.0346	33	3-5/8	4-1/4
	18	43	0.0451		4	
	16	54	0.0566		6	
	14	68	0.0713		8	

All material CP60.

ProX Header® is a registered trademark of Brady Construction Innovations.

ProX INSERT



The ProX insert offers extra strength for longer spans. The strengthening insert positions itself over the single-piece header member and snaps into place to deliver greater load values.

Product code	Thickness			ksi	Width (in)	Height (in)
	Gauge	Mils	Design thickness (in)			
PXT	20	33	0.0346	33	3.464	1-5/8
	18	43	0.0451		3.839	
	16	54	0.0566		5.839	
	14	68	0.0713		7.839	

ProX CLIP



The ProX clip's offset tabs enable the ProX header to "snap" and hold itself in place during installation. After installation, all screw connections remain flush and ready for a smooth drywall finish.

Product code	Thickness			ksi	Depth (in)	Height (in)
	Gauge	Mils	Design thickness (in)			
PXTC	16	54	0.0566	50	1-1/2	3-5/8
						4
						6
						8

U.S. Patent Nos. 6,799,408 and 7,178,304 are owned by Brady Construction Innovations.

MaxTrak® SLOTTED DEFLECTION TRACK



MaxTrak® is a head-of-wall deflection track that is used for framing exterior curtain walls and nonload-bearing interior walls where vertical deflection occurs—and serves as a connecting member that isolates the cold-formed steel framing system from the movement of the primary structure.

Product code	Thickness		Web width (in)	Leg length (in)	Standard length (ft)
	Gauge	Mils			
75025	18	43	2-1/2	2-1/2	10
75026	16	54			
75027	14	68	3-5/8	2-1/2	10
75035	18	43			
75036	16	54	4	2-1/2	10
75037	14	68			
75045	18	43	6	2-1/2	10
75046	16	54			
75047	14	68	8	2-1/2	10
75065	18	43			
75066	16	54	8	2-1/2	10
75067	14	68			
75085	18	43	8	2-1/2	10
75086	16	54			
75087	14	68			

- Positive attachment with total allowable vertical movement of 1-1/2" (±3/4")
- One-piece system reduces cost of materials and labor
- UL Classified R26034
- IAPMO #0145



MaxTrak 2D SLOTTED DEFLECTION & DRIFT TRACK



MaxTrak 2D is a head-of-wall deflection track that is used for framing exterior curtain walls and nonload-bearing interior walls where vertical deflection and horizontal drift occurs—and serves as a connecting member that isolates the cold-formed steel framing system from the movement of the primary structure.

Product code	Thickness		Web width (in)	Leg length (in)	Standard length (ft)
	Gauge	Mils			
75125	18	43	2-1/2	2-1/2	10
75126	16	54			
75127	14	68	3-5/8	2-1/2	10
75135	18	43			
75136	16	54	4	2-1/2	10
75137	14	68			
75145	18	43	6	2-1/2	10
75146	16	54			
75147	14	68	8	2-1/2	10
75165	18	43			
75166	16	54	8	2-1/2	10
75167	14	68			
75185	18	43	8	2-1/2	10
75186	16	54			
75187	14	68			

- Total allowable vertical movement of 1-1/2" (±3/4")
- Total allowable horizontal movement (drift) of 4" (±2")
- Slots in web (for seismic design) are 4" long, spaced at 8" o.c.



SLP-TRK® SLOTTED TRACK



SLP-TRK® slotted track is the most cost-effective, positively attached fire-rated deflection system. It provides a positive attachment for overall strength and allows for vertical movement caused by normal head-of-wall and floor extension or compression. It also smoothly integrates with a variety of wall installation systems and is extremely user-friendly as well as economical. The simple design and easy installation reduces the cost of materials and labor. And the installer can use the head-of-wall systems he prefers to work with.

Product code	Thickness			Web width (in)	Leg length (in)	Standard length (ft)
	Gauge	Mils	Design thickness (in)			
BDTK	18	43	0.0451	2-1/2	2-1/2	10
				3-5/8		
				4		
				6		
				8		
BDTK	16	54	0.0566	2-1/2	2-1/2	10
				3-5/8		
				4		
				6		
				8		
BDTK	14	68	0.0713	2-1/2	2-1/2	10
				3-5/8		
				4		
				6		
				8		

- Positive attachment that allows up to 1" of vertical movement
- Single-track assembly
- Approved 1- and 2-hour systems
- Meets IBC, BOCA, SBCCI, ASTM, UL2079, and UBC building codes and standards



Custom sizes available on request.
SLP-TRK® is a registered trademark of Brady Construction Innovations.

SLP-TRK FOR SEISMIC



SLP-TRK for Seismic is a head-of-wall deflection track that is used for framing exterior curtain walls and nonload-bearing interior walls where vertical deflection and horizontal drift occurs—and serves as a connecting member that isolates the cold-formed steel framing system from the movement of the primary structure.

Product code	Thickness		Web width (in)	Leg length (in)	Standard length (ft)		
	Gauge	Mils					
BDTK-WS	18	43	2-1/2	2-1/2	10		
	16	54					
	14	68					
	BDTK-WS	18	43	3-5/8	2-1/2	10	
		16	54				
		14	68				
		BDTK-WS	18	43	4	2-1/2	10
			16	54			
			14	68	6	2-1/2	10
	18		43				
	BDTK-WS	16	54	8	2-1/2	10	
		14	68				
		18	43	4	2-1/2	10	
		16	54				

- Total allowable vertical movement of 1-1/2" (±3/4")
- Total allowable horizontal movement (drift) of 4" (±2")
- Slots in web (for seismic design) are 2-1/4" long, spaced at 4" o.c.



SLP-TRK® is a registered trademark of Brady Construction Innovations.

EXTERIOR FRAMING

DEEP LEG DEFLECTION TRACK



This traditional assembly accommodates the deflection of floor beams or floor decks at the head-of-wall. The single long leg track assembly requires 1-1/2" cold-rolled channel and 1-1/2" x 1-1/2" 16 gauge EasyClip™ clip angles (U-Series™) installed continuously throughout the upper-most punchouts to align the studs vertically within the plane of the wall. Deflection track details must be designed for the specific conditions of a building to accommodate the required deflection and end reactions of the studs. Deflection tracks cannot be used in axial load-bearing stud conditions or above continuous window spandrels.

Product code	Member	Thickness		Size (in)
		Gauge	Design thickness (in)	
TSC	362T200-33	20	0.0346	3-5/8
	600T200-33			6
	362T200-43	18	0.0451	3-5/8
	600T200-43			6
	362T200-54	16	0.0566	3-5/8
	600T200-54			6
	362T200-68	14	0.0713	3-5/8
	600T200-68			6
362T200-97	12	0.1017	3-5/8	
600T200-97			6	
TSE	362T300-33	20	0.0346	3-5/8
	600T300-33			6
	362T300-43	18	0.0451	3-5/8
	600T300-43			6
	362T300-54	16	0.0566	3-5/8
	600T300-54			6
	362T300-68	14	0.0713	3-5/8
	600T300-68			6
362T300-97	12	0.1017	3-5/8	
600T300-97			6	

Custom sizes available on request.

DoubleTrack™ (OVERTRACK) SYSTEM



ClarkDietrich DoubleTrack™ system is a two-piece assembly that accommodates deflection of exterior curtain walls. A custom-made deep leg outer track is installed to the underside of the floor deck. A wall assembly is constructed on the floor and slid into place, with a "gap" at the top for deflection. DoubleTrack deflection assemblies cannot be used in axial load-bearing stud conditions or above continuous window spandrels.

Product code*	Thickness			Web width (in)	Leg length (in)	Standard length (ft)
	Gauge	Mils	Design thickness (in)			
OTSC	20	33	0.0346	3-3/4	2	10
				6-1/8		
	18	43	0.0451	3-3/4		
				6-1/8		
	16	54	0.0566	3-7/8		
				6-1/4		
14	68	0.0713	3-7/8			
			6-1/4			
12	97	0.1017	3-7/8			
			6-1/4			
OTSE	20	33	0.0346	3-3/4	3	10
				6-1/8		
	18	43	0.0451	3-3/4		
				6-1/8		
	16	54	0.0566	3-7/8		
				6-1/4		
14	68	0.0713	3-7/8			
			6-1/4			
12	97	0.1017	3-7/8			
			6-1/4			

*C = 2" legs; E = 3" legs.

Custom sizes available on request.

Fast Top™ CLIP



FTC3



FTC5

ClarkDietrich Fast Top™ clips are used in head-of-wall deflection conditions for in-fill curtain wall assemblies to provide for vertical movement. These clips are used in place of, or in combination with, deflection track. They also make a positive attachment and eliminate the need to install bridging continuously throughout the uppermost punchouts. Attach to the underside of structural members, concrete decks or floor assemblies.

Product code	Thickness			Web width (in)	Leg length (in)	Standard length (ft)	Packaging Pcs./Carton
	Gauge	Mils	Design thickness (in)				
FTC3	14	68	0.0713	4	1-1/2	3-1/4	25
FTC5	14	68	0.0713	4	1-1/2	4-3/4	30

FTC3 includes 55 FastClip™ deflection screws per box.
 FTC5 includes 110 FastClip deflection screws per box.
 U.S. Patent No. 6,688,069

Spazzer® 5400



ClarkDietrich TradeReady® Spazzer® 5400 spacer bar is a galvanized steel spacer and bridging bar, engineered to facilitate the rapid erection of exterior curtain wall framing, load-bearing walls and high interior partitions constructed of structural studs. Proprietary prepunched slots provide excellent torsional and lateral stud restraint.

Product code	Thickness			Size (in)	Packaging	
	Gauge	Mils	Design thickness (in)		Pcs./Bundle	Pcs./Skid
SPZS	16	54	0.0566	1-1/4 x 1-1/4 x 50	N/A	680

- Fast, easy and efficient
 - Reduces labor up to 40%
 - Eliminates clip angles, bridging clips and welding
 - Pre-notched at 12", 16" and 24" intervals so no layout is required
- U.S. Patent No. 6,708,460 and other patents pending.

Spazzer BAR FLY CLIP



The Spazzer fly clip is a secure, fast and efficient way to finish a wall section. This prepunched clip eliminates the need for cutting and bending when using the Spazzer 5400 spacer bar.

Product code	Size (in)	Packaging Pcs./Carton
SFLY	1 x 1-1/4 x 1	100

Spazzer Bar Guard™



Used to secure the Spazzer 5400 spacer bar when used in load-bearing applications.

Product code	Size (in)	Packaging Pcs./Carton
SPBG	3-1/4 x 1-5/8	100

Spazzer SNAP-IN GROMMET



Used to secure the Spazzer 5400 spacer bar when used in curtain wall applications.

Product code	Size (in)	Packaging Pcs./Carton
SPGR	1-1/2 x 4	100

U-CHANNEL



ClarkDietrich U-channel, combined with EasyClip™ clip angles (U-Series™) and screws, is one of the most common bridging methods used to provide resistance to stud rotation and minor axis bending under wind and axial loads. 1-1/2" U-channel is passed through the stud knockout and secured. Lateral bracing is typically installed at a maximum of 48" o.c., but consult ClarkDietrich's Technical Design Guide for proper spacing.

Product code	CSSBI Reference	Thickness			Size (in)
		Gauge	Mils	Design thickness (in)	
CHN1	075U50-54	16	54	0.0566	3/4
CHN2	150U50-54	16	54	0.0566	1-1/2

Available in 10', 16' and 20' lengths.

Caution: EasyClip clip angles must be used with screws to brace cold-formed framing properly. U-channel does not provide proper bracing if it is not adequately attached to the framing member.

SwiftClip™ L-Series™ SUPPORT CLIP



LS-Series Support Clip



LE-Series Support Clip



LA-Series Support Clip

SwiftClip™ L-Series™ support clips are used in multiple construction projects, specifically in conjunction with structural studs and track. The L-shaped clips fit between the stud flanges, so that shorter length clips do not need to be ordered. These labor time-savers include prepunched holes for quicker screw attachments, and are punched to accommodate for CRC lateral bracing connections.

Product code	Thickness			Size (in)	Common application	Packaging Pcs./Bucket
	Gauge	Mils	Design thickness (in)			
LS543	16	54	0.0566	1-1/2 x 1-1/2 x 3-1/4	CRC/Openings	300
LS683	14	68	0.0713		Openings	300
LS973	12	97	0.1017		Openings	200
LS545	16	54	0.0566	1-1/2 x 1-1/2 x 5-1/2	CRC/Openings/Joists	200
LS685	14	68	0.0713		Openings/Joists	200
LS975	12	97	0.1017		Openings/Joists	100
LS547	16	54	0.0566	1-1/2 x 1-1/2 x 7-1/4	CRC/Openings/Joists	150
LS687	14	68	0.0713		Openings/Joists	100
LS977	12	97	0.1017		Openings/Joists	100
LS549	16	54	0.0566	1-1/2 x 1-1/2 x 9-1/4	Joists	100
LS689	14	68	0.0713		Joists	100
LS979	12	97	0.1017		Joists	50
LS541	16	54	0.0566	1-1/2 x 1-1/2 x 11-1/4	Joists	100
LS681	14	68	0.0713		Joists	50
LS971	12	97	0.1017		Joists	50
LS5413	16	54	0.0566	1-1/2 x 1-1/2 x 13-1/4	Joists	50
LS6813	14	68	0.0713		Joists	50
LS9713	12	97	0.1017		Joists	25
LE543	16	54	0.0566	1-1/2 x 3 x 3-1/4	Fixed/Joists/Trusses	100
LE683	14	68	0.0713		Fixed/Joists/Trusses	100
LE973	12	97	0.1017		Fixed/Joists/Trusses	50
LE545	16	54	0.0566	1-1/2 x 3 x 5-1/2	Fixed/Joists/Trusses	100
LE685	14	68	0.0713		Fixed/Joists/Trusses	100
LE975	12	97	0.1017		Fixed/Joists/Trusses	50
LE547	16	54	0.0566	1-1/2 x 3 x 7-1/4	Fixed/Joists/Trusses	100
LE687	14	68	0.0713		Fixed/Joists/Trusses	50
LE977	12	97	0.1017		Fixed/Joists/Trusses	50
LA543	16	54	0.0566	3 x 3 x 3-1/4	Joists/Trusses	100
LA683	14	68	0.0713		Joists/Trusses	100
LA973	12	97	0.1017		Joists/Trusses	50
LA545	16	54	0.0566	3 x 3 x 5-1/2	Joists/Trusses	100
LA685	14	68	0.0713		Joists/Trusses	50
LA975	12	97	0.1017		Joists/Trusses	50
LA547	16	54	0.0566	3 x 3 x 7-1/4	Joists/Trusses	50
LA687	14	68	0.0713		Joists/Trusses	50
LA977	12	97	0.1017		Joists/Trusses	50

EXTERIOR FRAMING

EasyClip™ U-Series™ CLIP ANGLE

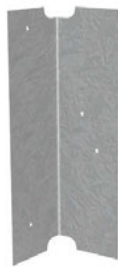

ClarkDietrich EasyClip™ U-Series™ clip angles are used to secure U-channel to wall studs for lateral bridging or for miscellaneous rigid connections. U-channel is passed through the stud knockout and an EasyClip U-Series clip is screw-attached or welded to provide a rigid connection. These clips are prepunched for faster, more accurate fastener placement. Do not use in bridging applications when the stud width exceeds 6."

Product code	Thickness			Size (in)	Packaging Pcs./Bucket
	Gauge	Mils	Design thickness (in)		
U543	16	54	0.0566	1-1/2 x 1-1/2 x 3-3/8	400
U545				1-1/2 x 1-1/2 x 5-3/4	200
U547				1-1/2 x 1-1/2 x 7-3/4	100
U549				1-1/2 x 1-1/2 x 9-3/4	100
U683	14	68	0.0713	1-1/2 x 1-1/2 x 3-3/8	200
U685				1-1/2 x 1-1/2 x 5-3/4	170
U687				1-1/2 x 1-1/2 x 7-3/4	100
U689				1-1/2 x 1-1/2 x 9-3/4	100
U973	12	97	0.1017	1-1/2 x 1-1/2 x 3-3/8	200
U975				1-1/2 x 1-1/2 x 5-3/4	130
U977				1-1/2 x 1-1/2 x 7-3/4	100
U979				1-1/2 x 1-1/2 x 9-3/4	80

DIAGONAL TENSION STRAPPING/SHEARWALL BRACING

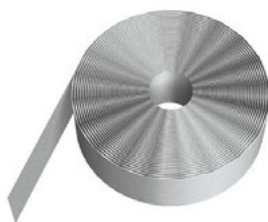

ClarkDietrich diagonal tension strapping, combined with gusset plate components, provides shearwall (racking restraint) for light-gauge, load-bearing framing under wind and seismic loads. Straps should be positioned diagonally in an X-configuration from the bottom to top track—on both sides of the wall. At a minimum, double studs at the ends of the X-brace serve as compression studs, which must be anchored to the foundation.

Product code	Thickness			Size Available	
	Gauge	Mils	Design thickness (in)	Min. width (in)	Max. width (in)
DTNC*	20	33	0.0346	2	12
	18	43	0.0451	2	12
	16	54	0.0566	2	12
	14	68	0.0713	2	12
	12	97	0.1017	2	12

*20 and 18 gauge are 33,000psi yield strength. 16, 14 and 12 gauge are 50,000psi yield strength.

Caution: Racking loads are first transferred to the roof/floor decking and then to the shearwalls (X-bracing). The X-bracing relies on a proper foundation to resist uplift and shear forces. For the system to function properly, the load path from the roof or floor deck, to the shearwalls, to the foundation must be complete.

FLAT STRAPPING



Properly spaced horizontal steel bracing provides resistance to stud rotation and minor axis buckling under wind and axial loads. Block and strapping is typically used when wall studs exceed 6". Field cut, blocking is used if knockouts do not align. It's also used as bridging when framing members are unpunched.

Product code	Thickness			Size Available		Length (ft)
	Gauge	Mils	Design thickness (in)	Min. width (in)	Max. width (in)	
DTN3	20	33	0.0346	2	12	10
	18	43	0.0451			
DTN5	16	54	0.0566	2	12	10
	14	68	0.0713			
	12	97	0.1017			

DTN3 has a yield strength of 33,000psi.
DTN5 has a yield strength of 50,000psi.

GUSSET PLATES FOR SHEARWALL BRACING



ClarkDietrich gusset plate components, combined with diagonal tension strapping, provide shearwall (racking restraint) for light-gauge, load-bearing framing under wind and seismic loads.

Product code	Thickness			Plate size (in)	Packaging Pcs./Bucket
	Gauge	Mils	Design thickness (in)		
GP	16	54	0.0566	6 x 6	25
				6 x 12	
				12 x 12	
GP	12	97	0.1017	6 x 6	25
				6 x 12	
				12 x 12	

HEAVY-DUTY STUD (HDS®) FRAMING SYSTEM



The HDS® framing system is a new, high-performance, cost-effective, multipurpose, heavy-duty framing stud for headers, jambs, posts and built-up tube truss chords and webs. The superior strength and carrying capacity mean higher performance with fewer members. The HDS framing system eliminates box beam headers, nesting track and stud for posts and jambs.

Product code	Thickness			ksi	Depth (in)	Flange (in)	Return (in)
	Gauge	Mils	Design thickness (in)				
HDS	20	33	0.0346	33	3-5/8, 6	3	1-1/16, 2-1/4
	18	43	0.0451	33			
	16	54	0.0566	50			
	14	68	0.0713	50			
	12	97	0.1017	50			

Patent pending.

L-HEADER



ClarkDietrich L-headers are prefabricated, light-gauge 90° L-sections that are used in load-bearing wall framing. They slide easily into place and eliminate the labor-intensive process of built-up field-assembled headers. Install as single, one header one side, or double, two headers, one on both sides.

Product code	Thickness			Leg length (in)
	Gauge	Mils	Design thickness (in)	
LHDR	18	43	0.0451	1-1/2 x 6
	16	54	0.0566	
	14	68	0.0713	
	18	43	0.0451	
	1-1/2 x 8	16	54	0.0566
		14	68	0.0713
		18	43	0.0451
		16	54	0.0566
1-1/2 x 10	14	68	0.0713	

Custom lengths available on request.

TradeReady® HEADER



The TradeReady® load-bearing one-piece header drastically reduces labor costs when compared to standard box beam headers constructed with C-shaped members. Pre-engineered to fit standard door and window openings, the TradeReady headers are easy and fast to install.

Product code	Thickness			Wall stud size (in)	Leg length (in)
	Gauge	Mils	Design thickness (in)		
TDHA	14	68	0.0713	3-5/8	8
				6	
TDHB	14	68	0.0713	3-5/8	12
				6	

Standard lengths are 82" and 118".
Custom sizes available on request.
U.S. Patent No. 5,689,922

FLOOR FRAMING

You can have confidence in the strength of steel under your feet.

Floor framing made from cold-formed steel is stronger and more versatile. Its high strength-to-weight ratio provides strong loading capacity and maximum spanning capability. It can be used with all traditional flooring materials such as plywood, OSB, concrete-filled steel deck or one of the many varieties of fiber-reinforced cement board. It doesn't squeak when you walk across it.

What's more is that ClarkDietrich's exclusive TradeReady® Floor System is designed with large extruded openings in the joists to accommodate electrical, mechanical, plumbing and technology lines. These prepunched openings also eliminate drilling and soffit framing during installation.

For all of these reasons, steel floor framing has become the standard for low- and mid-rise commercial structures such as hotels, apartments, condominiums and assisted living, as well as residential homes.

- Available in a variety of web sizes, flanges, gauges and yield strengths
- Pre-spaced joist tabs
- Greater spanning capabilities
- Prepunched openings
- Full system of joist components, accessories, hangers and connectors

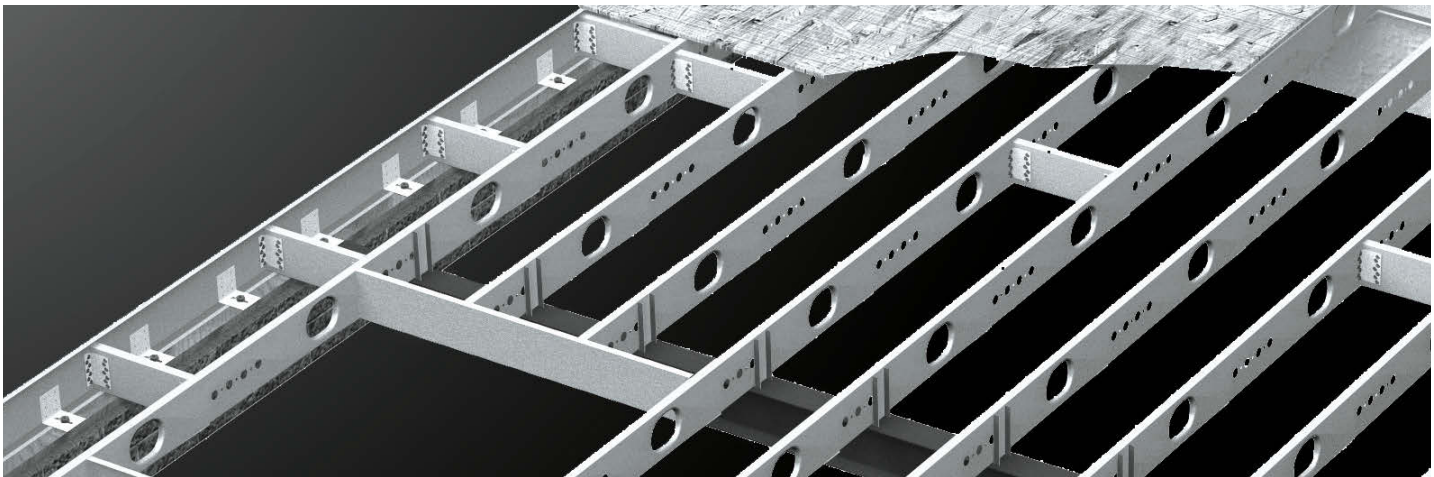

THE ClarkDietrich TradeReady® FLOOR SYSTEM

The revolutionary TradeReady Steel Joist System features a tabbed rim track to strengthen the joist against web crippling loads, and to provide greater versatility and strength for ledger applications. In conjunction with other floor sheathing products, this system provides one of the most cost-effective systems for non-combustible low- and mid-rise structures.

- Prepunched openings eliminate drilling/cutting joist webs, and soffit framing
- Sustainable alternative to wood joists, offering long-term price stability
- Pre-spaced joist tabs eliminate layout, and joist hangers
- Greater spanning capabilities for design flexibility
 - Wider o.c. spacing for fewer joists

TradeReady® STEEL JOIST



ClarkDietrich TradeReady® steel joists clear spans up to 33 feet, and are one of the primary components of the TradeReady floor system. Large extruded holes accommodate HVAC, mechanical, plumbing, electrical and sprinkler runs. The joist also features a series of smaller holes for electrical and technology lines. Hole sizes range from 4-1/4" oval to 10" round, based on member depth.

They offer consistent quality, predictable performance and high strength-to-weight ratio.

Product code*	Thickness			Depth (in)	Flange (in)	Return (in)
	Gauge	Mils	Design thickness (in)			
TDJ3 (18 gauge) TDJ5 (16, 14 & 12 gauge)	18	43	0.0451,	7-1/4	1-3/4	5/8
	16	54	0.0566,	8	1-3/4	5/8
	14	68	0.0713,	9-1/4	1-3/4	5/8
	12	97	0.1017	11-1/4	1-3/4	5/8
TDW3 (18 gauge) TDW5 (16, 14 & 12 gauge)	18	43	0.0451,	10	2	5/8
	16	54	0.0566,	12	2	5/8
	14	68	0.0713,	14	2	5/8
	12	97	0.1017			

* 18 gauge is standard as 33ksi yield strength.

16, 14 and 12 gauge are standard as 50ksi yield strength.

UL and UL Classified are trademarks of Underwriter's Laboratories, Inc.

UL listed assemblies L564, G535, G536, G551, G553 and G560.



TradeReady Joist

Hole size (in)	Hole shape	Web width (in)
4-1/4 x 7		7-1/4 TDJ, 8 TDJ
6-1/4 x 9		9-1/4 TDJ, 10 TDW, 11-1/4 TDJ
8 Diam.		12 TDW
10 Diam.		14 TDW

TradeReady RIM



Another major component of the TradeReady floor system, the standard 16'-long rim drastically reduces framing time and effort. Rims have pre-formed, prepunched attachment tabs at 12", 16", 19.2" or 24" o.c. spacing to eliminate layout time—and ensure fast, proper fastener placement. Embossed stiffening ribs on each side of the tabs provide additional reinforcement, for a significant reduction of web stiffeners (squash blocks) and support clips in a majority of applications.

Product code	Thickness			Depth (in)	Flange Length		Tab spacing (in)
	Gauge	Mils	Design thickness (in)		Top (in)	Bottom (in)	
TD12, TD16, TD19, TD24	18, 16, 14, 12	43, 54, 68, 97	0.0451, 0.0566, 0.0713, 0.1017	7-1/4	1-1/4	2-1/2	12
				8			
				9-1/4			
				10			
				11-1/4			
				12			
14							

U.S. Patent Nos. 6,301,854; 6,691,478; 6,418,694; 6,691,487; 6,761,005; 7,240,459
 Canadian Patent No. 2319346
 Mexican Patent No. 243294

TradeReady® STRUCTURAL BLOCKING



The third component of the TradeReady® Floor System, TradeReady structural blocking is pre-cut to fit securely between the underside of the floor joists to prevent joist rotation. Prepunched for quick attachment, it's an economical alternative to cross bracing, X-bracing or strapping. For easy attachment, install continuous row of blocking every 8' o.c. maximum, and staggered.

Product code	Thickness			Depth (in)	Effective length (in)	Packaging Pcs./Bundle
	Gauge	Mils	Design thickness (in)			
TDSB	18	43	0.0451	2-1/2	12	10
TDSB					16	
TDSB					19.2	
TDSB					24	

Note: TDSB blocking is not required if sheathing is applied to the joists top and bottom.

Caution: To prevent joist rolling, TDSB blocking must be tied into the structure or otherwise braced against lateral movement.

EasyClip™ QuickTwist™ WEB STIFFENER



EasyClip™ QuickTwist™ web stiffeners are used to provide reinforcement of joist webs to prevent crippling. Web reinforcement is often required by design to enhance the load capacity of joists. The unique design of QuickTwist allows the installer to insert the stiffener on the inside of the joist *after* the joist is installed. This stiffener eliminates the need to pre-insert traditional web stiffeners prior to joist installation. The one-piece assembly is easily rotated in-place for a tight fit.

Product code	Size (in)	Thickness			Height* (in)	Packaging
		Gauge	Mils	Design thickness (in)		
QTWS	3-1/2	12	97	0.1017	7-1/4	Dependent on order quantity
					8	
					9-1/4	
					10	
					11-1/4	
					12	
QTWS	6	12	97	0.1017	7-1/4	Dependent on order quantity
					8	
					9-1/4	
					10	
					11-1/4	
					12	

*Dimension is nominal size. Actual product is shorter to fit inside joist.

LIGHT-GAUGE C-JOIST FRAMING



ClarkDietrich C-joist components provide an economical, lightweight alternative to open web trusses, bar joists, engineered lumber, cast-in-place or hollow core floor assemblies. Plus, they're pre-cut to save time. Depending on loads and spans, C-joists are typically spaced at 12", 16", 19.2" or 24" o.c. Joist-to-girder attachments are normally supported with joist hangers, EasyClip E-Series™ or S-Series™ support clips. Web stiffeners may be required at supports and other point loads.

Product code*	Member	Thickness			Depth (in)	Flange (in)	Return (in)
		Gauge	Mils	Design thickness (in)			
CSJ	800S162-x	18	43	0.0451	8	1-5/8	1/2
	1000S162-x	16	54	0.0566	10		
	1200S162-x	14	68	0.0713	12		
	1400S162-x	12	97	0.1017	14		
CSW	800S200-x	18	43	0.0451	8	2	5/8
	1000S200-x	16	54	0.0566	10		
	1200S200-x	14	68	0.0713	12		
	1400S200-x	12	97	0.1017	14		
CSE	800S250-x	18	43	0.0451	8	2-1/2	5/8
	1000S250-x	16	54	0.0566	10		
	1200S250-x	14	68	0.0713	12		
	1400S250-x	12	97	0.1017	14		
CSS	800S300-x	18	43	0.0451	8	3	1
	1000S300-x	16	54	0.0566	10		
	1200S300-x	14	68	0.0713	12		
	1400S300-x	12	97	0.1017	14		

18 gauge is standard as 33ksi yield strength. 16, 14, and 12 gauge are standard as 50ksi yield strength.

STRUCTURAL TRACK



Structural track, usually in the same gauge as the joist, is used as rim or band enclosures.

Product code	Member	Thickness			Depth (in)	Flange (in)
		Gauge	Mils	Design thickness (in)		
TSB	800T125-x	18	43	0.0451	8	1-1/4
	1000T125-x	16	54	0.0566	10	
	1200T125-x	14	68	0.0713	12	
	1400T125-x	12	97	0.1017	14	

18 gauge is standard as 33ksi yield strength. 16, 14, and 12 gauge are standard as 50ksi yield strength.

Depth of TSB is measured to the inside of the flanges.

WEB STIFFENER



ClarkDietrich web stiffeners are used to provide reinforcement of joist webs to prevent crippling. Web reinforcement is often required by design to enhance the load capacity of joists. When installing between the joist flanges, a web stiffener must be installed by sliding it in from the end of the joist.

Product code	Thickness			Size (in)	Length (in)
	Gauge	Mils	Design thickness (in)		
WS	14	68	0.0713	4	5-3/4 to 13-3/4

DIAGONAL TENSION STRAPPING



Block and strap bridging helps prevent joist rotation and lateral movement. Solid blocking, a field-cut track or joist section, is welded or screw-attached between the first and last two outer joist bays—at a maximum of 8' o.c. along the strap—over all interior supports and adjacent to floor openings. Two-inch-wide corrosion-resistant strapping is also screw-attached or welded to the bottom of every joist flange. For sub-floor or decking without lateral support, install strap on the top flange of the joist.

Product code	Thickness			Size Available (in)		Length (ft.)
	Gauge	Mils	Design thickness (in)	Min. width	Max. width	
DTN3	20	33	0.0346	2	12	10
	18	43	0.0451			
DTN5	16	54	0.0566	2	12	10
	14	68	0.0713			
	12	97	0.1017			

DTN3 has a yield strength of 33,000psi.
 DTN5 has a yield strength of 50,000psi.
 Packaging may vary by region.

EasyClip™ E-Series™ SUPPORT CLIP



ClarkDietrich EasyClip™ E-Series™ support clips are used for rigid standoff connections. The 4" wide leg provides extra length to achieve standoff connections up to 3." These support clips are commonly used in bypass wall conditions, a variety of floor framing applications including solid and ladder blocking attachments and joist-to-joist connections, and to secure rafter framing to the primary structure. EasyClip E-series support clips are prepunched for faster and more accurate fastener placement.

Product code	Thickness			Size (in)	Packaging Pcs./Bucket
	Gauge	Mils	Design thickness (in)		
E543	16	54	0.0566	4 x 1-1/2 x 3	100
E545				4 x 1-1/2 x 5	100
E547				4 x 1-1/2 x 7	100
E549				4 x 1-1/2 x 9	50
E541				4 x 1-1/2 x 11	50
E683	14	68	0.0713	4 x 1-1/2 x 3	100
E685				4 x 1-1/2 x 5	100
E687				4 x 1-1/2 x 7	80
E689				4 x 1-1/2 x 9	50
E681				4 x 1-1/2 x 11	50
E973	12	97	0.1017	4 x 1-1/2 x 3	50
E975				4 x 1-1/2 x 5	50
E977				4 x 1-1/2 x 7	50
E979				4 x 1-1/2 x 9	50
E971				4 x 1-1/2 x 11	40

EasyClip S-Series™ SUPPORT CLIP



ClarkDietrich EasyClip S-Series™ support clips are commonly used for rigid connections in window and door framing, joist, bypass or other miscellaneous connections to secure one framing member to another, or to secure framing members to the structural frame. This high-performance multi-use utility clip is ideal for corner reinforcements, stair openings and numerous support applications. EasyClip S-Series clips are prepunched for faster and more accurate fastener placement.

Product code	Thickness			Size (in)	Packaging Pcs./Bucket
	Gauge	Mils	Design thickness (in)		
S543	16	54	0.0566	1-1/2 x 1-1/2 x 3	400
S545				1-1/2 x 1-1/2 x 5	200
S547				1-1/2 x 1-1/2 x 7	100
S549				1-1/2 x 1-1/2 x 9	100
S541				1-1/2 x 1-1/2 x 11	100
S683	14	68	0.0713	1-1/2 x 1-1/2 x 3	200
S685				1-1/2 x 1-1/2 x 5	200
S687				1-1/2 x 1-1/2 x 7	100
S689				1-1/2 x 1-1/2 x 9	100
S681				1-1/2 x 1-1/2 x 11	100
S973	12	97	0.1017	1-1/2 x 1-1/2 x 3	200
S975				1-1/2 x 1-1/2 x 5	150
S977				1-1/2 x 1-1/2 x 7	100
S979				1-1/2 x 1-1/2 x 9	80
S971				1-1/2 x 1-1/2 x 11	70

TENSION BRACING



Tension bracing is used to prevent joist compression, flange lateral movement, and rotation. These tension ties are an alternative to traditional block and strapping. Traditionally used with wood framing, ties can also be used with conventional C-joists.

As a general rule, floor bracing or bridging is installed at 8' o.c. maximum.

Product code	Thickness			Size (in)	Packaging Pcs./Bundle
	Gauge	Mils	Design thickness (in)		
T20	20	33	0.0346	3/4 x 20	50
T27				3/4 x 27	
T36				3/4 x 36	

Simpson® Strong-Tie® JOIST HANGER



Providing maximum installation flexibility, this universal hanger can be used for 8"-14" deep wood or steel framing members. It's easily field skewable and can accommodate up to 45° attachments. Floor joists can be attached from either side or easily doubled up.

Product code	Simpson reference	Thickness			Packaging Pcs./Carton
		Gauge	Mils	Design thickness (in)	
S/JCT	S/JCT8-14	14	68	0.0713	50
S/JCT	S/HJCT	12	97	0.1017	

U.S. Patent No. 6,230,467 of Simpson Strong-Tie Company.

Simpson® and Simpson Strong-Tie® are registered trademarks of the Simpson Strong-Tie Company, Inc.

BRIDLE HANGER



Bridle hangers are commonly used to attach light-gauge C-joists to structural steel beams, wood ledgers or masonry block. Connections can be made with screws, powder-actuated fasteners, drill-in concrete anchors or welding. Single- and double-wide hangers are also available in other widths and depths. The MB hanger can also be sloped to a maximum of 45°. Skew only: MB series can be skewed to a maximum of 45°—maximum allowable download is 62% of table load.

Product code	Thickness			Depth (in)	Width (in)	Packaging Pcs./Carton
	Gauge	Mils	Design thickness (in)			
CDBV	14	68	.p0.0713	8	2	25
				10		
				12		
				14		
CDMB	12	97	0.1017	8	2	25
				10		
				12		
				14		

MB: Slope 0° to 30°, maximum allowable download is 100% of table load.

Slope 31° to 45°, maximum allowable download is 80% of table load.

Simpson Strong-Tie SKEWABLE ANGLE



SLS5

Simpson® Strong-Tie® skewable angles are used to make rigid attachments of joist-to-joist or joist-to-other miscellaneous framing. This clip is ideal for making off-angle attachments. It is easily field bent from 0° to 135°.

CAUTION: This clip can only be bent one time.



SLS7

Product code	Thickness			Size (in)	Packaging Pcs./Carton
	Gauge	Mils	Design thickness (in)		
SLS5	18	43	0.0451	4-7/8	100
SLS7				6-3/8	50

ICBO ER #5275 recognized.

Simpson® and Simpson Strong-Tie® are registered trademarks of the Simpson Strong-Tie Company, Inc.

INTERIOR FINISHING

Occupants never see the effort put into building the wall. They only see the finish.

ClarkDietrich offers an unmatched selection of interior finishing products—all designed for durability and finesse.

Paper-faced metal beads and trims combine galvanized metal with high-grade paper tape to provide cost-effective, problem-free, compound-embedded drywall finishing. Our products allow the joint compound applied to the underside to seep through perforations in the paper to provide superior adhesion and bonding to gypsum. Corner and edge cracking are virtually eliminated because beads float with the gypsum, independent of framing movement or settling.

- Smoothest finish available
- Tape-on products provide superior adhesion and bonding
- Enhanced paintability

Traditional metal drywall beads and trims provide crisp, clean and straight protection for gypsum wallboard construction. Available in a wide selection of products and sizes, metal is the versatile choice for almost any

drywall finish condition. Metal beads and trims can be nailed, screwed, stapled or clinched in place and finished with joint compound. They are low-cost, easily applied and provide high-quality, long-lasting professional finishes.

- Strong; dent- and impact-resistant
- Precision manufactured ensuring straight, sharp and crisp edges and corners
- Corrosion-resistant

Vinyl beads and trims are designed to provide superior, long-lasting interior finishes for drywall and veneer plaster. Vinyl offers architects, interior designers and contractors much more flexibility to create dramatic, sweeping arches, curvatures and distinctive architectural details. Vinyl also provides superior expansion and contraction properties as the products become embedded in the substrate prior to coating and, therefore, actually move with the building through temperature changes.

- Durable; impact-, corrosion- and ignition-resistant
- Superior expansion and contraction properties
- Excellent paint adhesion, no priming required

GOLDLINE® PAPER-FACED TAPE-ON BEADS

Goldline® paper-faced tape-on beads combine galvanized metal corner and edge protection with high-grade paper tape to provide cost-effective, problem-free outside drywall corner finishing. They're available in a number of different widths to suit most wallboard applications. Wider flange beads are used to cover imperfect corners, while shorter flanges are used to achieve maximum efficiency.

- Substantially reduces joint compound consumption and eliminates one finish coat
- Does not require nails, staples, screws or crimps
- Impervious to “scuffing” and “fluffing-up”
- Will not be damaged by sanding
- Superior adhesion, bonding and paintability

Notes:

GOLDLINE® and PLATINUM® are registered trademarks of Bailey Metal Products, Ltd.

GOLDLINE® Trims are covered under the following patents:

- USA 5,836,122 and 5,613,335
- Canada 2,212,854
- Australia 69582
- New Zealand 302378

PLATINUM® Trims (separate patent) are covered under the following:

- USA 7,214,434 B2
- Canada 2,417,325
- Australia 2004202648
- New Zealand 533606

PAPER-FACED METAL OUTSIDE CORNER, TAPE-ON BEAD



Goldline® superior 90° outside corner drywall finishing tape-on bead virtually eliminates corner cracks, edge chips and nail pops. Applied using joint compound, the beads don't require mechanical fasteners. Helps reduce labor and material costs by reducing the amount of joint compound needed, and also eliminating one pass of finishing.

Product code	USG reference	Style	Dimensions (in)				Standard length (ft)
			A	B	C	D	
P1WO	B1W	Standard Leg	1/2	3/4	7/8	7/8	8, 10
P1UO	B1EL	Equal Leg	3/4	3/4	3/4	3/4	
P1XW	B1XW	Extra Wide	7/8	5/8	5/8	3/4	
P1XU	B1XW EL	Extra Wide Equal	7/8	7/8	5/8	5/8	
P1SU	B1 Super Wide	Super Wide Equal	1-1/8	1-1/8	5/8	5/8	

Other lengths are available.

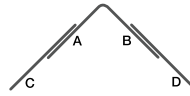

PAPER-FACED METAL OFF-ANGLE CORNER, TAPE-ON BEAD



Goldline off-angle tape-on bead, also known as splayed or 120/135° corner bead, is used to provide a strong, smooth finish for outside off-angle drywall intersections. Applied in the same manner as 90° paper bead, the result is a clean, crisp, durable off-angle corner that will not crack or chip.

Product code	USG reference	Style	Dimensions (in)				Standard length (ft)
			A	B	C	D	
P100	B1 OS	Off-Angle	1/2	3/4	5/8	5/8	8, 10

Other lengths are available.

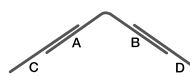

PAPER-FACED INSIDE CORNER, TAPE-ON BEAD



Goldline tape-on inside 90° paper-faced corner bead provides very straight and precise inside corners. The rigid, steel-reinforced inside corners provide a durable guide to achieve exceptionally straight and sharp inside corners. Embed in joint compound and press firmly into place. Remove excess compound with a drywall knife.

Product code	USG reference	Style	Dimensions (in)				Standard length (ft)
			A	B	C	D	
P2I	B2	Standard Angle	3/8	3/8	5/8	5/8	8, 10

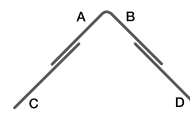

PAPER-FACED METAL OFF-ANGLE INSIDE CORNER, TAPE-ON BEAD



Goldline off-angle tape-on 120/135° inside (or reverse splayed) bead is used to achieve a crisp, clean, straight-finished inside off-angle drywall finish. This bead can be used for inside corner angles between 120° and 135°. As with all tape-on beads, off-angle bead is applied using joint compound. No mechanical fasteners are required.

Product code	USG reference	Style	Dimensions (in)				Standard length (ft)
			A	B	C	D	
P20I	B2 OS	Off-Angle	5/8	5/8	5/8	5/8	8, 10

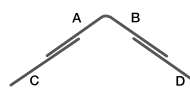

PAPER-FACED 3/4" BULLNOSE OUTSIDE CORNER, TAPE-ON BEAD



Goldline® 3/4" tape-on bullnose corner bead is used to create a smooth, rounded look to standard drywall corners. It adds contemporary styling and a sense of openness to any room. Apply in the same manner as all other tape-on beads. Gypsum boards must be cut back 3/4" to accommodate the bullnose and ensure a flush fit.

Product code	USG reference	Style	Dimensions (in)			Standard length (ft)
			A	B	C	
P1BO	SLOC	Standard	7/8	3/4	7/8	8, 10

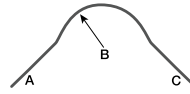

PAPER-FACED 3/4" BULLNOSE OFF-ANGLE OUTSIDE CORNER, TAPE-ON BOARD



Goldline off-angle bullnose tape-on bead (also known as splayed bullnose or 120°/135° bullnose corner bead), is used to provide a rounded, bullnose finish for off-angle drywall intersections. It is applied in the same manner as 90° paper bead. Gypsum board must be cut back 3/4" to accommodate the bullnose and ensure a flush fit.

Product code	USG reference	Style	Dimensions (in)			Standard length (ft)
			A	B	C	
P0BO	SLOC OS	Off-Angle	1	3/4	1	8, 10

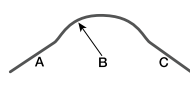

PAPER-FACED 3/4" BULLNOSE OUTSIDE CORNER, NAIL-ON BEAD



Goldline 3/4" nail-on bullnose corner bead is used to create a smooth, rounded look to standard drywall corners. Nail-on bullnose adds contemporary styling and a sense of openness to any room. Nails or mechanical fasteners are used to secure the bead to the wallboard.

Product code	USG reference	Style	Dimensions (in)			Standard length (ft)
			A	B	C	
P1BN	SLOC N	Standard	5/8	3/4	5/8	8, 10

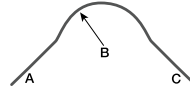

PAPER-FACED 3/4" BULLNOSE OFFSET OUTSIDE CORNER, NAIL-ON BEAD



Goldline off-angle nail-on bullnose bead, also known as splayed bullnose or 120°/135° bullnose corner bead, is used to provide a rounded bullnose finish for outside off-angle drywall intersections. Nails or mechanical fasteners are used to secure the bead to the wallboard.

Product code	USG reference	Style	Dimensions (in)			Standard length (ft)
			A	B	C	
P00B	SLOC NOS	Off-Angle	5/8	3/4	5/8	8, 10

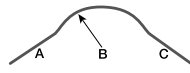

PAPER-FACED INNER COVE, TAPE-ON TRIM



Goldline® tape-on inner cove 90° paper-faced bead provides subtle, rounded inside or inner corners. Inner cove tape-on beads are embedded in joint compound and pressed firmly into place. Excess compound is removed with a drywall knife or wiped clean with a rag.

Product code	USG reference	Style	Dimensions (in)			Standard length (ft)
			A	B	C	
P2BI	SLIC	Standard	5/8	3/4	5/8	8, 10

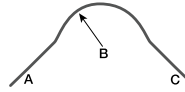

PAPER-FACED METAL L, TAPE-ON TRIM



Goldline L-trims are used to finish the ends of wallboard where it abuts dissimilar surfaces, such as suspended ceilings, beams, plaster, masonry or untrimmed door and window jambs. Applied in the same manner as all other tape-on beads—joint compound embeds the paper-faced bead to the wallboard paper.

Product code	USG reference	Style	Dimensions (in)			Standard length (ft)
			A	B	C	
P4L	B4	3/8	7/16	1-11/16	1-1/4	10
	B4	1/2	9/16	15/16	1-1/4	
	B4	5/8	11/16	1-1/16	1	



PAPER-FACED METAL REVEAL, TAPE-ON TRIM



Goldline reveal trims are used to finish wallboard terminations when the board abuts other building materials—such as suspended ceilings, beams and untrimmed door and window jambs—to create a clean step inset or reveal. Helps create aesthetic architectural detailing around light fixtures, ceilings, walls and soffits, without mechanical fasteners.

Product code	USG reference	Style	Dimensions (in)				Standard length (ft)
			A	B	C	D	
PGR	B4 NB Reveal (1/2")	1/2 x 1/2	1/2	1/2	1-3/16	7/8	10
	B4 NB Reveal (5/8")	5/8 x 5/8	5/8	5/8	15/16	7/8	

103 Deluxe® CORNER BEAD



ClarkDietrich 103 Deluxe® corner bead is considered the premier drywall finishing corner bead product. This product combines a unique manufacturing process, with specially enhanced steel to provide consistent, high-quality finishing, and solid protection at drywall corners, every time. Nail, staple, screw or clinch into place.

Product code	Size	
	Width (in)	Length
CBU (dull finish)	1-1/4 x 1-1/4	6' 9"
		6' 10"
		7' 0"
		8' 0"
		9' 0"
		10' 0"
		12' 0"

Quicksilver™ CORNER BEAD



Quicksilver™ corner bead is a hot-dipped, highly durable galvanized bead that offers superior corrosion protection. This bead is ideal for humid, moisture-prone conditions and high-traffic areas subject to more than normal abuse. Quicksilver corner bead provides a high-quality finish and solid protection at drywall corners.

Product code	Size	
	Width (in)	Length
CBS (shiny finish)	1-1/4 x 1-1/4	6' 9"
		6' 10"
		7' 0"
		8' 0"
		9' 0"
		10' 0"
		12' 0"

CLINCH-ON PRODUCTS, CO. CORNER BEAD/DULL



Clinch-On corner bead is recognized as the premier product for providing sturdy metal reinforcement on 90° drywall corners. Knurled and perforated flanges offer superior compound adhesion for smooth, straight finishes. Corner bead attachments are accomplished by nailing, stapling, screwing or clinching through the flanges.

Product code	Size	
	Width (in)	Length
CBCO (dull gray)	1-1/4 x 1-1/4	6' 0"
		6' 9"
		6' 10"
		7' 0"
		8' 0"
		9' 0"
		10' 0"
		12' 0"

Not available in all geographic areas.

CLINCH-ON PRODUCTS, CO. CORNER BEAD/HOT-DIPPED



Clinch-On hot-dipped corner bead offers the identical roll-formed precision as its counterpart. Hot-dipped galvanized metal corner bead (meets ASTM A1047) provides enhanced corrosion protection and sturdy reinforcement at exposed 90° corners. Flanges are knurled and perforated to ease joint compound adhesion and nail attachment.

Product code	Size	
	Width (in)	Length
CBCS (shiny)	1-1/4 x 1-1/4	6' 9"
		7' 0"
		8' 0"
		9' 0"
		10' 0"
		12' 0"

Not available in all geographic areas.

SPLAYED CORNER BEAD



ClarkDietrich's 120/135° corner bead, also referred to as splayed or off-angle bead, provides a clean, crisp finished look at off-angle intersections. Specially enhanced steel for corrosion protection and superior compound adhesion, it's easy to attach and finish.

Product code	Size	
	Width (in)	Length (ft)
CB12 (dull finish)	1-1/4 x 1-1/4	8
		10

BULLNOSE 90° CORNER BEAD



ClarkDietrich bullnose corner bead is used to create a smooth, rounded look to standard drywall corners. Of rugged steel construction, bullnose 90° corner bead is designed for superior compound adhesion. Just nail, screw or staple in place. Available with a galvanized finish meeting ASTM C1047 or with a prime-painted surface for shadow-free finishing.

Product code	Size	
	Radius (in)	Length
CBB	3/4	7' 0"
		8' 0"
		8' 6"
		9' 0"
		10' 0"
		10' 6"

BULLNOSE SPLAYED 135° CORNER BEAD



ClarkDietrich splayed or off-angle bullnose is used to create a smooth rounded look at 135° corners. Bullnose adds contemporary styling, but also performs with corrosion protection and durability. Available with a galvanized finish conforming to ASTM C1047 or prime-painted surface for shadow-free finishing.

Product code	Size	
	Radius (in)	Length
CBBW	3/4	8' 0"
		8' 6"
		9' 0"
		10' 0"
		10' 6"

BULLNOSE KERFED BEAD



ClarkDietrich kerfed bullnose has a distinctive shortened back flange allowing for insertion into grooved door jambs and window trims. This feature provides for efficient, clean installation, as well as the smooth round appearance associated with bullnose trims. Roll-formed from galvanized steel, it conforms to ASTM A1047 for added durability and protection from corrosion.

Product code	Size	
	Radius (in)	Length (ft)
CBBK	3/4	7
		8
		9
		10
	1-1/2	7
		10

2-WAY INSIDE 3/4" BULLNOSE CORNER CAP 90°



ClarkDietrich vinyl 2-way 3/4" corner caps provide the ideal component to transition bullnose corner beads to a crisp finish where inside corners intersect at 90°. Examples of applications include windows, closets, doorways, skylights, etc. Easy to install, this component provides a cost-effective alternative to time-consuming mitering of corners.

Product code	Style	Size radius (in)	Packaging	
			Pcs./Box	Cartons/Skid
M285	Plastic 2-way corner cap	3/4	50	25

3-WAY 3/4" BULLNOSE CORNER CAP 90°



ClarkDietrich 3-way 3/4" bullnose 90° corner caps provide the ideal solution to finish corners quickly and efficiently at 3-way intersections. Features extended tabs for easier alignment and a professional finish. Works well with both metal and vinyl bullnose corner beads, eliminating the need for special corner bead applications and mitering.

Product code	Style	Size radius (in)	Packaging	
			Pcs./Box	Cartons/Skid
M385	Plastic 3-way corner cap	3/4	50	25



BULLNOSE TO 90° TRANSITION CAP



ClarkDietrich bullnose corners to 90° transition caps simplify installation of baseboard or crown molding corners into 3/4" bullnose systems. Quick and easy to install, this product eliminates corner gaps and the need for time-consuming caulking and filling. Use with metal or vinyl 3/4" bullnose corner bead for transition onto baseboard or crown molding up to 4-1/2" wide.

Product code	Style	Radius (in)	Packaging	
			Pcs./Box	Cartons/Skid
M859	Bullnose to 90° transition cap	3/4	50	25

METAL J-TRIM



ClarkDietrich metal J-trim is a strong, reveal-type galvanized steel casing that provides maximum corrosion protection and neat finished edges to drywall terminations around door and window openings. It also delivers a clean trim line at intersections or where gypsum panels abut dissimilar surfaces, such as columns and window mullions. Hemmed edges allow quick installation and do not require joint compound.

Product code	Size	
	Width (in)	Length (ft)
M400	3/8	8
		10
M401	1/2	8
		10
M402	5/8	8
		10

METAL U-TRIM/SPACKLE J



ClarkDietrich U-trim, or Spackle J, provides maximum protection and clean finished edges on gypsum panels around door and window openings, and when wallboard abuts dissimilar surfaces, such as suspended ceilings, beams, plaster, masonry and concrete. It's easily installed by sliding trim over the edge of the board and nailing/ screwing through the knurled (long) flange—which also enhances compound adhesion.

Product code	Size	
	Width (in)	Length (ft)
M20A	1/2	8
		10
	5/8	8
		10

METAL L-TRIM



ClarkDietrich metal L-trim provides a clean finished edge at door and window openings or when wallboard abuts dissimilar surfaces, such as suspended ceilings, beams, plaster, masonry and concrete. Installed after the gypsum panels are already in place—unlike Spackle J which must be installed during gypsum panel installation—L-trim is easily attached with screws or nails. A hemmed front flange provides rigidity.

Product code	Size	
	Width (in)	Length (ft)
M20B	1/2	8
		10
	5/8	8
		10

093 ZINC CONTROL JOINT



ClarkDietrich 093 zinc control joint is applied between abutting gypsum panels, and is used to relieve stresses of expansion and contraction of drywall and veneer plaster systems in large ceiling and wall expanses over 30' in length. It's typically installed from door header to ceiling, from floor to ceiling in long partition runs, and from wall to wall in large ceiling areas—and for interior or exterior applications.

Product code	Size	
	Grounds (in)	Length (ft)
ZNCJ	3/32	10

Note: Where fire and sound control are prime considerations, an approved seal must be installed behind the control joint.

Mini-Bead™ 800 AND 900 CORNER BEAD



ClarkDietrich Mini-Bead™ 800 and 900 corner bead are galvanized steel reinforcements for interior, outside corner, veneer or thin wall plaster applications. Mini-Bead 800 has 1/16" grounds for one-coat veneer plaster and 90 keys per linear foot for excellent bonding and strong corners. Mini-Bead 900 has 3/32" grounds for two-coat veneer plaster systems.

Product code	Size		
	Grounds (in)	Width (in)	Length (ft)
MB80 (galvanized)	1/16	1-1/4 x 1-1/4	8
			10
MB90 (galvanized)	3/32	1-1/4 x 1-1/4	8
			10
ZB80 (zinc)	1/16	1-1/4 x 1-1/4	10
ZB90 (zinc)	3/32	1-1/4 x 1-1/4	10

VINYL CORP.

The finest accessories. The best customer experience. For years, these have remained the hallmarks of Vinyl Corp.'s business. Today, as a wholly owned subsidiary of ClarkDietrich, Vinyl Corp. continues to lead the way with innovations for stucco, plaster, drywall, veneer and EIFS/ DEFS PB and PM applications.

At Vinyl Corp., quality begins with products derived from superior ingredients. In fact, a commitment to using only lead-free virgin vinyl compounds means you can count on excellent products that function without question and meet or exceed all applicable specifications. Add to this a set of exacting manufacturing tolerances, which translates into products that are easy to fit and form every time, every job.

No matter how good the product, inconsistent delivery and poor support can be costly. That's why Vinyl Corp. works equally as hard to maintain a reputation for customer service. From 24-hour turnaround on orders, to in-house expertise, to comprehensive technical support materials, Vinyl Corp. excels at keeping projects moving forward.

Like ClarkDietrich, Vinyl Corp. is a progressive company with a vision for the future. Together, we're better able to deliver innovative products that save finishing time, materials and labor costs—while heightening aesthetic appeal.

For more information, visit vinylcorp.com



VINYL CORNER BEAD



Vinyl corner bead is a rigid, easy-to-apply 90° corner reinforcement that nails or staples into place. Multiple perforations along the flanges enhance bonding. The pronounced nose provides a ground and screed to help achieve precise finishing depth. It's easily cut, dent-resistant, rustproof and maintains shape, with no sharp edges or burrs when field cut.

Product code	Size	
	Width (in)	Length (ft)
VLCB	1-1/4 x 1-1/4	8
		10

VINYL SPLAYED CORNER BEAD 120/135°



ClarkDietrich 120/135° corner or splayed bead is used to finish off angle interior corners from 120–135°. Designed to provide straight, rustproof, dent-resistant corners, its flexibility allows a flush fit on many unusual outside wallboard intersections. Multiple perforations along the flanges enhance joint compound bonding.

Product code	Size	
	Width (in)	Length (ft)
VLSB	1-1/4 x 1-1/4	8
		10





VINYL ARCHWAY CORNER BEAD



ClarkDietrich vinyl archway corner bead fits almost any arch, curve or radius to provide rigid corner and edge protection. The notched single flange adapts to virtually any radius condition. Multiple perforations along flanges and notches enhance joint compound bonding. In addition to nails or staples, use an adhesive to secure arch tabs to gypsum board.

Product code	Size	
	Width (in)	Length (ft)
VLAB	1-1/4 x 1-1/4	8
		10

VINYL BULLNOSE 90° CORNER BEAD



ClarkDietrich vinyl bullnose corner bead is used to create a smooth, rounded look to standard drywall corners. Vinyl bullnose adds contemporary styling and a sense of openness to any room. Ideal in children's play areas, it easily installs with nails, screws or staples. It's also rustproof and dent-resistant.

Product code	Size	
	Radius (in)	Length (ft)
VBCB 90° Bullnose	3/4	8
		10
	1-1/2	8
		10

VINYL BULLNOSE SPLAYED 120/135° CORNER BEAD



ClarkDietrich vinyl bullnose splayed corner bead is used to finish off-angle interior corners from 120–135° when a rounded “bullnose” look is desired. This durable trim product is dent-resistant, rustproof and easily finished. Multiple elongated perforations along both flanges enhance joint compound bond.

Product code	Size	
	Radius (in)	Length (ft)
VBSB	3/4	8
		10
	1-1/2	8
		10

VINYL BULLNOSE KERFED CORNER BEAD



Vinyl bullnose kerfed corner bead has a distinctive shortened back flange, allowing for insertion into grooved door jambs and window trims. Provides for efficient, clean installation, as well as a smooth, rounded appearance. It's dent-resistant, rustproof and maintains shape with no sharp edges or burrs when field cut. A cost-effective alternative to expensive wood trims.

Product code	Size	
	Radius (in)	Length (ft)
VBKB	3/4	8
		10
	1-1/2	8
		10



VINYL BULLNOSE ARCHWAY CORNER BEAD



ClarkDietrich vinyl bullnose archway corner bead provides a rounded, contemporary look to archways, curves or just about any radius. Notched flanges enable it to be arched to an inside or outside radius. Secure each tab on the archway bead with adhesive or staples before application of joint compound.

Product code	Size	
	Radius (in)	Length (ft)
VBAB	3/4	8
		10
	1-1/2	8
		10

VINYL 2-WAY INSIDE 3/4" BULLNOSE CORNER CAP 90°



ClarkDietrich vinyl 2-way 3/4" corner caps provide the ideal component to transition bullnose corner beads to a crisp finish where inside corners intersect at 90°. Examples of applications include windows, closets, doorways, skylights, etc. Easy to install, this component provides a cost-effective alternative to time-consuming mitering of corners.

Product code	Style	Radius (in)	Packaging	
			Pcs./Box	Cartons/Skid
M285	Plastic 2-way corner cap	3/4	50	25

VINYL 3-WAY 3/4" BULLNOSE CORNER CAP 90°



ClarkDietrich 3-way 3/4" bullnose 90° corner caps provide the ideal solution to finish corners quickly and efficiently at 3-way intersections. Features extended tabs for easier alignment and a professional finish. Works well with both metal and vinyl bullnose corner beads, eliminating the need for special corner bead applications and mitering.

Product code	Style	Radius (in)	Packaging	
			Pcs./Box	Carton/Skid
M385	Plastic 3-way corner cap	3/4	50	25

VINYL 3/4" BULLNOSE TO 90° TRANSITION CAP



ClarkDietrich bullnose to 90° transition caps simplify installation of baseboard or crown molding corners into 3/4" bullnose systems. Quick and easy to install, they eliminate corner gaps and the need for time-consuming caulking and filling. Use with metal, vinyl or paper-faced 3/4" bullnose corner bead for transition onto baseboard or crown molding up to 4-1/2" wide.

Product code	Style	Radius (in)	Packaging	
			Pcs./Box	Carton/Skid
M859	Bullnose to 90° transition cap 3/4"	3/4	50	25

VINYL J-BEAD



ClarkDietrich vinyl J-bead provides a finished edge at gypsum board stops around door and window openings and at ceiling intersections. Requires no joint compound. Rigid vinyl is not a thermal transmitter and helps stop condensation where gypsum board terminates at exterior metal surfaces, such as window frames and mullions. Rustproof and dent-resistant.

Product code	Size	
	Width (in)	Length (ft)
VLJB	1/2	8
		10
	5/8	8
		10

VINYL MUDABLE J-BEAD



Mudable J-bead is used to cover and protect exposed ends of gypsum panels that abut other substrates like masonry, glass and metal frames. Raised shoulder and extensive perforations along flange ensure excellent finishing compound adhesion and flush finish. Moisture- and thermal-resistant properties make this ideal around bathtubs, showers, windows and skylights. Rustproof, dent-resistant, easy to cut and install.

Product code	Size	
	Width (in)	Length (ft)
VLMJ	1/2	8
		10
	5/8	8
		10



VINYL L-STOP BEAD



ClarkDietrich L-stop bead creates a clean detail at gypsum panel terminations into doors, windows and ceilings. Easily attaches with nails, screws or staples to studs through bead flange. Multiple perforations along 1-1/4" flange and raised shoulder enhance strong compound adhesion and provide for a flush finish. Rustproof, dent-resistant and easy to field cut without distorting profile or leaving sharp edges and burrs.

Product code	Size	
	Width (in)	Length (ft)
VLLS	1/2	8
		10
	5/8	8
		10

VINYL Rip Bead™ L-TRIM



ClarkDietrich Vinyl Rip Bead™ L-trim produces an exceptional finish at intersection of gypsum panels to ceiling grid, window returns and dissimilar wall types. A tear-away strip provides a protective edge and guide for drywall finishing knives. Once joint compound is applied, finished and painted, remove the tear-away strip to form a crisp, clean edge.

Product code	Size	
	Width (in)	Length (ft)
VLZL	1/2	8
		10
	5/8	8
		10

VINYL PARTITION END CAP FOR 1/2" OR 5/8" BOARD

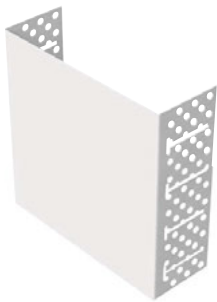

Vinyl partition end caps quickly finish doorways, knee walls and wall ends, providing a finished face. Designed with a special factory punched "T" slotted flange, they can be easily cut to form arches or curves. Instead of installing two corner beads, you install a single piece, using less compound. Easy to cut, rustproof and dent-resistant.

Product code	Size	
	Width (in)	Length (ft)
PEC50 (1/2")	2-1/2	10
	3-5/8	
PEC58 (5/8")	2-1/2	10
	3-5/8	

VINYL 093 DRYWALL CONTROL JOINT



Vinyl 093 control joint is applied between abutting gypsum panels to relieve stresses of expansion and contraction of drywall in large ceiling and wall expanses over 30'. Typically installed from door header to ceiling, from floor to ceiling in long partition runs, and from wall to wall in large ceiling areas. Remove plastic tape (protects 1/4" opening x 7/16" deep reveal) after compound is applied and finished.

Product code	Size	
	Width (in)	Length (ft)
VCJT	3/32	10

Note: Where sound transmission is a consideration, an approved seal must be provided behind the control joint.

BULLNOSE "J" BEAD

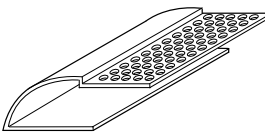

Vinyl Corp. bullnose "J" bead is designed to cover the raw edges of wallboard with a 3/4" radius bead. The perforated flange accepts joint compound or veneer plaster for a flush finish.

Product code	Board thickness (in)	Size	Pcs./Box
BJB50	1/2	1" perforated flanges, 3/4" back leg	50
BJB58	5/8		50

BULLNOSE "J" BEAD

Surface Application

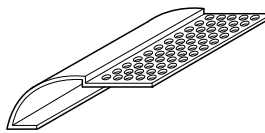

Vinyl Corp. bullnose "J" bead for surface application is designed to be applied after the wallboard is installed. Cover the raw edges of wallboard with a 3/4" radius bead. The perforated flange accepts joint compound or veneer plaster for a flush finish.

Product code	Board thickness (in)	Size	Pcs./Box
BJB50S	1/2	1" perforated flanges	50
BJB58S	5/8		50

METAL LATH AND ACCESSORIES

Durable beauty starts beneath the surface.

Whether using conventional or veneer plaster, having the right trims, control joints and corner reinforcements is an integral part of the wall system's appearance and long-term performance. ClarkDietrich's history in the manufacturing of metal lath and accessories gives us unique knowledge of this trade and the product quality it requires.

Metal lath and accessories create a strong mechanical bond with plaster, stucco and veneer, providing superior strength and reinforcement. Expanded mesh and rigid pronounced edges provide excellent keying and exacting grounds for superior bonding and finishing to minimize cracks and shadowing. Products can be readily shaped to enable ornamental contours not possible with other materials.

Applications include interior and exterior walls, ceilings, soffits, fascia and ceramic tile underlayment for both commercial and residential construction.

- Flat diamond mesh, self-furring dimpled and V-groove and high rib lath
- Wide selection of beads, screeds, joints and trim, in metal and vinyl
- Strength, flexibility, impact resistance
- Fire resistance: two hours for partitions, four hours for ceilings and columns
- Extremely difficult to penetrate, providing security against break-through

General notes/limitations: Metal lath products should not be used with magnesium oxychloride cement stuccos or stuccos containing calcium chloride additives. In ceiling assemblies, certain precautions concerning construction, insulation and ventilation are necessary for good performance.

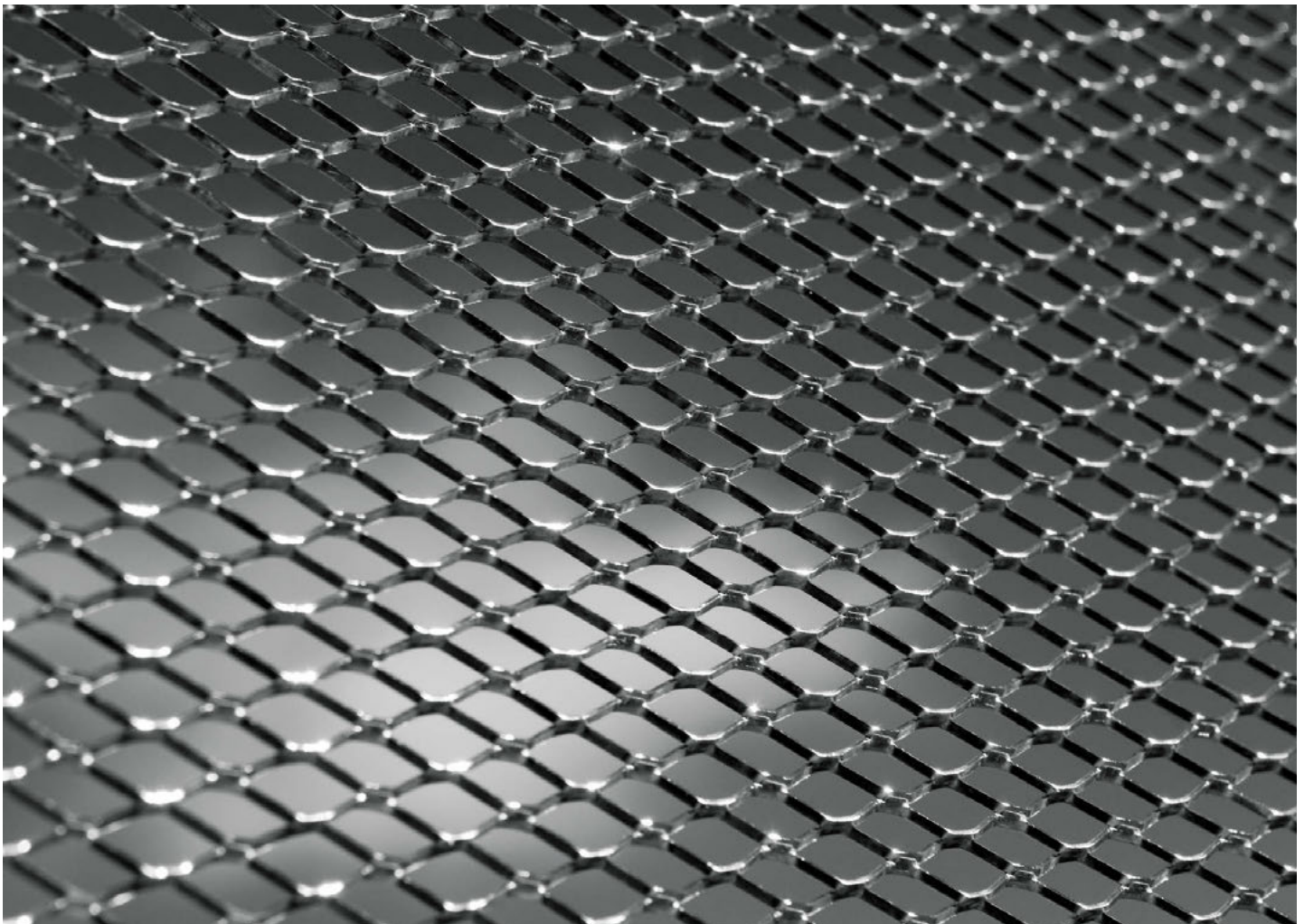

GALVANIZED Junior™ MESH LATH

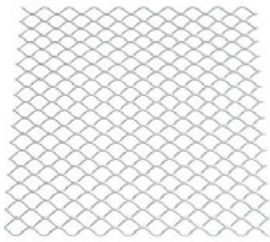

ClarkDietrich Junior™ diamond mesh lath is used as a substrate for gypsum plaster or for Portland cement plaster stucco on either interior or exterior walls, ceilings, soffit and fascia surfaces, and can be used under ceramic tile in wall, ceiling and floor applications. It's useful in all general-purpose applications and is the best lath available for ornamental work and contoured surfaces.

Product code	Weight (lbs/yard ²)	Size	
		Width (in)	Length (in)
LAM (O)	1.75	27	97
	2.5		
	3.4		

O = Paper is offset 1" on one long edge and end to ensure proper lath-to-lath laps and a minimum 2" paper overhang on the opposing long edge and end.

Note: Asphalt paper-backed lath is available in a variety of offsets for various applications requiring a moisture barrier. Paper conforms to Federal Specification UU-B-790A; type grade D, style 2 and type 1, grade B, style 1a.

SELF-FURRING DIMPLED LATH

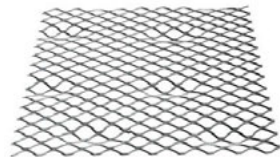

ClarkDietrich self-furring dimpled lath is manufactured with approximately 1/4" deep dimples that raise diamond mesh away from solid surfaces to enable thorough plaster or stucco penetration into and behind the lath for superior mechanical bonding. The dimples are spaced every 1-1/2" over the rectangular sheet, with approximately 11,000 keys per square yard. Fasteners must be applied within the dimple cavity, to maintain designed furring characteristics.

Product code	Weight (lbs/yard ²)	Size	
		Width (in)	Length (in)
LAD (O)	1.75	27	97
	2.5		
	3.4		

O = Paper is offset 1" on one long edge and end to ensure proper lath-to-lath laps and a minimum 2" paper overhang on the opposing long edge and end.

Note: Asphalt paper-backed lath is available for various applications requiring a moisture barrier.

SELF-FURRING V-GROOVE MESH LATH



ClarkDietrich self-furring v-groove mesh lath is manufactured with five, approximately 1/4" deep "V" ribs along the length of the sheet. The Vs allow thorough penetration into and behind the lath for superior mechanical bonding. Use over solid surfaces like concrete, cement board, column fireproofing, masonry, sheathing and to replaster over old surfaces.

Product code	Weight (lbs/yard ²)	Size	
		Width (in)	Length (in)
LAV (O)	1.75	27	97
	2.5		
	3.4		

O = Paper is offset 1" on one long edge and end to ensure proper lath-to-lath laps and a minimum 2" paper overhang on the opposing long edge and end.

Note: Asphalt paper-backed lath is available for various applications requiring a moisture barrier.

3/8" HIGH RIB LATH

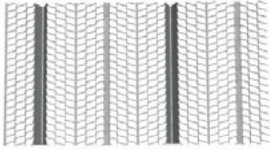

ClarkDietrich 3/8" high rib lath is the most rigid of all laths and provides the added support required when framing is more than 16" o.c. but does not exceed 24" o.c. Commonly used for soffits and ceilings under steel or wood joist construction and metal-reinforced concrete floors. 3/8" V-shaped ribs run the length of the sheet at 3-7/8" intervals and inverted 3/16" intermediate ribs.

Product code	Weight (lbs./yard ²)	Size	
		Width (in)	Length (in)
LAR	3.4	27	97

SPRAY RIB LATH



A more rigid lath than diamond mesh lath. Spray rib lath is the same 3/8" rib lath except it's made with strips of 50 lb. brown kraft paper backing, to help prevent loss of plaster over open framing or when machine-applied. Spray rib lath is not to be used as a replacement for Grade D breather sheet moisture-retardant paper.

Product code	Weight (lbs./yard ²)	Size	
		Width (in)	Length (in)
LARS	3.4	27	97

Available West Coast only.

UTILITY LATH

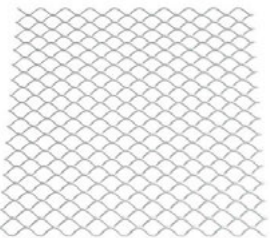

ClarkDietrich utility lath is a superior multipurpose expanded steel product widely used for ceramic tile and floor leveling, and for plaster and stucco repair and remodel. It is available in both the Junior™ mesh style as well as self-furring dimpled product. The self-furring product is manufactured with 1/4" deep dimples that raise the mesh away from solid surfaces for superior mechanical bonding.

Product code	Width (in)	Length (in)
LAMU – Junior Mesh (O)	27	97
LADU – Dimpled Self-Furring (O)	27	97

O = Paper is offset 1" on one long edge and end to ensure proper lath-to-lath laps and a minimum 2" paper overhang on the opposing long edge and end.

Note: Asphalt paper-backed lath is available for various applications requiring a moisture barrier.

BARRIER MESH

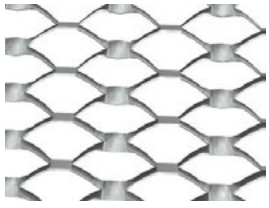

This tough, rigid heavy-gauge security mesh is used behind common-wall substrates to protect against break-ins and break-outs. Tough to smash or cut, it safeguards walls and ceilings in homes, apartments, offices, stores, vaults, storage areas and correctional facilities. Also fire-resistant, barrier mesh is a cost-effective, time-saving alternative to reinforced concrete or concrete block.

Product code	Thickness		Size (in)	SWD Width (in)	LWD Length (in)	C-C of bond (SWD x LWD)	Percent of open area
	Gauge	Overall thickness (in)					
BM50	18	.039	1/2	96	48	.500" x 1.20"	60
	16	.050				.500" x 1.20"	63
	13	.070				.500" x 1.20"	52
BM75	13	.070	3/4	96	48	.923" x 2.00"	74
	10	.120				.923" x 2.00"	63
BM10	16	.050	1	96	48	1.090" x 2.00"	78
BM15	16	.048	1-1/2	96	48	1.33" x 3.00"	83
	13	.070				1.33" x 3.00"	80
	10	.110				1.33" x 3.00"	75

- Product comes standard as carbon steel; galvanized is available upon request. Available in standard or flat.

STRIP LATH



ClarkDietrich strip lath is a flat expanded metal strip used as plaster reinforcement over joints of non-metallic lathing bases and where dissimilar bases join. It's commonly attached diagonally at the corners of doors, windows or areas prone to cracks. It may also be used to span pipe chases or reinforce other stress points such as the corners of openings in the stucco membrane within the lath system.

Product code	Size	
	Width (in)	Length (ft)
LAST	4	8
	6	

Cornerite™ METAL LATH ANGLE



Cornerite™ metal lath angle is used to reinforce all inside or inner plaster corners to reduce corner cracking. Formed from finished edge strip lath, it's bent lengthwise to a 100° angle to ensure a snug fit into 90° corners. It's commonly used when walls meet walls or ceilings, over inner angles of masonry construction, and in the floating-angle method of applying gypsum lath to wood framing.

Product code	Size	
	Width (in)	Length (ft)
XRIT	2 x 2	4
	2 x 2	8
	3 x 3	8

Structalath® II



For residential/wood frame construction, Structalath® II is a welded wire lath engineered to enhance the performance of stucco cladding. Structa Wire Corp's Structalath reduces cracking and increases stucco embedment while providing worker-friendly benefits.

Size		Area (sq yds)	Weight/Roll (lbs)	Packaging Rolls/Pallet
Width (in)	Length (ft)			
38-3/8	150	53	54	32
54	100	53	54	25
48	112.5	53	54	25

- Equivalent to 1.75 metal lath
- Not available in all geographic areas

Structalath® is a registered trademark of Structa Wire Corp.

Twin Trac®

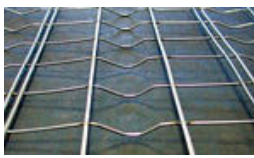

Structa Wire Corp's Twin Trac® is an innovative self-furring, reinforcing lath that simplifies the attachment of lath to wood and steel studs. Excellent for commercial construction, it has all the great features of regular Structalath plus eight secondary cold-rolled longitudinal wires that add strength to form a 'track' for convenient attachment. Also available in stainless steel.

Size		Area (sq yds)	Weight/Roll (lbs)	Packaging Rolls/Pallet
Width (in)	Length (ft)			
38-3/8	150	50	60	32

- Equivalent to 2.5 metal lath
- Not available in all geographic areas

Twin Trac® is a registered trademark of Structa Wire Corp.

Mega Lath™

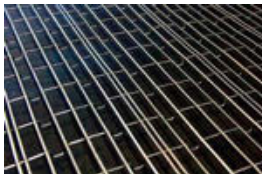

Structa Wire Corp's Mega Lath™ is self-furring, welded wire providing heavy-duty reinforcing for both stucco and stone installation. This product provides easy attachment for both wood and steel construction. It's specifically designed for stucco applications that require extra reinforcing.

Size		Area (sq yds)	Weight/Roll (lbs)	Packaging Rolls/Pallet
Width (in)	Length (ft)			
30	108	30	57	48

- Equivalent to 3.4 metal lath
- Not available in all geographic areas

Mega Lath™ is a trademark of Structa Wire Corp.

V Truss®



V Truss® for walls and ceilings was designed by Structa Wire Corp to improve the performance of stucco on overhead surfaces. This self-furring, welded wire lath is also approved for use on vertical surfaces and as a reinforcing component for rainscreen wall systems.

Size		Area (sq yds)	Weight/Sheet (lbs)	Packaging Sheets/Bundle
Width (in)	Length (in)			
28	98	2.1	4.5	12

- Equivalent to 3/8" high rib metal lath
 - Not available in all geographic areas
 - Also available with housewrap backing for open frame construction
- V Truss® is a registered trademark of Structa Wire Corp.

#1A EXPANDED FLANGE CORNER BEAD



ClarkDietrich 1A expanded flange corner bead is used to provide strong corner reinforcement for conventional plaster applications. A solid metal nose provides a straight, rigid ground for screeding, and the 2-7/8" or 3" flanges can be flexed easily over irregular, uneven surfaces. Plaster keys near the solid nose provide increased reinforcement where needed and ensure straight corners.

Product code	Size	
	Width (in)	Length (ft)
CBXA (galvanized)	2-7/8	8
		10
	3	8
CBZA* (zinc)	2-7/8	10
	3	

*Recommended for interior high-moisture exposure areas and exterior plaster applications.

Double-X™ CORNER BEAD



ClarkDietrich Double-X™ or 2A galvanized corner bead, provides additional rigidity for reinforcing plaster corners. Easily adjusts to set plaster depth on columns and is ideal for finishing corners of structural tile with rough masonry. Combination of expanded flanges and pronounced bead nose ensures effective corner alignment and efficient plaster keying from edge to nose.

Product code	Size	
	Width (in)	Length (ft)
CBXX	3-1/4	10

#66 EXPANDED FLANGE CASING BEAD

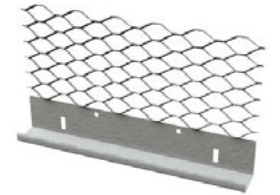

ClarkDietrich #66 expanded flange casing beads are used as a plaster stop, an exposed trim around wall openings, and at junctions or intersections of plaster and other wall or ceiling finishes. Extra-long expanded flange for tie-on applications. Short 90° return flange at plaster surface ensures a neat finish.

Commonly applied under metal lath. Also used with gypsum lath, plaster board, plaster bases, masonry construction or stucco applications.

Product code	Grounds (in)	Size	
		Length (ft)	Weep hole
XXCB (galvanized)	3/8	10	None
	1/2		
	5/8		
	3/4		
	7/8		
	1		
XXZB (zinc)	1-1/4	10	None
	3/8		
	1/2		
	5/8		
	3/4		
	7/8		
	1		
	1-1/4		

#66 EXPANDED FLANGE CASING BEAD WITH WEEP HOLE

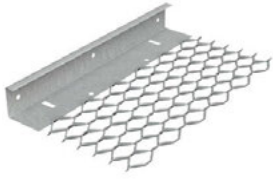

Designed for use with select, tested and approved one-coat plaster systems, this version of the #66 expanded flange casing bead includes weep holes for moisture dissipation. Expanded flange is 3-1/8" wide to aid plaster keying.

NOTE: It is important to remember that casing beads with weep holes punched in the ground flange are for tested and approved one-coat systems. No other applications are implied or suggested.

Product code	Size		
	Grounds (in)	Length (ft)	Weep hole
XXCW (galvanized)	3/8	10	Yes
	1/2		
	5/8		
	3/4		
	7/8		
	1		
XXZW (zinc)	1-1/4	10	Yes
	3/8		
	1/2		
	5/8		
	3/4		
	7/8		
	1		
	1-1/4		

#66 N SHORT FLANGE CASING BEAD



ClarkDietrich #66 N short flange casing beads are used as plaster stops, as exposed trim around wall openings and junctions, or at intersections of plaster and other wall or ceiling finishes. Perforated 1-1/4" nailing flange aids attachment and plaster keying. Short flange 7/8" beads are recommended when flange is applied *under* gypsum lath plaster base; and short flange 1/2" beads when flange is applied *over* gypsum lath plaster base.

Product code	Size		
	Grounds (in)	Length (ft)	Weep hole
SFCB (galvanized)	3/8	10	No
	1/2		
	5/8		
	3/4		
	7/8		
	1		
SFZB (zinc)	1-1/4	10	No
	3/8		
	1/2		
	3/4		
	7/8		

CAUTION: Suggestions for installation precautions when installing two-piece expansion joints and double casing beads used as double expansion joints—ASTM C1063 requires that double casing beads used as a movement joint are installed “with a flexible barrier membrane behind the casing beads.” It is ClarkDietrich’s opinion that all two-piece joints, whether made from double casing beads or as a manufactured two-piece joint, should be installed with the flexible peel and stick membrane behind the joint. It is further recommended that they be filled with backer rod and a highly elastic top-quality sealant.

#66 N SHORT FLANGE CASING BEAD WITH WEEP HOLE



This #66 N short flange galvanized casing bead has the same uses as the #66 expanded flange casing beads associated with select one-coat systems, but it has weep holes for moisture dissipation. Perforated 1-1/4" nailing flange aids attachment and plaster keying.

NOTE: It is important to remember that casing beads with weep holes punched in the ground flange are for tested and approved one-coat systems. No other applications are implied or suggested.

Product code	Size		
	Grounds (in)	Length (ft)	Weep hole
SFWB*	3/8	10	Yes
	1/2		
	5/8		
	3/4		
	7/8		
	1		
	1-1/4		

*Available in zinc as a custom order.

DOUBLE-V CONTROL JOINT



Double-V expansion control joints relieve the stresses of basic expansion and contraction associated with inherent shrinkage during stucco curing and general thermal changes. Resists corrosion, plus expanded flanges allow for proper keying and easy installation. Ground heights include 3/8" for thin coat plaster and 1/2," 3/4" and 7/8" for conventional plaster.

Product code	Size	
	Grounds (in)	Length (ft)
VVCJ (galvanized)	3/8	10
	1/2	
	3/4	
	7/8	
VVJZ (zinc)	1/2	10
	3/4	
	7/8	

DOUBLE-J CONTROL JOINT



A general-purpose control joint offering exceptional expansion control for plastered walls and ceilings, the double-J expansion control joint has a 5/16" reveal and rolled outer edges that allow effective plaster bonding. This helps prevent visible separation cracks. Plastic tape keeps the reveal clean and is removed easily after finish application.

Product code	Size	
	Grounds (in)	Length (ft)
XJ15 (galvanized)	1/2	10
	3/4	
	7/8	
ZJ15 (zinc)	1/2	10
	3/4	
	7/8	

Corner Master™ #30 CONTRACTION CONTROL JOINT



ClarkDietrich Corner Master™ #30 expansion/contraction control joint is designed to provide stress relief at plaster wall inside corner intersections, by absorbing movement and controlling cracking. It has expanded flanges pre-formed at 90° for a flush fit at inside corners. Ground heights offered aid plaster keying and result in a clean, straight finish. Manufactured from galvanized steel for corrosion protection.

Product code	Size	
	Grounds (in)	Length (ft)
CR30	1/2	10
	3/4	
	7/8	

CAUTION: Joints and corners are a potential point of water intrusion. ClarkDietrich strongly recommends building paper be placed as flashing behind all joints and corners. Also, a bead of high-quality caulking should be applied under the joints prior to the attachment of the materials.

EXPANSION JOINT #40



ClarkDietrich expansion joint #40 is a two-piece slip joint that finishes butt ends of adjacent panels in wide or tall walls and ceilings, to allow for multi-directional movement. Ideal for joining dissimilar wall types such as wood framing to CMU and at construction joints. Use where excessive horizontal and vertical movement may occur. Adjustable expansion opening or reveal is 1/4" to 5/8".

Product code	Size	
	Grounds (in)	Length (ft)
EJ40 (galvanized)	1/2	10
	3/4	
	7/8	
EZ40 (zinc)	1/2	10
	3/4	
	7/8	

CAUTION: Suggestions for installation precautions when installing two-piece expansion joints and double casing beads used as double expansion joints—ASTM C1063 requires that double casing beads used as a movement joint are installed “with a flexible barrier membrane behind the casing beads.” It is ClarkDietrich’s opinion that all two-piece joints, whether made from double casing beads or as a manufactured two-piece joint, should be installed with the flexible peel and stick membrane behind the joint. It is further recommended that they be filled with backer rod and a highly elastic top-quality sealant.

093 ZINC CONTROL JOINT



ClarkDietrich 093 zinc control joint is applied between abutting gypsum panels to relieve stresses of expansion and contraction of drywall and veneer plaster systems in wall expanses over 30', and ceiling areas exceeding 2,500 square feet. It's installed from door header to ceiling, from floor to ceiling in long partition runs, and from wall to wall in large ceiling areas or in areas where framing or furring change direction. For interior or exterior applications.

Product code	Size	
	Grounds (in)	Length (ft)
ZNCJ	3/32	10

NOTE: Where fire and sound control are prime considerations, an approved seal must be installed behind the control joint.

ZINC CONTROL JOINTS 38, 50, 75 AND 100



Zinc control joints 38, 50, 75 and 100 are roll-formed from zinc to resist corrosion in both interior and exterior applications with gypsum or Portland cement plaster. An open slot, 1/4" wide and 1/2" deep, is protected with plastic tape that is removed after plaster and finish are completed. Perforated short flanges aid keying and wire attachment to metal lath or stapling to gypsum lath.

Product code	Size	
	Grounds (in)	Length (ft)
ZCJ3	3/8	10
ZCJ5	1/2	
ZCJ7	3/4	
ZCJ1	1	

CAUTION: Joints and corners are a potential point of water intrusion. ClarkDietrich strongly recommends building paper be placed as flashing behind all joints and corners. Also, a bead of high-quality caulking should be applied under the joints prior to the attachment of the materials.

F.H.A.7 FOUNDATION WEEP SCREED



F.H.A.7 foundation weep screed protects the stop edges of stucco and exterior insulated finish system materials at the sill plate. Commonly referred to as F.H.A. screed, it meets all pertinent F.H.A. requirements as part of a drainage system for exterior stucco applications. Meets IBC requirement for foundation screeds.

Product code	Size		
	Grounds (in)	Depth (in)	Length (ft)
FHA7	7/8	3-1/2	10
	1-3/8	3-1/2	10

Also available without bonding holes and in 28 gauge (FHAE) for non-code work.

7/8" SILL SCREED



7/8" sill screed is a similar profile to the F.H.A.7 foundation weep screed except the bottom flange has been cut back to allow trowel access for cleaning excess material and trimming of the vapor barrier. It offers impact and splash protection, and meets all other applicable codes with respect to 3-1/2" nailing flange, 26 gauge galvanized steel and 7/8" ground.

Product code	Size		
	Grounds (in)	Depth (in)	Length (ft)
SI36	7/8	5-1/2	10

1-3/8" J-WEEP WITH 2" NAILING FLANGE AND WEEP HOLE



ClarkDietrich 1-3/8" J-weep low-back is commonly used as a stop around door and window openings or in areas where stucco or E.I.F.S. terminations abut dissimilar wall types. Nail, screw or staple-attach to the frame or sheathing, then foam insulation, cement board or metal lath can be installed over it. The protruding ridge of the metal must extend beyond the plane of overlaid materials.

Product code	Size			Weep hole
	Grounds (in)	Depth (in)	Length (ft)	
JCLB	1-3/8	2	10	No
JWLB	1-3/8	2	10	Yes

NOTE: Do not use as a foundation weep screed for three-coat stucco applications. It should only be used on approved one-coat systems. Does **not** conform to code-required work if used as a foundation weep.

3-1/2" J-WEEP HIGH-BACK PLASTER STOP



J-weep high-back plaster stop is a J-shaped square-nosed trim manufactured from 26 gauge galvanized steel. Punched weep holes allow for use as a sill weep screed or screed and trim around wall openings. Squared bends accommodate 1" rigid insulation and 3/8" one-coat stucco applications. Meets the IBC requirements for foundation weep screeds.

Product code	Size			Weep hole
	Grounds (in)	Depth (in)	Length (ft)	
JWP	7/8	3-1/2	10	Yes
	1-3/8	3-1/2	10	

CAUTION: Joints and corners are a potential point of water intrusion. ClarkDietrich strongly recommends building paper be placed as flashing behind all joints and corners. Also, a bead of high-quality caulking should be applied under the joints prior to the attachment of the materials.

Mini-Bead™ 800 AND 900



ClarkDietrich Mini-Bead™ 800 and 900 are fine-mesh corner beads used to provide corner reinforcement for one- and two-coat veneer plaster systems. Mini-Bead 800 has 1/16" grounds for one-coat veneer plaster and 90 keys per linear foot for excellent bonding and strong corners. Mini-Bead 900 has 3/32" grounds for two-coat veneer plaster systems.

Product code	Grounds (in)	Size	
		Width (in)	Length (ft)
MB80 (galvanized)	1/16	1-1/4	8
MB90 (galvanized)	3/32	1-1/4	10
ZB80 (zinc)	1/16	1-1/4	10
ZB90 (zinc)	3/32	1-1/4	10

Note: Zinc Mini-Beads should be used in exterior finish systems.

#701A METAL J-TRIM WITH 3/32" AND 1/16" GROUNDS



ClarkDietrich veneer trims are J-shaped to fit standard gypsum panel depths with grounds to accommodate veneer finishes. They provide clean, neat edge protection for one- or two-coat veneer plaster finishes at gypsum panel terminations to wall openings and wall or ceiling intersections. Trim with 3/32" grounds is for two-coat veneers and trim with 1/16" grounds is for one-coat veneer plaster.

Our zinc alternatives provide ultimate corrosion protection for cement board and exterior applications.

Product code	Grounds (in)	Size	
		Width (in)	Length (ft)
M71A (galvanized)	3/32	1/2	8
			10
		5/8	8
M81A (galvanized)	1/16	1/2	10
			8
		5/8	10
Z71A (zinc)	3/32	1/2	10
		5/8	10
Z81A (zinc)	1/16	1/2	10
		5/8	10

#701B METAL L-TRIM WITH 3/32" AND 1/16" GROUNDS



Our veneer trims are L-shaped trims designed for use at junctions of veneer gypsum base with rough concrete or masonry ceilings. Sized to fit standard gypsum plaster bases, the trim with 3/32" grounds is for two-coat veneer, and the trim with 1/16" grounds is for one-coat veneer plaster.

Our zinc alternatives provide the added benefit of ultimate corrosion protection for exterior applications.

Product code	Grounds (in)	Size	
		Width (in)	Length (ft)
M71B (galvanized)	3/32	1/2	8
			10
		5/8	8
M81B (galvanized)	1/16	1/2	10
			8
		5/8	10
Z71B (zinc)	3/32	1/2	10
		5/8	10
Z81B (zinc)	1/16	1/2	10
		5/8	10

#4 SHORT FLANGE CORNER BEAD



For use on straight corners, or one flange can be snapped then bent without kinking. For use on arched radius.

Product code	Length (ft)
#4	8
#4	10

Available West Coast only.

WIRE CORNER REINFORCEMENT



A welded wire right angle assembly, affording a truer, stronger exterior corner that reduces cracking in Portland cement plaster.

Bullnose, Stockaid and Archaid are also available in stock 10' lengths.

Product code	Size	
	Flange (in)	Length (ft)
W951	2-1/2 x 2-1/2	10

Available West Coast only.

TILE CAP



Preferred method where sink or lavatory is to be recessed. A punched metal strip attached to the front edge of the cabinet is used in some geographical areas as a screed and support for the countertop trim.

Product code	Length (ft)
TC127	5
TZ154	5



VINYL CORNER BEAD

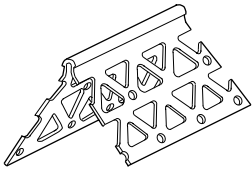

Vinyl Corp. #1 corner bead provides hard-to-damage, rustproof, straight corners, and is easily curved for smooth arches. A heavier version of our #1 corner bead, the #2 corner bead also has wider flanges. #2 corner beads should be used where a more durable corner is required.

Product code	Length (ft)	Ground	Size (in)	Pcs./Box
#1	7, 8, 9, 10	Any	2-1/2 X 2-1/2	50
#2	8, 10	Any	2-3/4 X 2-3/4	40

JUMBO CORNER BEAD

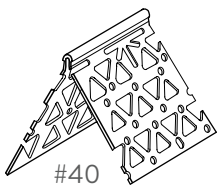

#40

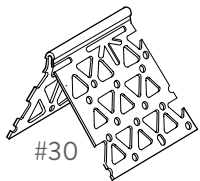

#30

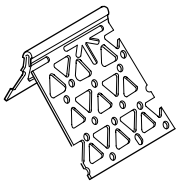

#4150

Vinyl Corp. jumbo corner bead is designed for deep fills or irregular corner conditions.

Product code	Ground	Size (in)	Pcs./Box
#40	Any	4-1/4 x 4-1/4	25
#30	Any	3 x 3	25
#43	Any	4-1/4 x 3	25
#4150	Any	4-1/4 x 1-1/2	25
#3150	Any	3 x 1-1/2	25

U.S. Patent Nos. 5,816,002 and 6,070,374

VINYL Archmaker™ CORNER BEAD

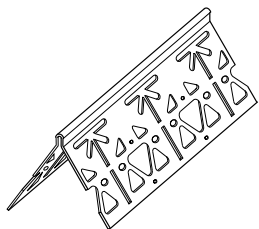

Our #1 Archmaker™ corner bead provides true, uniform, curved or arched reinforcement. The heavier version of our #1 Arch, our #2 Arch corner bead should be used for applications requiring increased damage resistance. The #1X Archmaker corner bead provides a true, uniform, curved or arched reinforcement with a 1-1/2" flange for narrow returns. The #2X Arch is a heavier version of our #1X Arch and should be used for increased damage resistance. All of our Archmaker corner beads conform to most arched and curved designs.

Product code	Ground	Size (in)	Pcs./Box
#1Arch	Any	2-1/2 x 2-1/2	50
#2Arch	Any	2-3/4 x 2-3/4	40
#1XArch	Any	2-1/2 x 1-1/2	50
#2XArch	Any	2-3/4 x 1-1/2	40

U.S. Patent Nos. 5,816,002 and 6,070,374



VINYL BULLNOSE CORNER BEAD

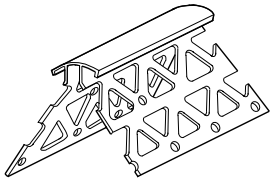

Designed for use in applications such as schools and hospitals, Vinyl Corp.'s #1B 3/4" bullnose corner bead provides hard-to-damage, rustproof, soft corners. The #2B bullnose corner bead is a heavier version that is appropriate for applications where a more durable corner is required.

Product code	Length (ft)	Ground	Size (in)	Pcs./Box
#1B	7, 8, 9, 10	Any	2-1/2 x 2-1/2	20
#2B	8, 10	Any	2-3/4 x 2-3/4	16

VINYL BULLNOSE Archmaker™ CORNER BEAD

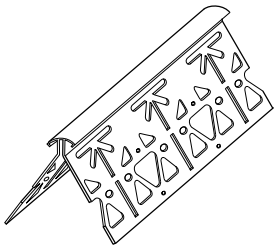

#1 bullnose Archmaker™ corner beads offer a true, uniform, curved or arched corner reinforcement with a bullnose design. The #2B bullnose Archmaker corner bead provides a heavier option for use where a more durable corner is desired. Both conform to most arched and curved designs.

Product code	Length (ft)	Ground	Size (in)	Pcs./Box
#1BArch	7, 8, 9, 10	Any	2-1/2 x 2-1/2	20
#2BArch	8, 10	Any	2-3/4 x 2-3/4	16

U.S. Patent Nos. 5,816,002 and 6,070,374

VINYL CASING BEAD/PLASTER STOP

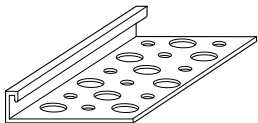

Vinyl Corp. casing beads and plaster stops are used to terminate stucco and plaster against doors, windows and dissimilar materials.

Product code	Ground (in)	Size (in)	Pcs./Box
6625	1/4	1-3/4 flange width	100
6638	3/8		100
6650	1/2		100
6658	5/8		100
6675	3/4		75
6678	7/8		75
66100	1		75

VINYL CONTROL JOINT

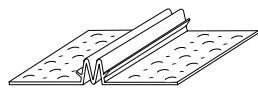

Control joints are designed to relieve stress and assist in controlling cracking in large areas of walls and ceilings. Vinyl Corp.'s specially designed Connector Clips are provided for alignment and base for sealants.

Product code	Ground (in)	Size (in)	Pcs./Box
1538	3/8	4 flange width	35
1550	1/2		35
1558	5/8		30
1575	3/4		26
1578	7/8		20
15100	1		20

NOTE: Connector Clips are not provided with 3/8" ground. Positive attachment of each flange or control joint to separate framing is required. Caulk all intersections, butt joints, ends and corners at time of installation.

METAL LATH & ACCESSORIES

VINYL CONTROL JOINT

With removable tape

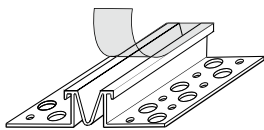

Used to provide stress relief and assist in controlling cracking in large areas of walls and ceilings, control joints with removable tape protect the deep “V” expansion slot during construction. Specially designed Connector Clips are provided for alignment and base for sealants. Recommended for smooth finishes.

Product code	Ground (in)	Size (in)	Pcs./Box
1525X	1/4	2-1/4 flange width	50
1538X	3/8	3-1/4 flange width	50
1550X	1/2		40
1558X	5/8		35
1575X	3/4		30
1578X	7/8		30
15100X	1		30

NOTE: Connector Clips are not provided for 1/4" or 3/8" grounds. Positive attachment of each flange of control joint to separate framing is required. Caulk all intersections, butt joints, ends and corners at time of installation.

VINYL 3-1/2" WEEP SCREED

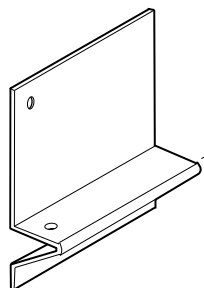

Vinyl Corp. 3-1/2" weep screed is designed to relieve moisture from stucco and act as a stop. It should be installed on frame construction where stucco and foundation walls meet.

Product number	Ground (in)	Size (in)	Pcs./Box
WS38-350U	3/8	4 overall width	50
WS50-350U	1/2		50
WS58-350U	5/8		40
WS75-350U	3/4		40
WS78-350U	7/8		30
WS138-350U	1-3/8		30

Caulk all intersections, butt joints, ends and corners at time of installation.

VINYL FOUNDATION WEEP SCREED

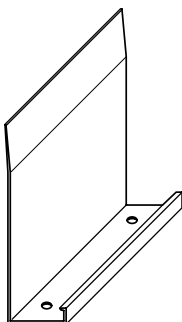

Foundation weep screed acts as a stop, and is designed with an unperforated flange, allowing moisture removal from stucco installations on frame construction at the foundation line.

Product code	Ground (in)	Size (in)	Pcs./Box
FWS6678W	7/8	3-1/2 overall width	40
FWS66138W	1-3/8		40

Caulk all intersections, butt joints, ends and corners at time of installation.

CLIPS AND CONNECTORS

Any clip or connector you'd need, exactly when you want it. Strength is in the details.

For the widest and most cost-effective array of clips, connectors, supports and framing hardware, turn to ClarkDietrich Clip Express.SM With Clip Express, you get fully engineered, rigorously tested and precision-formed connectors each and every time. Many of our connectors were developed by, or in conjunction with, framing installers in order to deliver high-performance products for significant installed savings.

But what makes Clip Express unique is not simply the vast lineup of products. It's our delivery, and pronto. Because we know that staying on schedule is crucial, we ship most orders the same day they are received.

We know that having the right products, at the right time, and at the right price is absolutely essential to getting the job done. ClarkDietrich Clip Express is ready to deliver. When, how and where you need it.

- Curtain wall/bypass connections
- Head-of-wall, deflection and rigid connections
- Floor joist, roof and truss framing connections
- Bridging, bracing and backing connections
- Gusset plates, specialty clips, connectors and fasteners
- Overnight delivery available



FastClip™ SLIDE CLIP



FastClip Slide Clip (3-1/2")

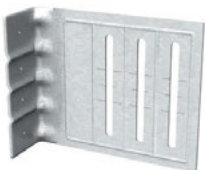

FastClip Slide Clip (5-1/2")

ClarkDietrich FastClip™ slide clip deflection clips are used to attach exterior curtain wall studs to the building structure and provide for vertical building movement independent of the cold-formed steel framing. FastClip slide clips install quickly with screws or powder-actuated fasteners. Embossed with fastening patterns to ensure accurate placement.

Product code	Thickness			Size (in)	Packaging Pcs./Carton
	Gauge	Mils	Design thickness (in)		
FCSC	14	68	0.0713	1-1/2 x 3-1/2 x 4-1/2	25
FCSC	14	68	0.0713	1-1/2 x 5-1/2 x 4-1/2	

3-1/2" FCSC includes 55 FastClip deflection screws per carton.
 5-1/2" FCSC includes 80 FastClip deflection screws per carton.
 U.S. Patent No. 6,688,069

Fast Strut™



Fast Strut 12



Fast Strut 15

The ClarkDietrich Fast Strut™ curtain wall connector employs the FastClip technology for curtain wall stud attachment and is commonly used when large standoff conditions exist. FastStrut products allow framing attachment well beyond the perimeter of the structural steel—or when the spandrel beams are set back from the edge of the structure. Attached to the underside of structural members with screws, welds or powder-actuated fasteners.

Product code	Thickness			Size (in)	Packaging Pcs./Carton
	Gauge	Mils	Design thickness (in)		
FS12	14	68	0.0713	4 x 2 x 12-1/4	10
FS15	14	68	0.0713	4 x 2 x 15-1/4	
Custom lengths	14	68	0.0713	per customer specs	

Includes 55 FastClip deflection screws per carton.
 U.S. Patent No. 6,688,069

FastHook FastClip™ SLIDE CLIP



Left-hand version shown

Revolutionary FastHook technology allows the installer to temporarily hang clip in place on pour stop or perimeter angle, freeing both hands for the installation of permanent fasteners. Used to attach exterior curtain wall studs to the building structure, they provide for up to 3" of vertical building movement independent of the cold-formed steel framing.

Product code	Thickness			Size (in)	Packaging Pcs./Bucket
	Gauge	Mils	Design thickness (in)		
FHCL	14	68	0.0713	1-1/2 x 5-1/2 x 4-1/2	25
FHCR	14	68	0.0713	1-1/2 x 5-1/2 x 4-1/2	25

FHCL = FastHook FastClip, left
 FHCR = FastHook FastClip, right
 Please specify when ordering.
 Includes 80 FastClip deflection screws per bucket.

Flat Tail Slide Clip™

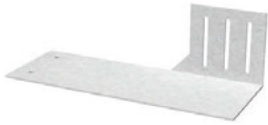

ClarkDietrich's Flat Tail Slide Clip™ is used to attach exterior curtain wall studs to the building structure, providing for 2-1/4" vertical building movement independent of the cold-formed steel framing. It provides variable standoff, eliminating the need for shims or additional framing components. Restricts lateral movement, but enables the curtain wall system to move vertically.

Product code	Thickness			Stud width (in)	Packaging Pcs./Bucket
	Gauge	Mils	Design thickness (in)		
FTSC	10	118	0.1242	3-5/8-8	25

Includes 80 FastClip deflection screws per bucket.

QuickClip™

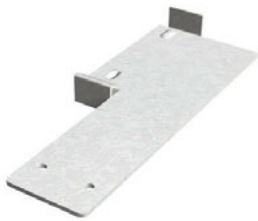

QuickClip™ vertical slide clips attach exterior curtain wall studs to the building structure and provide for vertical building movement independent of the cold-formed steel framing. Provide variable standoff and eliminate the need for shims or additional framing components. Simply rotate into place and fasten to the floor/ceiling beam. The clips restrict lateral movement, but enable the structure to move vertically.

Product code	Thickness			Stud width (in)	Packaging Pcs./Bucket
	Gauge	Mils	Design thickness (in)		
QC3	10	118	0.1242	3-5/8	50
QC4	10	118	0.1242	4	50
QC6	10	118	0.1242	6	50
QC8	10	118	0.1242	8	40

U.S. Patent No. 5,836,133 of B&D Industries, Inc.

Slide Clip™



A ClarkDietrich Slide Clip™ is used to attach exterior curtain wall studs to the building structure and provide for vertical building movement independent of the cold-formed steel framing. Slide clips are used in bypass framing situations and are normally welded or otherwise fastened to the vertical leg of a structural angle at the floor or roof edge.

Product code	Thickness			Size (in)	Packaging Pcs./Carton
	Gauge	Mils	Design thickness (in)		
SD	14	68	0.0713	2-3/8 x 5	50
SD	12	97	0.1017	2-3/8 x 5	

CLIPS AND CONNECTORS

Fast Top™ CLIP



FTC3



FTC5

ClarkDietrich Fast Top™ clips are used in head-of-wall deflection conditions for in-fill curtain wall assemblies to provide for vertical movement. Use in place of, or in combination with, deflection track. They also make a positive attachment and eliminate the need to install bridging continuously throughout the upper-most punchouts.

Product code	Thickness			Web width (in)	Leg length (in)	Standard length (ft)	Packaging Pcs./Carton
	Gauge	Mils	Design thickness (in)				
FTC3	14	68	0.0713	4	1-1/2	3-1/4	25
FTC5	14	68	0.0713	4	1-1/2	4-3/4	30

FTC3 includes 55 FastClip™ deflection screws per carton.
 FTC5 includes 110 FastClip deflection screws per carton.
 U.S. Patent No. 6,688,069

Uni-Clip™ END CLIP



ClarkDietrich's Uni-Clip™ end clip is a universal framing clip used to attach and support numerous rigid framing conditions. The Uni-Clip framing clip has a stiffened corner that provides superior design values and is installed easily with screws or powder-actuated fasteners. This clip is ideal for most rigid connections, including shear, tension and two-axis loading.

Product code	Thickness			Size (in)	Packaging Pcs./Carton
	Gauge	Mils	Design thickness (in)		
UCEC	14	68	0.0713	3-1/2 x 1-1/2 x 4-1/2	25

U.S. Patent No. 6,688,069

EasyClip™ E-Series™ SUPPORT CLIP



ClarkDietrich EasyClip™ E-Series™ support clips are used for rigid standoff connections. The 4" wide leg provides extra length to achieve standoff connections up to 3". These support clips are commonly used in bypass wall conditions, solid blocking attachments in joist framing, and to secure rafter framing to the primary structure. EasyClip E-Series support clips are prepunched for faster and more accurate fastener placement.

Product code	Thickness			Size (in)	Packaging Pcs./Bucket
	Gauge	Mils	Design thickness (in)		
E543	16	54	0.0566	4 x 1-1/2 x 3	100
E545				4 x 1-1/2 x 5	100
E547				4 x 1-1/2 x 7	100
E549				4 x 1-1/2 x 9	50
E541				4 x 1-1/2 x 11	50
E683	14	68	0.0713	4 x 1-1/2 x 3	100
E685				4 x 1-1/2 x 5	100
E687				4 x 1-1/2 x 7	80
E689				4 x 1-1/2 x 9	50
E681				4 x 1-1/2 x 11	50
E973	12	97	0.1017	4 x 1-1/2 x 3	50
E975				4 x 1-1/2 x 5	50
E977				4 x 1-1/2 x 7	50
E979				4 x 1-1/2 x 9	50
E971				4 x 1-1/2 x 11	40

EasyClip S-Series™ SUPPORT CLIP

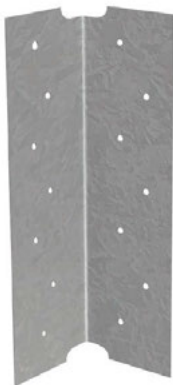

ClarkDietrich EasyClip S-Series™ support clips are used for rigid connections in window and door framing, joist, bypass or other miscellaneous connections to secure one framing member to another—or to secure framing members to the structural frame. EasyClip S-Series clips are prepunched for faster and more accurate fastener placement.

Product code	Thickness			Size (in)	Packaging Pcs./Bucket
	Gauge	Mils	Design thickness (in)		
S543	16	54	0.0566	1-1/2 x 1-1/2 x 3	400
S545				1-1/2 x 1-1/2 x 5	200
S547				1-1/2 x 1-1/2 x 7	100
S549				1-1/2 x 1-1/2 x 9	100
S541				1-1/2 x 1-1/2 x 11	100
S683	14	68	0.0713	1-1/2 x 1-1/2 x 3	200
S685				1-1/2 x 1-1/2 x 5	200
S687				1-1/2 x 1-1/2 x 7	100
S689				1-1/2 x 1-1/2 x 9	100
S681				1-1/2 x 1-1/2 x 11	100
S973	12	97	0.1017	1-1/2 x 1-1/2 x 3	200
S975				1-1/2 x 1-1/2 x 5	150
S977				1-1/2 x 1-1/2 x 7	100
S979				1-1/2 x 1-1/2 x 9	80
S971				1-1/2 x 1-1/2 x 11	70

CLIPS AND CONNECTORS

EasyClip™ U-Series™ CLIP ANGLE



ClarkDietrich EasyClip™ U-Series™ clip angles are used to secure U-channel to wall studs for lateral bridging or for miscellaneous rigid connections. U-channel is passed through the stud knockout and an EasyClip U-Series clip is screw-attached or welded to provide a rigid connection. These clips are prepunched for faster, more accurate fastener placement. Do not use in bridging applications when the stud width exceeds 6."

Product code	Thickness			Size (in)	Packaging Pcs./Bucket
	Gauge	Mils	Design thickness (in)		
U543	16	54	0.0566	1-1/2 x 1-1/2 x 3-3/8	400
U545				1-1/2 x 1-1/2 x 5-3/4	200
U547				1-1/2 x 1-1/2 x 7-3/4	100
U549				1-1/2 x 1-1/2 x 9-3/4	100
U683	14	68	0.0713	1-1/2 x 1-1/2 x 3-3/8	200
U685				1-1/2 x 1-1/2 x 5-3/4	170
U687				1-1/2 x 1-1/2 x 7-3/4	100
U689				1-1/2 x 1-1/2 x 9-3/4	100
U973	12	97	0.1017	1-1/2 x 1-1/2 x 3-3/8	200
U975				1-1/2 x 1-1/2 x 5-3/4	130
U977				1-1/2 x 1-1/2 x 7-3/4	100
U979				1-1/2 x 1-1/2 x 9-3/4	80

EasyClip B-Series™ CLIP ANGLE



ClarkDietrich EasyClip B-Series™ clip angles are used to secure U-channel to wall studs in back-to-back framing applications and for various miscellaneous rigid connections. The shorter length of the B-Series clip enables it to be installed inside the C-shape. It can also be used to secure lateral bridging on single studs where the clip is preferred to be inside the C-shape. Do not use in lateral bridging when stud width exceeds 6."

Product code	Thickness			Size (in)	Packaging Pcs./Bucket
	Gauge	Mils	Design thickness (in)		
B543	16	54	0.0566	1-1/2 x 1-1/2 x 3	400
B545				1-1/2 x 1-1/2 x 5-1/4	200
B547				1-1/2 x 1-1/2 x 7-1/4	100
B549				1-1/2 x 1-1/2 x 9-1/4	100
B683	14	68	0.0713	1-1/2 x 1-1/2 x 3	200
B685				1-1/2 x 1-1/2 x 5-1/4	170
B687				1-1/2 x 1-1/2 x 7-1/4	100
B689				1-1/2 x 1-1/2 x 9-1/4	100
B973	12	97	0.1017	1-1/2 x 1-1/2 x 3	200
B975				1-1/2 x 1-1/2 x 5-1/4	130
B977				1-1/2 x 1-1/2 x 7-1/4	100
B979				1-1/2 x 1-1/2 x 9-1/4	80

EasyClip X-Series™ CLIP ANGLE



ClarkDietrich EasyClip X-Series™ clip angles are used to secure U-channel to wall studs for lateral bridging. U-channel is passed through the stud knockout and an EasyClip X-Series clip is screw-attached or welded to provide a rigid connection. X-Series clip angles and U-channel should not be used in lateral bridging when stud width exceeds 6."

Product code	Thickness			Size (in)	Packaging Pcs./Bucket
	Gauge	Mils	Design thickness (in)		
X543	16	54	0.0566	2 x 2 x 3-3/8	200
X545				2 x 2 x 5-3/4	170
X547				2 x 2 x 7-3/4	100
X549				2 x 2 x 9-3/4	100
X683	14	68	0.0713	2 x 2 x 3-3/8	200
X685				2 x 2 x 5-3/4	100
X687				2 x 2 x 7-3/4	100
X689				2 x 2 x 9-3/4	80
X973	12	97	0.1017	2 x 2 x 3-3/8	100
X975				2 x 2 x 5-3/4	100
X977				2 x 2 x 7-3/4	60
X979				2 x 2 x 9-3/4	60

SwiftClip™ LS-Series™ SUPPORT CLIP



SwiftClip™ LS-Series™ support clips are used in multiple construction projects, specifically in conjunction with studs and track. The L-shaped clips fit between the stud flanges, so that shorter length clips do not need to be ordered. These labor time-savers include prepunched holes for quicker screw attachments, and are punched to accommodate for U-channel lateral bracing connections.

Product code	Thickness			Size (in)	Packaging Pcs./Bucket
	Gauge	Mils	Design thickness (in)		
LS543	16	54	0.0566	1-1/2 x 1-1/2 x 3-1/4	300
LS545				1-1/2 x 1-1/2 x 5-1/2	200
LS547				1-1/2 x 1-1/2 x 7-1/4	150
LS549				1-1/2 x 1-1/2 x 9-1/4	100
LS541				1-1/2 x 1-1/2 x 11-1/4	100
LS683	14	68	0.0713	1-1/2 x 1-1/2 x 3-1/4	300
LS685				1-1/2 x 1-1/2 x 5-1/2	200
LS687				1-1/2 x 1-1/2 x 7-1/4	100
LS689				1-1/2 x 1-1/2 x 9-1/4	100
LS681				1-1/2 x 1-1/2 x 11-1/4	50
LS973	12	97	0.1017	1-1/2 x 1-1/2 x 3-1/4	200
LS975				1-1/2 x 1-1/2 x 5-1/2	100
LS977				1-1/2 x 1-1/2 x 7-1/4	100
LS979				1-1/2 x 1-1/2 x 9-1/4	50
LS971				1-1/2 x 1-1/2 x 11-1/4	50

EasyClip™ A-Series™ END CLIP



ClarkDietrich EasyClip™ A-Series™ end clips are most commonly used to reinforce connections in knee-wall applications or to reinforce jamb stud connections to the primary frame. These clips are unpunched, as the specific application will determine the appropriate number and placement of fasteners.

Product code	Thickness			Size (in)	Packaging Pcs./Bucket
	Gauge	Mils	Design thickness (in)		
A543	16	54	0.0566	3 x 3 x 3	100
A546				3 x 3 x 6	100
A683	14	68	0.0713	3 x 3 x 3	100
A686				3 x 3 x 6	100
A973	12	97	0.1017	3 x 3 x 3	100
A976				3 x 3 x 6	50

EasyClip D-Series™ ANCHOR CLIP



ClarkDietrich EasyClip D-Series™ anchor clips are high-performance, cost-effective solutions for knee wall-to-foundation connections, light-duty shearwall-to-foundation connections and truss-to-wall connections. These multi-application clips feature reinforced stiffening ribs that provide superior design values for maximum performance.

Product code	Thickness			Size (in)	Packaging Pcs./Bucket
	Gauge	Mils	Design thickness (in)		
D683	14	68	0.0713	2 x 2 x 3-1/2	40
D685				2 x 2 x 5-1/2	
D973	12	97	0.1017	2 x 2 x 3-1/2	
D975				2 x 2 x 5-1/2	

EasyClip™ T-Series™ TALL ANCHOR CLIP

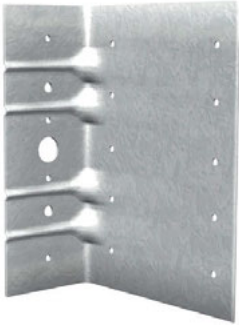

ClarkDietrich EasyClip™ T-Series™ tall anchor clips are high-performance, cost-effective solutions for knee wall-to-foundation connections, light-duty shearwall-to-foundation connections and truss-to-wall connections. They are designed to resist horizontal, torsional and vertical (uplift) loads.

Product code	Thickness			Size (in)	Packaging Pcs./Bucket
	Gauge	Mils	Design thickness (in)		
T683	14	68	0.0713	2 x 4 x 3-1/2	40
T685				2 x 4 x 5-1/2	
T973	12	97	0.1017	2 x 4 x 3-1/2	
T975				2 x 4 x 5-1/2	

EasyClip™ U-Series™ CLIP ANGLE

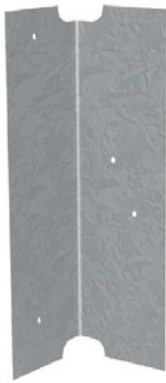

ClarkDietrich EasyClip™ U-Series™ clip angles are used to secure U-channel to wall studs for lateral bridging or for miscellaneous rigid connections. U-channel is passed through the stud knockout and an EasyClip U-Series clip is screw-attached or welded to provide a rigid connection. These clips are prepunched for faster, more accurate fastener placement. Do not use in bridging applications when the stud width exceeds 6".

Product code	Thickness			Size (in)	Packaging Pcs./Bucket
	Gauge	Mils	Design thickness (in)		
U543	16	54	0.0566	1-1/2 x 1-1/2 x 3-3/8	400
U545				1-1/2 x 1-1/2 x 5-3/4	200
U547				1-1/2 x 1-1/2 x 7-3/4	100
U549				1-1/2 x 1-1/2 x 9-3/4	100
U683	14	68	0.0713	1-1/2 x 1-1/2 x 3-3/8	200
U685				1-1/2 x 1-1/2 x 5-3/4	170
U687				1-1/2 x 1-1/2 x 7-3/4	100
U689				1-1/2 x 1-1/2 x 9-3/4	100
U973	12	97	0.1017	1-1/2 x 1-1/2 x 3-3/8	200
U975				1-1/2 x 1-1/2 x 5-3/4	130
U977				1-1/2 x 1-1/2 x 7-3/4	100
U979				1-1/2 x 1-1/2 x 9-3/4	80

EasyClip B-Series™ CLIP ANGLE



ClarkDietrich EasyClip B-Series™ clip angles are used to secure U-channel to wall studs in back-to-back framing applications and for various miscellaneous rigid connections. The shorter length of the B-Series clip enables it to be installed inside the C-shape. It can also be used to secure lateral bridging on single studs where the clip is preferred to be inside the C-shape. Do not use in lateral bridging when stud width exceeds 6".

Product code	Thickness			Size (in)	Packaging Pcs./Bucket
	Gauge	Mils	Design thickness (in)		
B543	16	54	0.0566	1-1/2 x 1-1/2 x 3	400
B545				1-1/2 x 1-1/2 x 5-1/4	200
B547				1-1/2 x 1-1/2 x 7-1/4	100
B549				1-1/2 x 1-1/2 x 9-1/4	100
B683	14	68	0.0713	1-1/2 x 1-1/2 x 3	200
B685				1-1/2 x 1-1/2 x 5-1/4	170
B687				1-1/2 x 1-1/2 x 7-1/4	100
B689				1-1/2 x 1-1/2 x 9-1/4	100
B973	12	97	0.1017	1-1/2 x 1-1/2 x 3	200
B975				1-1/2 x 1-1/2 x 5-1/4	130
B977				1-1/2 x 1-1/2 x 7-1/4	100
B979				1-1/2 x 1-1/2 x 9-1/4	80

EasyClip X-Series™ CLIP ANGLE



ClarkDietrich EasyClip X-Series™ clip angles are used to secure U-channel to wall studs for lateral bridging. U-channel is passed through the stud knockout and an EasyClip X-Series clip is screw-attached or welded to provide a rigid connection. X-Series clip angles and U-channel should not be used in lateral bridging when stud width exceeds 6".

Product code	Thickness			Size (in)	Packaging Pcs./Bucket
	Gauge	Mils	Design thickness (in)		
X543	16	54	0.0566	2 x 2 x 3-3/8	200
X545				2 x 2 x 5-3/4	170
X547				2 x 2 x 7-3/4	100
X549				2 x 2 x 9-3/4	100
X683	14	68	0.0713	2 x 2 x 3-3/8	200
X685				2 x 2 x 5-3/4	100
X687				2 x 2 x 7-3/4	100
X689				2 x 2 x 9-3/4	80
X973	12	97	0.1017	2 x 2 x 3-3/8	100
X975				2 x 2 x 5-3/4	100
X977				2 x 2 x 7-3/4	60
X979				2 x 2 x 9-3/4	60

Spazzer® 9200 SPACER AND BRIDGING BAR



The TradeReady® Spazzer® 9200 bar is a pre-notched, 20 gauge, galvanized steel spacer and bridging bar. It facilitates rapid erection of studs into a rigid, accurately laid out gridwork that has excellent resistance to stud rotation and displacement. Hanging drywall is also faster and easier because the Spazzer 9200 bar eliminates the bow that often occurs in tall interior studs.

Product code	Thickness			Size (in)	Packaging	
	Gauge	Mils	Design thickness (in)		Pcs./Box	Pcs./Skid
SPZD	20	33	0.0346	7/8 x 7/8 x 50	N/A	1350

- Eliminates stud spacing layout at deck
- Improves drywall installation speed
- Automatically positions and rigidly holds studs on 16" or 24" centers without fasteners
- Eliminates clip angles and the labor required to install them

U.S. Patent Nos. 5,784,850 and 6,021,618

Spazzer 5400



ClarkDietrich TradeReady Spazzer 5400 spacer bar is a galvanized steel spacer and bridging bar, engineered to facilitate the rapid erection of exterior curtain wall framing, load-bearing walls and high interior partitions constructed of structural studs. Proprietary prepunched slots provide excellent torsional and lateral stud restraint.

Product code	Thickness			Size (in)	Packaging	
	Gauge	Mils	Design thickness (in)		Pcs./Bundle	Pcs./Skid
SPZS	16	54	0.0566	1-1/4 x 1-1/4 x 50	N/A	680

- Fast, easy and efficient
- Reduces labor up to 40%
- Eliminates clip angles, bridging clips and welding
- Pre-notched at 12," 16" and 24" intervals so no layout is required

U.S. Patent No. 6,708,460 and other patents pending.

Spazzer Bar Guard™



Used to secure the Spazzer 5400 spacer bar when used in load-bearing applications.

Product code	Size (in)	Packaging Pcs./Carton
SPBG	3-1/4 x 1-5/8	100

Spazzer BAR FLY CLIP



The Spazzer fly clip is a secure, fast and efficient way to finish a wall section. This prepunched clip eliminates the need for cutting and bending when using the Spazzer 5400 spacer bar.

Product code	Size (in)	Packaging Pcs./Carton
SFLY	1 x 1-1/4 x 1	100

Danback® WOOD BACKING PLATE



Just snap, flex and screw. It's that fast.

Danback® is a heavy-duty, flexible wood backing system used to support cabinets, shelves, handrails, wall-mounted sinks and counters, and all other wall-mounted fixtures. Danback provides superior connection shear and pullout strength to support and meet even some of the heaviest loading conditions. The patented hinge design actually flexes around the stud and snaps into place for a perfect fit—every time.

Product code	Width (in)	Length (in)	Packaging Pcs./Skid
D16F*	5-1/8	48	250
D24F*			
D16C**			
D24C**			

- Reduces installation time up to 90%
- Available for 16" and 24" o.c. framing
- Eliminates cutting, notching, ripping and routing
- Made with Dricon® fire-retardant treated wood
- Complies with all national building codes

Dricon® is a registered trademark of Arch Wood Protection, Inc. Danback® is a registered trademark of Daniel W. Tollenaar. U.S. Patent No. 6,705,056 of Daniel W. Tollenaar.

*F = fire-treated plywood. D16 = 16" o.c. spacing. D24 = 24" o.c. spacing.

Trimables available for off-module spacing in small bucket or bulk quantities.

**FSC-certified lumber available on request, which can contribute to LEED® points on your project. Contact ClarkDietrich LEED professionals at 888-437-3244 for more information. FSC chain-of-custody # BV-COC-008121.

Katz™ BLOCKING



ClarkDietrich Katz™ blocking is specifically manufactured to ladder frame between parallel framing members and provide for the attachment of the top of the interior nonstructural walls when trusses or floor joists run parallel to the walls. Katz blocks are secured to the floor joists or roof trusses with screws or nails.

Product code	Size (in)	Length (in)
KA	3-5/8	16
		24

FastBack™ BACKING CLIP



For use with the FastBack™ backing system, the FastBack backing clip conceals fasteners on the face of the product. Rotate the FastBack clip over the flange of the stud until it sits flush. Then fasten into place using drywall screws in the pre-drilled holes.

Product code	Width (in)	Length (in)	Packaging Pcs./Carton
FBBC	1-1/4	5-1/8	100
FBBC	1-1/4	10-1/4	100

U.S. Patent No. 7,882,676 is owned by Jeffery Thomas Ellis.

G-Series™ PUNCHED GUSSET PLATES

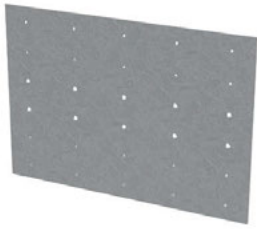

G-Series™ punched gusset plates are multipurpose connectors used in a variety of framing connections including roof framing, header framing and shear wall applications. They adapt to multiple configurations and varying construction tolerances.

Product code	Thickness			Size (in)	Packaging Pcs./Bucket
	Gauge	Mils	Design thickness (in)		
G436	18	43	0.0451	6 x 8-1/2	50
G546	16	54	0.0566	6 x 8-1/2	
G686	14	68	0.0713	6 x 8-1/2	

GP-Series™ UNPUNCHED GUSSET PLATES



GP-Series™ unpunched gusset plates are used to facilitate connections between chord members for in-plane framing and anchoring diagonal tension strapping to corner studs for shearwalls. Adapts to multiple configurations and varying construction tolerances.

Product code	Thickness			Plate size (in)	Packaging Pcs.
	Gauge	Mils	Design thickness (in)		
GP	16	54	0.0566	6 x 6	25
				6 x 12	
				12 x 12	
GP	12	97	0.1017	6 x 6	25
				6 x 12	
				12 x 12	

H-Series™ UNIVERSAL HEADER HANGER

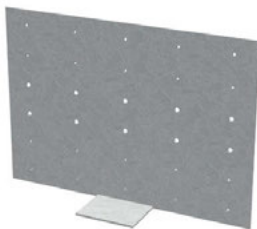

The H-Series™ universal header hanger is used to connect box headers to jambs, or beams to columns, and transfer large vertical loads. This universal hanger is designed so one part can be used for either side of the connection. The hanger also features a support tab for proper alignment and easy installation.

Product code	Thickness			Size (in)	Packaging Pcs./Bucket
	Gauge	Mils	Design thickness (in)		
H436	18	43	0.0451	6 x 8-1/2	50
H546	16	54	0.0566	6 x 8-1/2	
H686	14	68	0.0713	6 x 8-1/2	

EasyClip™ E-Series™ SUPPORT CLIP

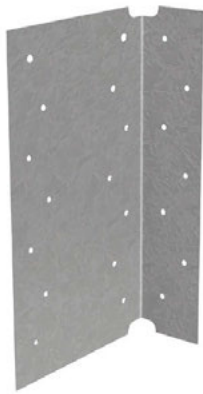

ClarkDietrich EasyClip™ E-Series™ support clips are used for rigid standoff connections. The 4" wide leg provides extra length to achieve standoff connections up to 3". These support clips are commonly used in bypass wall conditions, solid blocking attachments in joist framing, and to secure rafter framing to the primary structure. EasyClip E-Series support clips are prepunched for faster and more accurate fastener placement.

Product code	Thickness			Size (in)	Packaging Pcs./Bucket
	Gauge	Mils	Design thickness (in)		
E543	16	54	0.0566	4 x 1-1/2 x 3	100
E545				4 x 1-1/2 x 5	100
E547				4 x 1-1/2 x 7	100
E549				4 x 1-1/2 x 9	50
E541				4 x 1-1/2 x 11	50
E683	14	68	0.0713	4 x 1-1/2 x 3	100
E685				4 x 1-1/2 x 5	100
E687				4 x 1-1/2 x 7	80
E689				4 x 1-1/2 x 9	50
E681				4 x 1-1/2 x 11	50
E973	12	97	0.1017	4 x 1-1/2 x 3	50
E975				4 x 1-1/2 x 5	50
E977				4 x 1-1/2 x 7	50
E979				4 x 1-1/2 x 9	50
E971				4 x 1-1/2 x 11	40

EasyClip S-Series™ SUPPORT CLIP

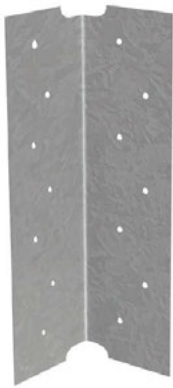

ClarkDietrich EasyClip S-Series™ support clips are used for rigid connections in window and door framing, joist, bypass or other miscellaneous connections to secure one framing member to another, or to secure framing members to the structural frame. EasyClip S-Series clips are prepunched for faster and more accurate fastener placement.

Product code	Thickness			Size (in)	Packaging Pcs./Bucket
	Gauge	Mils	Design thickness (in)		
S543	16	54	0.0566	1-1/2 x 1-1/2 x 3	400
S545				1-1/2 x 1-1/2 x 5	200
S547				1-1/2 x 1-1/2 x 7	100
S549				1-1/2 x 1-1/2 x 9	100
S541				1-1/2 x 1-1/2 x 11	100
S683	14	68	0.0713	1-1/2 x 1-1/2 x 3	200
S685				1-1/2 x 1-1/2 x 5	200
S687				1-1/2 x 1-1/2 x 7	100
S689				1-1/2 x 1-1/2 x 9	100
S681				1-1/2 x 1-1/2 x 11	100
S973	12	97	0.1017	1-1/2 x 1-1/2 x 3	200
S975				1-1/2 x 1-1/2 x 5	150
S977				1-1/2 x 1-1/2 x 7	100
S979				1-1/2 x 1-1/2 x 9	80
S971				1-1/2 x 1-1/2 x 11	70

EasyClip QuickTwist™ WEB STIFFENER



EasyClip QuickTwist™ web stiffeners are used to provide reinforcement of joist webs to prevent crippling. Web reinforcement is often required by design to enhance the load capacity of joists. The unique design of QuickTwist allows the installer to insert the stiffener on the inside of the joist after the joist is installed. This stiffener eliminates the need to pre-insert traditional web stiffeners prior to joist installation.

Product code	Size (in)	Thickness			Height* (in)	Packaging
		Gauge	Mils	Design thickness (in)		
QTWS	3-1/2	12	97	0.1017	7-1/4	Dependent on order quantity
					8	
					9-1/4	
					10	
					11-1/4	
QTWS	6	12	97	0.1017	7-1/4	Dependent on order quantity
					8	
					9-1/4	
					10	
					11-1/4	
					12	
					14	

*Dimension is nominal size. Actual product is shorter to fit inside joist.

Uni-Clip™ END CLIP



ClarkDietrich's Uni-Clip™ end clip is a universal framing clip used to attach and support numerous rigid framing conditions. The Uni-Clip framing clip has a stiffened corner that provides superior design values and is installed easily with screws or powder-actuated fasteners. This clip is ideal for most rigid connections, including shear, tension and two-axis loading.

Product code	Thickness			Size (in)	Packaging Pcs./Carton
	Gauge	Mils	Design thickness (in)		
UCEC	14	68	0.0713	3-1/2 x 1-1/2 x 4-1/2	25

U.S. Patent No. 6,688,069

FIELD SKEWABLE TradeReady® RIM TRACK SPLICE PLATE



The ClarkDietrich field skewable TradeReady® rim track splice plate provides an easy and efficient method for splicing TradeReady rim. This prepunched plate is also ideal for connecting and reinforcing the rim at bay or bow window details. The center of the plate allows for easy one-time field bending from 0° to 135°.

Product code	Thickness			Size (in)	Packaging Pcs./Box
	Gauge	Mils	Design thickness (in)		
TDSP	18	43	0.0451	4 x 6	100
TDSP	16	54	0.0566	4 x 6	100

CAUTION: This plate can only be bent one time.

G-Series™ PUNCHED GUSSET PLATES

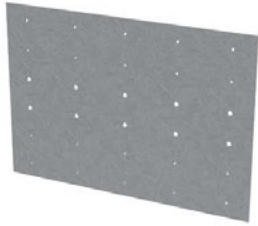

G-Series™ punched gusset plates are multipurpose connectors used in a variety of framing connections including roof framing, header framing and shearwall applications. They adapt to multiple configurations and varying construction tolerances.

Product code	Thickness			Size (in)	Packaging Pcs./Bucket
	Gauge	Mils	Design thickness (in)		
G436	18	43	0.0451	6 x 8-1/2	50
G546	16	54	0.0566	6 x 8-1/2	
G686	14	68	0.0713	6 x 8-1/2	

GP-Series™ UNPUNCHED GUSSET PLATES



GP-Series™ unpunched gusset plates are used to facilitate connections between chord members for in-plane framing and anchoring diagonal tension strapping to corner studs for shearwalls. Adapts to multiple configurations and varying construction tolerances.

Product code	Thickness			Plate size (in)	Packaging Pcs.
	Gauge	Mils	Design thickness (in)		
GP	16	54	0.0566	6 x 6	25
				6 x 12	
				12 x 12	
GP	12	97	0.1017	6 x 6	25
				6 x 12	
				12 x 12	

Uni-Clip™ END CLIP



ClarkDietrich's Uni-Clip™ end clip is a universal framing clip used to attach and support numerous rigid framing conditions. The Uni-Clip framing clip has a stiffened corner that provides superior design values and is installed easily with screws or powder-actuated fasteners. This clip is ideal for most rigid connections, including shear, tension and two-axis loading.

Product code	Thickness			Size (in)	Packaging Pcs./Carton
	Gauge	Mils	Design thickness (in)		
UCEC	14	68	0.0713	3-1/2 x 1-1/2 x 4-1/2	25

U.S. Patent No. 6,688,069

CLIPS AND CONNECTORS

EasyClip™ E-Series™ SUPPORT CLIP



ClarkDietrich EasyClip™ E-Series™ support clips are used for rigid standoff connections. The 4" wide leg provides extra length to achieve standoff connections up to 3". These support clips are commonly used in bypass wall conditions, solid blocking attachments in joist framing, and to secure rafter framing to the primary structure. EasyClip E-Series support clips are pre-punched for faster and more accurate fastener placement.

Product code	Thickness			Size (in)	Packaging Pcs./Bucket
	Gauge	Mils	Design thickness (in)		
E543	16	54	0.0566	4 x 1-1/2 x 3	100
E545				4 x 1-1/2 x 5	100
E547				4 x 1-1/2 x 7	100
E549				4 x 1-1/2 x 9	50
E541				4 x 1-1/2 x 11	50
E683	14	68	0.0713	4 x 1-1/2 x 3	100
E685				4 x 1-1/2 x 5	100
E687				4 x 1-1/2 x 7	80
E689				4 x 1-1/2 x 9	50
E681				4 x 1-1/2 x 11	50
E973	12	97	0.1017	4 x 1-1/2 x 3	50
E975				4 x 1-1/2 x 5	50
E977				4 x 1-1/2 x 7	50
E979				4 x 1-1/2 x 9	50
E971				4 x 1-1/2 x 11	40

EasyClip T-Series™ TALL ANCHOR CLIP

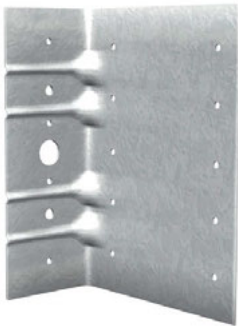

ClarkDietrich EasyClip T-Series™ tall anchor clips are high-performance, cost-effective solutions for knee wall-to-foundation connections, light-duty shearwall-to-foundation connections and truss-to-wall connections. They are designed to resist horizontal, torsional and vertical (uplift) loads.

Product code	Thickness			Size (in)	Packaging Pcs./Bucket
	Gauge	Mils	Design thickness (in)		
T683	14	68	0.0713	2 x 4 x 3-1/2	40
T685				2 x 4 x 5-1/2	
T973	12	97	0.1017	2 x 4 x 3-1/2	
T975				2 x 4 x 5-1/2	

ALUMINUM BURN CLIP



ClarkDietrich aluminum burn clips are used as part of the H-stud area separation wall assembly and are designed to melt when exposed to fire. The clips hold the area separation wall assembly in place at the floor, roof and truss line between adjacent units. In a fire, the aluminum burn clips on the fire-ridden side of the wall will melt, allowing the wall structure for that side to collapse.

Product code	Thickness (in)	Size (in)	Packaging Pcs./Bucket
AB	0.050	2 x 2 x 2-1/2	500
AB63*	0.063	2 x 2 x 2-1/2	500

*AB63 meets requirements of ICC-ES Legacy Report 92-19.

RESILIENT SOUND ISOLATION CLIP



The RSIC-1® resilient sound isolation clip is used in conjunction with drywall furring channel to fasten gypsum wallboard to various wall and floor-ceiling designs and applications, while simultaneously providing acoustical separation (decoupling). This significantly reduces the amount of impact and sound that filters from surrounding rooms—reducing the noise transfer by 75 to 100%.

Product code	Pcs./Bucket
RSIC-1	200

U.S. Patent No. 6,267,347 of MTEC, LLC. The RSIC-1 clip is a registered trademark of MTEC, LLC. UL and UL Classified are registered trademarks of Underwriters Laboratories, Inc.



METAL FURRING CHANNEL CLIP



ClarkDietrich metal furring channel clips are made of galvanized wire and used to attach metal furring channels to 1-1/2" U-channels in ceiling gridwork. Clips must be installed on alternating sides of the 1-1/2" channels. Use tie wire when clips cannot be alternated. Clips should only be used when single-layer gypsum or single-layer veneer plaster base is used.

Product code	Pcs./Bucket
MFCC	500

CUSTOM FABRICATED CLIPS AND CONNECTORS



When the job calls for a connection, clip or support that doesn't exist in this catalog, ClarkDietrich can create whatever you need. We can custom fabricate just about any shape, bend, angle or specialty framing clip, connector or support to your exact specification. Manufactured using precision cutting and forming equipment, a diverse selection of specialized sizes and shapes is available—including prepunched holes and/or specialized slots. Simply submit your dimensioned drawings to your ClarkDietrich representative, and we'll do the rest!

Note: The performance and installation of custom-made products is the sole responsibility of the design professional and engineer of record. Any customer ordering a custom-fabricated clip, connector or support shall indemnify, defend and hold harmless ClarkDietrich and ClarkDietrich Engineering Services for any loss or damage arising in whole or in part.



Product Name Index

#4 Short Flange Corner Bead	83
#701A Metal J-Trim	82
#701B Metal L-Trim	82
093 Control Joints	64, 70, 79
103 Deluxe Corner Bead	60

A

A-Series	93
Anchor Clip	93-94
Archway Bead	66-67
Area Separation Wall Systems	32-33
Aluminum Burn Clip	33, 103

B

B-Series	25, 92, 95
Backing Clip	26, 97
Backing Plate	26, 27, 97
Barrier Mesh	74
Bridle Hanger	55
Bullnose Corner Beads	61-63, 66-68, 70

C

C-Joist Framing	52
C-Runner	33
C-Studs	35
CH-Stud	31
CT Shaftwall	29
Casing Bead	76-77, 85
Channel Clip	13, 103
Clinch-On Products	60-61
Clip Angle	25, 48, 92, 95
Clip Express	4
Clips and Connectors	87-104
Contact Information	5
Contour Track	12
Corner Angle	13, 37
Corner Caps	62-63, 67-68
Corner Master #30	78
Cornerite	74
Custom Clips and Connectors	104
Custom Shapes	37, 104

D

D-Series	93
Danback Wood Backing Plate	26, 97
Deep Leg Deflection Track	20, 44
Deflection Track	20, 44
Diagonal Tension Strapping	48, 53
Drop 'N Lock Clip	21, 39
Double Track	20, 44
Double-J Control Joint	78
Double-V Control Joint	78, 85
Double-X Corner Bead	76

E

E-Series	54, 91, 99, 102
E-Stud	31
EasyClip	25, 48, 52, 54, 91-95, 99, 102
End Clip	91, 93, 100, 101
Engineering Services	4
Expansion Joint #40	79
Exterior Framing	34-49

F

Fast Strut	88
Fast Top Clip	20, 45, 90
FastBack Backing Clip	26, 97
FastClip Slide Clip	88
FastHook FastClip Slide Clip	88
Fast Strut	88

Field Skewable TradeReady Splice Plate	100
Flat Strapping	26, 48, 53
Flat Tail Slide Clip	89
Floor Framing	50-55
Foundation Weep Screed	80-81, 86
Furring Channel	14, 37
Furring Channel Clip	13, 103

G

G-Series	98, 101
GP-Series	98, 101
Galvanized Junior Mesh Lath	72
General Notes	7
Goldline Paper-Faced Beads	56-59
Grommets	13, 36, 46
Gusset Plates	48, 98, 101

H

H-Series	98
H-Stud	33
HDS Framing System	22, 40, 49
HDS Header Bracket	22, 40
Head-of-Wall Deflection Systems	19-20
Heavy-Duty Furring Channel	37
Heavy-Duty Stud	22, 40
High Rib Lath	73
How to Use This Catalog	6

I

Interior Contour Track	12
Interior Finishing	56-70
Interior Framing	9-33

J

J-Bead	63, 68, 70
J-Runner	29, 31
J-Tabbed Track	29
J-Weep	80-81, 86
Jamb Strut	31
Joist Hanger	55
Junior Mesh	72

K

Katz Blocking	27, 97
Knockouts	36
ksi	6

L

L-Bead	64, 69
L-Header	49
L-Series	47
LA-Series	47
LE-Series	47
LS-Series	24, 47, 93
LEED Information	8
Locations	5

M

MaxTrak Slotted Deflection Track	19, 42
Mega Lath	75
Metal Corner Beads	60-64
Metal Lath and Accessories	71-86
Metric Specifications	7
Mini-Bead 800/900	64, 82
Miscellaneous Angles	37

N

Notched Track	27
---------------	----

O

—

P

Paper-Faced Beads	56-59
Partition End Cap	69
Plastic Grommets	13, 36, 46
Product Availability	7
Product Identification	6
Product Labeling	7
Product Substitution	6
ProSTUD Drywall Framing System	10-11
ProSTUD Sound Assemblies	15
ProTRAK	11
Protective Coatings	6
ProX Clip	23, 41
ProX Header System	23, 41

Q

QuickClip	89
Quicksilver	60
QuickTwist	52, 99

R

RC-1 Pro	16
RC-1 ProPlus	17
RC-2 Pro	17
RC-2 ProPlus	17
RC-Deluxe	16
RSIC-1 Clip	18, 103
RedHeader RO	21, 38-39
Resilient Channel	16, 17
Resilient Channel Installation	18
Resilient Sound Isolation Clip	18, 103
Rip Bead	69
Rough Openings	21-23, 38-41, 49

S

S-Series	54, 91, 99
Self-Furring Dimpled Lath	72
Self-Furring V-Groove Mesh Lath	72
SFIA	7
SLP-TRK	19, 43
Seismic SLP-TRK	43
Shaftwall Systems	28-31
Shearwall Bracing	48
Simpson Strong-Tie	55
Skewable Angle	55
Slide Clip	88, 89
Slotted Track	19, 42, 43
Sound Assemblies	15-18, 103
Sound-Rated Systems	15-18, 103
Spazzer Bar	24, 46, 96
Spazzer Bar Fly Clip	46, 96
Spazzer Bar Guard	46, 96
Spazzer Snap-In Grommet	46
Splayed Corner Bead	61
Spray Rib Lath	73
Standards & Specifications	7
Steel Thickness	7
Strip Lath	74
StructaLath	75
Structural Track	36, 53
Stucco Accessories	74, 76-86
Stucco Corner Bead	76, 84-85
Support and Services	4
Support Clip	24, 47, 54, 91, 93, 99, 102
SwiftClip	24, 47, 93

Product Name Index

T	
T-Series	94, 102
Table of Contents	3
Tension Bracing	54
Tile Cap	83
TradeReady Floor System	50-52
TradeReady Header	49
TradeReady Rim	51
TradeReady Steel Joist	51
TradeReady Structural Blocking	52
Twin Trac	75
U	
U-Bead	63
U-Channel	24, 47
U-Series	25, 48, 92, 95
USG Shaftwall Systems	30-31
USG CH-Stud	31
USG E-Stud	31
USG J-Runner	31
USG Jamb Strut	31
Uni-Clip End Clip	91, 100, 101
Universal Header Hanger	98
Utility Lath	72
V	
V Truss	75
Vinyl Archmaker Corner Bead	84
Vinyl Bullnose Archmaker Corner Bead	85
Vinyl Corp	65
Vinyl Drywall Trims	65-70
Vinyl Stucco Corner Beads	84-85
Vinyl Stucco Control Joints	85-86
Vinyl Stucco Trims	84-86
W	
Web Stiffener	52, 53, 99
Wire Corner Reinforcement	82
X	
X-Series	25, 92, 95
Y	
Yield Strength	6
Z	
Z-Furring	14
Zinc Control Joints	64, 79

Product Code Index

#4	83	FHA7	80
A		FHC	88
A-Series	93	FS12, 15	88
AB	33, 103	FTC3/FTC5	20, 45, 90
B		FTSC	89
B-Series	25, 92, 95	G	
BDTK	19, 43	G436	98, 101
BJB50/58	70	G546	98, 101
BJB50S/58S	70	G686	98, 101
BM10	74	GP	48, 98, 101
BM15	74	GROM	13, 36
BM50	74	H	
BM75	74	H436	98
BPE	27	H546	98
BPN	27	H686	98
C		HCN90	13
CAE	37	HDS	22, 40, 49
CAE 90	13	HDSC	22, 40
CAEW 135	13	HEAD	21, 38
CAM	37	HRN1	33
CAN 90	13	HSN	33
CANW 135	13	J	
CB12	61	JAMB	21, 39
CBB	61	JCLB	80
CBBK	62	JWL	80
CBBW	61	JWP	81
CBCO	60	K	
CBCS	61	KA	97
CBS	60	KATZ	27
CBU	60	L	
CBXA	76	L-Series	47
CBXX	76	LAD (O)	72
CBZA	76	LADU (O)	73
CDBV	55	LAM (O)	72
CDMB	55	LAMU (O)	73
CETB	12	LAR	73
CHN	24, 47	LARS	73
CNTB	12	LAST	74
CR30	78	LAV (O)	72
CSE	35, 52	LHDR	49
CSJ	35, 52	LS-Series	24, 93
CSS	35, 52	M	
CSW	35, 52	M20A	63
CTE	29	M20B	64
CTN	29	M285	62, 67
CWN	35	M385	62, 67
D		M400	63
D-Series	93	M401	63
D16, D24	26, 97	M402	63
DNLC	21, 39	M71A	82
DTN	26, 48, 53	M71B	82
DTNC	48	M81A	82
E		M81B	82
E-Series	54, 91, 99, 102	M859	63, 68
EJ40	79	MAX	19, 42
EZ40	79	MB80	64, 82
F		MB90	64, 82
FBBC	26, 97	MFCC	13, 103
FCE	14	N	
FCED	14	NOTC	27
FCM	14, 37	O	
FCMD	14, 37	OTSB	20
FCN	14	OTSC	20, 44
FCND	14	OTSE	20, 44
FCSC	88		

P	
P00B	58
P0BO	58
P100	57
P1BN	58
P1BO	58
P1SU	57
P1UO	57
P1WO	57
P1XU	57
P1XW	57
P2BI	59
P2I	57
P20I	57
P4L	59
PEC50/58	69
PGR	59
PROS	11
PROT	11
PXH	23, 41
PXT	23, 41
PXTC	23, 41
Q	
QC	89
QTWS	52, 99
R	
RCDE	17
RCDN	17
RCSD	16
RCUR	16-17
RSIC-1	18, 103
S	
S-Series	54, 91, 99
S/JCT	55
SD	89
SFCB	77
SFLY	46, 96
SFWB	77
SFZB	77
SI36	80
SLS5	55
SLS7	55
SPBG	46, 96
SPGR	46
SPZD	24, 96
SPZS	46, 96
T	
T-Series	94, 102
T20	54
T27	54
T36	54
TC127	83
TD12, 16, 19, 24	51
TDHA	49
TDHB	49
TDJ	51
TDSB	52
TDSP	100
TDW	51
TSA	36
TSB	36, 53
TSC	20, 36, 44
TSD	36
TSE	20, 36, 44
TSF	36
TTE	29
TTN	29
TZ154	83
U	
U-Series	25, 48, 92, 95
UCEC	91, 100, 101
USG CH	31
USG ES	31
USG JR	31
USG JS	31
V	
VBAB	67
VBCB	66
VBKB	66
VBSB	66
VCJT	70
VLAB	66
VLCB	65
VLJB	68
VLLS	69
VLMJ	68
VLSB	65
VLZL	69
VVCJ	78
VVJZ	78
W	
W951	83
WS	53
X	
X-Series	25, 92, 95
XJ15	78
XRIT	74
XXCB	76
XXCW	77
XXZB	76
XXZW	77
Z	
Z71A	82
Z71B	82
Z81A	82
Z81B	82
ZB80	64, 82
ZB90	64, 82
ZCJ1	79
ZCJ3	79
ZCJ5	79
ZCJ7	79
ZFE	14
ZFN	14
ZJ15	78
ZNCJ	64, 79

PATENTS AND TRADEMARKS

Patents

U.S. Patent Nos. 5,689,922; 5,784,850; 5,816,002; 6,021,618; 6,070,374; 6,301,854; 6,418,694; 6,688,069; 6,691,478; 6,691,487; 6,708,460; 6,761,005; 7,240,459

Canadian Patent No. 2319346

Mexican Patent No. 243294

U.S. Patent No. 5,836,133 is owned by B&D Industries, Inc.

U.S. Patent Nos. 6,799,408 and 7,178,304 are owned by Brady Construction Innovations

U.S. Patent No. 6,230,467 is owned by Simpson Strong-Tie Company, Inc.

U.S. Patent No. 6,705,056 is owned by Daniel W. Tollenaar

U.S. Patent No. 6,267,347 is owned by MTEC, LLC

U.S. Patent No. 7,882,676 is owned by Jeffery Thomas Ellis

GOLDLINE® Trims are covered under the following patents:

U.S. Patent Nos. 5,836,122 and 5,613,335

Canadian Patent No. 2,212,854

Australian Patent No. 69582

New Zealand Patent No. 302378

PLATINUM® Trims (separate patent) are covered under the following:

U.S. Patent No. 7,214,434 B2

Canadian Patent No. 2,417,325

Australian Patent No. 2004202648

New Zealand Patent No. 533606

Trademarks

ClarkDietrich is a trademark of ClarkDietrich Building Systems.

TradeReady®, Spazzer®, FastClip™, EasyClip™, Fast Top™, Fast Strut™, Uni-Clip™, Clip Express™, Drop 'N Lock Clip™, Stronger Than Steel™, FastBack™, HDS®, RedHeader RO™, QuickTwist™, Slide Clip™, SubmittalPro®, SwiftClip™, A-Series™, B-Series™, D-Series™, E-Series™, G-Series™, GP-Series™, H-Series™, L-Series™, LS-Series™, LE-Series™, LA-Series™, S-Series™, T-Series™, U-Series™, X-Series™, QuickClip™, MaxTrak®, Bar Guard™, DoubleTrack™, QC-Series™, ProSTUD®, ProTRAK®, Contour Track®,

Deluxe®, RC-Deluxe™, QuickSilver™, Rip Bead™, Cornerite™, Junior™, Katz™, C-Series™, CWN™, CSJ™, CSW™, CSE™, CSS™, Double-X™, Corner Master™, Mini-Bead™ and Archmaker™ are owned by ClarkDietrich Building Systems.

DriCon® is a registered trademark of Arch Wood Protection, Inc.

LEED® is a registered trademark of the U.S. Green Building Council.

Danback® is a registered trademark of Daniel W. Tollenaar.

Simpson® and Simpson Strong-Tie® are trademarks of Simpson Strong-Tie Company, Inc.

UL® and UL Design® are trademarks of Underwriter's Laboratories, Inc.

ProX Header® and SLP-TRK® are registered trademarks of Brady Construction Innovations.

RSIC-1® is a registered trademark of MTEC, LLC.

Structalath®, Twin Trac® and V Truss® are registered trademarks of Structa Wire Corp.

Mega Lath™ is a trademark of Structa Wire Corp.

Goldline® and Platinum® are registered trademarks of Bailey Metal Products, Ltd.

USG Sheetrock® is a registered trademark of USG Corporation.

WARRANTY

Warranty

Our products are manufactured in accordance with company standards and/or industry standards, as applicable. All ClarkDietrich Building Systems products are covered by our standard warranty which is contained in our Standard Terms and Conditions of Sale and which will be provided upon request. Generally, we warrant our products will be free from defects in material and workmanship at the time of shipment, subject to the limitations stated in the warranty. Unless specifically agreed in writing by us with respect to specific orders, we do not make any warranty of merchantability or fitness for a particular purpose. The buyer is responsible to assure that buyer orders the appropriate product for any applicable code or specification requirements.

NOTICE: Our liability is expressly limited to replacement of defective products. We shall not be liable for incidental and consequential damages, nor for any loss caused by misuse or misapplication of our products. Any claim shall be deemed waived unless made in writing to us within thirty (30) days from the date it was or reasonably should have been discovered.

CODE APPROVALS AND PERFORMANCE STANDARDS

ClarkDietrich products meet or exceed these applicable performance standards.

AISI "North American Specification for the Design of Cold-Formed Steel Structural Members, AISI S-100-2007 with 2010 supplement

ASTM American Society for Testing and Materials

Product specifications

ASTM C645	Non-structural steel framing members
ASTM C955	Load-bearing steel framing
ASTM C847	Plastering steel products
ASTM C841/C1063	Veneer and plaster accessories
ASTM C1047	Beads and trims—metal—paper—vinyl

Material specifications

ASTM A1003 (NS33, ST33L, ST33H, ST50L, ST50H)	
ASTM A653	Zinc-coated hot-dip process
ASTM A653/B69	Veneer and plaster accessories

Protective coating standards

ASTM C645	Non-structural steel framing members
ASTM C955	Load-bearing steel framing
ASTM A653	Zinc-coated hot-dip process
ASTM C1063	Veneer and plaster accessories
ASTM C1047	Beads and trims—metal—paper—vinyl

UL® Underwriters Laboratories testing standard

UL 263 "Fire Tests of Building Construction and Materials"

Additional code approvals

International Building Code

ClarkDietrich Building Systems is a proud member of the Steel Framing Industry Association (SFIA). Check the updated list of Certified Production Facilities at Architectural Testing's website at www.archtest.com.



Scan for the most up-to-date ClarkDietrich literature.

LEED® Credit MR 2

Construction Waste Management (Up to 2 points)

ClarkDietrich products are manufactured from cold-formed steel. Steel is 100% recyclable, which helps divert debris from the waste stream. The contribution to LEED must be calculated by the contractor based on weight or volume.

LEED Credit MR 4 Recycled Content (Up to 3 points)

ClarkDietrich's steel products have a minimum of 25.5% post-consumer recycled content, and 6.8% pre-consumer. If you wish to report a higher number for your project or seek Credit MR 5 regional materials, please contact Tech Services at 888-437-3244 or clarkdietrich.com.

ClarkDietrich Building Systems has prepared this literature with the utmost diligence and care for accuracy and conformance to standards.

ClarkDietrich intends this information to be accurate, informative, and helpful as a selection guide for choosing ClarkDietrich Building System products. However, this information is only to be used for guidance and is not intended to replace the design, drawings, specifications, and decisions of a professional architect or engineer.

ClarkDietrich Building Systems or its affiliates shall not be responsible for incidental or consequential damages, directly or indirectly sustained, nor for loss caused by application of our products for other than their intended uses. Our liability is limited to replacement of defective products. Claims shall be deemed waived unless they are made to us in writing within thirty (30) days of the date a problem was or reasonably should have been discovered.

ClarkDietrich Building Systems reserves the right to modify or change any information contained in this literature without notification.



USGBC and related logo is a trademark owned by the U.S. Green Building Council and is used by permission.

LOCATIONS

ClarkDietrich Building Systems Manufacturing and Sales Locations:

CALIFORNIA Riverside
P 951.360.3500
F 951.360.3333

CALIFORNIA Sacramento
P 951.360.3500
F 951.360.3333

CONNECTICUT Bristol
P 866.921.0023
F 860.584.6899

FLORIDA Dade City
P 352.518.4400
F 352.518.4450

GEORGIA McDonough
P 678.304.5500
F 678.304.5555

HAWAII Kapolei
P 951.360.3500
F 951.360.3333

ILLINOIS Rochelle
P 800.659.0745
F 513.645.0750

KANSAS Lenexa
P 800.659.0745
F 513.645.0750

MARYLAND Baltimore
P 410.477.4000
F 410.477.1550

OHIO Warren-East
P 330.372.5564
F 330.372.4055

OHIO Warren-West
P 330.372.4014
F 330.372.1945

TEXAS Baytown
P 281.383.1617
F 281.573.1679

TEXAS Dallas
P 214.350.1716
F 214.350.7252

CLIP EXPRESSSM
P 866.638.1908
F 330.372.4055

VINYL CORP.TM
P 800.648.4695
F 305.477.4108

ClarkDietrich Engineering Services. A full spectrum of solutions.

Toll-Free Phone: 877.832.3206
Toll-Free Fax: 877.832.3208
Technical Services: 888.437.3244
Email: engineering@clarkdietrich.com

CENTRAL Crown Point, IN
NORTHEAST Bristol, CT
SOUTHEAST McDonough, GA

SOUTHEAST Roswell, GA
WEST Carlsbad, CA

Turn to ClarkDietrich for a complete lineup of steel construction products and services nationwide:

Interior Framing · Exterior Framing · Interior Finishing · Clips/Connectors · Metal Lath/Accessories · Engineering



9100 Centre Pointe Dr. Suite 210
West Chester, OH 45069

P 513.870.1100
F 513.870.1300

clarkdietrich.com
Clarkwestern Dietrich Building Systems LLC

CD-Full Line 5/12 © 5/12 ClarkDietrich Building Systems. The technical content of this literature is effective 5/31/12 and supersedes all previous information.