



Wet/Dry Vacuums

Operator's Manual



5 Gallon
Model No.
VOC507PF

FOR YOUR SAFETY

Read and understand this manual before use.
Keep this manual for future reference.



Distributed By
Cleva North America, Inc.
601 Regent Park Court
Greenville, SC 29607

Replacement Filters &
Accessories available at:
Vacmaster.com

TABLE OF CONTENTS

| SECTION | PAGE |
|---|------|
| Warranty | 2 |
| Safety Instructions & Warnings | 3 |
| Double Insulation Instructions | 4 |
| Extension Cords | 4 |
| Unpacking & Checking Carton Contents | 5 |
| General Assembly Instructions | 6 |
| Dry Vacuum Operation | 7 |
| Liquid Vacuum Operation | 8 |
| Blower Operation | 9 |
| Maintenance | 10 |
| Installing & Cleaning Reusable Cloth Filter | 11 |
| Installing & Cleaning Foam Wet Filter | 11 |
| Troubleshooting | 12 |
| Exploded View | 13 |
| Parts List | 14 |

Thank you for purchasing this Vacmaster® wet/dry vacuum cleaner. Feel confident that with Vacmaster® you are obtaining a high quality product engineered for optimal performance. This vacuum is capable of picking up liquids and dry materials.

FOR YOUR SAFETY: CAREFULLY READ AND UNDERSTAND ALL INSTRUCTIONS.

WARRANTY

We take pride in producing a high quality, durable product. This Vacmaster® product carries a limited two (2) year warranty against defects in workmanship and materials from date of purchase under normal household use. If product is to be used for commercial, industrial, or rental use, a 90 day limited warranty will apply. Please keep your receipt as proof of purchase. This warranty gives you specific legal rights, which may vary from state to state. For product service call Customer Service at 1-866-384-8432.

Not Covered by Warranty:

- Any part that has become inoperative due to misuse, negligence, direct/indirect abuse, accidents, improper maintenance, repairs, or alterations;
- Consumables such as filters and accessories;
- Normal wear and tear of parts and attachments, such as hose, nozzles, or casters;
- Normal deterioration of the exterior finish due to use or exposure;
- Any product where serial number/data label is tampered with or removed;
- Any product purchased from an unauthorized retailer.

SAFETY INSTRUCTIONS & WARNINGS

IMPORTANT SAFETY INSTRUCTIONS

READ AND UNDERSTAND ALL INSTRUCTIONS BEFORE USING THIS VACUUM.

Read and understand this operator's manual and all labels on the Wet/Dry Vacuum cleaner before operating. Safety is a combination of common sense, staying alert, and knowing how your vacuum works. Use this Wet/Dry Vac only as described in this manual. To reduce the risk of personal injury or damage to your Wet/Dry Vac, use only Vacmaster[®] recommended accessories.

Household Type

SAVE THIS MANUAL FOR FUTURE REFERENCE.

When using an electrical appliance, basic precautions should always be followed including the following:

WARNING: TO REDUCE THE RISK OF FIRE, ELECTRIC SHOCK, OR INJURY:

- Do not run vac unattended.
- Do not vacuum, or use this Wet/Dry Vac near flammable liquids, gases, or explosive vapors like gasoline or other fuels, lighter fluids, cleaners, oil-based paints, natural gas, hydrogen, or explosive dusts like coal dust, magnesium dust, grain dust, or gun powder. Sparks inside the motor can ignite flammable vapors or dust.
- Do not vacuum anything that is burning or smoking, such as cigarettes, matches, or hot ashes.
- Keep cord away from heated surfaces.
- Do not expose to rain. Store indoors.
- Do not unplug by pulling on cord. To unplug, grasp the plug, not the cord.
- Do not use with damaged cord, plug, or other parts.
- If appliance is not working as it should, has been dropped, damaged, left outdoors, or dropped into water, return it to a service center.
- Do not pull or carry by cord, use cord as handle, close a door on cord, or pull cord around sharp edges or corners.
- Do not run Wet/Dry Vac over cord.
- Do not handle plug or the Wet/Dry Vac with wet hands.
- To reduce the risk of health hazards from vapors or dusts, do not vacuum toxic materials.
- Do not use or store near hazardous materials.
- Do not use this Wet/Dry Vac with a torn filter or without the filter installed except when vacuuming liquids as described in the operation section of this manual.
- Do not allow to be used as a toy. Close attention is necessary when used by or near children.
- To reduce the risk of injury from accidental starting, unplug power cord before changing or cleaning filter.
- Do not leave Wet/Dry Vac unattended when plugged in. Unplug from outlet when not in use and before servicing.
- Turn off Wet/Dry Vac before unplugging.
- Do not put any object into ventilation openings. Do not vacuum with any ventilation openings blocked; keep free of dust, lint, hair, or anything that may reduce air flow.
- Keep hair, loose clothing, fingers, and all parts of body away from openings and moving parts.
- To reduce the risk of falls, use extra care when cleaning on stairs.
- Unplug before connecting hose.
- Use only as described in this manual. Use only manufacturer's recommended attachments.
- This appliance is provided with double insulation. Use only identical replacement parts. See "DOUBLE INSULATION INSTRUCTIONS".

When using as blower:

- Direct air discharge only at work area.
- Do not use Wet/Dry Vac as a sprayer.
- Do not direct air at bystanders.
- Keep children away when blowing.
- Use safety goggles.

DOUBLE INSULATION INSTRUCTIONS

This Wet/Dry Vac is double-insulated, eliminating the need for a separate grounding system. Use only identical replacements parts. Read the instructions for Servicing Double-Insulated Wet/Dry Vacs before servicing. Use this Wet/Dry Vac as described in this manual. Observe the following warnings that appear on the motor housing of your Wet/Dry Vac.



DOUBLE INSULATED - GROUNDING NOT REQUIRED - WHEN SERVICING USE ONLY IDENTICAL REPLACEMENT PARTS.

WARNING: TO REDUCE THE RISK OF ELECTRIC SHOCK, DO NOT EXPOSE TO RAIN. STORE INDOORS.

WARNING: SERVICING OF DOUBLE-INSULATED WET/DRY VACUUM
WITH A DOUBLE-INSULATED WET/DRY VACUUM, TWO SYSTEMS OF INSULATION ARE PROVIDED INSTEAD OF GROUNDING. NO GROUNDING MEANS IS PROVIDED ON A DOUBLE-INSULATED APPLIANCE, NOR SHOULD A MEANS FOR GROUNDING BE ADDED. SERVICING A DOUBLE INSULATED WET/DRY VACUUM REQUIRES EXTREME CARE AND KNOWLEDGE OF THE SYSTEM, AND SHOULD BE DONE ONLY BY QUALIFIED SERVICE PERSONNEL. REPLACEMENT PARTS FOR A DOUBLE-INSULATED WET/DRY VACUUM MUST BE IDENTICAL TO THE PARTS THEY REPLACE. YOUR DOUBLE-INSULATED WET/DRY VAC IS MARKED WITH THE WORDS 'DOUBLE INSULATED' AND THE SYMBOL  (SQUARE WITHIN A SQUARE) MAY ALSO BE MARKED ON THE APPLIANCE.

- To reduce the risk of electric shock, unplug before cleaning or servicing.
- DO NOT use without filters in place.

CAUTION: TO REDUCE THE RISK OF INJURY FROM MOVING PARTS, UNPLUG BEFORE SERVICING.

EXTENSION CORDS

When using an extension cord with your Wet/Dry Vac refer to the following table to determine the required A.W.G. wire size. Before using the vacuum cleaner, make sure the power cord and extension cord are in good working condition. Make repairs or replacements before using the vacuum cleaner. Only use extension cords that are rated for outdoor use.

| 110V-120V | Length of Extension Cord | | | |
|-----------|--------------------------|-------------------------|-------------------------|-------------------------|
| | 25 Feet 7.5 Meters | 50 Feet 15.25 Meters | 100 Feet 30.5 Meters | 150 Feet 45.7 Meters |
| Amps | A.W.G. Wire Size | | | |
| 0-6 | 18 | 16 | 16 | 14 |
| 7-10 | 18 | 16 | 14 | 12 |
| 11-12 | 16 | 16 | 14 | 12 |
| 13-16 | 14 | 12 | Not recommended | |

UNPACKING & CHECKING CARTON CONTENTS

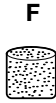
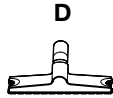
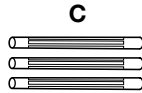
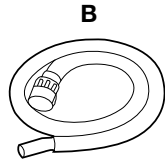
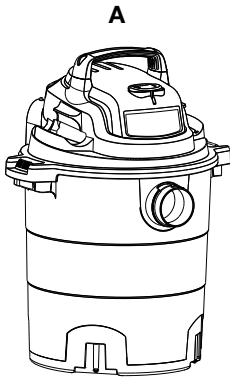

Remove all contents from the box. Remove the power head and take out any contents inside the collection tank. Check each item against the carton contents list.

Carton Contents List

| Key | Description | Qty. |
|-----|-----------------------|------|
| A | Vac Assembly | 1 |
| B | Hose | 1 |
| C | Extension Wand | 3 |
| D | Floor Nozzle | 1 |
| E | Reusable Cloth Filter | 1 |
| F | Foam Wet Filter | 1 |
| G | Caster Foot Assembly | 4 |
| H | 3 Screws (Bag) | 2 |
| I | Operator's Manual | 1 |
| J | Handle | 1 |

NOTE: The hose and accessories for this vacuum are 1.25" (3.2 cm) diameter.

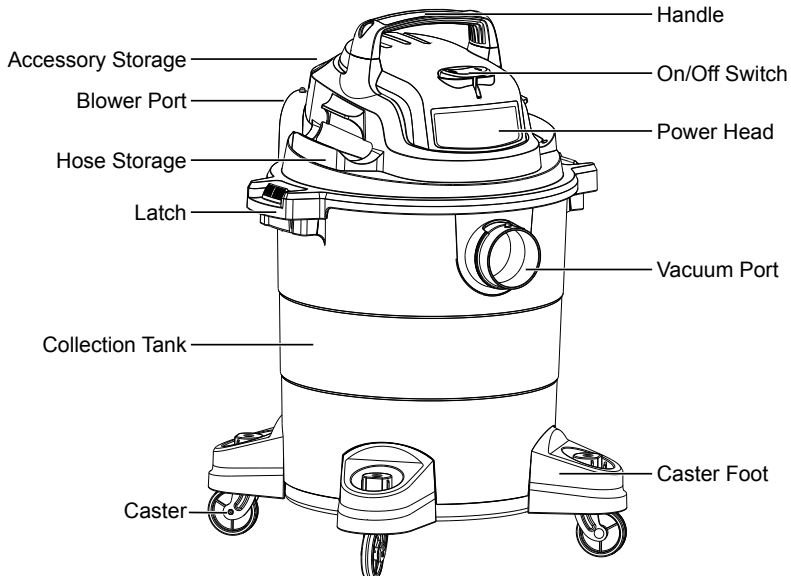

GENERAL ASSEMBLY INSTRUCTIONS

A Philips head screw driver is required.

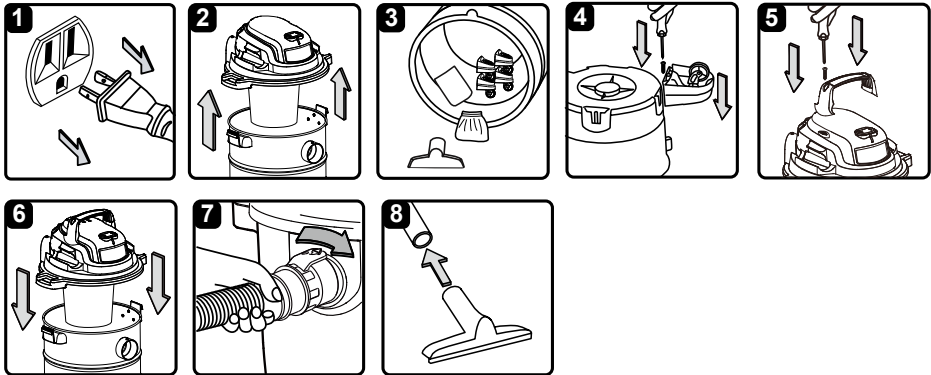

WARNING: TO REDUCE THE RISK OF ELECTRIC SHOCK, DO NOT EXPOSE TO RAIN. MAKE SURE PLUG IS DISCONNECTED BEFORE ASSEMBLING THE WET/DRY VAC.

UNPACKING YOUR WET/DRY VACUUM & GENERAL ASSEMBLY

1. Verify that the power cord is disconnected from the outlet. (Fig. 1)
2. Undo the latches and lift the power head off the collection tank. (Fig. 2)
3. Remove the contents from inside the collection tank; make sure you have all contents as listed on page 5. (Fig. 3)
4. Turn the collection tank upside down and insert the four caster feet into the slots on the collection tank and tighten with supplied screws. Verify that the casters are mounted correctly. Do not over-tighten screws. (Fig. 4)
5. Insert the handle into the slots located on the top of the power head and secure it with the screws provided. Do not over-tighten the screws. (Fig. 5)
6. Your vacuum comes ready for dry vacuum cleaning. For installation instructions, see page 11.
7. For wet vacuum cleaning, install the supplied foam wet filter. See page 11 for filter installation.
8. Place the power head back on the collection tank, and secure into place using the 2 side latches. (Fig. 6)
9. Insert the locking end of the hose into the port on the collection tank and turn clockwise to lock into place. (Fig. 7)
10. Choose the desired accessory and insert onto the end of the hose. (Fig. 8)

POLARIZED PLUG

To reduce the risk of electrical shock, this appliance has a polarized plug (one blade wider than the other). This plug will fit in a polarized outlet only one way. If the plug does not fit fully in the outlet, reverse the plug. If it still does not fit, contact a qualified electrician to install the proper outlet. Do not change the plug in any way. Double insulation eliminates the need for the three wire grounded power cord and grounded power supply system.

DRY VACUUM OPERATION

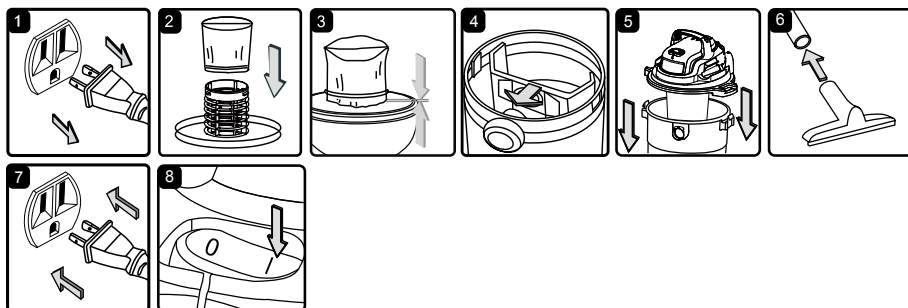

DRY VACUUMING

WARNING: BE SURE TO READ, UNDERSTAND, AND APPLY, INFORMATION ENTITLED 'SAFETY INSTRUCTIONS & WARNINGS'. DO NOT VACUUM IN AREAS WITH FLAMMABLE GASES, VAPORS, OR EXPLOSIVE DUSTS IN THE AIR. FLAMMABLE GASES OR VAPORS INCLUDE BUT ARE NOT LIMITED TO: LIGHTER FLUID, SOLVENT TYPE CLEANERS, OIL-BASED PAINTS, GASOLINE, ALCOHOL, OR AEROSOL SPRAYS. EXPLOSIVE DUSTS INCLUDE BUT ARE NOT LIMITED TO: COAL, MAGNESIUM, GRAIN, OR GUN POWDER. TO REDUCE THE RISK OF HEALTH HAZARDS FROM VAPORS OR DUST, DO NOT VACUUM TOXIC MATERIALS.

1. Verify that the power cord is disconnected from the outlet. (Fig. 1)
2. In order to prepare your vacuum for dry vacuuming, make sure the filter is completely covering the filter cage against the power head. (Fig. 2 & 3) Your Wet/Dry Vac comes with the filter pre-installed. For installation instructions, see page 11.
3. Optional: For improved dust filtering, fit collection bag flange onto inlet port, taking care not to damage the bag. Dust bag sold separately. (Fig. 4)
4. Place the power head section back on the collection tank and secure it in place using the latches. (Fig. 5)

OPERATING INSTRUCTIONS: DRY VACUUMING

5. Insert the locking end of the hose into the vacuum port on the power head and lock in place. Push the required attachment onto the free end of the hose or extension. (Fig. 6)
6. Plug the power cord into the outlet. (Fig. 7)
7. Turn the motor on by flipping the switch to the 'I' ON position. (Fig. 8)
8. Once you have completed vacuuming, flip the switch to the 'O' OFF position and unplug the power cord from the outlet.

DO NOT USE THE DUST FILTER FOR LIQUID VACUUMING.

O = OFF I = ON

LIQUID VACUUM OPERATION

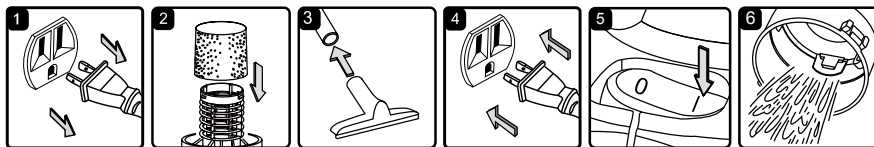

LIQUID VACUUMING

WARNING: BE SURE TO READ, UNDERSTAND, AND APPLY, INFORMATION ENTITLED 'SAFETY INSTRUCTIONS & WARNINGS'. DO NOT VACUUM IN AREAS WITH FLAMMABLE GASES, VAPORS, OR EXPLOSIVE DUSTS IN THE AIR. FLAMMABLE GASES OR VAPORS INCLUDE BUT ARE NOT LIMITED TO: LIGHTER FLUID, SOLVENT TYPE CLEANERS, OIL-BASED PAINTS, GASOLINE, ALCOHOL, OR AEROSOL SPRAYS. EXPLOSIVE DUSTS INCLUDE BUT ARE NOT LIMITED TO: COAL, MAGNESIUM, GRAIN, OR GUN POWDER. TO REDUCE THE RISK OF HEALTH HAZARDS FROM VAPORS OR DUST, DO NOT VACUUM TOXIC MATERIALS.

WARNING: DO NOT PLUG POWER CORD INTO POWER OUTLET. MAKE SURE PLUG IS DISCONNECTED BEFORE CHANGING THE FILTERS.

1. Verify that the power cord is disconnected from the outlet. (Fig. 1) Make sure that the collection tank is clean and free from dust and dirt.
2. Remove reusable cloth filter, then carefully install the foam wet filter over the filter cage and place the power head back on the collection tank. (Fig. 2) For filter installation instructions, see page 11.

DO NOT USE THE REUSABLE CLOTH FILTER FOR LIQUID VACUUMING.

OPERATING INSTRUCTIONS: WET VACUUMING

3. Fit the desired nozzle to the vacuum hose. (Fig. 3)
4. Verify that the switch is in the 'O' OFF position before plugging the power cord into the outlet. (Fig. 4)
5. Turn the motor on by pressing the switch to the 'I' ON position. (Fig. 5)
6. Once you have completed vacuuming, flip the switch to the 'O' OFF position and unplug the power cord from the outlet.
7. After use, empty the collection tank (Fig. 6), clean and dry the inside and outside before storage.

IMPORTANT! When vacuuming large quantities of liquids, do not immerse the nozzle completely in the liquid; leave a gap at the tip of the nozzle opening to allow air inflow. The machine is fitted with a float valve that stops the suction action when the collection tank reaches its maximum capacity. You will notice an increase in motor speed. When this happens, turn off the machine, disconnect from power supply, and drain the liquid into a suitable receptacle or drain. After wet vacuuming, turn the machine off and remove plug from power supply. Empty the collection tank, clean and dry the inside and outside before storage. **REMEMBER!** The foam wet filter must be removed after wet vacuuming, and a reusable cloth filter must be installed before dry vacuuming again.

BLOWER OPERATION

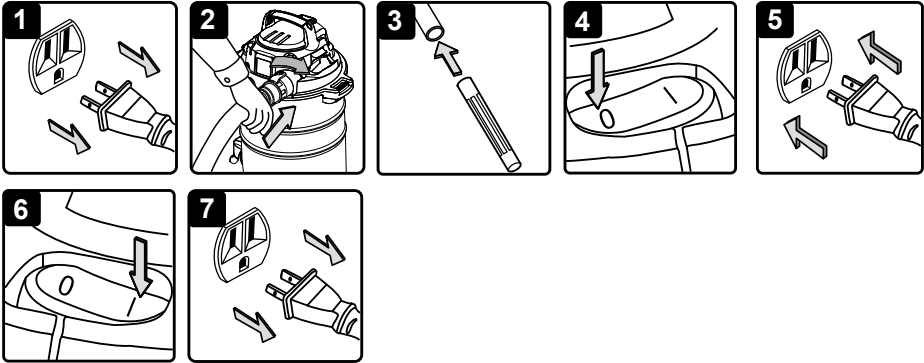

This Wet/Dry Vac has blowing capabilities. To use the blower feature follow the instructions listed.

WARNING: ALWAYS WEAR SAFETY GOGGLES COMPLYING WITH ANSI Z87.1 (OR IN CANADA, CSAZ94.3) BEFORE USING BLOWER.

CAUTION: KEEP BYSTANDERS CLEAR FROM BLOWING DEBRIS.

WARNING: WEAR A DUST MASK IF BLOWING CREATES DUST THAT MIGHT BE INHALED.

1. Verify that the power cord is disconnected from the outlet. (Fig. 1)
2. Make sure the collection tank is empty before using as a blower.
3. Remove hose from the vacuum port.
4. Insert the larger end of the hose into the blower port on the back side of the power head and lock into position. (Fig. 2)
5. Fit the desired attachment to the hose. (Fig. 3)
6. Verify that the power switch is in the 'O' (OFF) position before plugging the power cord into the outlet. (Fig. 4 & Fig. 5)
7. Before turning ON the vac, firmly hold the loose end of the hose. Turn the motor on by pressing the switch to the 'I' (ON) position. (Fig. 6)
8. Once you have completed vacuuming, flip the power switch to the 'O' (OFF) position and unplug the power cord from the outlet. (Fig. 7)

MAINTENANCE

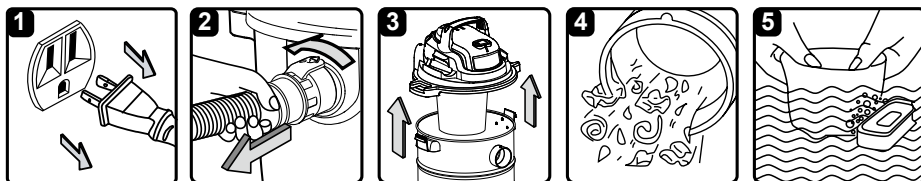

1. Verify that the power cord is disconnected from the outlet. (Fig. 1)
2. Disconnect the hose from the vacuum. (Fig. 2)
3. Undo the latches and remove the power head from the collection tank. (Fig. 3)
4. Clear all dirt or debris from the collection tank and hose. (Fig. 4)
5. Clean or replace the filters. (Fig. 5)
6. Check the hose, attachments, and power cord to verify that they have not been damaged.

IMPORTANT! Clean or change the filter regularly for best performance. **ALWAYS USE DUST FILTER FOR DRY VACUUMING.** If the machine is used without the dust filter, the motor will burn out and the warranty will be voided. Always keep spare dust filters on hand.

NOTICE! The filters included are made of high quality materials designed to stop small dust particles. The dust filter should be used for dry pick-up only. A dry dust filter is necessary to pick up dust. If the dust filter is wet, it will clog quickly and be difficult to clean. Handle the filter carefully when removing it for cleaning or replacing. Check the filters for tears or small holes. A small hole can let dust pass through and out of the filter. Do not use a filter with holes or tears in it; replace it immediately.

WARNING: ALWAYS DISCONNECT THE PLUG FROM THE POWER OUTLET BEFORE REMOVING THE POWER HEAD FROM COLLECTION TANK.

INSTALLING & CLEANING REUSABLE CLOTH FILTER

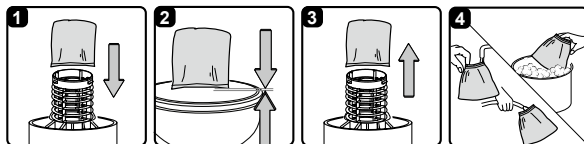

Installing Reusable Cloth Filter

1. Verify that the power cord is disconnected from the outlet.
2. Remove power head and place in upside down position.
3. Slide reusable cloth filter down over the filter cage making sure the cage is completely covered. (Fig. 1 & 2)
4. Place the power head back onto the collection tank.

Removing and Cleaning Reusable Cloth Filter

1. With the removed power head in an upside down position, carefully remove the reusable cloth filter from the filter cage. (Fig. 3) Clean the filter by gently tapping or brushing dirt off. Cleaning should not be done indoors in living areas.
2. Use a mild soap and water solution to wash reusable cloth filter and rinse with clean water. (Fig. 4)
3. Allow the wet filter to air dry for 24 hours before installing onto the filter cage.

INSTALLING & CLEANING FOAM WET FILTER

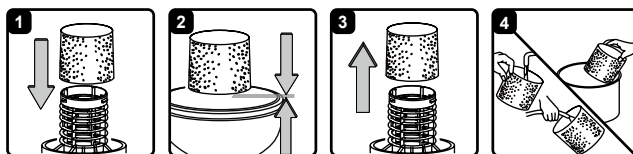

Installing Foam Wet Filter

1. Verify that the power cord is disconnected from the outlet.
2. Remove power head and place in upside down position. Follow instructions to remove cloth filter in the section above.
3. Carefully slide foam wet filter down over the filter cage making sure the whole cage is covered. (Fig. 1 & 2)
4. Replace the power head onto the collection tank.

Cleaning Foam Wet Filter

1. With the removed power head in an upside down position, carefully remove foam wet filter. (Fig. 3)
2. Use a mild soap and water solution to wash foam wet filter and rinse with clean water. (Fig. 4)
3. Allow filter to air dry before installing and using again.

TROUBLESHOOTING

WARNING: TO REDUCE THE RISK OF ELECTRIC SHOCK, UNPLUG BEFORE TROUBLESHOOTING

| Symptom | Possible Causes | Corrective Action |
|---|--|--|
| Vacuum will not operate. | 1) No power supply. | 1) Check power supply – cord, breakers, fuses. |
| | 2) Faulty power cord. | 2) Unplug and check the power cord. If damaged, have it repaired by a professional. |
| | 3) Collection tank full. | 3) Empty collection tank. |
| Dust comes from motor cover. | 1) The dust filter is missing or damaged. | 1) Attach or replace dust filter. |
| | 2) Vacuum has been used to collect fine dust, such as drywall dust, fireplace soot, or ash, without a fine dust filter equipped. | 2) Remove the standard cloth filter and install the appropriate fine dust cartridge filter. |
| Reduced efficiency and motor/speed vibration. | 1) There is a blockage in the nozzle or hose, or the collection tank inlet. Or dust filter blocked by fine dust. | 1) Check nozzle, hose and collection tank inlets for blockage. Take off the filter and clean it or install a new filter. |

EXPLODED VIEW

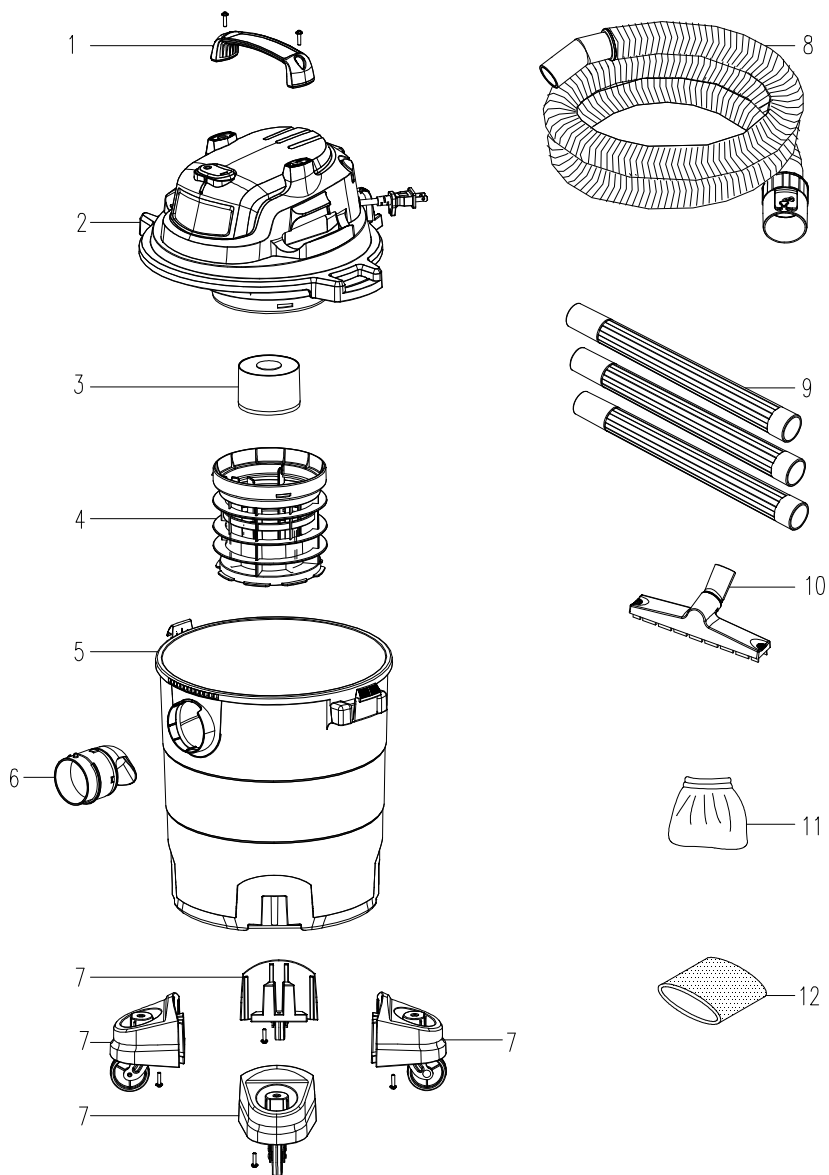

PARTS LIST

| Part | Drawing Number | Description | Quantity |
|------|----------------|-----------------------|----------|
| 1 | 551246001 | Handle Assembly | 1 |
| 2 | | Power Head Assembly | 1 |
| 3 | 551005103 | Float Cup | 1 |
| 4 | 551005104 | Filter Cage | 1 |
| 5 | | Collection Tank | 1 |
| 6 | 551011106 | Vacuum Port Assembly | 1 |
| 7 | 551058106 | Caster Foot Assembly | 4 |
| 8 | 551003108 | Hose | 1 |
| 9 | 551003109 | Extension Wands | 3 |
| 10 | 551003111 | Floor Nozzle | 1 |
| 11 | 551003104 | Resuable Cloth Filter | 1 |
| 12 | 551002118 | Foam Wet Filter | 1 |