

Installation Guide

for EMCO® Woodcore Self-Storing Crossbuck, Traditional Triple-Track and Colonial Triple-Track Storm Doors



Please Do Not Return Product to Store!

PLEASE call the storm door Solution Center at 1-800-933-3626, with any questions regarding installation, lost part replacement, or anything else related to your storm door purchase.

Read this entire guide before you begin your installation. If your abilities do not match the requirements of this installation, contact an experienced contractor.



PARTS OVERVIEW

Your installation kit should contain the following parts. However, in some door models, not all of the parts will be used.

- A** Rain Cap
- B** Door Frame
- C** Ventilating Glass Panel
(2 for Triple-Track Doors,
1 for Self-Storing Doors)
- D** Hinge Rail with 4 hinges
(Hinge Side Z-bar)
- E** Insect Screen
- F** Latch Rail
(Handle Side Z-bar)
- G** Sweep (Vinyl)
- H** Sweep (Metal)
- I** Sweep Fin
(For Metal Sweeps)
- J** Hinge Rail Shim
- K** Rain Cap Extender

Not Shown

- L** Installation Kit
(Pink, Clear & Green
Parts Bags Inside)
- M** Latch Side Spacer Clip
- N** Sill Spacer Clip
- O** Ventilating Glass Panel
Latches

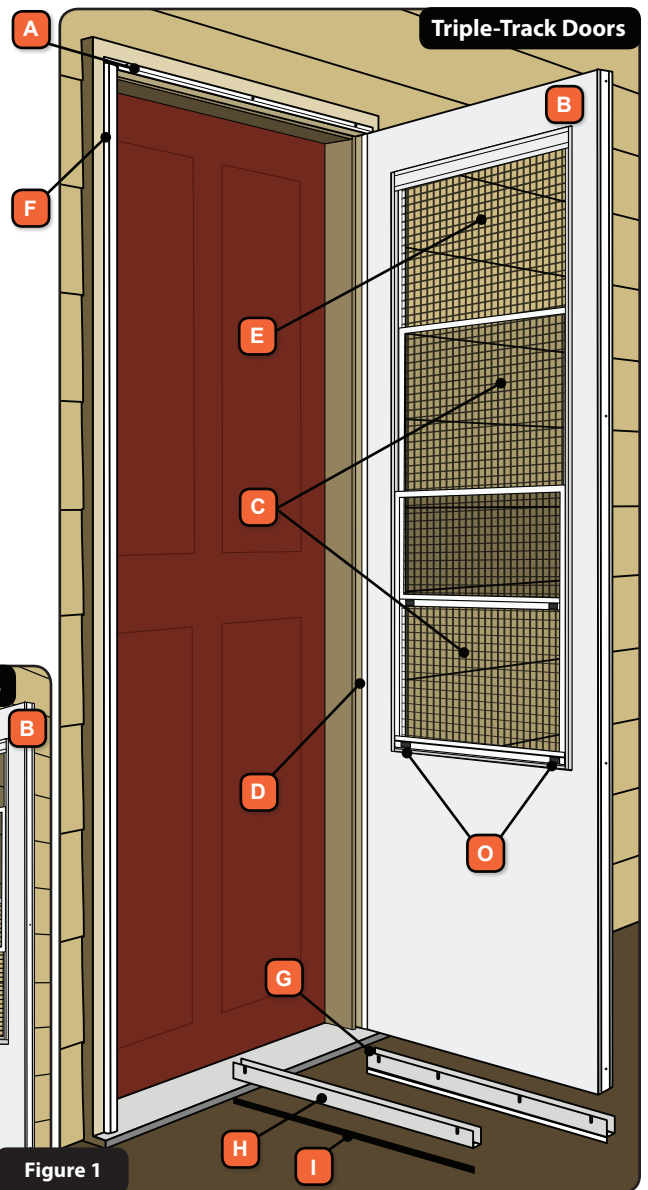
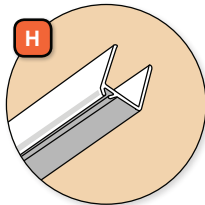
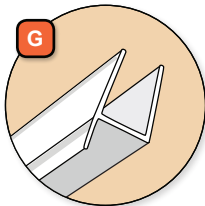
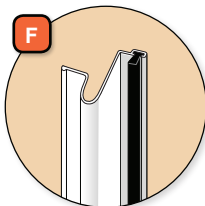
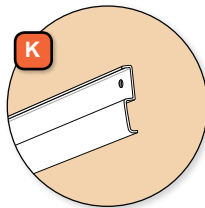
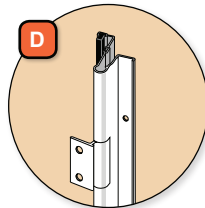
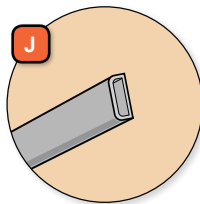
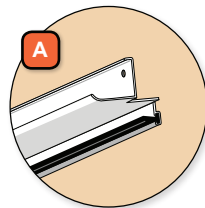

Figure 1

EMCO®

EMCO Enterprises, Inc., is a wholly owned subsidiary of Andersen Corporation. EMCO manufactures and supports the limited warranties for Andersen® and EMCO® doors. "Andersen", "EMCO" and all other marks where denoted are trademarks of Andersen Corporation. ©2014 Andersen Corporation. All rights reserved.

Andersen SDD, PO Box 853
Des Moines, IA 50306-0853
Rev 1-2014 12088 Print in Color

p/n 504117

SAFETY FIRST: Please read and follow all Cautions and Warnings in this guide.

WARNING
Entry door hardware and handle may become hot when exposed to sunlight.

WARNING
Metal fasteners and other hardware components may corrode when exposed to preservative treated and fire-retardant treated lumber. Obtain and use the appropriate size stainless steel fasteners and hardware as called out by the installation guide to fasten unit to any rough opening made from pressure treated and fire-retardant treated lumber. Failure to use the appropriate materials for the installation may cause a failure resulting in injury, property or product damage.

WARNING
Improper use of hand or power tools could result in injury and/or product damage. Follow equipment manufacturer's instructions for safe operation. Always wear safety glasses.

WARNING
Windows and doors can be heavy. Use safe lifting techniques and a reasonable number of people with enough strength to lift, carry, and install window and door products to avoid injury and/or property damage.

WARNING
The insect screen is intended for reasonable insect control and not the retention of objects or persons within the interior. The insect screen material will not stop a person from falling through the door.

RECOMMENDED TOOLS

Drill Bits

Lever & Knob Handle Set: **3/32"**
7/16"
5/8"

Push Button Handle Set: **3/32"**
5/16"

Safety Glasses

Screwdriver

Gloves

Pliers

Scissors

Pencil

Drill

Hammer

Tape Measure

Center Punch

1 VERIFY MOUNTING REQUIREMENTS

Verify that the exterior brick mold, trim board or casing is firmly attached to the opening. The storm door will sag over time if the mounting surface is not sufficiently fastened to the entryway.

To install the storm door, you must verify that the opening width, height and mounting surface are sufficient.

1. Measure the width at the top, middle, and bottom of the opening (Figure 2). Measure from the inside of the brick mold or exterior trim. Refer to Table 1.
2. Measure the height at the center of the opening. Measure from the inside of the brick mold or exterior trim, down to the top of the bottom sill. Refer to Table 1.

| Nominal Storm Door Sizes ** | Opening Sizes | |
|-----------------------------|--------------------|------------|
| | W 1 - 3 (width) * | H (height) |
| 36" x 80" | 35 3/4" TO 36 3/8" | 80" TO 81" |
| 34" x 80" | 33 3/4" TO 34 3/8" | |
| 33" x 80" | 32 3/4" TO 33 3/8" | |
| 32" x 80" | 31 3/4" TO 32 3/8" | |
| 30" x 80" | 29 3/4" TO 30 3/8" | |
| 36" x 78" | 35 3/4" TO 36 3/8" | 78" to 79" |
| 32" x 78" | 31 3/4" TO 32 3/8" | |
| 30" x 78" | 29 3/4" TO 30 3/8" | |

Table 1:
Use this table to determine if your storm door will fit into the opening:

3. Make sure that the brick mold or exterior trim meets the mounting surface requirements to install the rain cap, hinge rail and latch rail (Figure 3). You must have a minimum of:
 - 1" mounting surface depth. *
 - 3/4" mounting surface front. *
 - 2 1/2" handle clearance
- * For opening widths up to 1" wider or for mounting surface depth between 5/8" - 3/4", please call our Solution Center at 1-800-933-3626 to purchase a special kit to accommodate your situation.
- ** Nominal storm doors sizes are listed. The actual storm door frame width and height will be less. Example: A nominal size of 36" x 80" may have an actual storm door frame size of 35 1/8" x 79 1/8".

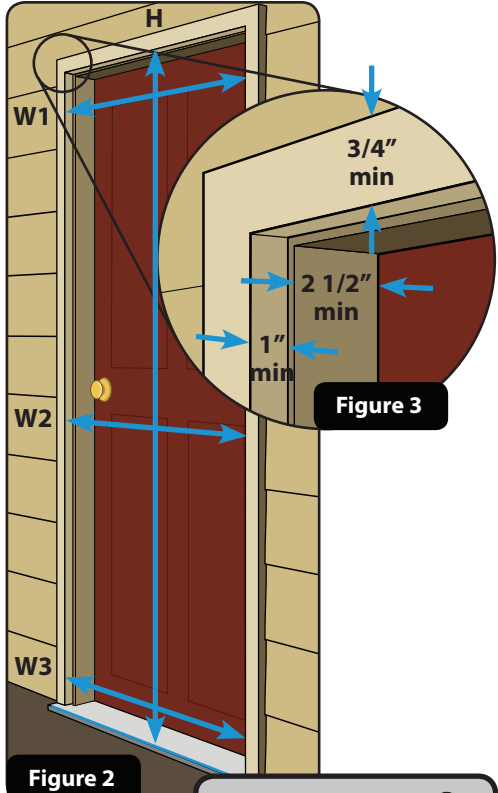

INTERIOR VIEW
VISTA INTERIOR = VIEW
VUE DE L'INTÉRIEUR

EXTERIOR VIEW
VISTA EXTERIOR = VIEW
VUE DE L'EXTÉRIEUR

2

INSTALLATION PREPARATION

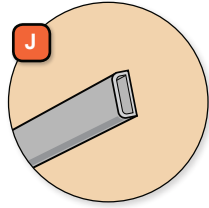

Tools needed:

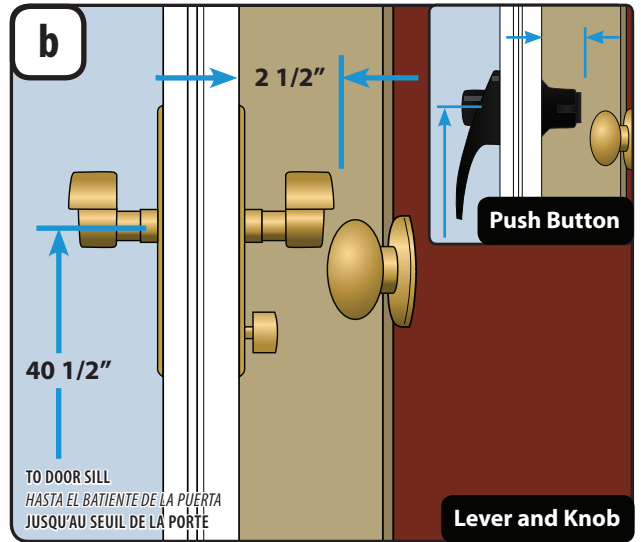
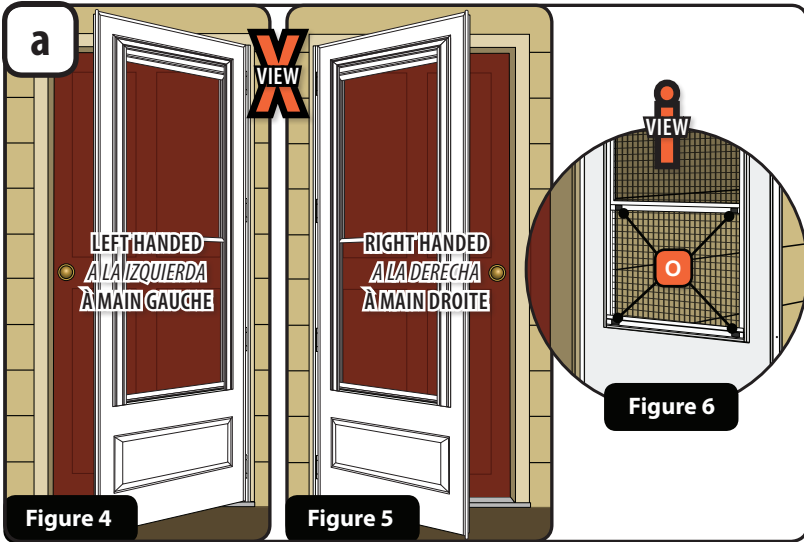
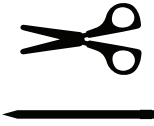

In this step, you will determine the handle side of your storm door.

1. Left Handed (Figure 4): From the exterior, a left handed storm door will have the handle on the left side of the storm door. See pages 4-6 for installation instructions.
2. Right Handed (Figure 5): From the exterior, a right handed storm door will have the handle on the right side of the storm door. See pages 7-9 for installation instructions.
3. The interior side is where ventilating glass panel latches are located. (Figure 6).

1. Most homeowners prefer to have the storm door handle on the same side as the entry door handle. In shallow door openings, this can cause the two handles to interfere. Check for potential interference using the rough measurements. If you anticipate that there will be interference, hand the storm door on the opposite side of your entry door. See page 2, Figure 3 for detailed hardware depth requirements.

c Determine if Hinge Rail Shim is needed

| Nominal Storm Door Sizes | Shim needed if opening width is: |
|--------------------------|----------------------------------|
| 36" x 80" / 36" x 78" | 36 1/8" TO 36 3/8" |
| 34" x 80" | 34 1/8" TO 34 3/8" |
| 33" x 80" | 33 1/8" TO 33 3/8" |
| 32" x 80" / 32" x 78" | 32 1/8" TO 32 3/8" |
| 30" x 80" / 30" x 78" | 30 1/8" TO 30 3/8" |

IF REQUIRED
SI FUERA NECESARIO
SI NÉCESSAIRE

Tape x 4

1. Use the table above to determine if you need to use the provided hinge rail shim (J).
2. If your opening width falls within the dimensions listed, you will need to install the shim. (If installing a 78" tall storm door, first cut off 2" from one end of the shim.) If your opening width does not fall within these dimensions, proceed to **step 3**.
3. Remove any debris from the mounting surface where the hinge rail shim will be attached.
4. Apply the four strips of double stick tape from the pink bag to the shim, spacing them evenly along the entire length. Attach the shim to the mounting surface, as shown.

3

**PREPARE
STORM
DOOR FOR
INSTALLATION
(Left Hand)**

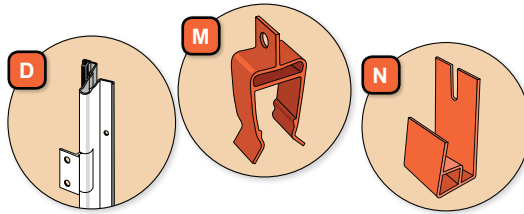

Tools needed:



PINK BAG // BOLSA ROSA // SAC ROSE

| | | | |
|---|--------------|--|------------------|
| L | 1/2" Painted | | x 2 or x 4 |
| | 1" | | x 8 |
| | 1/8" | | |

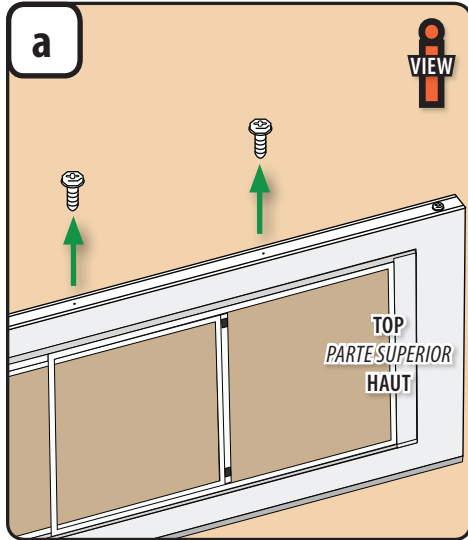

1. Place the latch side edge of door frame on the ground. TIP: Lay on door carton.
2. Identify the top of the hinge rail (D).
3. Remove the two middle hex head screws from the hinge side edge of door frame and properly discard.

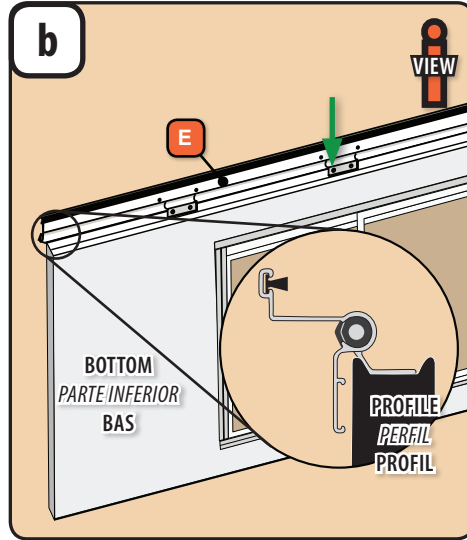

1. Position the hinge rail along the hinge-side edge of the door frame so the bottom hole of the 2nd hinge up from the bottom lines up with the bottom hole from the screw removed in **step 3a**. **NOTE:** The top of the hinge rail should extend approximately 3/16" beyond the top of the door frame.
2. Pre-drill 1" deep pilot holes in door frame at each hinge and fasten using 1" unpainted screws from the pink bag in the installation kit.

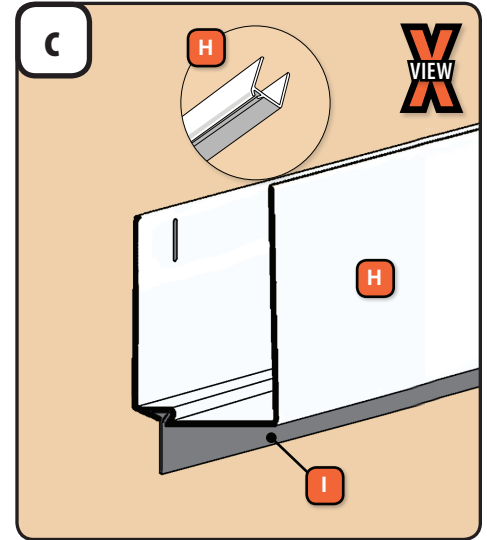

1. **Sweep H only:** Slide the sweep fin (I) into the track in the sweep. Crimp both ends of the track to secure the fin. Trim off excess sweep fin material and properly discard.

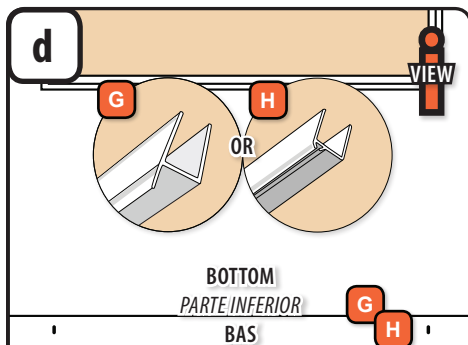

CAUTION

Do not drill completely through door. This will create an unnecessary hole in the door and may cause water and air infiltration.

1. Install the door sweep (G/H) so that it is centered across the width of the door frame and pressed tight against the bottom of the door frame. Doors with vinyl sweeps were shipped with the sweep on the side of the door frame.
2. Center punch and then predrill 1/8" pilot holes at the bottom of the slot for future adjustment, then attach the sweep using painted 1/2" screws from the pink bag.

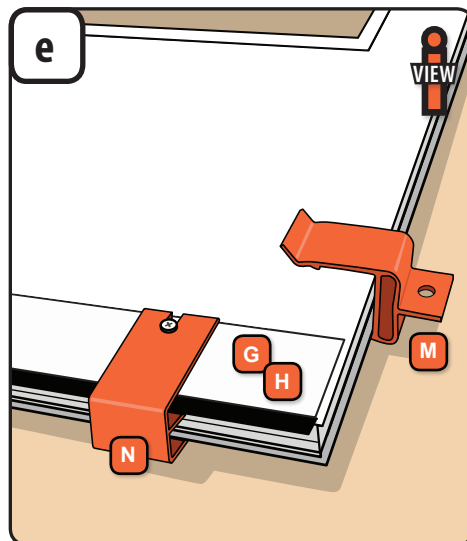

1. Install the sill spacer clip (N) under the latch side sweep screw and tight against the bottom of the sweep (G/H). Tighten the sweep screw to retain the sill spacer clip in place.
2. Install the latch side spacer clip (M) over the latch side of the door frame as shown. This clip should be approximately 6" from the bottom of the door frame.

4

INSTALL HINGED STORM DOOR IN OPENING (Left Hand)

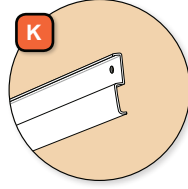
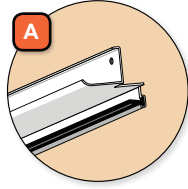

Tools needed:

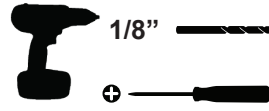

YELLOW BAG // BOLSA AMARILLA // SAC JAUNE

- L** 1" x 8 screws
- 1" x 11 screws
- 3/16" Plug x 1



1. Set the door frame on the entry sill so the hinge rail is tight against the mounting surface (or hinge rail shim) and the sill spacer clip is sitting on the door sill.
2. Tip the top of the door frame into the opening, making sure that the sill spacer clip (N) is still on the door frame and resting on the sill.

NOTE: Door may be out of square at this time.

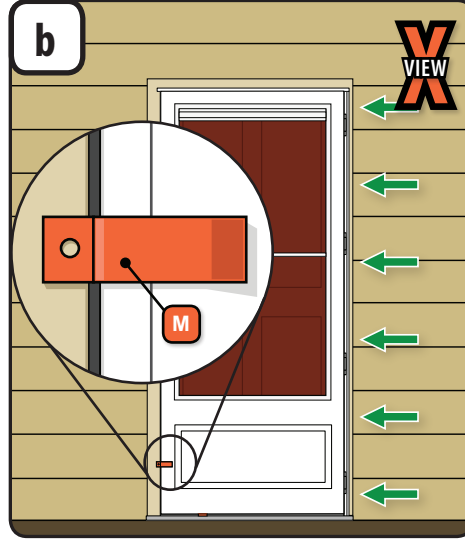

1. The door frame is properly seated in the opening when the hinge rail and latch side spacer clip (M) are flush against the mounting surface and the mounting surface completely fills the hole in the latch side spacer clip. If the latch side spacer clip hole is not completely filled, review **step 2c**.
2. Using the drill bit and 1" screws from the yellow bag in the installation kit, fasten the hinge rail to the mounting surface.

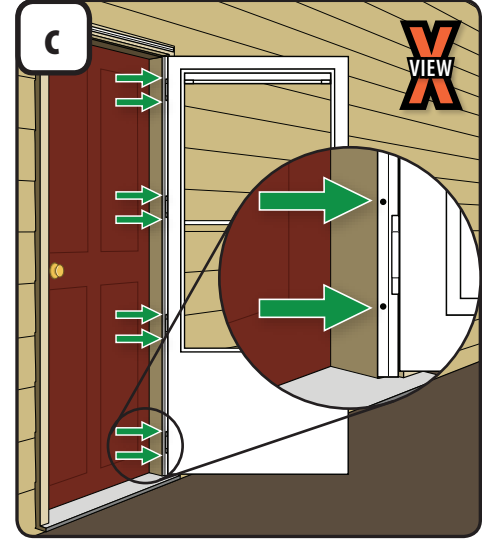

1. Open the storm door.
2. Pre-drill and fasten the hinge rail to the door jamb using 1" unpainted screws from the yellow bag.
3. Remove both orange clips from the bottom of the door frame and properly discard.

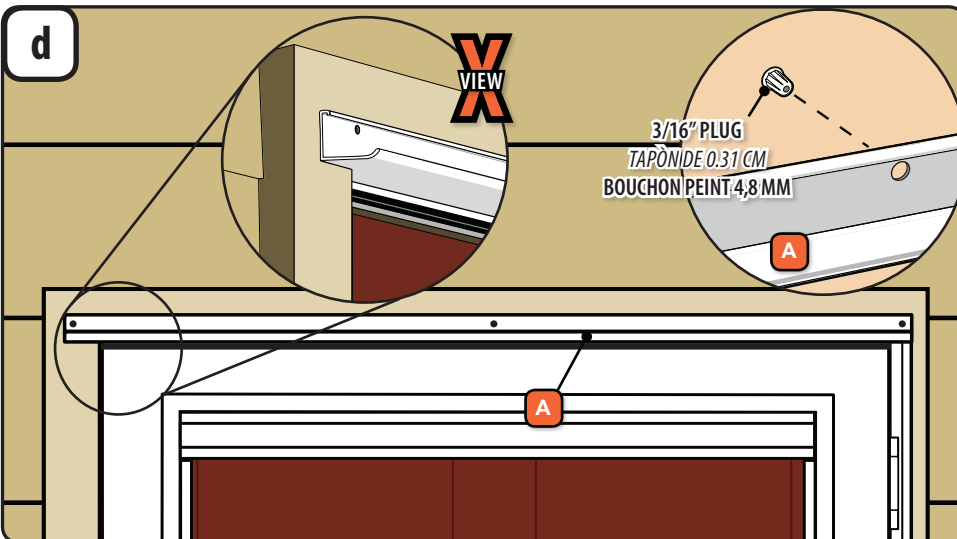

1. Open the storm door. Place the rain cap (A) in the opening so that it rests on top of the hinge rail, aligning the end of the the rain cap with the edge of the hinge rail.
2. Close the storm door. Adjust rain cap to achieve an even gap between the top of the door frame.
3. Look at the center hole of the rain cap. If the mounting surface can be seen in the entire hole, proceed to **step 4e**. If the mounting surface cannot be seen in the entire hole, or if there is space above the rain cap, then remove the rain cap.
4. From the mounting surface (back) side of the rain cap, completely insert a 3/16" plug from the yellow bag into the middle hole.
5. Re-install the rain cap as described above.

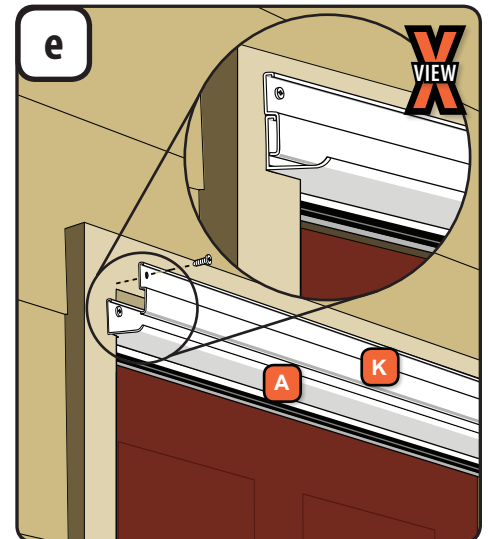

1. Using the drill bit and 1" painted screws from the yellow bag, fasten the rain cap to the mounting surface.
2. If a plug was installed in the middle hole, you will need to install the rain cap extender (K).
3. Place the rain cap extender over the rain cap as shown, with both ends being flush.
4. Using the drill bit and 1" painted screws from the yellow bag in the installation kit, fasten the rain cap extender to the mounting surface.

5 INSTALL LATCH RAIL (Left Hand)

Tools needed:

YELLOW BAG / BOLSA AMARILLA / SAC JAUNE

1" x 6 screws

Pad x 3

1/8" drill bit

6 INSTALL HANDLE SET (Left Hand)

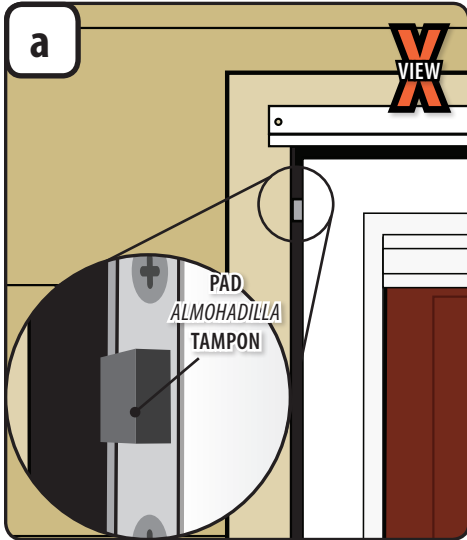

1. Find the three 1/2" square adhesive backed spacer pads in yellow bag in installation kit.
2. Swing door open and wipe off any residue on edge of door.
3. Peel paper backer off each pad and attach them to latch side door edge. Position one approximately 6" down from top of door, another close to center of door, and the third approximately 6" up from bottom.

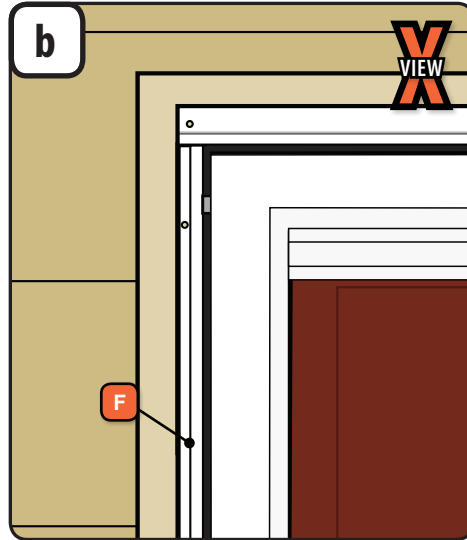

1. Place latch rail (F) in the opening with top end pushed up against rain cap.
2. Close storm door and slide latch rail towards door frame until it contacts all three spacer pads, creating 3/16" gap.
3. Using drill bit and 1" screws from yellow bag, fasten latch rail to mounting surface.
4. Open storm door and remove spacer pads, then properly discard.

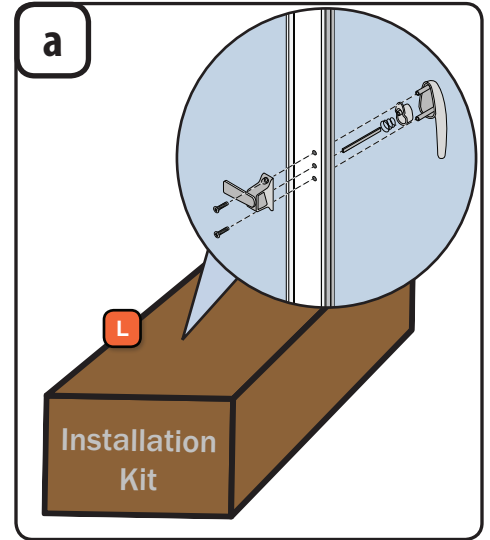

1. Refer to the instructions included in the Installation Kit (L) to install the door handles.

7 INSTALL CLOSER (Left Hand)

8 ADJUST SWEEP (Left Hand) (If necessary)

Tools needed:

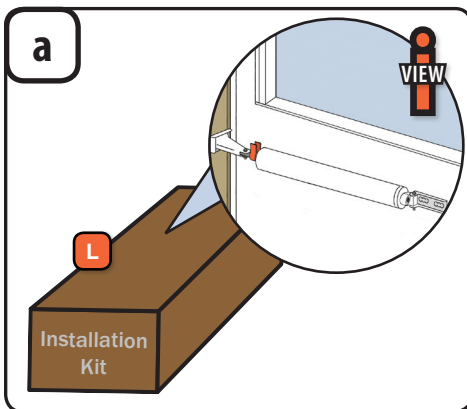

1. Refer to the instructions included in the Installation Kit to install the closer.

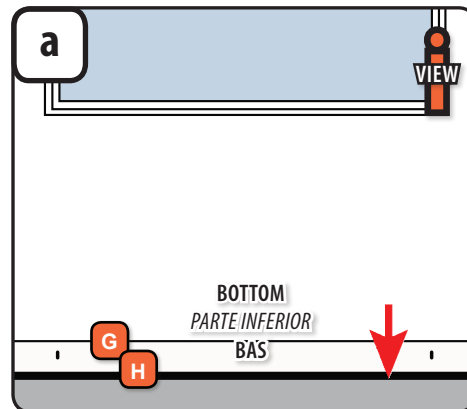

1. Close the storm door.
2. From the interior, loosen the sweep screws with a phillips screw driver. Adjust the sweep (G/H) up or down until the sweep fin lightly comes into contact with the door sill.
3. Retighten the sweep screws.

9

**PREPARE
STORM
DOOR FOR
INSTALLATION
(Right Hand)**

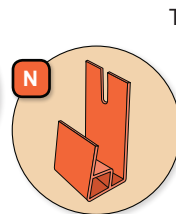
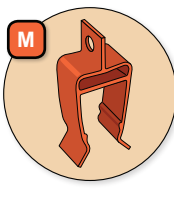
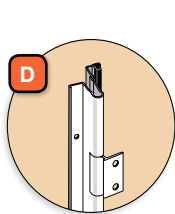

Tools needed:



PINK BAG // BOLSA ROSA // SAC ROSE

| | |
|----------------|------------|
| 1/2" Painted | X 2 or X 4 |
| 1" Unpainted | X 8 |
| 1/8" Pilot Bit | |

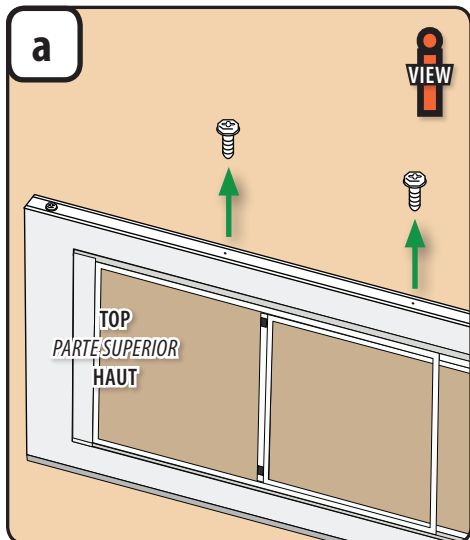

1. Place the latch side edge of door frame on the ground. TIP: Lay on door carton.
2. Identify the top of the hinge rail (D).
3. Remove the two middle hex head screws from the hinge side edge of door frame and properly discard.

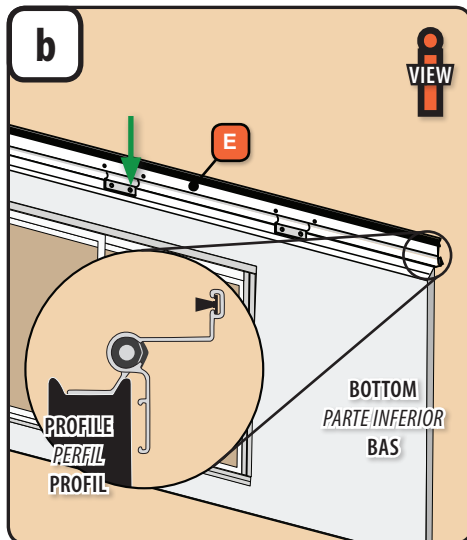

1. Position the hinge rail along the hinge-side edge of the door frame so the bottom hole of the 2nd hinge up from the bottom lines up with the bottom hole from the screw removed in **step 7a**. **NOTE:** The top of the hinge rail should extend approximately 3/16" beyond the top of the door frame.
2. Pre-drill 1" deep pilot holes in door frame at each hinge and fasten using 1" unpainted screws from the pink bag in the installation kit.

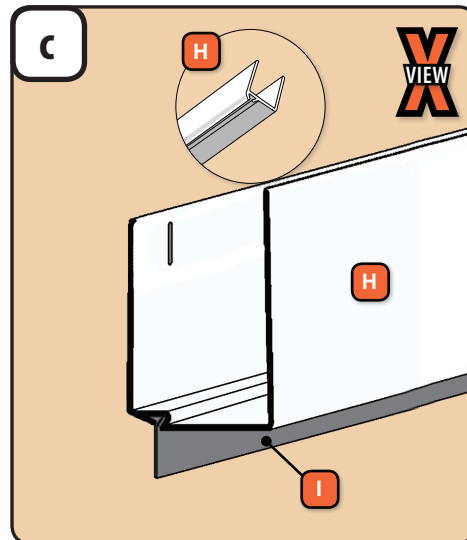

1. **Sweep H only:** Slide the sweep fin (I) into the track in the sweep. Crimp both ends of the track to secure the fin. Trim off excess sweep fin material and properly discard.

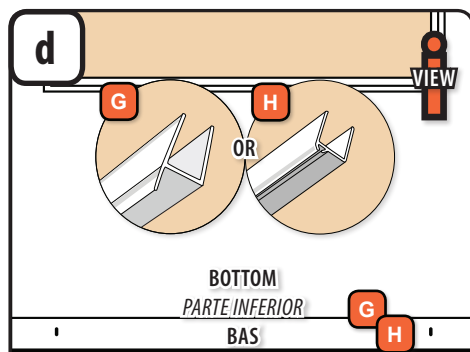

CAUTION

Do not drill completely through door. This will create an unnecessary hole in the door and may cause water and air infiltration.

1. Install the door sweep (G/H) so that it is centered across the width of the door frame and pressed tight against the bottom of the door frame. Doors with vinyl sweeps were shipped with the sweep on the side of the door frame.
2. Center punch and then predrill 1/8" pilot holes at the bottom of the slot for future adjustment, then attach the sweep using painted 1/2" screws from the pink bag.

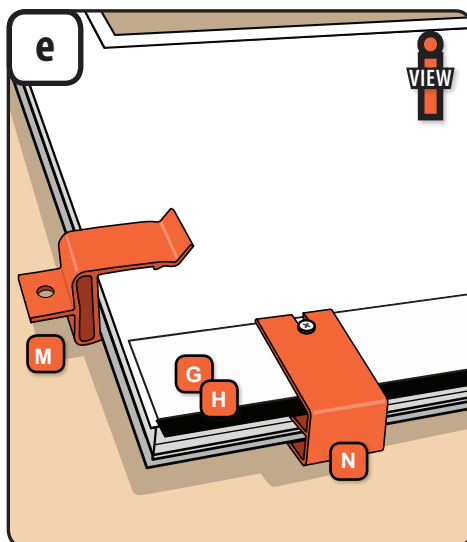

1. Install the sill spacer clip (N) under the latch side sweep screw and tight against the bottom of the sweep (G/H). Tighten the sweep screw to retain the sill spacer clip in place.
2. Install the latch side spacer clip (M) over the latch side of the door frame as shown. This clip should be approximately 6" from the bottom of the door frame.

10

**INSTALL
HINGED
STORM DOOR
IN OPENING
(Right Hand)**

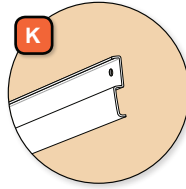
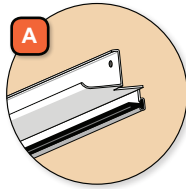

Tools needed:

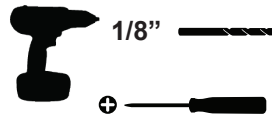

YELLOW BAG / BOLSA AMARILLA / SAC JAUNE

- L** 1" x 8 screws x 8
- 1" x 11 screws x 11
- 3/16" Plug x 1

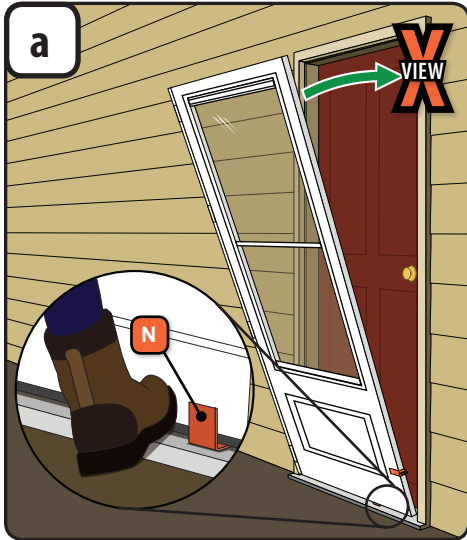

1. Set the door frame on the entry sill so the hinge rail is tight against the mounting surface (or hinge rail shim) and the sill spacer clip is sitting on the door sill.
2. Tip the top of the door frame into the opening, making sure that the sill spacer clip (N) is still on the door frame and resting on the sill.

NOTE: Door may be out of square at this time.

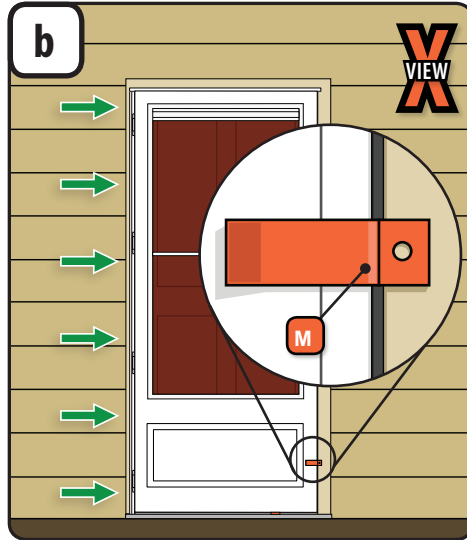

1. The door frame is properly seated in the opening when the hinge rail and latch side spacer clip (M) are flush against the mounting surface and the mounting surface completely fills the hole in the latch side spacer clip. If the latch side spacer clip hole is not completely filled, review **step 2c**.
2. Using the drill bit and 1" screws from the yellow bag in the installation kit, fasten the hinge rail to the mounting surface.

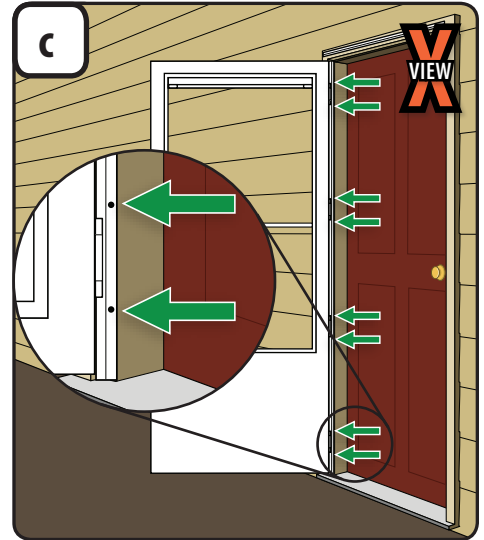

1. Open the storm door.
2. Pre-drill and fasten the hinge rail to the door jamb using 1" unpainted screws from the yellow bag.
3. Remove both orange clips from the bottom of the door frame and properly discard.

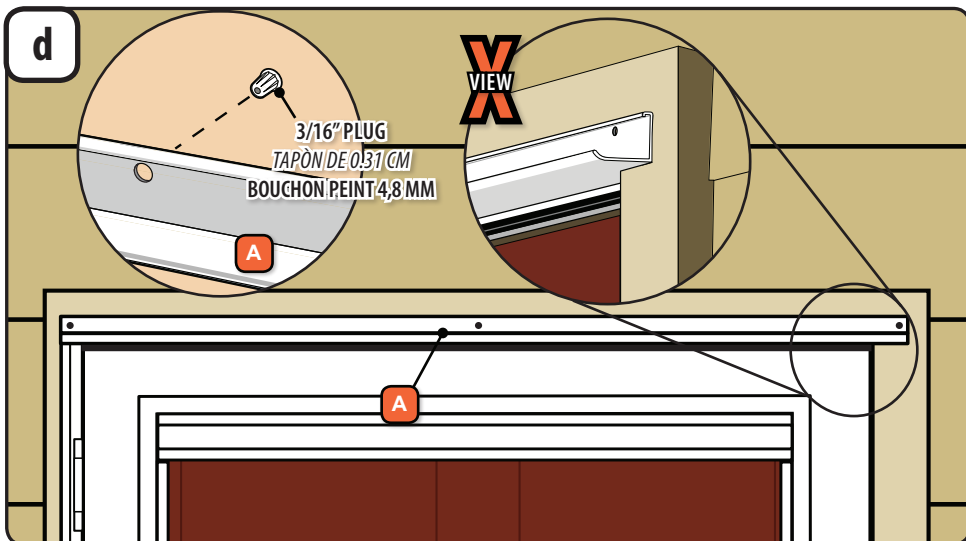

1. Open the storm door. Place the rain cap (A) in the opening so that it rests on top of the hinge rail, aligning the end of the the rain cap with the edge of the hinge rail.
2. Close the storm door. Adjust rain cap to achieve an even gap between the top of the door frame.
3. Look at the center hole of the rain cap. If the mounting surface can be seen in the entire hole, proceed to **step 10e**. If the mounting surface cannot be seen in the entire hole, or if there is space above the rain cap, then remove the rain cap.
4. From the mounting surface (back) side of the rain cap, completely insert a 3/16" plug from the yellow bag into the middle hole.
5. Re-install the rain cap as described above.

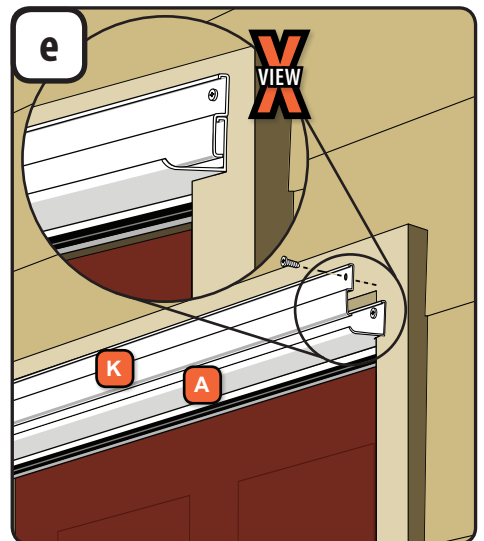

1. Using the drill bit and 1" painted screws from the yellow bag, fasten the rain cap to the mounting surface.
2. If a plug was installed in the middle hole, you will need to install the rain cap extender (K).
3. Place the rain cap extender over the rain cap as shown, with both ends being flush.
4. Using the drill bit and 1" painted screws from the yellow bag in the installation kit, fasten the rain cap extender to the mounting surface.

11

INSTALL LATCH RAIL (Right Hand)

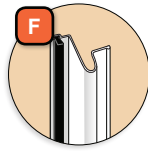

Tools needed:

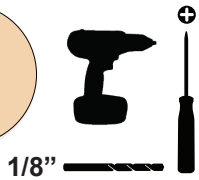

YELLOW BAG / BOLSA AMARILLA / SAC JAUNE

1" x 6

Pad x 3

12

INSTALL HANDLE SET (Right Hand)

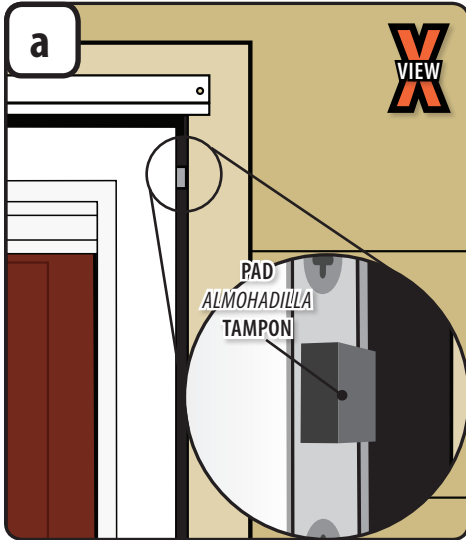

1. Find the three 1/2" square adhesive backed spacer pads in yellow bag in installation kit.
2. Swing door open and wipe off any residue on edge of door.
3. Peel paper backer off each pad and attach them to latch side door edge. Position one approximately 6" down from top of door, another close to center of door, and the third approximately 6" up from bottom.

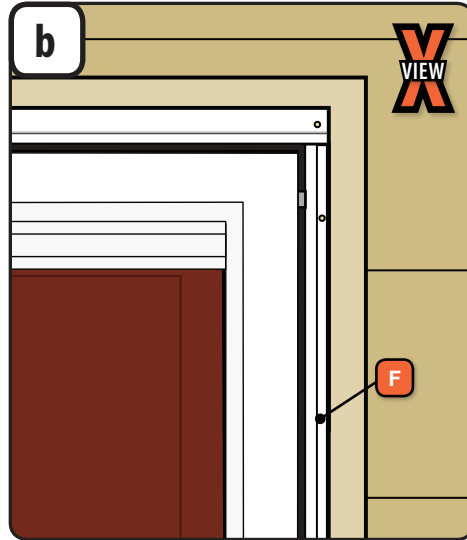

1. Place latch rail (F) in the opening with top end pushed up against rain cap.
2. Close storm door and slide latch rail towards door frame until it contacts all three spacer pads, creating 3/16" gap.
3. Using drill bit and 1" painted screws from yellow bag, fasten latch rail to mounting surface.
4. Open storm door and remove spacer pads, then properly discard.

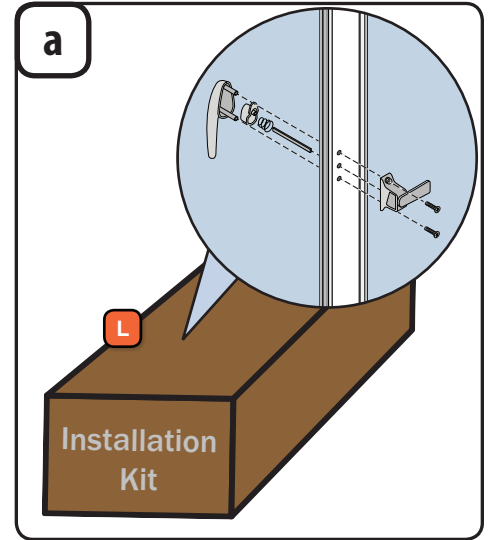

1. Refer to the instructions included in the Installation Kit (L) to install the door handles.

13

INSTALL CLOSER (Right Hand)

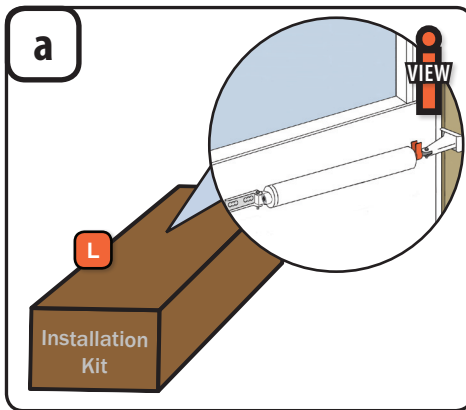

1. Refer to the instructions included in the Installation Kit to install the closer.

14

ADJUST SWEEP (Right Hand) (If necessary)

Tools needed:

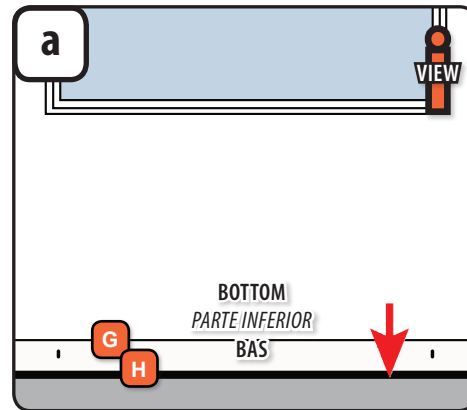
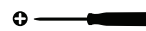

1. Close the storm door.
2. From the interior, loosen the sweep screws with a phillips screw driver. Adjust the sweep (G/H) up or down until the sweep fin lightly comes into contact with the door sill.
3. Retighten the sweep screws.

CLEANING INSTRUCTIONS

WINDOW GLASS – The glass may be cleaned with any household glass cleaner. Keep glass cleaners away from painted parts and brass/nickel components.

PLASTIC PARTS – Plastic door components may be cleaned using a mild soap and water mixture and by gently rubbing the affected area. Do not use harsh abrasives or any product that contains chlorine.

ALUMINUM PARTS – Aluminum parts on the door may be cleaned using a mild soap and water mixture and by gently rubbing the affected area. Mineral spirits may be used and will not harm the paint. This will remove many items such as glue residue. Do not use harsh abrasives or any product that contains chlorine.

LIMITED WARRANTIES

PRODUCT LIMITED WARRANTY

DOOR FRAME: EMCO Enterprises, Inc. (EMCO) warrants the door frame, hinges, and painted finish on EMCO® storm door products to be free from defects in manufacturing, materials, paint adhesion, or workmanship, under normal use, for ten (10) years or as long as the original consumer purchaser owns the home in which the door was initially installed, whichever is shorter.

COMPONENTS: EMCO warrants the non-glass and non-insect screen fabric components of EMCO® storm doors (including brass and nickel hardware finish and the mechanical functions of locksets, closers, windows and insect screens) to be free from defects in manufacturing, materials and workmanship for a period of one (1) year from the date of original retail purchase or for as long as the original consumer purchaser owns the home in which the door was initially installed, whichever is shorter. Kick panel retention within the frame is not covered under this warranty.

In the event a door frame, hinges, insulated glass or a component fails as a result of a defect in manufacturing, materials or workmanship within the limited warranty period specified above, and upon written proof of purchase, EMCO, at its option, will provide a replacement door frame, hinge, and/or components without charge – installation is not included. Such replacement or repair is warranted for the remainder of the original limited warranty period. Please locate the door serial number and written proof of purchase and contact EMCO Consumer Support at 1-800-933-3626.

“OOPS-PROOF” INSTALLATION LIMITED WARRANTY

EMCO Enterprises, Inc. (EMCO) warrants that any part lost or mis-cut during the original installation of your EMCO storm door will be repaired or replaced at no additional charge within ninety (90) days of the date of original purchase. This limited warranty will not apply if the part has been misused, abused or altered. Cutting parts not specified by the installation guide or mis-drilled parts are not included in this warranty.

In the event a part is lost or mis-cut within the limited warranty period, EMCO, at its option, will provide the appropriate replacement part – installation is not included. Please locate the door serial number and written proof of purchase and contact EMCO Consumer Support at 1-800-933-3626.

GENERAL LIMITED WARRANTY INFORMATION

The limited warranties set forth in this document are the only express warranties (whether written or oral) applicable to EMCO® storm doors, and no one is authorized to modify or expand these limited warranties. All warranty claims must be made during the applicable warranty periods.

ALL IMPLIED WARRANTIES INCLUDING MERCHANTABILITY AND FITNESS FOR A PARTICULAR PURPOSE ARE LIMITED TO THE APPLICABLE STATUTE OF LIMITATION, BUT IN NO CASE WILL THEY EXTEND BEYOND THE TERM OF THE LIMITED WARRANTIES SET FORTH ABOVE. EMCO EXCLUDES AND WILL NOT PAY FOR INCIDENTAL OR CONSEQUENTIAL DAMAGES, WHETHER ARISING OUT OF CONTRACT, TORT OR OTHERWISE, AND ITS LIABILITY WILL IN ALL INSTANCES BE LIMITED TO THE REPAIR OR REPLACEMENT OF THE DEFECTIVE PRODUCT.

Some states do not allow the exclusion of incidental and consequential damages, or limitation of the duration of an implied warranty, so the above limitations or exclusions may not apply to you.

This limited warranty gives you specific legal rights, and you may also have other rights that may vary from state to state and in Canada.

What is NOT covered by this limited warranty: Damage caused by 1) improper installation, maintenance, or use 2) chemicals or airborne pollutants, such as salt or acid rain; 3) acts of God, including wind damage; 4) Products not manufactured by EMCO

EMCO Enterprises, Inc. is a wholly owned subsidiary of Andersen Corporation. EMCO manufactures Andersen® and EMCO® storm doors. EMCO supports the limited warranties covering Andersen® Storm and Screen Doors. “Andersen”, “EMCO” and all other marks where denoted are trademarks of Andersen Corporation. ©2013 Andersen Corporation. All rights reserved.

Reprinted and effective as of May, 2011.

Online Parts and Knowledge Store

Andersen is committed to helping you find parts quickly and easily for your Andersen® or EMCO® storm door. Use the site below and your serial number to find many of the most-common replacement parts for your storm door.

This site also includes the Andersen Storm Door Learning Center. Whether you are trying to find other Andersen® or EMCO® products or you are looking for replacement part installation guides, or other care and maintenance topics and tips, this is a great place to start.

parts.andersenstormdoors.com