

INSTALLATION

Before Installing the Range

Make sure your range is properly installed and grounded by a qualified installer, according to the installation instructions. Any adjustment and service should be performed only by qualified gas range installers or service technicians.

In the Commonwealth of Massachusetts

- This product must be installed by a licensed plumber or gas fitter.
- When using ball type gas shut-off valves, they must be the T-handle type.
- When using a flexible gas connector, it must not exceed 3 feet in length.

Preparing for Installation

Tools Needed



Phillips screwdriver



Flat-blade screwdriver



Pencil and ruler

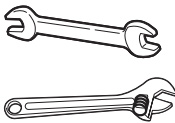

Open-end or adjustable wrench

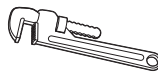

Pipe wrench (2)
(one for support)



Level

Materials You May Need

- Gas line shut-off valve
- Pipe joint sealant that resists action of natural and LP gases
- Flexible metal appliance connector ($\frac{3}{4}$ " or $\frac{1}{2}$ " NPT x $\frac{1}{2}$ " I.D.)
Never use an old connector when installing a new range.
- Flare union adapter for connection to gas supply line ($\frac{3}{4}$ " or $\frac{1}{2}$ " NPT x $\frac{1}{2}$ " I.D.)
- Flare union adapter for connection to pressure regulator on range ($\frac{1}{2}$ " NPT x $\frac{1}{2}$ " I.D.)
- Liquid leak detector or soapy water
- Lag bolt or $\frac{1}{2}$ " O.D. sleeve anchor (for concrete floors only)

Installing the Range

Unpacking and Moving the Range

CAUTION

- **You should use two or more people to move and install the range. (Excessive Weight Hazard)** Failure to do so can result in back or other injury.
- **Do not use the door handles to push or pull the range during installation or when moving the range out for cleaning or service.** Doing so can result in serious damage to the door of the range.

Remove packing material, tape and any temporary labels from your range before using. Do not remove any warning-type labels, the model and serial number label, or the Tech Sheet that is located on the back of the range.

To remove any remaining tape or glue, rub the area briskly with your thumb. Tape or glue residue can also be easily removed by rubbing a small amount of liquid dish soap over the adhesive with your fingers. Wipe with warm water and dry.

Do not use sharp instruments, rubbing alcohol, flammable fluids, or abrasive cleaners to remove tape or glue. These products can damage the surface of your range.

Your range is heavy and can be installed on soft floor coverings such as cushioned vinyl or carpeting. Use care when moving the range on this type of flooring. Use a belt when moving the range to prevent damaging the floor. Or slide the range onto cardboard or plywood to avoid damaging the floor covering.

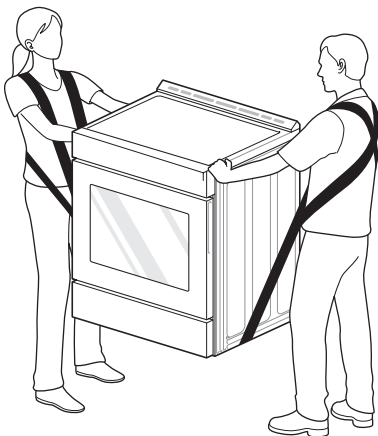

Choosing the Proper Location

Do not locate your range where it may be subject to strong drafts. Any openings in the floor or wall behind the range should be sealed. Make sure the openings around the base of the range that supply fresh air for combustion and ventilation are not blocked by carpeting or woodwork.

Your range, like many other household units, is heavy and can be installed on soft floor coverings such as cushioned vinyl or carpeting. Use care when moving the range on this type of flooring.

This appliance must not be installed with a ventilation system that blows air downward toward the range. This type of ventilation system may cause ignition and combustion problems with the gas cooking appliance resulting in personal injury or unintended operation.

When the floor covering ends at the front of the range, the area that the range will be installed on should be built up with plywood to the same level or higher than the floor covering. This will allow the range to be moved for cleaning and servicing, as well as provide proper air flow to the range.

Also, make sure the floor covering can resist temperatures of at least 167 °F (75 °C). See the Installation Safety Instructions included in this manual.

Make sure the wall coverings around your range can resist the heat generated up to 194 °F (90 °C) by the range. See the Installation Safety Instructions included in this manual.

Gas Pipe and Electrical Outlet Locations

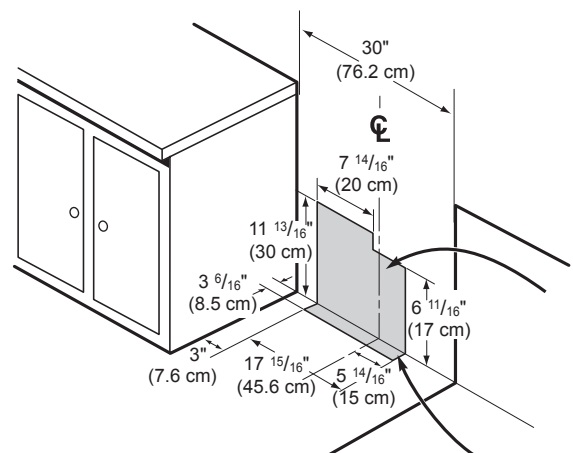

Dimensions and Clearances

Provide proper clearance between the range and adjacent combustible surfaces. These dimensions must be met for safe use of your range. The location of the electrical outlet and pipe opening (see Gas Pipe and Electrical Outlet Locations, page 14) may be adjusted to meet specific requirements. The range may be placed with 0" clearance (flush) at the back wall.

Installation Clearances

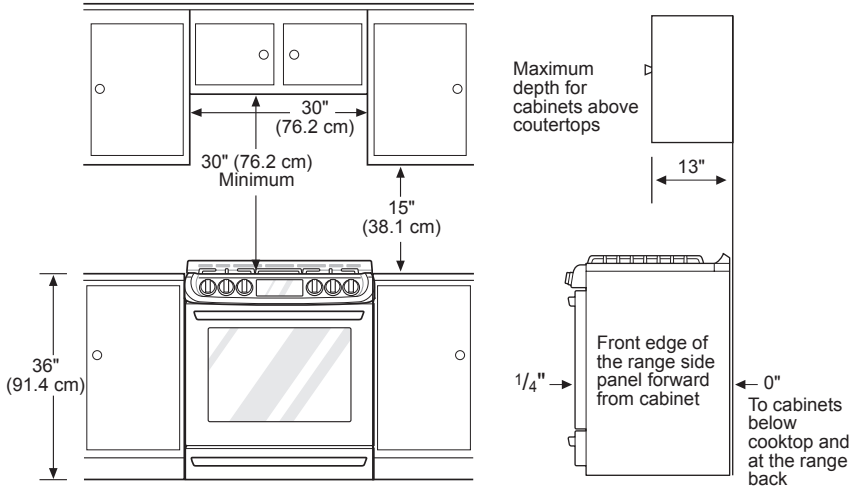

Dimensions

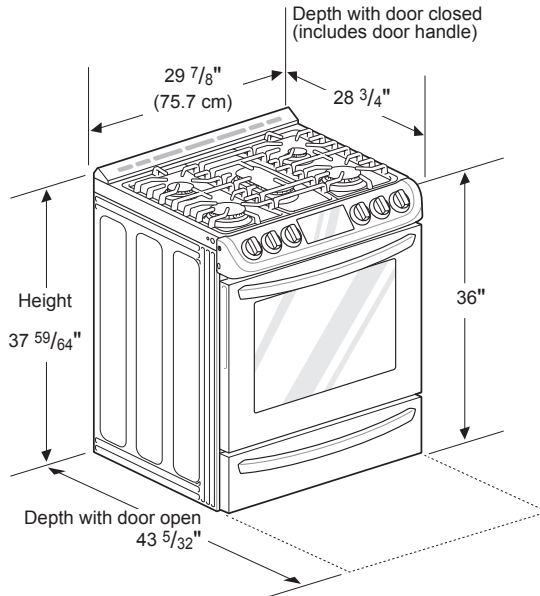

Installing the Anti-tip Device

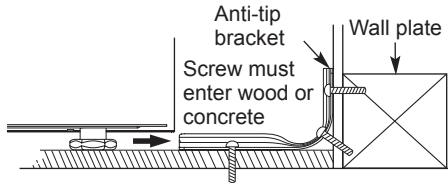

The anti-tip bracket is packaged with an installation template. The instructions include necessary information to complete the installation. Read and follow the range installation instruction sheet.

WARNING

- Range must be secured with an approved anti-tip device.
- The range could be tipped by standing, sitting or leaning on an open door if the range or anti-tip device is not properly installed.
- After installing the anti-tip device, verify that it is in place by carefully attempting to tilt the range forward.
- This range has been designed to meet all recognized industry tip standards for all normal conditions.
- The installation of the anti-tip device must meet all local codes for securing the appliance.
- The use of this device does not preclude tipping of the range when not properly installed.

Optional Rear Filler

If the counter does not bridge the opening at the rear wall the rear filler kit, that is provided with the slide in range, will be needed.

NOTE

If the countertop depth is greater than 25" there will be a gap between the filler kit and the back wall.

If the countertop depth is less than 24", the control panel will not sit flush with the countertop.

Installing the Rear Filler

- 1 Using a screwdriver, remove the upper four screws that attach the rear bracket and loosen the lower two screws.
- 2 Place the rear filler on the rear bracket.

- 3 Tighten the two lower screws on the rear bracket. Insert one of the screws removed in step 1 in the slot at each end of the rear filler.
- 4 Store the remaining two screws with these instructions for future use.

Providing Adequate Gas Supply

Your range is designed to operate at a pressure of 5" of water column on natural gas or 10" of water column on LP.

Make sure you are supplying your range with the type of gas for which it is configured.

This range is convertible for use on natural or LP gas. When using this range on LP gas, conversion must be made by a qualified LP installer before attempting to operate the range.

For proper operation, the pressure of natural gas supplied to the regulator must be between 5" and 13" of water column.

For LP gas, the pressure supplied to the regulator must be between 10" and 13" of water column. When checking for correct operation of the regulator, the inlet pressure must be at least 1" more than the operating (manifold) pressure as given above.

The pressure regulator located at the inlet of the range must remain in the supply line regardless of which type of gas is being used.

A flexible metal appliance connector used to connect the range to the gas supply line should have an I.D. of $\frac{5}{8}$ " and a maximum length of 5 feet. In Canada, flexible connectors must be single wall metal connectors less than 6 feet in length.

Connecting the Range to Gas

Shut off the range gas supply valve before removing the old range and leave it off until the new hook-up has been completed.

Because hard piping restricts movement of the range, the use of a CSA International-certified flexible metal appliance connector should be used unless local codes require a hard-piped connection.

A manual valve shall be installed in an accessible location in the gas piping external to the appliance for the purpose of turning on or shutting off gas to the appliance.

Never reuse an old connector when installing a new range.

To protect against gas leaks, use a qualified pipe joint sealant on all external threads.

- 1 Install a male 1/2" or 3/4" flare union adapter to the NPT internal thread of the manual shut-off valve, taking care to back-up the shut-off valve to keep it from turning.
- 2 Install a male 1/2" flare union adapter to the 1/2" NPT internal thread at the inlet of the pressure regulator. Use a backup wrench on the pressure regulator fitting to prevent damage.

In an emergency situation or if you want to shut off the gas supply, close the regulator valve by positioning the lever as shown in the figure below.

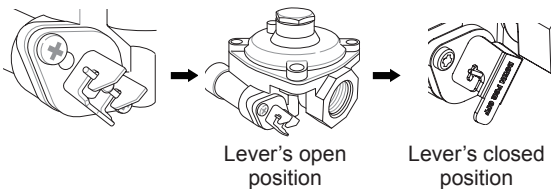

- 3 Connect a flexible metal appliance connector to the adapter on the range. Position the range to permit connection at the shut-off valve.
- 4 When all connections have been made, be sure all range controls are in the **Off** position and turn on the main gas supply valve. Gas leaks may occur in your system and create a hazard. Gas leaks may not be detected by smell alone.
Check all gas connection joints and fittings for leaks with a non-corrosive leak detection fluid, then wipe off.
Gas suppliers recommend you purchase and install a UL approved gas detector. Install and use in accordance with the installation instructions.

! WARNING

- Do not use a flame to check for gas leaks.
- Isolate the range from the gas supply system by closing its individual shut-off valve during any pressure testing of the gas supply system at test pressures equal to or less than 1/2" psig (3.5 kPa).

Flexible Connector Hookup

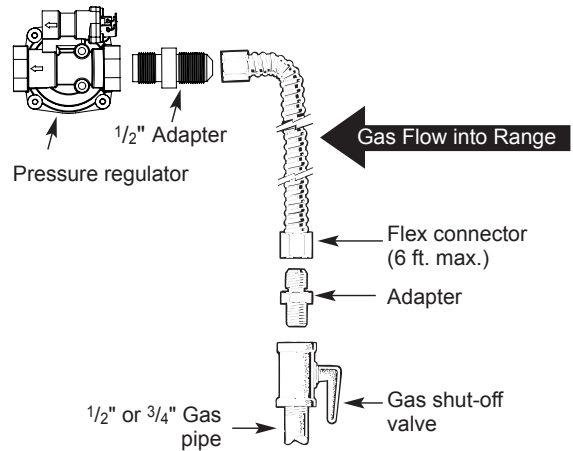

Installer: Inform the consumer of the location of the gas shutoff valve.

Pressure Regulator Position

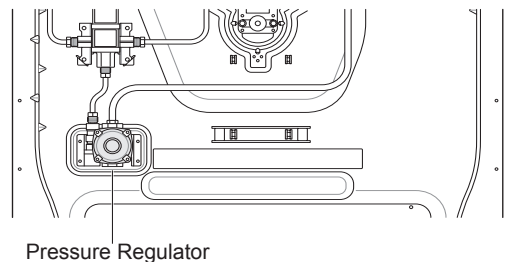

Electrical Connections

Electrical Requirements

120 Volt, 60 Hz, properly grounded dedicated circuit protected by a 15 or 20 Amp circuit breaker, or slow blow fuse.

If an external electrical source is utilized, the appliance, when installed, must be electrically grounded in accordance with local codes or, in the absence of local codes, with the National Electrical Code, ANSI/NFPA 70.

Grounding

IMPORTANT: FOR PERSONAL SAFETY, THIS APPLIANCE MUST BE PROPERLY GROUNDED.

The power cord of this appliance is equipped with a 3-prong (grounding) plug which mates with a standard 3-prong grounding wall receptacle to minimize the possibility of electric shock hazard from this appliance.

The customer should have the wall receptacle and circuit checked by a qualified electrician to make sure the receptacle is properly grounded.

Where a standard two-prong wall receptacle is encountered, it is the personal responsibility and obligation of the customer to have it replaced with a properly grounded three-prong wall receptacle.

DO NOT, UNDER ANY CIRCUMSTANCES, CUT OR REMOVE THE THIRD (GROUND) PRONG FROM THE POWER CORD.

A word about GFCI's – GFCI's are not required or recommended for gas range receptacles.

Ground Fault Circuit Interrupters (GFCI's) are devices that sense leakage of current in a circuit and automatically switch off power when a threshold leakage level is detected. These devices must be manually reset by the consumer. The National Electrical Code requires the use of GFCI's in kitchen receptacles installed to serve countertop surfaces.

Performance of the range will not be affected if operated on a GFCI-protected circuit but the occasional resetting of the circuit can become an annoyance.

Preferred Method



Do not use an adapter plug. Disconnecting of the power cord places undue strain on the adapter and leads to eventual failure of the adapter ground terminal.

Installation must conform with local codes or, in the absence of local codes, with the National Fuel Gas Code, ANSI Z223.1/NFPA 54.

The installation of appliances designed for mobile home installation must conform with the Manufactured Home Construction and Safety Standard, Title 24 CFR, Part 3280 (formerly the Federal Standard for Mobile Home Construction and Safety, Title 24, HUD, Part 280) or, when such standard is not applicable, the Standard for Manufactured Home Installations, latest edition (Manufactured Home Sites, Communities and Set-Ups), ANSI A225.1, latest edition, or with local codes. In Canada, mobile home installation must be in accordance with the current CAN/CSA Z240/MH Mobile Home Installation Code.

Sealing the Openings

Seal any openings in the wall and floor after electrical and gas supplies are completed.

CAUTION

Have the circuit checked by a qualified electrician to make sure the receptacle is properly grounded.

Assembling the Surface Burners

CAUTION

Do not operate the burners without all parts in place.

Place the burner caps and heads on the cooktop. Make sure that the caps and heads are placed in the correct locations. There is one small, one medium, one large, one oval(center), and one extra large burner head and cap.

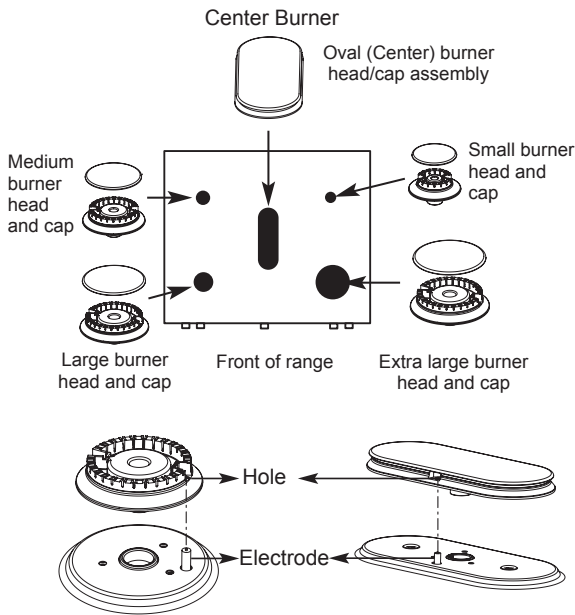

Make sure the hole in the burner head is positioned over the electrode.

Checking Ignition of the Surface Burners

Electric Ignition

Select a surface burner knob and simultaneously push in and turn to the **Lite** position. You will hear a clicking sound indicating proper operation of the spark module.

Once the air has been purged from the supply lines the burner should ignite within 4 seconds. After the burner ignites, rotate the knob out of the **Lite** position. Try each burner in succession until all burners have been checked.

Quality of Flames

The combustion quality of the burner flames needs to be confirmed visually.



A **Yellow flames** - Call for service.



B **Yellow tips on outer cones** - This is normal for LP gas.



C **Soft blue flames** - This is normal for natural gas.

NOTE

- With LP gas, some yellow tipping on outer cones is normal.

Adjusting the Surface Burner to the Low Flame (Simmer) Setting

- 1 Light all surface burners.
- 2 Turn the knob on the burner being adjusted to **Lo**.
- 3 Remove the knob.
- 4 Insert a small, flat-blade screwdriver into the valve shaft.

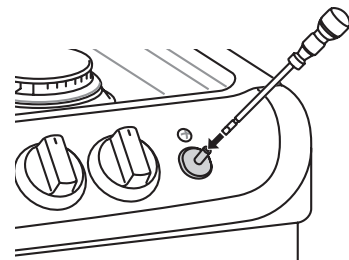

NOTE

Hold the valve shaft with one hand while turning the screw to adjust with the other.

- 5 Replace the knob.
- 6 Test the flame stability.

Test 1: Turn the knob from **Hi** to **Lo** quickly. If the flame goes out, increase the flame size and test again.

Test 2: With the burner on a **Lo** setting, open and close the oven door quickly. If the flame is extinguished by the air currents created by the door movement, increase the flame height and test again.
- 7 Repeat steps 1-6 for each surface burner.

Checking Operation of Bake / Broil Burners

To check ignition of the Bake burner, follow the steps below:

- 1 Remove all packing materials from inside the oven cavity.
- 2 Turn oven mode knob to select **Bake**. 350 °F appears in the display.
- 3 Press **Start**.

It may take between 30 and 90 seconds for the burner to start heating.

To check ignition of the Broil burner, follow the steps below:

- 1 Turn oven mode knob to select **Broil High**. **Hi** appears in the display.
- 2 Make sure the door is closed.
- 3 Press **Start**.

It may take between 30 and 90 seconds for the burner to start heating.

NOTE

Do not try to light either the Bake or Broil burners during a power outage. The range has an electrical ignition system and cannot be used without power.

Adjusting Air Shutters (for LP Conversions)

The range comes from the factory with the air shutters adjusted for proper air flow for natural gas. If converted to LP, follow the instructions provided in the conversion kit to properly adjust the air shutters. LP conversion must be performed by a qualified technician.

Leveling the Range

Level the range by adjusting the leveling legs. Extending the legs slightly may also make it easier to insert the rear leg into the anti-tip bracket.

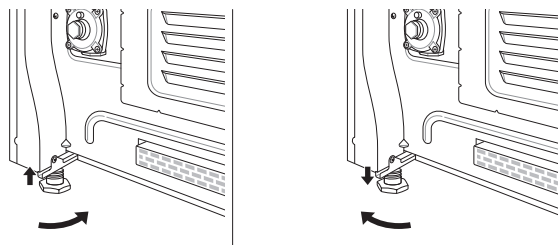

Use a level to check your adjustments. Place the level diagonally on the oven rack, and check each direction for level.

First check direction ①.

Then check direction ②. If the level doesn't show level on the rack, adjust the leveling legs.

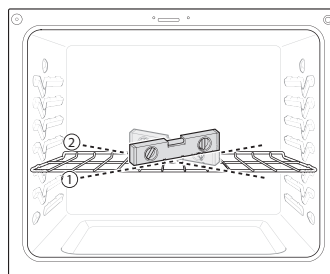

Engaging the Anti-tip Device

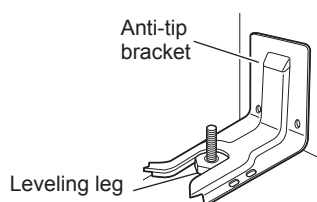

- 1 Slide the range against the wall, making sure the back leg slides into and engages the anti-tip bracket.
- 2 Check for proper installation by grasping the front edge of the cooktop and carefully attempting to tilt the range forward.

OPERATION

Gas Surface Burners

Before Use

Read all instructions before using.

Make sure that all burners are properly placed.

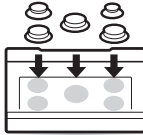

Make sure that all grates are properly placed before using the burner.

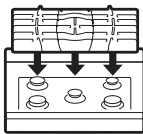

CAUTION

Do not operate the burner for an extended period of time without cookware on the grate.

The finish on the grate may chip without cookware to absorb the heat.

Make sure the burners and grates are cool before touching them, or placing a pot holder, cleaning cloth, or other materials on them.

Touching grates before they cool down may cause burns.



CAUTION

WHAT TO DO IF YOU SMELL GAS

- Open windows.
- Do not try to light any appliance.
- Do not touch any electrical switch.
- Do not use any phone in your building.
- Immediately call your gas supplier from a neighbor's phone. Follow the gas supplier's instructions.
- If you cannot reach your gas supplier, call the fire department.

NOTE

Electric spark igniters from the burners cause a clicking noise. All the spark igniters on the cooktop will activate when igniting just one burner.

Burner Locations

Your gas range cooktop has four or five sealed gas burners, depending on the model. These can be assembled and separated. Follow the guide below.

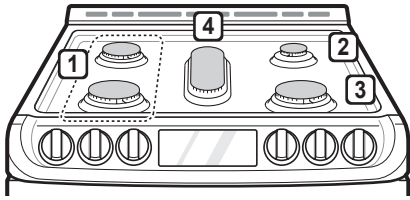

1 Medium and Large Burners

The medium and large burners are the primary burners for most cooking. These general purpose burners can be turned down from **Hi** to **Lo** to suit a wide range of cooking needs.

2 Small Burner

The smallest burner is used for delicate foods such as sauces or foods that require low heat for a long cooking time.

3 Extra Large Burner

The extra large burner is the maximum output burner. Like the other four burners, it can be turned down from **Hi** to **Lo** for a wide range of cooking applications. This burner is also designed to quickly bring large amounts of liquid to a boil. It can be used with cookware 10 inches or larger in diameter.

4 Oval Burner

The center, oval burner is for use with a griddle or oval pots.

Using the Gas Surface Burners

- 1 Be sure that all of the surface burners and grates are placed in the correct positions.
- 2 Place cookware on the grate.
- 3 Push the control knob and turn to the **Lite** position.

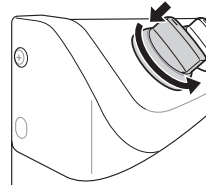

The electric spark ignition system makes a clicking noise.

- 4 Turn the control knob to control the flame size.

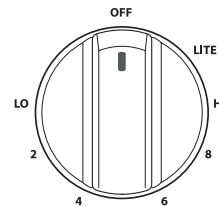

CAUTION

Do not attempt to disassemble or clean around any burner while another burner is on. All the burners spark when any burner is turned to **Lite**. An electric shock may result causing you to knock over hot cookware.

Setting the Flame Size

Watch the flame, not the knob, as you reduce heat. Match the flame size on a gas burner to the cookware being used for fastest heating.

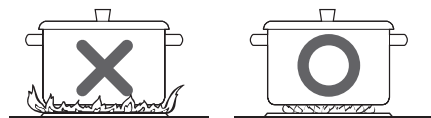

CAUTION

Never let the flames extend up the sides of the cookware.

NOTE

- The flames on the surface burners may burn yellow in the presence of high humidity, such as a rainy day or a nearby humidifier.
- After LP gas conversion, flames can be bigger than normal when you put a pot on the surface burner.

In Case of Power Failure

In case of a power failure, you can light the gas surface burners on your range with a match.

Surface burners in use when an electrical power failure occurs will continue to operate normally.

- 1 Hold a lit match to the burner, then push in the control knob.
- 2 Turn the control knob to the **Lo** position.

CAUTION

Use extreme caution when lighting burners with a match. It can cause burns and other damage.

Range-Top Cookware

Aluminum	Medium-weight cookware is recommended because it heats quickly and evenly. Most foods brown evenly in an aluminum skillet. Use saucepans with tight fitting lids when cooking with minimum amounts of water.
Cast-Iron	If heated slowly, most skillets will give satisfactory results.
Stainless Steel	This metal alone has poor heating properties and is usually combined with copper, aluminum or other metals for improved heat distribution. Combination metal skillets work satisfactorily if they are used with medium heat as the manufacturer recommends.
Enamelware	Under some conditions, the enamel of this cookware may melt. Follow cookware manufacturer's recommendations for cooking methods.
Glass	There are two types of glass cookware. Those for oven use only and those for top-of-range cooking.
Heatproof Glass Ceramic	Can be used for either surface or oven cooking. It conducts heat very slowly and cools very slowly. Check cookware manufacturer's directions to be sure it can be used on gas ranges.

Using a Wok

If using a wok, use a 14-inch or smaller flat-bottomed piece of wok. Make sure that the wok bottom sits flat on the grate.

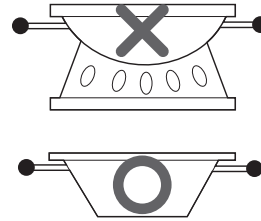

Use flat-bottomed wok

CAUTION

Do not use a wok support ring. Placing the ring over the burner or grate may cause the burner to work improperly, resulting in carbon monoxide levels above allowable standards. This can be hazardous to your health.

Using Stove-Top Grills

Do not place stove-top grills on the burner.



CAUTION

Do not use stove top grills on the surface burners. Using a stove top grill on the surface burner will cause incomplete combustion and can result in exposure to carbon monoxide levels above allowable current standards. This can be a health hazard.

Using the Griddle

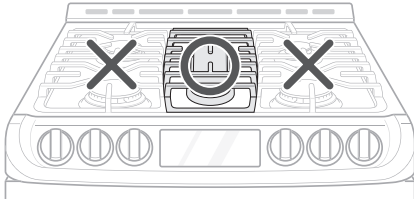

The non-stick coated griddle provides an extra-large cooking surface for meats, pancakes or other food usually prepared in a frying pan or skillet.

NOTE

It is normal for the griddle to become discolored over time.

How to Place the Griddle: The griddle can only be used with the center burner. The griddle must be properly placed on the center grate, as shown below.

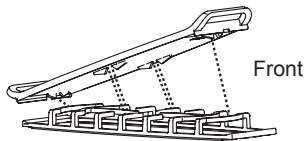

CAUTION

- Do not remove the center grate when using the griddle.
- Do not remove the griddle plate until the cooktop grates, surfaces and griddle plate have completely cooled.
- The griddle plate on the cooktop may become very hot when using the cooktop, oven or broiler systems. Always use oven mitts when placing or removing the griddle plate.

Preheat the griddle according to the guide below and adjust for the desired setting.

Type of Food	Preheat Conditions	Cook Setting
Warming Tortillas	-	5 (MED)
Pancakes	HI 5 min.	HI
Hamburgers	HI 5 min.	HI
Fried Eggs	HI 5 min.	HI
Bacon	HI 5 min.	HI
Breakfast Sausage Links	HI 5 min.	HI
Hot Sandwiches	HI 5 min.	HI

NOTE

After cooking on the griddle for an extended period, adjust the griddle temperature settings as the griddle retains heat.

IMPORTANT NOTES

- Avoid cooking extremely greasy foods as grease spillover can occur.
- The griddle can become hot when surrounding burners are in use.
- Do not overheat the griddle. This can damage the non stick coating.
- Do not use metal utensils that can damage the griddle surface. Do not use the griddle as a cutting board.
- Do not place or store items on the griddle.

The Oven

Before Use

Read all instructions before using.

Make sure the electrical power cord and the gas valve are properly connected.

Confirm the correct usage of the range for the type of food you will cook.

Make sure you know how to use the oven (temperature setting, time setting and recipe) for best results.

⚠ CAUTION

WHAT TO DO IF YOU SMELL GAS

- Open windows.
- Do not try to light any appliance.
- Do not touch any electrical switch.
- Do not use any phone in your building.
- Immediately call your gas supplier from a neighbor's phone. Follow the gas supplier's instructions.
- If you cannot reach your gas supplier, call the fire department.

NOTE

If using an oven thermometer in the oven cavity, temperatures may differ from the actual set oven temperature with all modes.

In case of power failure, do not use the oven.

The oven and broiler cannot be used during a power outage. If the oven is in use when a power failure occurs, the oven burner shuts off and cannot be re-lit until power is restored. Once power is restored, you will need to reset the oven (or Broil function).

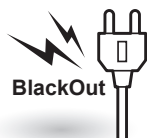

⚠ CAUTION

Do not attempt to operate the electric ignition during an electrical power failure.

Do not block, touch or place items around the oven vent during cooking.

Your oven is vented through ducts at the center above the burner grate. Do not block the oven vent when cooking to allow for proper air flow. Do not touch vent openings or nearby surfaces during any cooking operation.

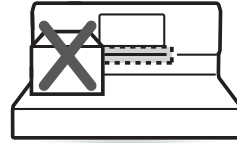

⚠ CAUTION

- Do not place plastic or flammable items on the cooktop. They may melt or ignite if left too close to the vent.
- Do not place closed containers on the cooktop. The pressure in closed containers may increase, which may cause them to burst.
- Metal items will become very hot if they are left on the cooktop, and could cause burns.
- Handles of pots and pans on the cooktop may become hot if left too close to the vent.

Do not cover racks or oven bottom with aluminum foil.



You may see condensation on the oven door glass.

As the oven heats up, the heated air in the oven may cause condensation to appear on the oven door glass. These water drops are harmless and will evaporate as the oven continues to heat up.

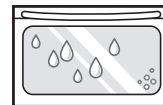

Control Panel Overview

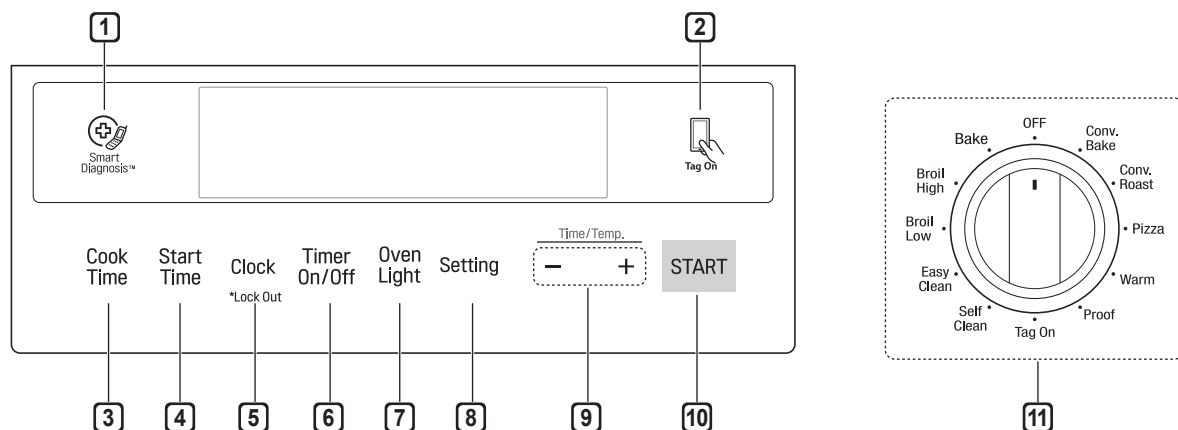

1 Smart Diagnosis™

Use during the Smart Diagnosis feature.

2 Smart Features

The Tag On icon, for use with Smart Features.

3 Cook Time

Press the button to set the desired amount of time for food to cook. The oven shuts off when the set cooking time runs out.

4 Start Time

Press the button to set the delayed timed cook. The oven starts at the set time.

5 Clock / Lockout

- Press button to set the time of day.
- Press and hold button for three seconds to lock the door and control panel.

6 Timer On/Off

Press the button to set or cancel timer on oven.

7 Oven Light

Press the button to turn oven light on or off.

8 Setting

Press button to select and adjust oven settings.

9 - /+

Press the plus button to increase cooking time or oven temperature.
Press the minus button to decrease cooking time or oven temperature.

10 Start

Press the button to start all oven features.

11 Oven Mode Knob

Turn the knob to select oven operating mode.

Flashing Clock

If the colon in the clock display flashes, press **Cook Time** for three seconds and reset the clock, or press any key to stop the flashing.

Changing Oven Settings

Clock

The clock must be set to the correct time of day in order for the automatic oven timing functions to work properly.

- 1 Set the oven mode knob to the **Off** position.
- 2 Press and hold **Cook Time** for three seconds or press **Clock**. **CLO** shows in the display.
- 3 Press **plus(+)** or **minus(-)** to select the desired time. **Plus(+)** to increase the time and **minus(-)** to decrease the time.
- 4 Press **Start** to enter the time and start the clock.

NOTE

- The time of day cannot be changed during a timed baking or self-clean cycle.
- If no other keys are pressed within 25 seconds of pressing **Clock**, the display reverts to the original setting.
- If the display colon in the clock is blinking, you may have experienced a power failure. Reset the time.

Oven Light

The interior oven light automatically turns on when the door is opened. Press **Light** to manually turn the oven light on.

NOTE

The oven light cannot be turned on if the Self Clean function is active.

Minimum & Maximum Default Settings

All of the features listed have a minimum and a maximum time or temperature setting that can be entered into the control. A beep sounds each time a control key is pressed.

Two short tones sound if the entry of the temperature or time is below the minimum or above the maximum setting for the feature.

Feature	min. Temp. / Time	max. Temp. / Time	Default
Clock	12 Hr.	1:00 Hr. / min.	12:59 Hr. / min.
	24 Hr.	0:00 Hr. / min.	23:59 Hr. / min.
Timer	12 Hr.	0:10 min. / sec.	11:59 Hr. / min.
	24 Hr.	0:10 min. / sec.	11:59 Hr. / min.
Cook Time	12 Hr.	0:01 Hr. / min.	11:59 Hr. / min.
	24 Hr.	0:01 Hr. / min.	11:59 Hr. / min.
Conv. Bake	300 °F / 150 °C	550 °F / 285 °C	350 °F (*325 °F) / 12 Hr.
Conv. Roast	300 °F / 150 °C	550 °F / 285 °C	350 °F (*325 °F) / 12 Hr.
Broil	Lo 400 °F	Hi 500 °F	Hi / 3 Hr.
Bake	170 °F / 80 °C	550 °F / 285 °C	350 °F / 12 Hr.
Proof	0:01 min.	11:59 Hr. / min.	12 Hr.
Pizza			12 Hr.
Warm			3 Hr.
Self Clean	2 Hr.	5 Hr.	3 Hr.
EasyClean®			10 min.

* Using Auto Conversion

- Default cook mode times are without setting cook time.

Timer On/Off

The Timer On/Off serves as an extra timer in the kitchen that beeps when the set time has run out. It does not start or stop cooking.

The Timer On/Off feature can be used during any of the oven control functions.

For example to set 5 minutes

- 1 Set the oven mode knob to the **Off** position.
- 2 Press the **Timer On/Off**. 0:00 with **HR** inside it appears and **Timer** flashes in the display.
- 3 Press **plus(+)** or **minus(-)** to set the desired time. **Plus(+)** to increase the time and **minus(-)** to decrease the time.
- 4 Press **Timer On/Off** or **Start** to start the Timer. The remaining time countdown appears in the display.

NOTE

If **Timer On/Off** is pressed, the timer returns to the time of day.

- 5 When the set time runs out, **End** shows in the display. The indicator tones sound every 15 seconds until **Timer On/Off** is pressed.

NOTE

- If the remaining time is not in the display, recall the remaining time by pressing **Timer On/Off**.
- Press **Timer On/Off** twice to set the time in minutes and seconds.
- Press **Timer On/Off** once to set the time in hours and minutes.

Cancelling the Timer

- 1 Press **Timer On/Off** once. The display returns to the time of day.

Settings

Set the oven mode knob to the **Off** position. Press and hold **Start Time** for three seconds or press **Setting**.

Then press the **Start Time** or **Setting** key repeatedly to toggle through and change oven settings.

The **Settings** key allows you to:

- set the hour mode on the clock (12 or 24 hours)
- enable/disable convection auto conversion
- adjust the oven temperature
- activate/deactivate the preheating alarm light
- set the beeper volume
- switch the temperature scale between Fahrenheit and Celsius

Setting the Hour Mode

The control is set to use a 12-hour clock. To reset the clock to 24-hour mode, follow the steps below.

- 1 Set the oven mode knob to the **Off** position.
- 2 Press and hold **Start Time** for three seconds or press **Setting**.
- 3 Press **plus(+)** or **minus(-)** to set the desired hour mode on the clock.
- 4 Press **Start** to accept the desired change.

Setting Convection Auto Conversion

When **Conv. Bake** and **Conv. Roast** are selected, Convection Auto Conversion automatically converts the standard recipe temperature entered to a convection temperature by subtracting 25 °F / 14 °C. This auto-converted temperature shows on the display. For example, select **Conv. Bake**, enter 350 °F, and 325 °F shows on the display after preheat.

Convection Auto Conversion is enabled by default. To change the setting, follow these instructions.

- 1 Set the oven mode knob to the **Off** position.
- 2 Press and hold **Start Time** for 3 seconds or press **Setting**. Then press **Start Time** or **Setting** repeatedly until **Auto** appears in the display.
- 3 Press **plus(+)** or **minus(-)** to enable or disable the feature.
- 4 Press **Start** to accept the change.

Adjusting the Oven Thermostat

Your new oven may cook differently from the one it replaced. Use your new oven for a few weeks to become more familiar with it before changing the temperature settings. If after familiarizing yourself with the new oven, you still think that it is too hot or too cold, you can adjust the oven thermostat yourself.

NOTE

To begin, either raise or lower the thermostat 15 °F (8 °C). Try the oven with the new setting. If the oven still needs adjustment, raise or lower the thermostat again, using the first adjustment as a gauge. For example, if the adjustment was too much, raise or lower the thermostat 10 °F (5 °C). If the adjustment was not enough, raise or lower the thermostat 20 °F (12 °C). Proceed in this way until the oven is adjusted to your satisfaction.

- 1 Set the oven mode knob to the **Off** position.
- 2 Press and hold **Start Time** for three seconds or press **Setting**. Then press **Start Time** or **Setting** repeatedly until **AdJU** appears in the display.
- 3 To increase the temperature, press **plus (+)** until the desired amount appears in the display. To decrease the temperature, press **minus (-)** until the desired amount appears in the display.
- 4 Press **Start** to accept the change.

NOTE

- This adjustment does not affect the broiling or Self Clean temperatures. The adjustment is retained in memory after a power failure. The oven thermostat can be increased (+) or decreased (-) as much as 35 °F or 19 °C.
- Once the thermostat is increased or decreased, the display shows the adjusted temperature until it readjusts.

Turning the Preheat Alarm Light On/Off

When the oven reaches its set-temperature, the preheating alarm light flashes 5 times or until the oven door is opened.

You can activate or deactivate the preheating alarm light.

- 1 Set the oven mode knob to the **Off** position.
- 2 Press and hold **Start Time** for three seconds or press **Setting**. Then press **Start Time** or **Setting** repeatedly until **PrE** appears in the display.
- 3 Press **plus(+)** or **minus(-)** to turn the function on/off.
- 4 Press **Start** to accept the change.

Adjusting the Beeper Volume

- 1 Set the oven mode knob to the **Off** position.
- 2 Press and hold **Start Time** for three seconds or press **Setting**. Then press **Start Time** or **Setting** repeatedly until **Beep** appears in the display.
- 3 Press **plus(+)** or **minus(-)** to select the desired volume.
- 4 Press **Start** to accept the change.



Selecting Fahrenheit or Celsius

Set the oven temperature display to show either Fahrenheit (°F) or Celsius (°C) units. The oven defaults to Fahrenheit unless changed by the user.

- 1 Set the oven mode knob to the **Off** position.
- 2 Press and hold **Start Time** for three seconds or press **Setting**. Then press **Start Time** or **Setting** repeatedly until **Unit** appears in the display.
- 3 Press **plus(+)** or **minus(-)** to select F(Fahrenheit) or C(Centigrade).
- 4 Press **Start** to accept the change.

Lockout

The Lockout feature automatically locks the oven door and prevents most oven from being turned on. It does not disable the timer and the interior oven light.

- 1 Set the oven mode knob to the **Off** position.
- 2 Press and hold **Probe** or **Clock** for three seconds.
- 3 The lock melody sounds, **Loc** appears in the display and the lock icon  blinks in the display.
- 4 Once the oven door is locked, the lock  indicator stops blinking and remains on.
- 5 To deactivate the Lockout feature, press and hold **Probe** or **Clock** for three seconds. The unlock melody sounds and the door and the controls unlock.

Start Time (Delayed Timed Cook)

The automatic timer of the Delayed Timed Cook function turns the oven on and off at the time you select. This feature can be used with the **Bake**, **Conv. Bake** and **Conv. Roast** modes.

Setting a Delayed Timed Cook

For example, to bake at 300 °F and delay the start of baking until 4:30, first set the clock for the correct time of day.

- 1 Turn the oven mode knob to select the **Bake** mode. 350 °F appears in the display.
- 2 Set the temperature: press **minus(-)** until 300 °F appears in the display.
- 3 Press **Cook Time** and set the baking time.
- 4 Press **Start Time**.
- 5 Set the start time: press **plus(+)** until 4:30 appears in the display.
- 6 Press **Start**. A short beep sounds and **Timed Delay** and the start time appear in the display. The oven begins baking at the set start time.

NOTE

- To cancel the Delayed Timed Cook function, turn the oven mode knob to the **Off** position.
- To change the cooking time, repeat step 3 and press **Start**.
- If the oven clock is set as a 12-hour clock, you can delay the cook time for 12 hours. If the oven clock is set as a 24-hour clock, you can delay the cook time for 24 hours.

The oven will continue to cook for the set amount of time and then turn off automatically. When the cooking time has elapsed:

- **End** and the time of day show in the display.
- The cook end indicator tone sounds every 60 seconds until the oven mode knob is turned to the **Off** position.



CAUTION

- Use the automatic timer when cooking cured or frozen meats and most fruits and vegetables. Foods that can easily spoil, such as milk, eggs, fish, meat or poultry, should be chilled in the refrigerator. Even when chilled, they should not stand in the oven for more than 1 hour before cooking begins, and should be removed promptly when cooking is completed.
- Eating spoiled food can result in sickness from food poisoning.

Cook Time (Timed Cook)

Set the oven to cook for a specific length of time using the Timed Cook feature. This feature can only be used with the **Bake**, **Conv. Bake** and **Conv. Roast** modes.

Setting a Timed Cook

For example, to bake at 300 °F for 30 minutes, first set the clock to the correct time of day.

- 1 Turn the oven mode knob to select the **Bake** mode. 350 °F appears in the display.
- 2 Set the oven temperature. For this example, press **minus(-)** until 300 °F appears in the display.
- 3 Press **Cook Time**. **Timed** flashes in the display. **Bake**, 0:00 and 300 °F appear in the display.
- 4 Set the baking time: press **plus(+)** until 30:00 appears in the display. The baking time can be set for any amount of time between 1 minute and 11 hours and 59 minutes.
- 5 Press **Start**.

The oven will continue to cook for the set amount of time and then turn off automatically. When the cooking time has elapsed:

- **End** and the time of day show in the display.
- The cook end indicator tone sounds every 60 seconds until the oven mode knob is turned to the **Off** position.

Changing the Cook Time during Cooking

For example, to change the cook time from 30 minutes to 1 hour and 30 minutes, do the following.

- 1 Press **Cook Time**.
- 2 Change the baking time: press **plus(+)** until 1 hour and 30 minutes appears in the display.
- 3 Press **Start** to accept the change.

Removing and Replacing the Oven Racks

⚠ CAUTION

- Replace the oven racks before turning the oven on to prevent burns.
- Do not cover the racks with aluminum foil, or any other material, or place anything on the bottom of the oven. Doing so will result in poor baking performance and may damage the oven bottom.
- Only arrange oven racks when the oven is cool.

Removing Racks

- 1 While wearing oven mitts, grasp the oven rack*.
- 2 Pull the rack straight out until it stops.
- 3 Lift up the front of the rack.
- 4 Pull out the rack.

* When possible, adjust oven racks before using the oven. Always wear oven mitts if adjusting racks while the oven is on.

Replacing Racks

- 1 While wearing oven mitts, place the end of the rack on the support*.
- 2 Tilt the front end of the rack up.
- 3 Push the rack in.
- 4 Check that the rack is properly in place.

*When possible, adjust oven racks before using the oven. Always wear oven mitts if adjusting racks while the oven is on.

Recommended Baking and Roasting Guide

- Center pans on racks for best baking results. If baking with more than one pan, place the pans so that each one has at least 1" to 1½" of air space around it. Do not allow pans to touch the walls of the oven.
- If cooking on single rack, place the rack in the position suggested in the charts on the following pages. Center the cookware as shown in the upper rack of the multiple rack image.
- If cooking on multiple racks in the oven, place racks in positions 1 and 4. For best results, place the cookware as shown, centered on the top rack and toward the front on the bottom rack.

Multiple rack baking

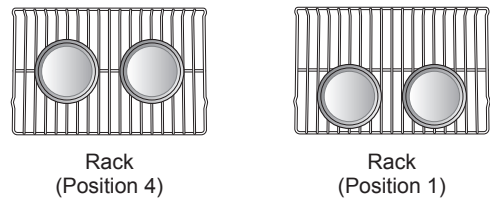

Single rack baking

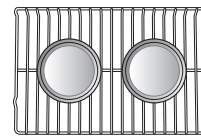

Rack

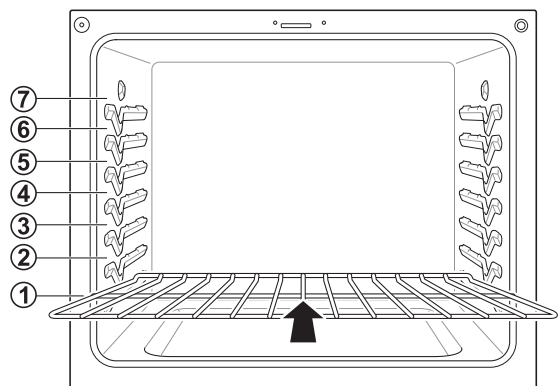

Bake

Bake is used to prepare foods such as pastries, breads and casseroles. The oven can be programmed to bake at any temperature from 170 °F (80 °C) to 550 °F (285 °C). The default temperature is 350 °F (175 °C).

Setting the Bake Function (example, 375 °F)

- 1 Turn the oven mode knob to select **Bake**.
- 2 Set the oven temperature: for example, press **plus(+)** until 375 °F appears in the display.
- 3 Press **Start**. The oven starts to preheat.

As the oven preheats, the temperature is displayed and rises in 5-degree increments. Once the oven reaches the set temperature, a tone sounds and the oven light blinks on and off.

- 4 When cooking is complete, turn the oven mode knob to the **Off** position.
- 5 Remove food from the oven.

NOTE

- It is normal for the convection fan to operate periodically throughout a normal bake cycle in the oven. This is to ensure even baking results.
- The convection fan may continue to run for a short time after the oven is turned off.

Baking Chart

This chart is only for reference and can be used for oven. Adjust the cook time according to your recipe.

Food	Oven Temperature	Rack position
Cakes		
- Layer cake	350 °F (175 °C)	3
- Bundt cake	350 °F (175 °C)	3
- Cupcakes	350 °F (175 °C)	3
- Pound cake	350 °F (175 °C)	3
- Carrot cake (from scratch)	350 °F (175 °C)	3
Cookies		
- Sugar cookies	350 °F (175 °C)	3
- Chocolate chip	350 °F (175 °C)	3
- Brownies	350 °F (175 °C)	3
Pizza		
- Rising	400 °F (204 °C)	5
- Frozen	400 °F (204 °C)	5
- Fresh	425 °F (218 °C)	5
Breads		
- Biscuits (canned)	350 °F (175 °C)	4
- Biscuits (from scratch)	375 °F (190 °C)	4
- Muffins	400 °F (204 °C)	4
Fruits and Vegetables		
- Apples (baked)	375 °F (190 °C)	2
- Potatoes (baked)	425 °F (218 °C)	2
Angel food cake	350 °F (175 °C)	1
Custards		
- Cheesecake, crème brûlée	325 °F (161 °C) 350 °F (175 °C)	2
Casserole		
- Frozen lasagna	375 °F (190 °C)	4

NOTE

- Because the oven temperature cycles, an oven thermometer placed in the oven cavity may not show the same temperature that is set on the oven.
- It is normal for the convection fan to run while preheating during a regular bake cycle.
- The convection fan motor may run periodically during a regular bake cycle.
- **The bake burner turns off if the door is left open during baking.** If the door is left open for longer than 30 seconds during baking, the bake burner turns off. The bake burner turns back on automatically once the door is closed.

Convection Mode

The convection system uses a fan to circulate heat evenly within the oven. This improves heat distribution and allows for even cooking and excellent results, especially when using multiple racks. Convection cooking can also shorten cooking times.

Convection Bake

Setting the Conv. Bake Function (example: to Conv. Bake 375 °F)

- 1 Turn the oven mode knob to select **Conv. Bake**.
- 2 Set the oven temperature: press **plus(+)** until 375 °F appears in the display.
 - Convection Bake cooks faster and more evenly when cooking foods like cookies, biscuits, rolls, or other baked goods on a single rack. Cookies, muffins, and biscuits will have very good results when using multiple racks.
 - Multiple rack cooking may slightly increase times for some foods, but the overall time is reduced.
 - Convection Bake gives excellent results for quick breads and yeast breads of all kinds, and breads and pastries brown more evenly.
 - Do not use Convection Bake for delicate items like custards, souffles, or cheesecakes, which may be disturbed by the convection fan.

NOTE

- The convection cooking modes automatically reduce the oven temperature by 25 °F (14 °C). The display shows the changed temperature.
- This feature is called auto conversion.
- The range comes with this feature enabled.
- To disable the auto conversion feature, see Setting Convection Auto Conversion, page 28.
- The oven fan runs while convection baking. If the door is left open for longer than 30 seconds during baking, the fan stops.

- 3 Press **Start**. The display shows **Conv. Bake** and the converted temperature starting at 100 °F. As the oven preheats, the displayed temperature will increase in 5-degree increments.
- 4 Once the oven reaches the desired temperature, a tone sounds and the oven light blinks on and off. The display shows the auto converted oven temperature 350 °F, **Conv. Bake** and .

Convection Baking Chart

If auto conversion is disabled, reduce standard recipe temperature by 25 °F (14 °C) for Convection Bake. Temperatures have been adjusted in this chart. Multi-rack cooking may slightly increase cook times for some foods, but the overall time is reduced. This chart is only for reference. Adjust cooking time according to your preference.

Food	Oven Temperature (converted)	Rack position
Cakes		
- Layer cakes	325 °F (161 °C)	3
- Bundt cakes	325 °F (161 °C)	3
Cakes, Specialty		
- Popovers	400 °F (204 °C)	3
- Cupcakes	325 °F (161 °C)	3
- Pound cakes	325 °F (161 °C)	3
Cookies		
- Sugar cookies	325 °F (161 °C)	3
- Chocolate chips	325 °F (161 °C)	3
- Brownies	325 °F (161 °C)	3
Pizza		
- Frozen	375 °F (190 °C)	5
- Fresh	400 °F (204 °C)	5
Breads		
- Biscuit, canned	325 °F (161 °C)	4
- Biscuit, from scratch	350 °F (175 °C)	4
- Muffins	375 °F (190 °C)	4
- White bread, loaf	400 °F (204 °C)	4
Pastry Crust		
- From scratch	400 °F (204 °C)	4
- Refrigerator	400 °F (204 °C)	4
Desserts		
- Fruit crisps and cobblers, from scratch	350 °F (175 °C)	3
- Pies, from scratch, 2 crust fruit	350 °F (175 °C)	3
Angel food cake	325 °F (161 °C)	1
Custards		
- Cheesecake, crème brûlée	300 °F (149 °C) 325 °F (161 °C)	2
Casserole		
- Frozen lasagna	350 °F (175 °C)	4

Cookware for Convection Cooking

Any cookware safe for use in a conventional oven will work in a convection oven. But for best results, keep the following in mind.

- Make sure pans don't touch the oven walls when centered on the racks. Use cookware that leaves room for air circulation in the oven for best results when convection cooking.
- Leave space between pans. Make sure pans don't touch each other or the oven walls.
- Do not use pans with high sides. Use flat pans with no sides for cookies or biscuits. Use a pan with low sides for oven-baked chicken.
- Metal pans heat the fastest. Heat-resistant paper and plastic containers that are recommended for use in regular ovens can be used in convection ovens. Glass and ceramic pans can also be used. However, metal pans heat the fastest and are recommended for convection cooking.
- Food cooked on pans with dark or matte finishes cooks faster than food on pans with shiny finishes.
- Use the pan size recommended in the recipe.

NOTE

- Some frozen foods have been developed to use commercial convection ovens. For best results in this oven, preheat the oven and use the temperature recommended on the packaging.
- If a food manufacturer gives specific convection cooking instructions, remember that convection autoconversion will reduce the set temperature by 25 °F (14 °C). If auto-conversion is enabled, add 25 °F (14 °C) when setting the temperature to get a resulting converted temperature which matches the recipe.

Convection Roast

The Convection Roast feature is designed to give optimum roasting performance. Convection Roast combines cooking with the convection fan to roast meats and poultry. The heated air circulates around the food from all sides, sealing in juices and flavors. Food cooked in this manner is crispy brown on the outside while staying moist on the inside.

Setting the Conv. Roast Function (example: to Conv. Roast 375 °F)

- 1 Turn the oven mode knob to select **Conv. Roast**.
- 2 Set the oven temperature: press **plus(+)** until 375 °F appears in the display.

NOTE

The convection cooking modes automatically reduce the oven temperature by 25 °F (14 °C). The display shows the changed temperature. This feature is called auto conversion. The range comes with this feature enabled. To disable the auto conversion feature, see Setting Convection Auto Conversion, page 28.

- 3 Press **Start**. The display shows **Conv. Roast** and the changing temperature starting at 100 °F. As the oven preheats, the displayed temperature will increase in 5-degree increments.
- 4 Once the oven reaches the desired temperature, a tone sounds and the oven light flashes on and off. The display shows the auto converted oven temperature 350 °F, **Conv. Roast** and .
- 5 Place food in oven.

Broil

Your oven is designed for closed-door broiling. Broil uses an intense heat radiation from the upper gas burner.

The Broil function works best when broiling thin, tender cuts of meat (1" or less), poultry or fish.

CAUTION

- Do not use a broiler pan without a grid. The oil can cause a grease fire.
- Do not cover the grid and broiler pan with aluminum foil. Doing so will cause a fire.
- Always use a broiler pan and grid for excess fat and grease drainage. This will help to reduce splatter, smoke, and flare-ups.
- Never use a broiler pan that is not thoroughly cleaned and at room temperature. If your broiler pan is damaged, warped, or has heavy permanent soiling, consider replacing it to reduce the amount of smoke you experience during broiling.

NOTE

- Use Lo broil to broil foods such as poultry and thick cuts of meat.
- Remove the pan from the oven to cool down for easy cleaning.
- For best results, use a pan designed for broiling, as shown below. The broiler pan will catch grease spills and the grid will help prevent grease splatters.

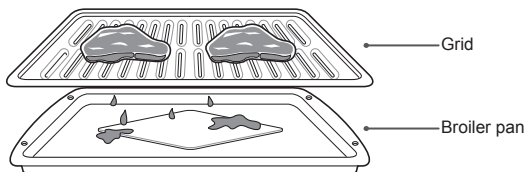

When broiling refer to the broiling guide for placing the rack.

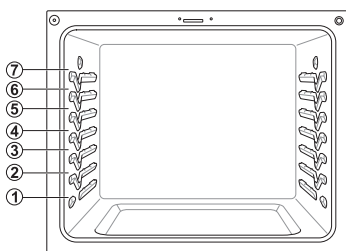

Setting the oven to Broil

- 1 Turn the oven mode knob to select **Broil High** or **Broil Low**.
- 2 Press **Start**.
- 3 Allow the broiler to preheat for five minutes.
- 4 Place food in the oven.
- 5 Close the oven door. The oven door must be closed during broiling.

WARNING

When using your broiler, the temperature inside the oven is extremely hot. Take caution to avoid possible burns by:

- Keeping the door closed when broiling
- Always wearing oven mitts when inserting/removing food items

Improper use of the broiler may result in excessive smoke or a grease fire. Improper use conditions include, but are not limited to:

- Broiling on heavy rack in position 6.
- Setting the broiler to a higher power level than recommended.
- Using dirty/greasy broiler pans.
- Broiling beyond recommended cooking times.

NOTE

- This range is designed for closed-door broiling. Close the door to set the Broil function. If the door is open, the Broil function cannot be set and **door** appears on the display. Close the door and reset the Broil function. Opening the door turns off the broil burner during broiling. If the door is opened during broiling, the broil burner turns off after five seconds. The broiler turns back on automatically once the door is closed.

- 6 When broiling is finished, turn the oven mode knob to the **Off** position.

NOTE

During any Broil function, it is normal for the broiler to cycle on and off. The igniter for the broil burner on the ceiling of the oven glows orange periodically during normal broil operation.

Recommended Broiling Guide

The size, weight, thickness, starting temperature, and your preference of doneness will affect broiling times. This guide is based on meats at refrigerator temperature. For best results when broiling, use a pan designed for broiling.

Food	Quantity and/or Thickness	Rack Position	First Side (minutes)	Second Side (minutes)	Comments
Ground Beef Well done	1 lb. (4 patties) 1/2 to 3/4" thick	6	5-7	3-4	Space evenly. Up to 8 patties may be broiled at once.
Beef Steaks					Steaks less than 1" thick cook through before browning. Pan frying is recommended. Slash fat.
Rare	1" thick 1 to 1 1/2 lbs.	6	7	5	
Medium		6	12	5-6	
Well Done		6	13	8-9	
Rare	1 1/2" thick 2 to 2 1/2 lbs.	4	10	6-7	
Medium		4	12-15	10-12	
Well Done		4	25	16-18	
Toast	1 to 9 pieces	5	1-2	1-2	
Chicken	1 whole 2 to 2 1/2 lbs., split lengthwise 4 bone-in breasts	2	35-40	25	Brush each side with melted butter. Broil skin-side down.
		2	25-30	10-15	
Fish Fillets	1/4 to 1/2" thick	5	7-8	6	Handle and turn very carefully. Brush with lemon butter before and during cooking, if desired.
Ham Slices (precooked)	1" thick 1/2" thick	3 4	10 7	5 4	Increase time 5 to 10 minutes per side for 1 1/2" thick or home-cured ham.
Pork chops Well Done	2 (1/2" thick) 2 (1" thick) about 1lb.	4 4	10 13	8 8-9	Slash fat.
Lamb Chops					Slash fat.
Medium	2 (1" thick) about 10 to 12 oz.	5	6	4-7	
Well Done		5	10	10	
Medium	2 (1/2" thick) about 1lb.	5	10	4-6	
Well done		5	17	12-14	
Bacon	1/2 lb. (about 8 thin slices)	4	8	3	Arrange in single layer.
Lobster Tails	2-4 6 to 8 oz. each	3	13-16	Do not turn over.	Cut through back of shell. Spread open. Brush with melted butter before broiling and after half of broiling time.

- This guide is only for reference. Adjust cook time according to your preference.

NOTE

The USDA advises that consuming raw or undercooked fish, meat, or poultry can increase your risk of food-borne illness.

The USDA has indicated the following as safe minimum internal temperatures for consumption:

- Ground beef, veal, pork, or lamb: 160 °F (71.1 °C)
- Poultry: 165 °F (73.9 °C)
- Beef, veal, pork, or lamb: 145 °F (62.8 °C)
- Fish / Seafood: 145 °F (62.8 °C)

Pizza

This function automatically sets the oven temperature to cook either frozen pizza with regular or rising crust, or freshly made pizza. Simply choose the type of pizza (see chart) and set the desired cook time.

Setting the Oven for Pizza

- 1 Turn the oven mode knob to select the **Pizza** mode. **P1** appears in the display. Press **plus(+)** or **minus(-)** repeatedly to toggle between the **P1**, **P2** and **P3** options. (See Pizza Chart below.)
- 2 Press **Start**. The oven starts to preheat.

As the oven preheats, the temperature is displayed and rises in 5-degree increments. Once the oven reaches the set temperature, a tone sounds and the oven light blinks on and off.

- 3 Place pizza in the oven, close the door and set the timer following the suggestions in the chart.
- 4 Turn the oven mode knob to the **Off** position to cancel Pizza at any time.
- 5 Remove the food from the oven.

NOTE

Preheating is necessary for better cooking results. Place the food in the oven after preheating.

Pizza Chart

Display Mode	Item	Rack position	Recommended time (minutes)
P1	Frozen pizza, Regular crust	5	14-16
P2	Frozen pizza, Rising crust	5	19-21
P3	Fresh Pizza	5	8-10

Warm

This function will maintain an oven temperature of 170 °F. The Warm function will keep cooked food warm for serving up to three hours after cooking has finished. The Warm function may be used without any other cooking operations.

Setting the Warm Function

- 1 Turn the oven mode knob to select **Warm**.
- 2 Press **Start**.
- 3 Turn the oven mode knob to the **Off** position when warming is finished.

NOTE

- The Warm function is intended to keep food warm. Do not use it to cool food down.
- It is normal for the fan to operate during the Warm function.

Proof

This feature maintains a warm oven for rising yeast leavened products before baking.

Setting the Proof Function

- 1 Use rack position 2 or 3 for proofing.
- 2 Turn the oven mode knob to select **Proof**.
- 3 Press **Start**.
- 4 Turn the oven mode knob to the **Off** position when proofing is finished.

NOTE

- To avoid lowering the oven temperature and lengthening proofing time, do not open the oven door unnecessarily. Check bread products early to avoid over proofing.
- Do not use the proofing mode for warming food or keeping food hot. The proofing oven temperature is not hot enough to keep foods at safe temperatures. Use the Warm feature to keep food warm. Proofing does not operate when the oven is above 125 °F. **Hot** shows in the display.
- It is normal for the fan to operate during the Proof function.

SMART FEATURES

Before Using Tag On

The Tag On function allows you to conveniently use LG Smart Diagnosis™, set the cook mode and EasyClean® features, and communicate with your appliance using a smart phone. To use the Tag On function:

- 1 Download the LG Smart Oven application to a smart phone.
- 2 Turn on the NFC (Near Field Communication) function in the smart phone. The Tag On function is only compatible with smart phones that are equipped with the NFC function and based on the Android 4.0 (Ice Cream Sandwich) or later OS (operating system).

Turning On the Smart Phone's NFC Function

- 1 Enter the **Settings** menu of the smart phone and select **Share & connect** under **WIRELESS NETWORKS**.



- 2 Set **NFC** and **Direct/Android Beam** to ON and select **NFC**.



- 3 Check **Use Read and Write/P2P receive**.



NOTE

- Depending on the smart phone manufacturer and Android OS version, the NFC activation process may differ. Refer to the manual of the smart phone for details.
- You can activate Tag On function by using the Android 4.0 smart phone with NFC function or higher. NFC function may not work depending on smart phones.

Using the Tag On Function

The Tag On Icon

Turn the oven mode knob to select **Tag On**. Look for the Tag On icon on the control panel. Position the smart phone next to the icon when using the Tag On function with the LG Smart Diagnosis™, cook mode setting and EasyClean® features of the LG Smart Oven application.

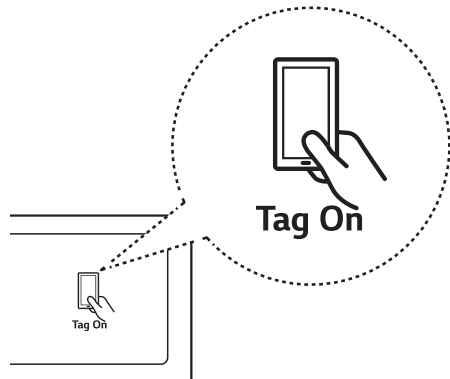

The NFC Antenna Position

When using the Tag On function, position the smart phone so that the NFC antenna inside the back of the smart phone matches the position of the Tag On icon on the appliance. (The position of the antenna cannot be seen, so the LG Smart Oven application will attempt to find it and display a target range for the antenna on the smart phone's screen.)

If the application is not able to show a target range, position the center back of the smart phone over the Tag On icon on the appliance. If the connection is not made immediately, move the smart phone very slightly in a widening circular motion until the application verifies the connection.

Because of the characteristics of NFC, if the transmission distance is too far, or if there is a metal sticker or a thick case on the phone, transmission will not be good.

Press [?] in the LG Smart Oven application for a more detailed guide on how to use the Tag On function.

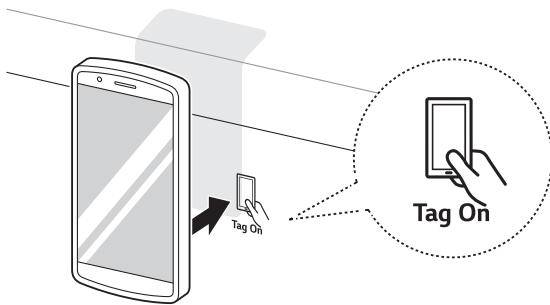

Using Tag On with Applications

Press an LG appliance's Tag On logo with an NFC-equipped smart phone to use the LG Smart Oven application's LG Smart Diagnosis™, Oven Settings, and EasyClean® features.

Smart Diagnosis™

Allows you to diagnose and troubleshoot problems with your range.

EasyClean®

Allows you to set EasyClean® alerts, read the instruction guide, and simulate and compare energy consumption when using EasyClean® versus self-clean cycles.

Oven Settings

Allows the user to change oven settings, including the hour mode, preheat alarm light, beeper volume, temperature units, convection auto conversion, and thermostat adjustment.

IMPORTANT : Features could be added or deleted when the LG Smart Oven application is updated. Data saved on the LG Smart Oven application could be deleted when the application is updated or your smart phone is changed.