

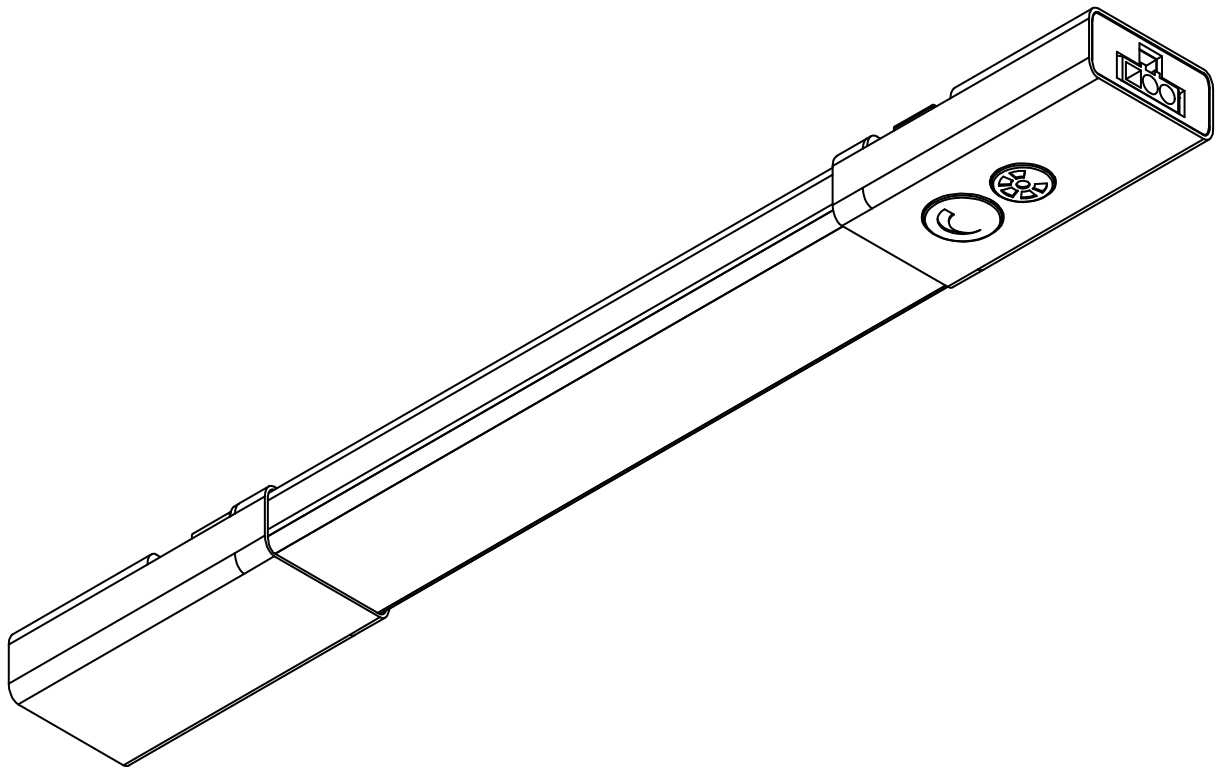

24 INCH UNDER CABINET LIGHT

FITS 24 IN. CABINETS (20 1/2 IN. TOTAL LENGTH)

IMPORTANT SAFETY INSTRUCTIONS AND INSTALLATION GUIDE



READ BEFORE INSTALLATION
SAVE THESE INSTRUCTIONS

Questions, problems, missing parts? Before returning to the store,
call Feit Electric Customer Service
8 a.m. - 5 p.m., PST, Monday - Friday

1-866-326-BULB (2852)

FEIT.COM

Table of Contents

Table of Contents	2
Safety Information	2
FCC Statement	2
Warranty	2
Pre-Assembly	3
Single LED Fixture Installation	4
Two or More LED Fixture Installation	5
Operating Instructions	6

Safety Information

SAVE THESE INSTRUCTIONS

IMPORTANT SAFEGUARDS:

ALWAYS FOLLOW BASIC SAFETY PRECAUTIONS WHEN USING ELECTRICAL PRODUCTS, ESPECIALLY WHEN CHILDREN ARE PRESENT.



CAUTION: Do not attempt to install while plugged in. This fixture is for indoor use only. Not for use with plastic cabinets. Do not install this fixture inside a totally enclosed cabinet. Do not mount over stoves.



WARNING: To avoid risk of electrical shock, always make sure the product is unplugged from the electrical outlet before assembling, disassembling, relocating, servicing or cleaning it.



CAUTION: Do not install this product in a wet location.



CAUTION: Do not install this product in an outdoor location.



CAUTION: Do not use chemical solvents or harsh abrasives to clean the fixture.

FCC STATEMENT

This device complies with part 15 of the FCC Rules. Operation is subject to the following two conditions:

(1) This device may not cause harmful interference, and (2) this device must accept any interference received, including interference that may cause undesired operation. Note: This equipment has been tested and found to comply with the limits for a Class B digital device, pursuant to part 15 of the FCC Rules. These limits are designed to provide reasonable protection against harmful interference in a residential installation. This equipment generates, uses and can radiate radio frequency energy and, if not installed and used in accordance with the instructions, may cause harmful interference to radio communications. However, there is no guarantee that interference will not occur in a particular installation. If this equipment does cause harmful interference to radio or television reception, which can be determined by turning the equipment off and on, the user is encouraged to try to correct the interference by one or more of the following measures: Reorient or relocate the receiving antenna. Increase the separation between the equipment and receiver. Connect the equipment into an outlet on a circuit different from that to which the receiver is connected. Consult the dealer or an experienced radio/TV technician for help. Any changes or modifications not expressly approved by the manufacturer could void the user's authority to operate the equipment. Feit Electric Company, 4901 Gregg Road, Pico Rivera, CA 90660. www.feit.com, 1-800-543-3348.

Limited Warranty

This product is warranted to be free from defects in workmanship and materials for up to 1 years from date of purchase. If the product fails within the warranty period, please contact Feit Electric at info@feit.com, visit feit.com/contact-us or call 1-866 326-BULB (2852) for instructions on replacement or refund. REPLACEMENT OR REFUND IS YOUR SOLE REMEDY. EXCEPT TO THE EXTENT PROHIBITED BY APPLICABLE LAW, ANY IMPLIED WARRANTIES ARE LIMITED IN DURATION TO THE DURATION OF THIS WARRANTY. LIABILITY FOR INCIDENTAL OR CONSEQUENTIAL DAMAGES IS HEREBY EXPRESSLY EXCLUDED. Some states and provinces do not allow the exclusion of incidental or consequential damages, so the above limitation or exclusion may not apply to you. This warranty gives you specific legal rights, and you may also have other rights which vary from state to state or province to province.

TOOLS REQUIRED

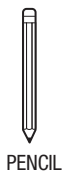
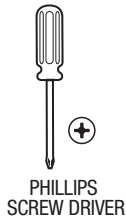

HARDWARE INCLUDED



NOTE: Hardware not shown to actual size.

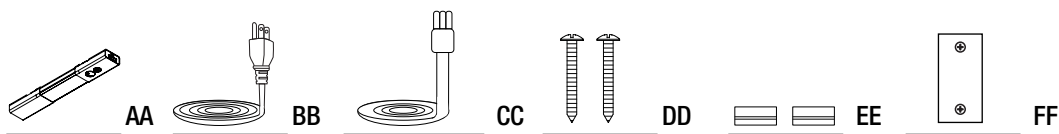

Part	Description	Quantity
AA	24in. LED Fixture	1
BB	72in. Electrical Plug	1
CC	18in. Connector Cable	1
DD	Mounting Screws	2
EE	Mounting Bracket	2
FF	Fixture Mounting Template	1

Item No.	Description	Volts (V)	Wattage Per Fixture (W)	Input Current (mA)	Maximum Linkable Units at 120V	Maximum Linkable Units with In-Wall Dimmer
UCL24/5CCT	24 Inch Under Cabinet LED Fixture	120	17	220	45	5

1 Position the Fixture

Find the desired place for the LED light fixture and mark clearly using the provided mounting bracket template (FF).

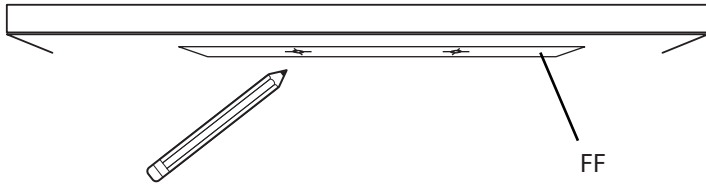

2 Installing the Mounting Bracket

Screw in the Mounting Brackets (EE) using the Mounting Screws (DD) on the marked locations.

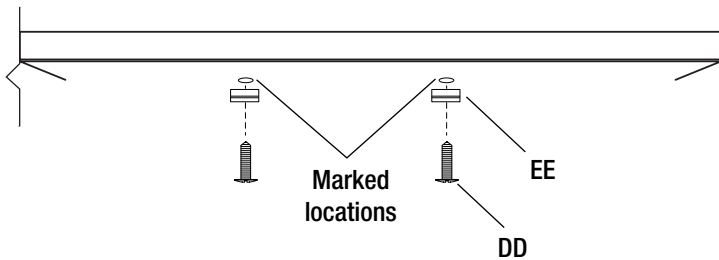

3 Installing the LED Fixture

Align and Snap LED Fixture (AA) on Mounting Brackets (EE).

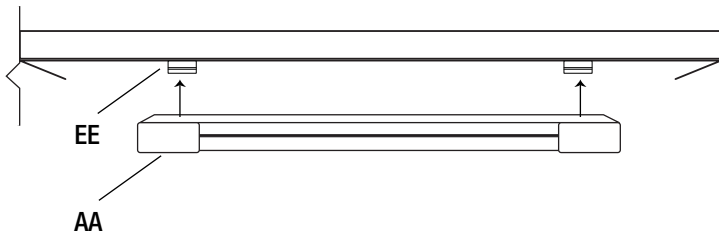

 **NOTE:** You can slide the LED Fixture (AA) left or right to adjust position.

4 Connecting the Electrical Plug

Plug in the Electrical Plug (BB) to the LED Fixture (AA).

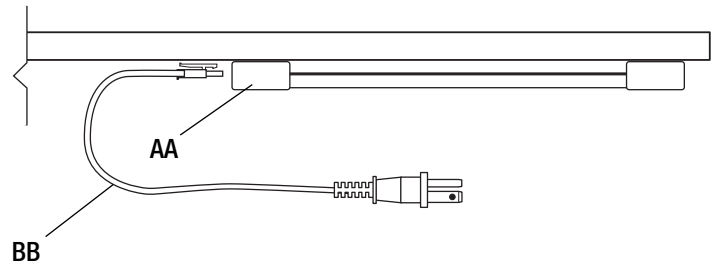

IMPORTANT: Do not plug in electrical plug to a wall power source until after connecting to the LED Fixture (AA).

5 Connecting to a Power Outlet

Connect the Electrical Plug (BB) to the power outlet on the wall.

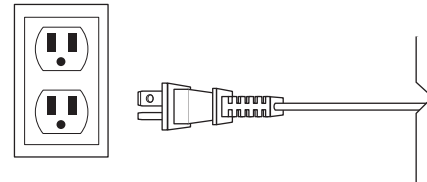

Two or More LED Fixture Installation

1 Position the Fixtures

Find the desired place for the LED light fixture and mark clearly using the provided mounting bracket template (FF).

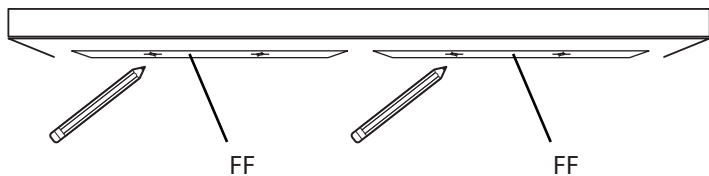

2 Installing the Mounting Brackets

Screw in the Mounting Brackets (EE) using the Mounting Screws (DD) on the marked locations.

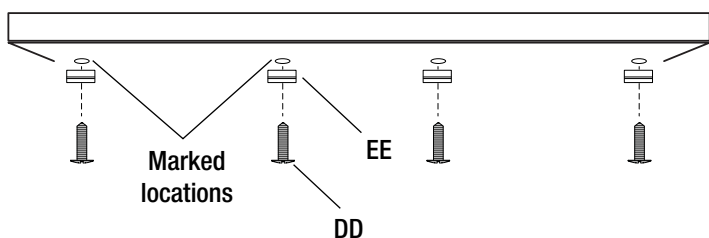

3 Installing the LED Fixtures

Align and snap the LED Fixtures (AA) on the Mounting Brackets (EE).

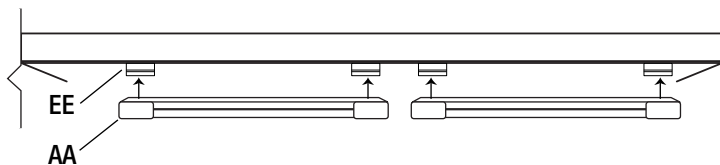

NOTE: You can slide the LED Fixture (AA) left or right to adjust position.

4 Linking the LED Fixtures

Connect the LED Fixtures (AA) using the provided Connector Cable (CC).

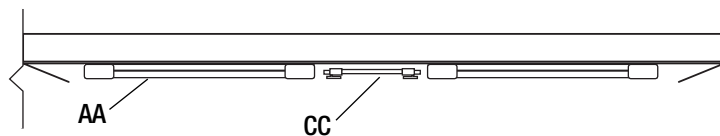

5 Connecting the Electrical Plug

Plug in the Electrical Plug (BB) to the linked LED Fixtures (AA).

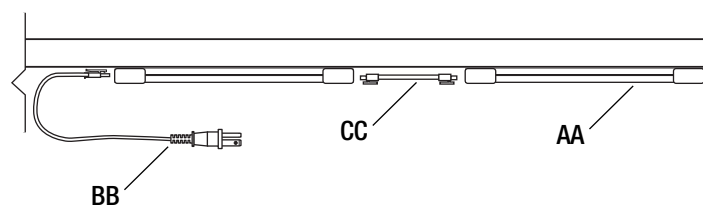

IMPORTANT: Do not plug in electrical plug to a wall power source until after connecting to the LED Fixture (AA).

6 Connecting to a Power Outlet

Connect the Electrical Plug (BB) to the power outlet on the wall.

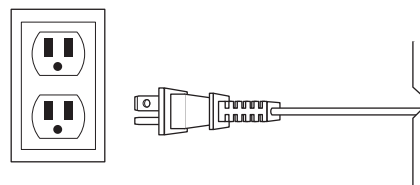



Use the ON/OFF and Dim Button for ON/OFF Operation and Changing the Dimming Levels

To select the desired dimming level, Cycle through Dimming levels (High, Medium, Low, Dim, Off) by pressing the Dim Button. This setting will be fixed each time the ON/OFF switch is turned ON.

Changing the Color Temperature Setting

To select the desired color temperature, cycle through 2700K - 3000K - 3500K - 4000K - 5000K by pressing the CCT Button. This setting will be fixed each time the ON/OFF switch is turned ON.

This LED Fixture has the feature to operate and control multiple units, even if they are not linked.

- To control multiple fixtures, Hold the CCT button for 3 seconds on all the fixtures to be controlled in a group.
- To remove the individual fixture from the group, Hold the CCT button on the fixture that you want to control individually for 3 seconds.