



INSTRUCTIONS D'ASSEMBLAGE
ASSEMBLY INSTRUCTIONS

MONARCH
SPECIALTIES INC.

I 7268

CHAISE DE BUREAU -
MECHE NOIR/DOSSIER-HAUT EXECUTIF CHROME

OFFICE CHAIR -
BLACK MESH / CHROME HIGH-BACK EXECUTIVE



POUR DE L'ASSISTANCE OU POUR COMMANDER
DES PIÈCES CONTACTEZ NOTRE DÉPARTEMENT
DE SERVICE À LA CLIENTÈLE.

FOR ASSISTANCE OR TO ORDER PARTS
CONTACT OUR CUSTOMER SERVICE DEPARTMENT

WWW.MONARCHSERVICE.COM

LISTE DES PIÈCES
PARTS LIST

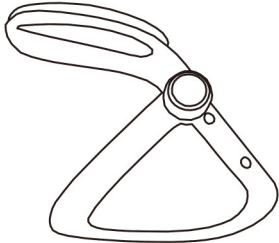
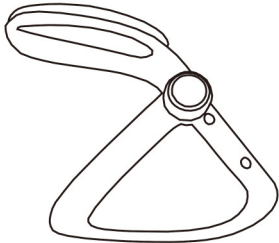
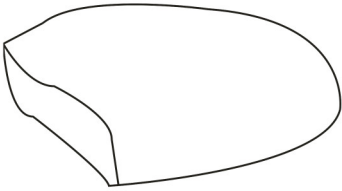
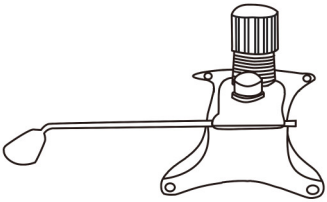
PIÈCE / PART #	IMAGE	DESCRIPTION	QTY / QTÉ
1		BACK REST DOSSIER	1
2		FRONT FACING LEFT ARMREST ACCOUDOIR AVANT GAUCHE	1
3		FRONT FACING RIGHT ARMREST ACCOUDOIR AVANT DROIT	1
4		CHAIR SEAT SIÈGE	1
5		CHAIR MECHANISM SEAT PLATE MÉCANISME DE SIÈGE	1

LISTE DES PIÈCES
PARTS LIST

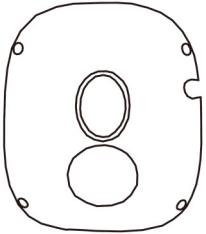
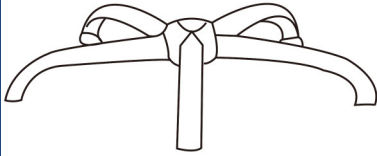
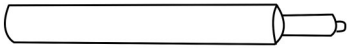
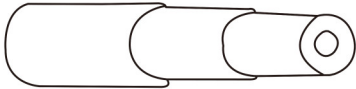
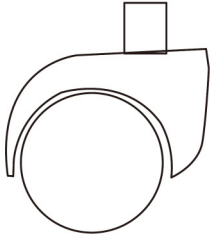
PIÈCE / PART #	IMAGE	DESCRIPTION	QTY / QTÉ
6		SEAT COVER HOUSSE DE SIÈGE	1
7		BASE BASE	1
8		GASLIFT ASCENSEUR À ESSENCE	1
9		TELESCOPIC COLUMN COVER COUVERTURE DE COLONNE TÉLÉSCOPIQUE	1
10		CASTOR ROULLETTE	5

LISTE DES PIÈCES
PARTS LIST

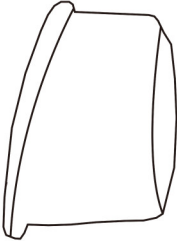
PIÈCE / PART #	IMAGE	DESCRIPTION	QTY / QTÉ
11		SCREW CAP CAPUCHON DE VIS	4

LISTE DES PIÈCES DE MONTAGE
HARDWARE LIST

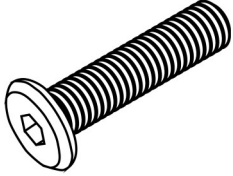
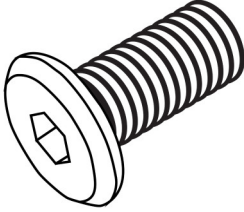
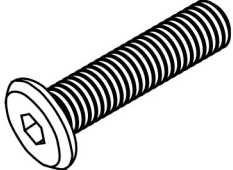
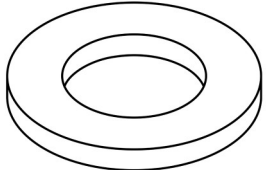
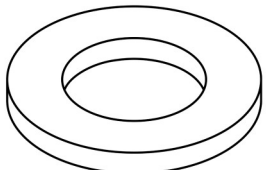
PIÈCE / PART #	IMAGE	DESCRIPTION	QTY / QTÉ
A		ASSEMBLING BOLT - Ø 1/4" X 1 1/2" BOULON D'ASSEMBLAGE - Ø 1/4" X 1 1/2"	4
B		ASSEMBLING BOLT - Ø 1/4" X 3/4" BOULON D'ASSEMBLAGE - Ø 1/4" X 3/4"	6
C		ASSEMBLING BOLT - Ø 1/4" X 1 1/8" BOULON D'ASSEMBLAGE - Ø 1/4" X 1 1/8"	2
D		METAL WASHER - Ø 1/4" X 1/2" RONDELLE DE MÉTAL - Ø 1/4" X 1/2"	4
E		METAL WASHER - Ø 1/4" X 3/4" RONDELLE DE MÉTAL - Ø 1/4" X 3/4"	8

LISTE DES PIÈCES DE MONTAGE
HARDWARE LIST

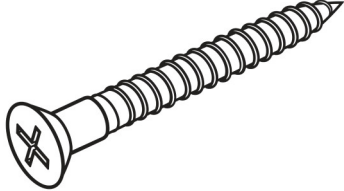
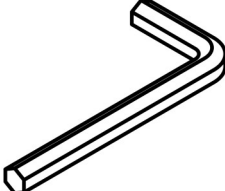
PIÈCE / PART #	IMAGE	DESCRIPTION	QTY / QTÉ
F		ASSEMBLING SCREW - Ø 1/4 X 5/8" VIS D'ASSEMBLAGE - Ø 1/4 X 5/8"	4
G		HEX KEY CLÉ HEXAGONALE	1

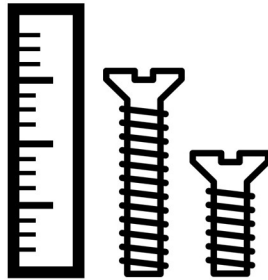

OUTIL DE VÉRIFICATION DE DIMENSIONS DES PIÈCES
HARDWARE DIMENSIONS VERIFICATION TOOL

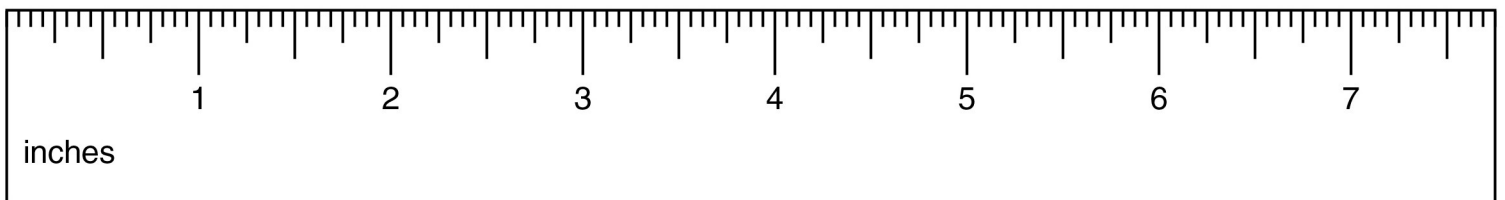

ÉTAPE / STEP 1

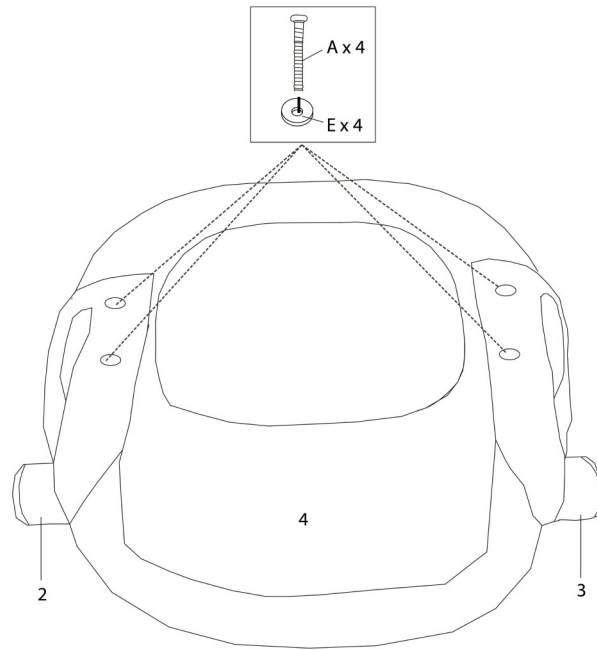

ÉTAPE / STEP 2

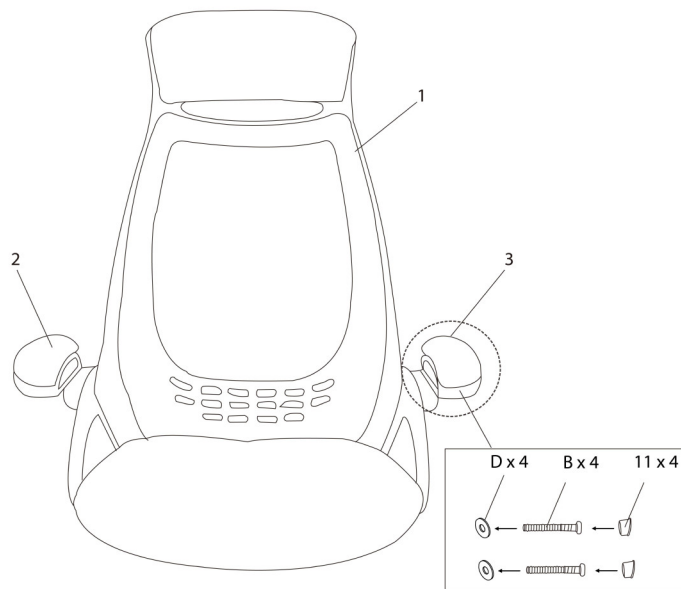

ÉTAPE / STEP 3

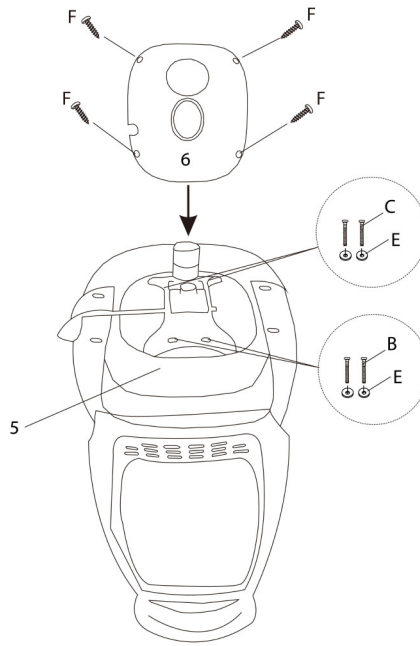

ÉTAPE / STEP 4

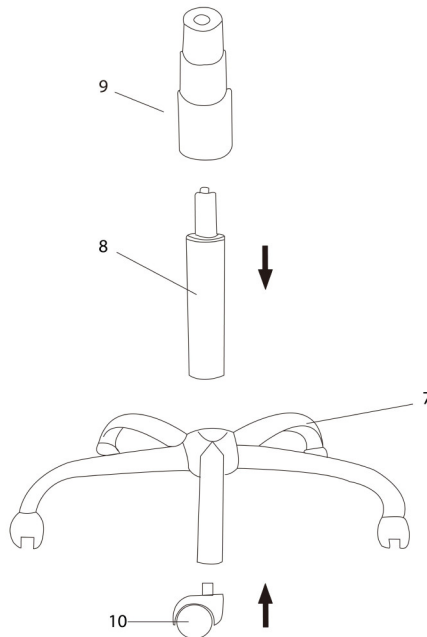

ÉTAPE / STEP 5

